

SIEMENS



Manual

SENTRON

3WL Air Circuit Breaker COM35
Communication Guide
PROFINET IO & Modbus TCP

Edition

03/2020

[siemens.com/SENTRON](https://www.siemens.com/SENTRON)

SIEMENS

SENTRON



Protection devices
3WL Air Circuit Breaker
COM35 Communication Guide
PROFINET IO, Modbus TCP
Equipment Manual

<u>Introduction</u>	1
<u>COM35</u>	2
<u>3WL accessories</u>	3
<u>Data library</u>	4
<u>Troubleshooting/FAQs</u>	5
<u>ESD Guidelines</u>	A
<u>List of abbreviations</u>	B

Legal information

Warning notice system

This manual contains notices you have to observe in order to ensure your personal safety, as well as to prevent damage to property. The notices referring to your personal safety are highlighted in the manual by a safety alert symbol, notices referring only to property damage have no safety alert symbol. These notices shown below are graded according to the degree of danger.

 DANGER
indicates that death or severe personal injury will result if proper precautions are not taken.
 WARNING
indicates that death or severe personal injury may result if proper precautions are not taken.
 CAUTION
indicates that minor personal injury can result if proper precautions are not taken.
NOTICE
indicates that property damage can result if proper precautions are not taken.

If more than one degree of danger is present, the warning notice representing the highest degree of danger will be used. A notice warning of injury to persons with a safety alert symbol may also include a warning relating to property damage.

Qualified Personnel

The product/system described in this documentation may be operated only by **personnel qualified** for the specific task in accordance with the relevant documentation, in particular its warning notices and safety instructions. Qualified personnel are those who, based on their training and experience, are capable of identifying risks and avoiding potential hazards when working with these products/systems.

Proper use of Siemens products

Note the following:

 WARNING
Siemens products may only be used for the applications described in the catalog and in the relevant technical documentation. If products and components from other manufacturers are used, these must be recommended or approved by Siemens. Proper transport, storage, installation, assembly, commissioning, operation and maintenance are required to ensure that the products operate safely and without any problems. The permissible ambient conditions must be complied with. The information in the relevant documentation must be observed.

Trademarks

All names identified by ® are registered trademarks of Siemens AG. The remaining trademarks in this publication may be trademarks whose use by third parties for their own purposes could violate the rights of the owner.

Disclaimer of Liability

We have reviewed the contents of this publication to ensure consistency with the hardware and software described. Since variance cannot be precluded entirely, we cannot guarantee full consistency. However, the information in this publication is reviewed regularly and any necessary corrections are included in subsequent editions.

Table of contents

1	Introduction	7
1.1	Reference documents	7
1.2	Technical Support	7
1.3	Advanced training courses	8
1.4	Security	8
1.4.1	Security information	8
1.4.2	Open Source Software	9
2	COM35	11
2.1	General	11
2.2	Properties	13
2.3	Commissioning	15
2.4	Connection of the COM35 module	16
2.5	Write protection (Write Enable)	21
2.6	Dynamic Arc Flash Sentry (DAS) – maintenance mode	24
2.6.1	Components required to implement the DAS function using a COM35 module	24
2.6.2	Circuit diagram	25
2.6.3	powerconfig commissioning and service software	26
2.6.4	Standards	26
2.6.5	Implementation examples	27
2.6.6	Parameter set B	29
2.6.7	Parameter assignment via communication	29
2.7	Circuit breaker position detection	30
2.8	Security functions	30
2.8.1	Protection of the network infrastructure	31
2.8.2	Hardware write protection	31
2.8.3	IP filter	32
2.8.4	IP white list	33
2.8.5	Configurable Modbus TCP port	35
2.8.6	Signed firmware	36
2.9	Resetting to factory settings	36
2.9.1	Function button	37
2.9.2	PROFINET	38
2.10	Firmware update	38
2.10.1	powerconfig	38
2.10.2	Firmware files	39

2.11	Time synchronization	40
2.11.1	Parameters.....	40
2.11.2	Synchronization.....	40
2.11.3	powerconfig.....	40
2.11.4	System time with SNTP	41
2.11.5	Automatic daylight saving change	43
2.12	COM35 in the ETU display	46
2.13	Event and trip log	47
2.14	Technical data.....	47
2.15	PROFINET IO	51
2.15.1	Performance features of the COM35 PROFINET module.....	51
2.15.1.1	Overview	52
2.15.1.2	Technical data of the communication interfaces.....	53
2.15.2	Parameterization/addressing	53
2.15.2.1	Metered values.....	53
2.15.2.2	Cyclic data traffic.....	57
2.15.3	Acyclic data traffic	66
2.15.3.1	Content of the data sets	66
2.15.3.2	Data set error telegrams	69
2.15.4	Alarm, error and system messages	70
2.15.4.1	Structure of the diagnostic message	70
2.15.4.2	Diagnostics/maintenance alarm messages	77
2.15.5	Hardware interrupt messages.....	78
2.16	Modbus TCP	79
2.16.1	Addressing	80
2.16.2	Function codes.....	80
2.16.3	Read Holding Registers	80
2.16.4	Write Multiple Registers	81
2.16.5	Read basic type data	81
3	3WL accessories	83
3.1	DSP800.....	83
3.2	TD400	85
3.2.1	Operator controls and interfaces.....	88
3.3	7KN POWERCENTER 3000.....	90
4	Data library	93
4.1	Chapter overview	94
4.2	Scaling	94
4.3	Units	95

4.4	Function classes	96
4.4.1	Function classes of the data points	96
4.4.2	Data points for controlling the SENTRON circuit breakers	96
4.4.3	Data points for detailed diagnostics of the SENTRON circuit breakers	97
4.4.4	Data points for identifying the SENTRON circuit breakers	99
4.4.5	Data points for measured values current	100
4.4.6	Data points for measured values voltage	101
4.4.7	Data points for measured values power	102
4.4.8	Data points for other measured values	103
4.4.9	Data points for the time stamp (TS) of the measured values	104
4.4.10	Primary protection function parameters	106
4.4.11	Enhanced protection function parameters	107
4.4.12	Alarm setpoint parameters (threshold alarms)	108
4.4.13	Communication and measurement parameters	109
4.5	Data sets for SENTRON WL	110
4.5.1	Difference between Modbus register number and register address	110
4.5.2	Data set DS 51: Main overview	110
4.5.3	Data set DS 53: Trip log	112
4.5.4	Data set DS 54: Event log	113
4.5.5	Data set DS 64: Data of the harmonics analysis	113
4.5.6	Data set DS 68: CubicleBUS Output Module Status	114
4.5.7	Data set DS 69: CubicleBUS Input Module Status	115
4.5.8	Data set DS 72: Min./max. measured metered value log	116
4.5.9	Data set DS 73: Min./max. measured values of the voltages	121
4.5.10	Data set DS 74: Min./max. measured values of the powers	124
4.5.11	Data set DS 76: Min./max. measured values of frequency and THD	126
4.5.12	Data set DS 77: Min./max. measured values of the temperatures	128
4.5.13	Data set DS 91: Statistical information	129
4.5.14	Data set DS 92: Diagnostic data	131
4.5.15	Data set DS 93: Controlling the circuit breakers	133
4.5.16	Data set DS 94: Current measured values	134
4.5.17	Data set DS 97: Detailed identification	141
4.5.18	Data set DS 100: Identification overview	144
4.5.19	Data set DS 128: Parameters of the metering function and enhanced protection function	145
4.5.20	Data set DS 129: Parameters of the protection function and settings for load shed threshold and load pickup	149
4.5.21	Data set DS 130: Parameters for the alarm setpoint values	154
4.5.22	Data set DS 131: Parameters to activate/deactivate extended protective functions and alarm setpoint functions	159
4.5.23	Data set DS 160: Parameters for communication	163
4.5.24	Data set DS 161: Parameters for communication	164
4.5.25	Data set DS 162: Device configuration	166
4.5.26	Data set DS 163: Profinet device name	167
4.5.27	Data set DS 165: Identification comment	167
4.5.28	Data set DS 166: IP white list	168
4.5.29	Data set DS 167: Daylight saving change	168

4.6	Formats	169
4.6.1	Formats of the data points	169
4.6.2	General data formats	169
4.6.3	Advanced protection functions formats.....	172
4.6.4	Special data formats	172
4.6.5	Data formats 15 to 24	174
4.6.6	Data formats 88 to 162	179
4.6.7	Data formats 307 to 373	187
4.6.8	Data formats 401 to 478	191
4.6.9	Data formats of the basic types	196
5	Troubleshooting/FAQs.....	199
A	ESD Guidelines	201
A.1	Electrostatic sensitive devices (ESD)	201
B	List of abbreviations.....	203
	Index.....	207

Introduction

Target readers of this documentation

The information contained in this documentation is provided for the benefit of:

- Designers
- Equipment manufacturers
- Commissioning engineers
- Users
- Maintenance personnel

1.1 Reference documents

You can find further details in the following documents:

Title	Article number
SENTRON WL - 3WL1 Circuit Breaker (IEC) Operating Instructions (https://support.industry.siemens.com/cs/ww/en/view/109761064)	9239996517
SENTRON WL - 3WL2 Low Voltage Insulated Case Circuit Breaker (NAFTA UL489) Operating Instructions (https://support.industry.siemens.com/cs/ww/en/view/21465740)	92399994174
SENTRON WL - 3WL3 Low Voltage Power Circuit Breaker (ANSI) Operating Instructions (https://support.industry.siemens.com/cs/ww/en/view/21463215)	92399984174

1.2 Technical Support

You can find further support on the Internet at:

Technical Support (<https://www.siemens.com/lowvoltage/technical-support>)

1.3 Advanced training courses

Find out about training courses on offer on the following link.

Training for Industry (<https://www.siemens.com/sitrain-lowvoltage>)

This is where you can choose from

- Web-based training courses (online, informative, free)
- Classroom training courses (course attendance, comprehensive, subject to fee).

You also have the possibility of compiling your own training portfolio via **Learning paths**.

1.4 Security

1.4.1 Security information

Siemens provides products and solutions with industrial security functions that support the secure operation of plants, systems, machines and networks.

In order to protect plants, systems, machines and networks against cyber threats, it is necessary to implement – and continuously maintain – a holistic, state-of-the-art industrial security concept. Siemens' products and solutions constitute one element of such a concept.

Customers are responsible for preventing unauthorized access to their plants, systems, machines and networks. Such systems, machines and components should only be connected to an enterprise network or the Internet if and to the extent such a connection is necessary and only when appropriate security measures (e.g. firewalls and/or network segmentation) are in place.

For additional information on industrial security measures that may be implemented, please visit (<https://www.siemens.com/industrialsecurity>).

Siemens' products and solutions undergo continuous development to make them more secure. Siemens strongly recommends that product updates are applied as soon as they are available and that the latest product versions are used. Use of product versions that are no longer supported, and failure to apply the latest updates may increase customer's exposure to cyber threats.

To keep up to date with all the latest product updates, subscribe to the Siemens Industrial Security RSS Feed at (<https://www.siemens.com/industrialsecurity>).

1.4.2 Open Source Software

This product, solution or service ("Product") contains third-party software components. These components are Open Source Software licensed under a license approved by the Open Source Initiative (<https://www.opensource.org>) or similar licenses as determined by SIEMENS ("OSS") and/or commercial or freeware software components. With respect to the OSS components, the applicable OSS license conditions prevail over any other terms and conditions covering the Product. The OSS portions of this Product are provided royalty-free and can be used at no charge.

If SIEMENS has combined or linked certain components of the Product with/to OSS components licensed under the GNU LGPL version 2 or later as per the definition of the applicable license, and if use of the corresponding object file is not unrestricted ("LGPL Licensed Module", whereas the LGPL Licensed Module and the components that the LGPL Licensed Module is combined with or linked to is the "Combined Product"), the following additional rights apply, if the relevant LGPL license criteria are met: (i) you are entitled to modify the Combined Product for your own use, including but not limited to the right to modify the Combined Product to relink modified versions of the LGPL Licensed Module, and (ii) you may reverse-engineer the Combined Product, but only to debug your modifications. The modification right does not include the right to distribute such modifications and you shall maintain in confidence any information resulting from such reverse-engineering of a Combined Product.

Certain OSS licenses require SIEMENS to make source code available, for example, the GNU General Public License, the GNU Lesser General Public License and the Mozilla Public License. If such licenses are applicable and this Product is not shipped with the required source code, a copy of this source code can be obtained by anyone in receipt of this information during the period required by the applicable OSS licenses by contacting the following address:

Siemens AG
Smart Infrastructure
Low Voltage Products
Technical Support
Postfach 10 09 53
93009 Regensburg
Germany

You will find Technical Support under (<https://www.siemens.com/lowvoltage/technical-support>).

Keyword: Open Source Request (please specify Product name and version, if applicable)

SIEMENS may charge a handling fee of up to 5 EUR to fulfil the request.

Warranty regarding further use of the Open Source Software

SIEMENS' warranty obligations are set forth in your agreement with SIEMENS. SIEMENS does not provide any warranty or technical support for this Product or any OSS components contained in it if they are modified or used in any manner not specified by SIEMENS. The license conditions may contain disclaimers that apply between you and the respective licensor. For the avoidance of doubt, SIEMENS does not make any warranty commitment on behalf of or binding upon any third-party licensor. The Open Source Software used in the product and the license agreements concerning this software can be found in the `Readme_OSS`.

COM35

2.1 General

The COM35 is one of the communication modules for the 3WL air circuit breaker. The COM35 is part of the circuit breaker internal CubicleBUS system and provides the following functions together with other CubicleBUS nodes:

- Read out circuit breaker data
- Set parameters
- Opening/closing the circuit breaker
- Reading out maintenance information
- Communication status, alarms and warnings

The COM35 supports the PROFINET IO and Modbus TCP communication protocols. The two protocols can be used simultaneously and independently. It is not necessary to configure which protocol will be used. This makes it possible to use the circuit breaker in different systems simultaneously (e.g.: energy management and process control).

Use of only one protocol is also possible.

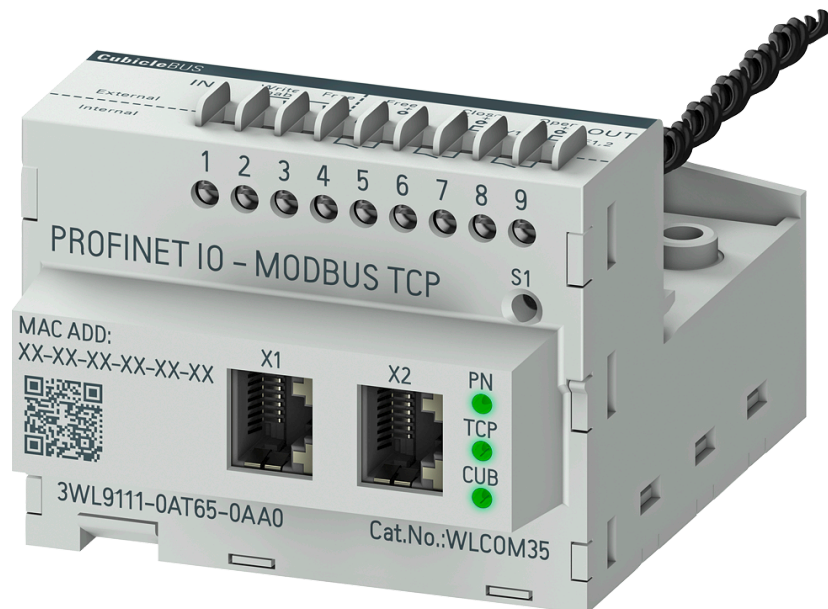











Figure 2-1 COM35

Displays





































The COM35 has three LEDs to display the states of the COM module and the communication interfaces.

Table 2- 1 LED displays

LED	Display	Meaning
PROFINET IO (PN)	Green 	<ul style="list-style-type: none"> Normal PROFINET IO communication Communication with PROFINET IO controller
	Flashing green 	Active communication only with PROFINET IO supervisor
	Red 	<ul style="list-style-type: none"> No communication with PROFINET IO controller No communication with PROFINET IO supervisor
Modbus TCP (TCP)	Green 	At least one opened Modbus TCP connection
	Flashing green 	<ul style="list-style-type: none"> Ethernet link available No Modbus TCP connection
	Off 	No Ethernet link available
CubicleBUS (CUB)	Green 	<ul style="list-style-type: none"> CubicleBUS node active Metering function/metering function PLUS or ETU active
	Flashing green 	<ul style="list-style-type: none"> CubicleBUS node active No metering function/metering function PLUS and no ETU found
	Red 	CubicleBUS communication with fault
	Off 	No CubicleBUS nodes active

Special operating states of the COM35 are signaled by the LEDs

Table 2- 2 LED displays for special operating states

Display	Meaning						
<table border="1"> <tr> <td>PN</td> <td></td> </tr> <tr> <td>TCP</td> <td></td> </tr> <tr> <td>CUB</td> <td></td> </tr> </table>	PN		TCP		CUB		PN and TCP LED flash alternately green, CUB LED is off
PN							
TCP							
CUB							
<table border="1"> <tr> <td>PN</td> <td></td> </tr> <tr> <td>TCP</td> <td></td> </tr> <tr> <td>CUB</td> <td></td> </tr> </table>	PN		TCP		CUB		PN and TCP LED flash alternately red, CUB LED flashes red
PN							
TCP							
CUB							
<table border="1"> <tr> <td>PN</td> <td></td> </tr> <tr> <td>TCP</td> <td></td> </tr> <tr> <td>CUB</td> <td></td> </tr> </table>	PN		TCP		CUB		PN and TCP LED flash alternately green, CUB LED flashes green
PN							
TCP							
CUB							
<table border="1"> <tr> <td>PN</td> <td></td> </tr> <tr> <td>TCP</td> <td></td> </tr> <tr> <td>CUB</td> <td></td> </tr> </table>	PN		TCP		CUB		All LEDs light up orange
PN							
TCP							
CUB							
	Visual identification that the COM35 is active. The identification period ends automatically after 10 s. You can terminate identification before this time by pressing the function button.						
	Replace device. The COM35 is not operable.						
	Restricted operation. The COM35 is starting or shutting down.						
	The device is restarting after a reset or after the auxiliary voltage has been switched on. The display is shown for 1 s.						

2.2 Properties

Security

Control/write access to the circuit breaker can be prevented via hardware or software functionality. Applying this functionality will prevent operation via communication (remote operation) or modification of parameters.

You will find further information on this in Chapter AUTOHOTSPOT.

Integral clock

An integral clock adds a time stamp to all events (such as minimum and maximum measured values, warnings, and trips). This clock can be synchronized.

You will find further information on this in Chapter Time synchronization (Page 40).

Temperature sensor

- The COM35 has an integral temperature sensor that provides only the approximate temperature in the cubicle thanks to its installation location outside the circuit breaker.
- The BSS also contains a temperature sensor that shows the temperature in the circuit breaker.
- The two temperature sensors are calibrated in the factory and do not require further calibration.
- The two temperature sensors may also be warmed by the surrounding electronic components, so the sensed temperatures may differ from the actual ambient temperatures.

Circuit breaker position detection

The following circuit breaker positions in the guide frame are detected via three built-in micro-switches on the underside of the COM35.

- Connected position
- Test position
- Disconnected position
- Not present

The circuit breaker position can be read out via communication.

The circuit breaker can be communicated with only in the connect and test positions. When the circuit breaker is in the disconnect position or not present, circuit breaker information will be unavailable but the COM35 will continue to communicate.

Switch function

The COM35 has two Ethernet ports (100BASE-T) with a switch function. These can be used to connect additional PROFINET or Modbus TCP devices in a daisy-chain fashion.

Function button

The function button can be used to return the COM35 to the factory settings.

Technical data

The COM35 is part of the circuit breaker. Unless stated otherwise, the technical data of the circuit breaker applies.

You will find further information on this in Chapter Technical data (Page 47).

Ambient temperatures

The 3WL circuit breakers are suitable for use in any climate in accordance with IEC 60068-2-30.

They are intended for use in enclosed rooms in which no severe operating conditions (such as dust, caustic vapors, hazardous gases) prevail.

When installed in dusty and damp areas, suitable enclosures must be provided.

Installation location

The COM35 is part of the circuit breaker and is installed in the auxiliary conductor terminals at position X7.

The auxiliary conductor terminals X7 cannot be used together with a COM35.

Standards and specifications

The COM35 is part of the circuit breaker. Unless stated otherwise, the technical data of the circuit breaker applies.

You will find further information on this in Chapter Technical data (Page 47).

2.3 Commissioning

Modbus TCP

First commissioning must be performed using the powerconfig software. This is only possible if COM35 has been activated with 24 V DC.

- The COM35 can be connected via an Ethernet interface to a PC/notebook and powerconfig and be found and parameterized via the search function of powerconfig (Page 38).
- The COM35 can be connected with the TD400 via the front connector of the ETU to a PC/notebook with powerconfig, found using the search function of powerconfig and parameterized.

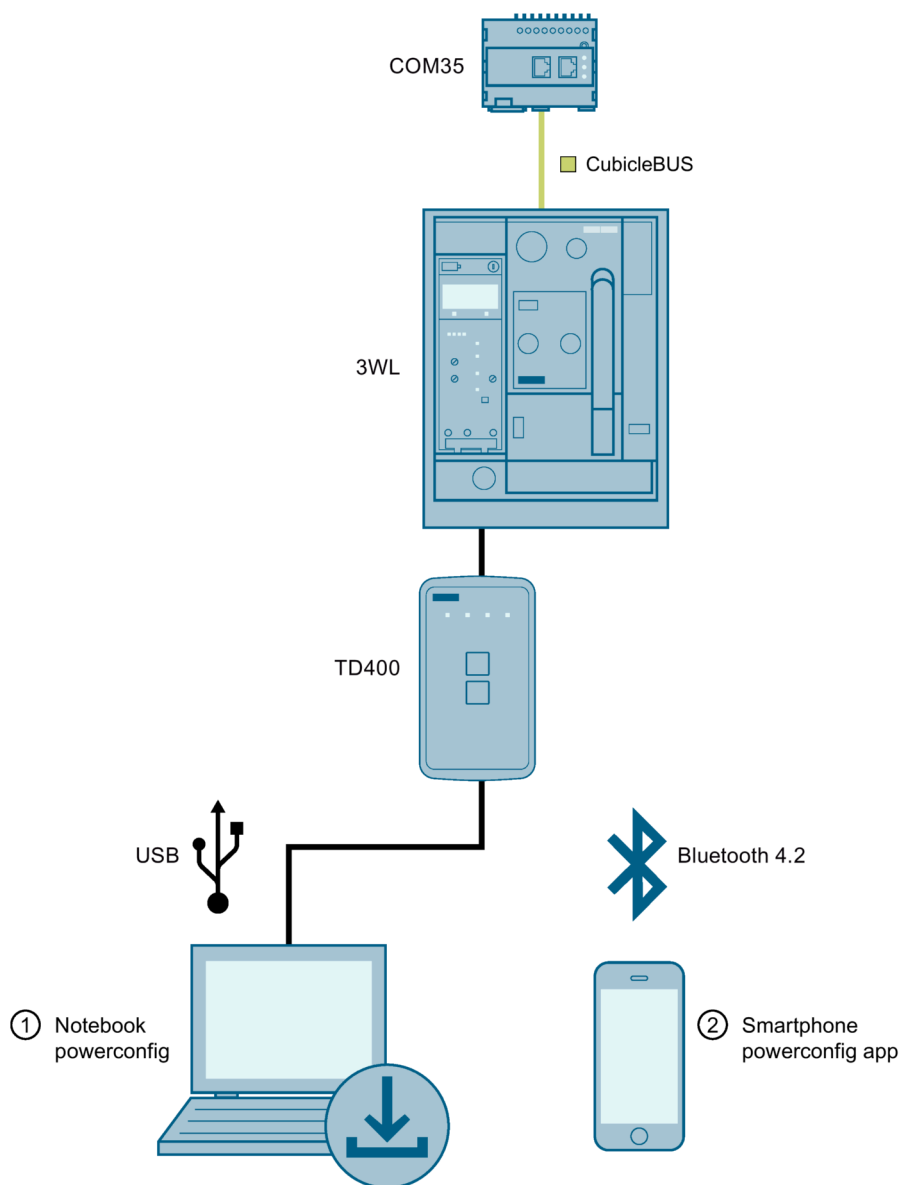

PROFINET

The COM35 supports the standard commissioning function of PROFINET (e.g. with a GSDML file (<https://support.industry.siemens.com/cs/ww/en/view/109763831>)).

2.4 Connection of the COM35 module

The COM35 is connected by plugging it into position X7 of the auxiliary conductor plug-in system. You will find further information in the circuit breaker operating instructions stated in Chapter Reference documents (Page 7).

Terminal assignment

The figure below shows the inscription on the COM35, the external terminal assignment for connecting the closing coil, the shunt release, write protection via communication, and the free input/output.

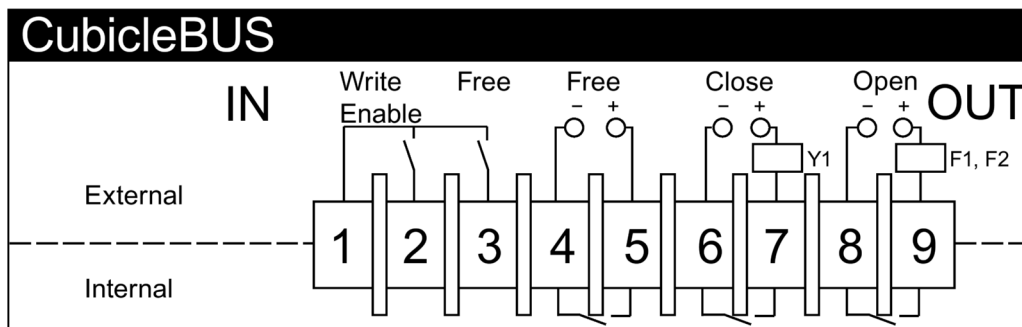

Figure 2-2 Terminal labeling of the COM35

Electrical connection to the CubicleBUS

The electrical connection to the circuit breaker and the CubicleBUS connection to the CubicleBUS nodes inside the circuit breaker (ETU, BSS, metering function) must be established. For this purpose, the four wires (two twisted pair) brought out of the rear of COM35 are connected to position X8 of the auxiliary conductor plug-in system.

Further components and connections

- The COM35 will directly control opening and closing coils rated for 24 V DC operation. If it is desired to use coils rated for a voltage greater than 24 V DC, interposing/coupling relays must be used.
- If the second auxiliary/shunt trip coil (F2, F3, F4) is used instead of the first auxiliary trip coil (F1) to open the breaker via COM35, the connection points X5:11 and X5:12 must be used.
- The free output can have one of three functions assigned to it:
 - General purpose remote controlled output connected to a fan, indicator, remote reset solenoid (only with option K10, automatic reset of the trip solenoid, standard in N. America) or other load requiring 24 V DC or less.
 - Secondary trip indicator output (bell alarm) – the output will activate when the trip unit has tripped the breaker.
 - Dynamic Arc Flash active indicator – active when parameter set B is in operation. The assignment of function to the User Output is done through powerconfig or remotely via communication. Note that all loads connected to the User Output must be powered by 24 V DC or less.

Note

Observe the polarity.

- With other voltages, interposing/coupling relays must be used.

The CubicleBUS connection for RJ45 plugs to which the external CubicleBUS modules can be connected is located on the rear. If no external CubicleBUS module is connected, the terminating resistor supplied in the form of an RJ45 plug must be used.

Please note that the rear RJ45 connection is not an Ethernet port, but a CubicleBUS port.

The User Input may be used either as a general-purpose input whose status can be communicated or to activate the Dynamic Arc Flash system by switching from Parameter Set B. You will find further information on this in Chapter Dynamic Arc Flash Sentry (DAS) – maintenance mode (Page 24).

See also

Connection of the COM35 module (Page 16)

Closing/opening the circuit breaker via the communication system

The figure below shows how COM35 must be wired with the auxiliary plug-in contacts to allow opening/closing via communication.

Note

COM35 input and output are rated for use with 24 V DC maximum.

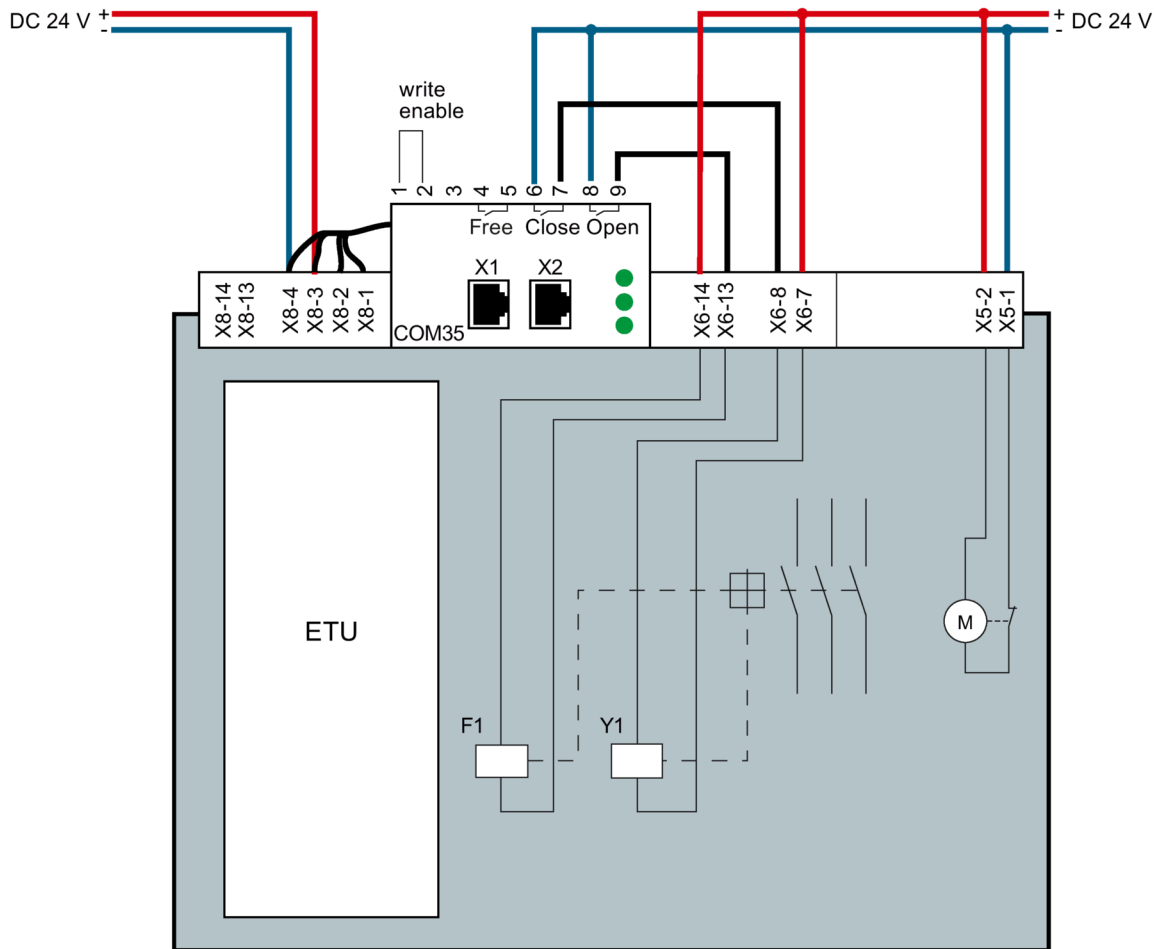

Figure 2-3 Wiring of COM35 for 24 V DC supply voltage

Note

The Write Enable input (terminals 1 & 2) must be connected together to allow remote configuration. Without this jumper, remote commands to change parameters, open/close, etc., will be ignored by the COM35.

The figure below shows the wiring if contacts are installed with voltages not equal to 24 V DC.

- Interposing/coupling relays must be used.
- If F1 is not used for switching off, the connection points X5:11 / X5:12 must be connected for F2 to F4.

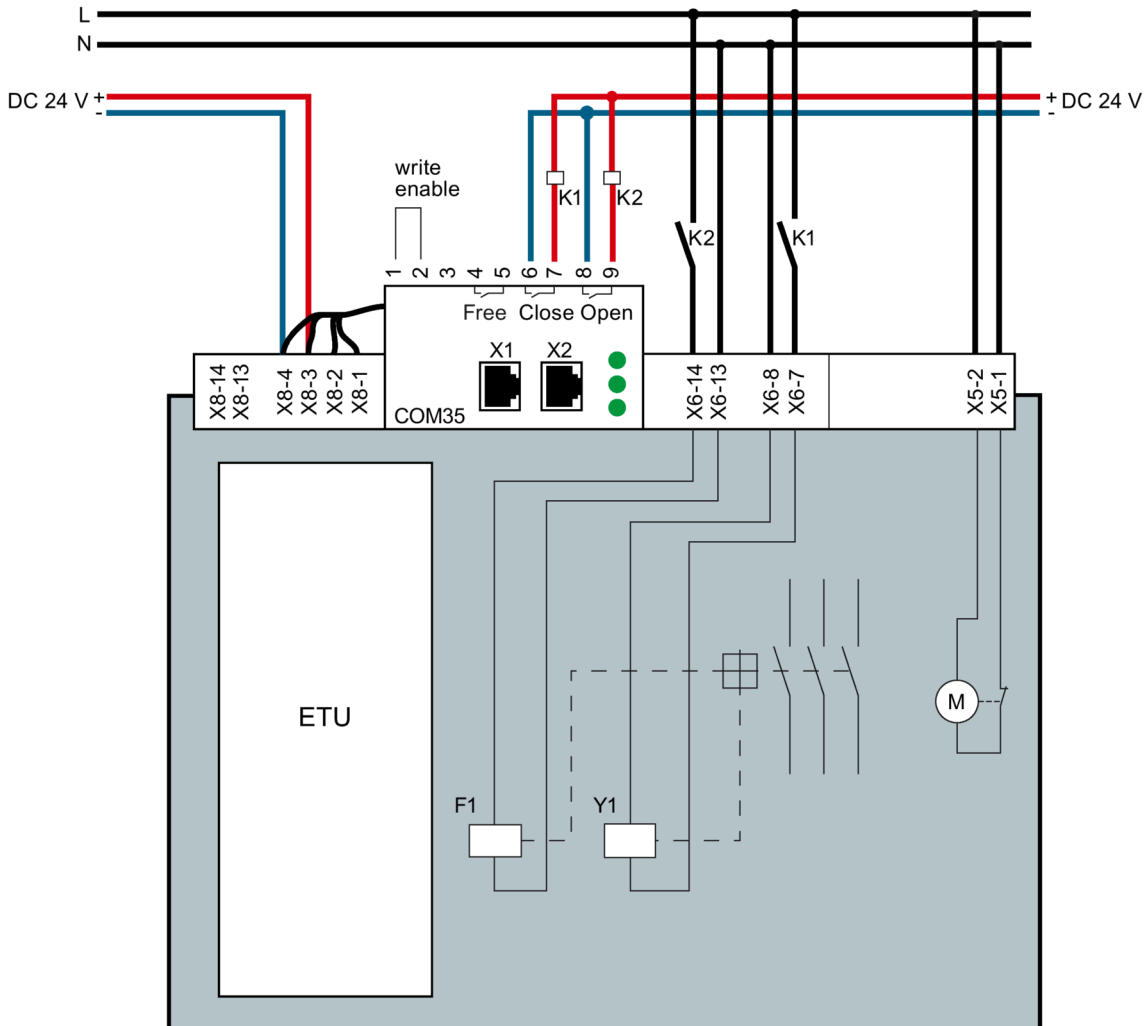

Figure 2-4 Wiring of COM35 for voltages higher than 24 V DC

RJ45 connection

The figure below shows COM35 from behind. It shows the RJ45 connection for the external CubicleBUS modules. If no external CubicleBUS module is connected, the bus must be terminated with the terminating resistor supplied.

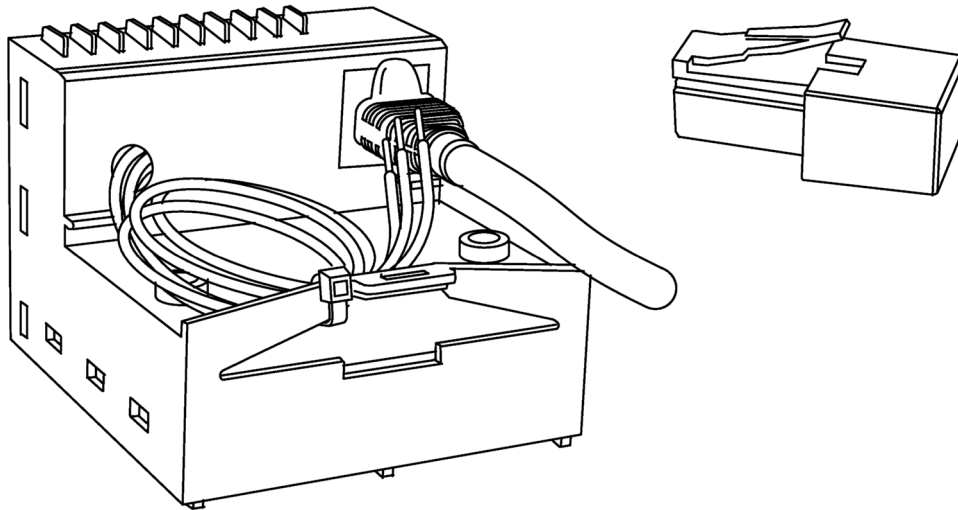

Figure 2-5 COM35 with RJ45 connection for CubicleBUS modules

Connection of the CubicleBUS nodes

The four black wires (two twisted pair) that are brought out of the COM35 must be connected to terminal strip X8 as shown below. The COM35 is connected with the nodes on the CubicleBUS in the circuit breaker in this way.

Table 2- 3 Terminal strip connection X8 between COM35 and CubicleBUS nodes

Meaning	Position and printing on the cable
CubicleBUS -	X8:1
CubicleBUS +	X8:2
+24 V DC	X8:3
Ground 24 V DC	X8:4

2.5 Write protection (Write Enable)

Disable write access

In applications in power distribution, it is often necessary to disable write access via communication interfaces temporarily or permanently. There is a hardware input on the COM35 for this purpose. Terminal 1 provides a 24 V DC output which, when connected to Terminal 2, disables remote write to parameters and open/close operations (Write Enable).

When the input is open (delivery condition of the COM35), write protection is active and modifications and actions are always locked.

The following actions are possible while write-protection is active:

The exceptions are the following modifications and actions that are also permitted in write-protected mode:

- Modifying/setting of trigger functions for the waveform buffer
- Reading out the contents of the waveform buffer
- Changing the parameters for threshold values
- Setting/changing the system time
- Modifying the free texts (comment, plant identifier)
- Resetting the min./max. values
- Resetting the settings to factory settings with function button S1, see Chapter Resetting to factory settings (Page 36).

The following actions are disallowed while write-protection is active:

All other modifications/actions are blocked, e.g.:

- Closing/opening the circuit breaker via communication
- Resetting the current tripping operation
- Modification of the protection parameters
- Modification of the parameters for the enhanced protection function/metering function
- Modification of the parameters for communication
- Changing the parameters for measured value setting/metering function
- Resetting maintenance information (counter)
- Control of digital outputs
- Updating of the firmware of the COM35 via the powerconfig software
- Modification of the function of the free user input/output (e.g. trip alarm switch/DAS)
- Resetting the settings to factory settings via PROFINET, see Chapter Resetting to factory settings (Page 36).

Write protection application

With write protection, it is possible to prevent closing/opening of the circuit breaker and modification of parameters. This protection can be temporary or permanent.

Write protection on/off

- Pin 1 and 2 of the COM35 open = write protection is activated.
- Pin 1 and 2 of the COM35 closed = write protection is deactivated.

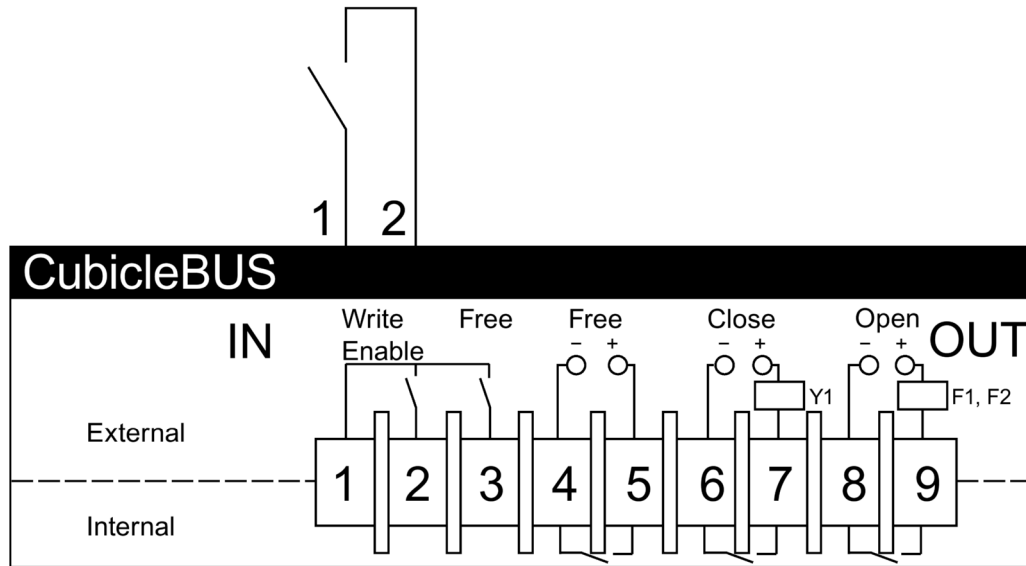

Figure 2-6 Write protection on/off

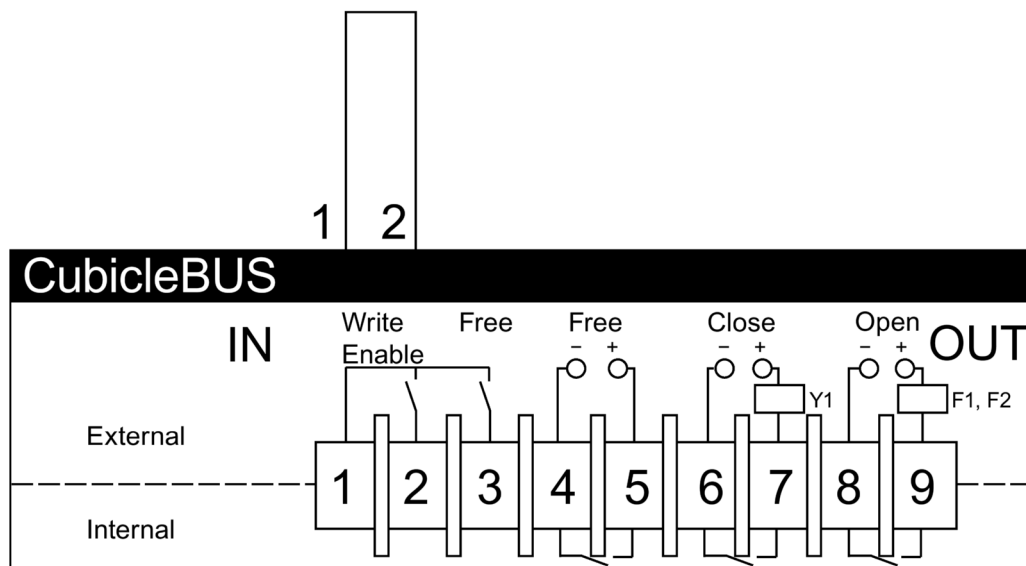

Figure 2-7 Write protection off

Temporary protection

- Door switch

To protect service personnel during maintenance work, it is possible to prevent the circuit breaker from being operated via communication while the switchgear door is open.

- Selector switch

It is possible to put a selector switch in the switchgear door. In this way, you can choose whether remote operation/parameterization will be possible or whether you would like to prevent or permit it temporarily.

- Security

The write protection is a very secure way of preventing impermissible operation and modification of parameters. You can temporarily enable (if you require it yourself) or disable remote operation/parameterization by a second independent path (e.g. by the PLC).

Transfer of necessary information

Despite the write protection, all the necessary information can be transferred, but the status of the circuit breaker cannot be changed.

All non-disabled actions are used only for remote diagnostics.

2.6 Dynamic Arc Flash Sentry (DAS) – maintenance mode

DANGER

Hazardous voltage.

Will cause death, serious personal injury, or equipment damage.

Turn off and lock out all power supplying the equipment before working on the device.

Install all covers before applying power.

Installation and maintenance must be performed by qualified personnel.

An arc-flash can be described as an arcing electrical current flowing through unintended dynamic paths.

Arc-flash events typically result from:

- Human error – such as accidental contact with voltages above ground potential, tools or debris inadvertently left behind post-maintenance, or improper assembly.
- Lack of adequate maintenance for the operating or environmental conditions.
- Insulation breakdown due to age or environmentally-related degradation, or operation beyond the product ratings.

After an arc initiates, it typically consumes its surroundings by ionizing air and converting metallic materials to conductive plasma, expanding exponentially in volume with explosive force and extreme heat. The more material consumed, the stronger the arc, and the less predictable its path becomes.

To achieve better personnel protection from arc-flash when they are working around energized equipment, it is important to trip circuit breakers as fast as possible to extinguish the arc. To achieve this, the DAS system uses the second parameter set of the ETU76B/776 to reduce the instantaneous trip threshold in order to trip the breaker at a lower level than would be required for normal operation.

The following section describes how this is accomplished.

2.6.1 Components required to implement the DAS function using a COM35 module

The following components are required to implement DAS functionality with a 3WL breaker:

- Circuit breaker
 - IEC: 3WL1 with electronic trip unit ETU76B
 - UL489: 3WL2 with electronic trip unit ETU776
 - UL1066: 3WL3 with electronic trip unit ETU776
- COM35 PROFINET IO - Modbus TCP communication module

2.6.2 Circuit diagram

Connections to the COM35 communication module for the DAS maintenance mode:

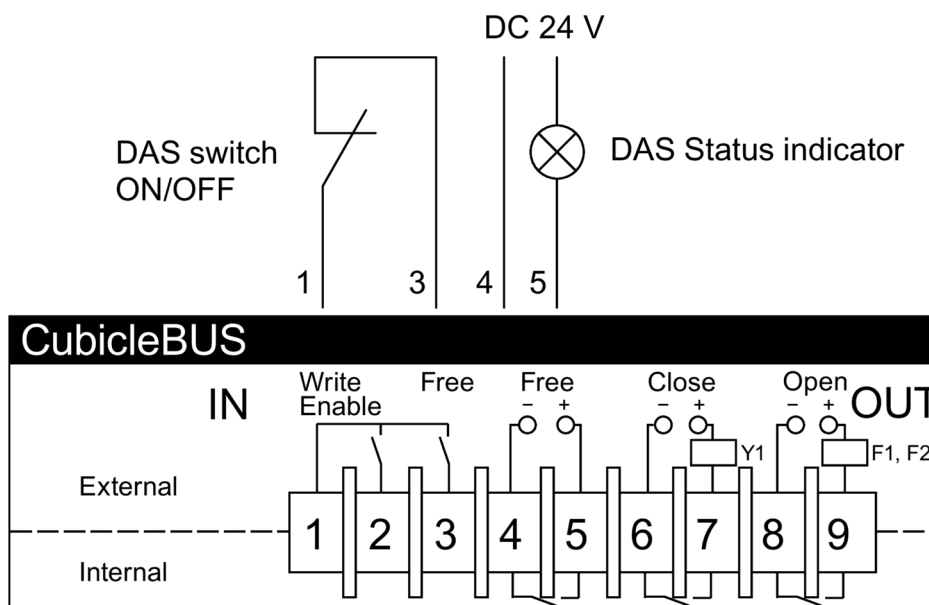

Figure 2-8 DAS circuit diagram

DAS maintenance mode is activated via terminals 1 and 3 on the COM35. A normally-closed contact is used for control. This means that DAS maintenance mode is active when the terminals are open.

Note

Unlike the digital CubicleBUS module, the COM35 uses a normally-closed contact to activate Parameter Set B containing the parameters for DAS mode.

2.6.3 powerconfig commissioning and service software

As delivered, neither the COM35 module nor the ETU76B/776 are configured for DAS. Both must be configured prior to use. The COM35 is configured to switch parameter sets and indicate DAS mode is active using powerconfig (version 3.11 and later). The maintenance mode parameters in Parameter Set B can be configured via powerconfig or from the front panel of the trip unit.

Note

If the COM35 is used to activate DAS mode (switch to Parameter Set B), it is not possible to switch between parameter sets via any other means (from the front panel of the trip unit, via communications or via a CubicleBUS input module).

Configuring the COM35 to change parameter sets gives the COM35 User Input absolute priority over this function.

2.6.4 Standards

DAS maintenance mode is an energy-reducing maintenance mode, providing local status indication, used to comply with the following standards:

- National Electrical Code (NEC) Section 240.87 (B)(3) Arc-Flash energy reduction (Energy-reducing maintenance switching with local status indicator)
- NFPA 70E Standard for Electrical Safety in the Workplace
- DIN EN 50110-1 Operation of electrical installations/B.6 Arc hazard

2.6.5 Implementation examples

To better protect personnel when they are in the vicinity of energized electrical equipment, the trip unit is switched to the B parameter set which has been set per a coordination study to the appropriate instantaneous pickup setting.

The following figures show how 3WL and 3VA circuit breakers can be connected to switch from normal operating parameters (Parameter Set A) to maintenance parameters (Parameter Set B).

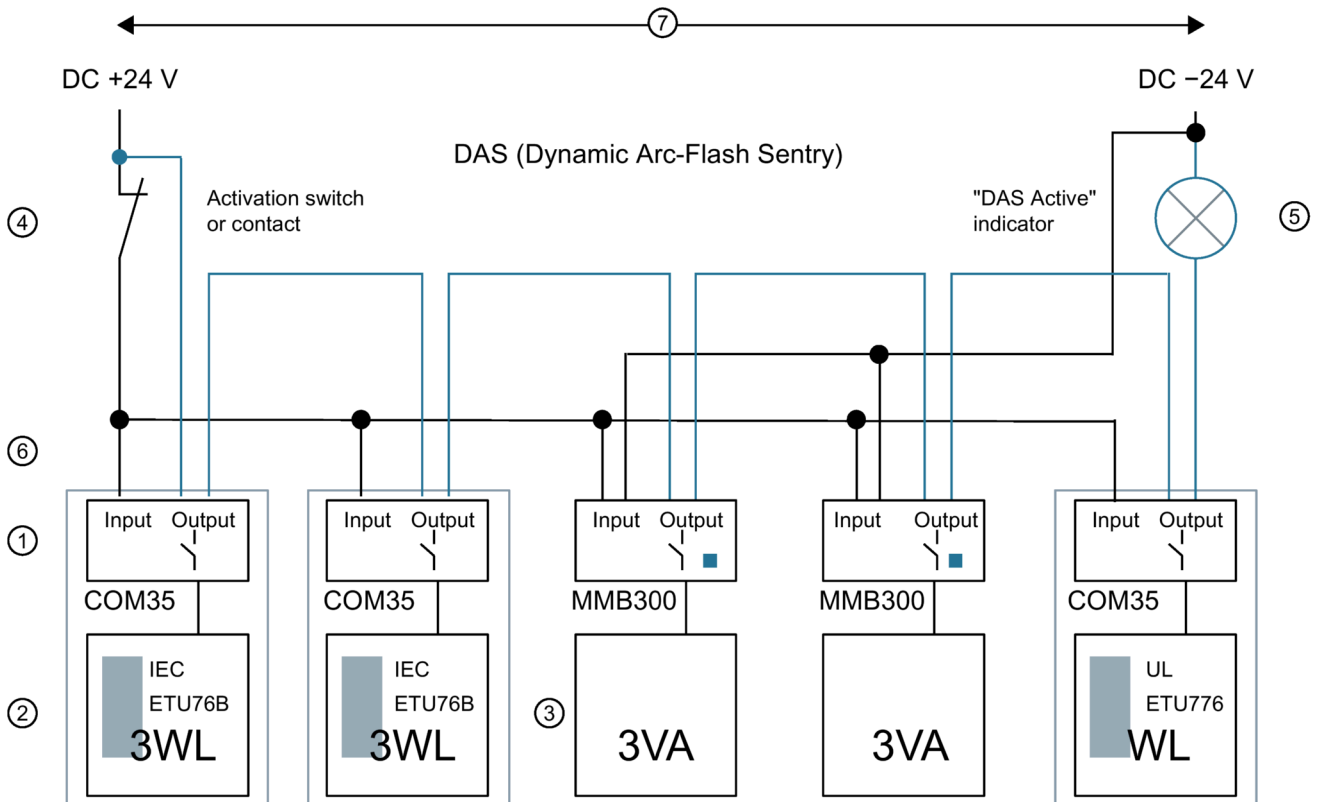

Figure 2-9 Example showing connections required for a combined 3WL/3VA DAS system using a 24 V DC supply for both activating and indication.

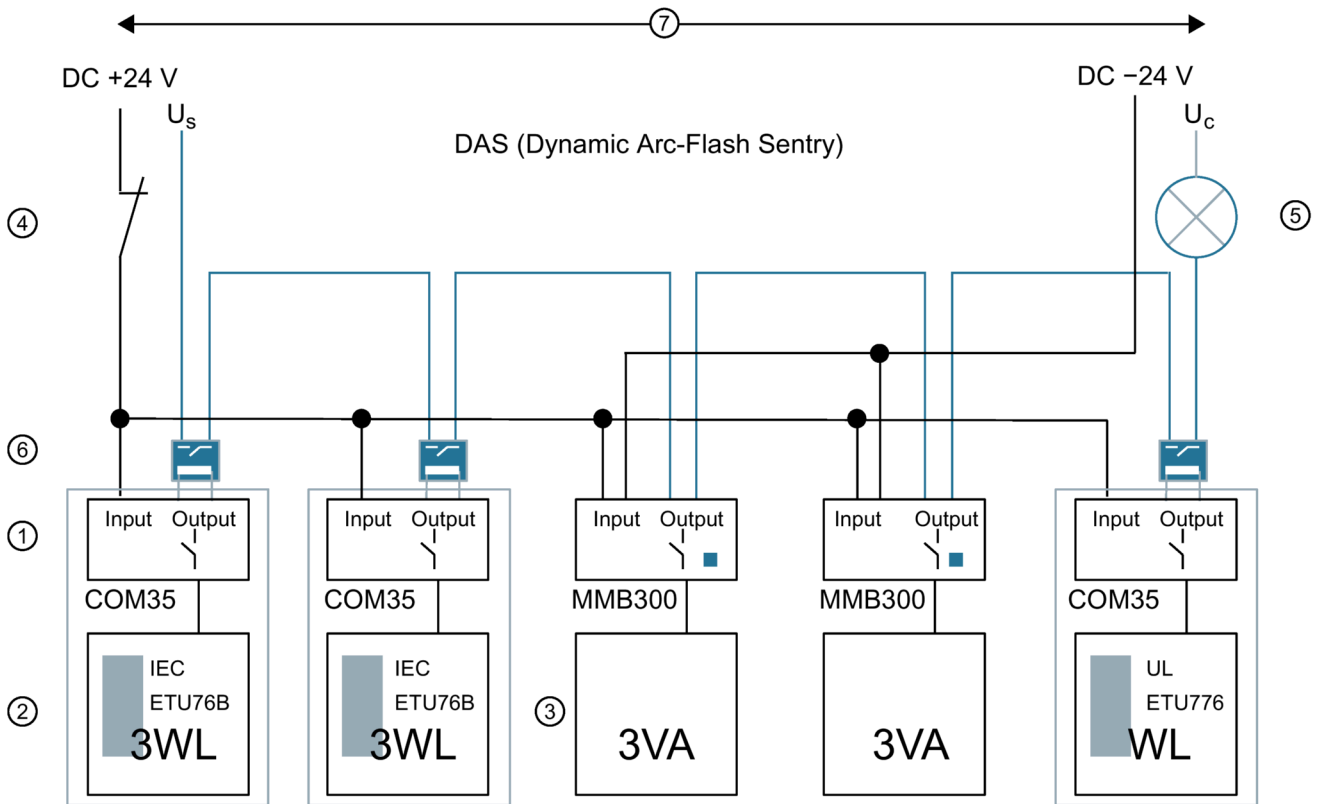

Figure 2-10 Example showing connections required to use an indicator requiring a voltage > 24 V DC using interposing/coupling relays.

- ① The COM35 communication module with the DAS maintenance mode.
Parameter set B of the ETU is activated via the free input of the COM35. The free output provides DAS Active status indication. The activated DAS maintenance mode has priority and overrides all other commands for changing over the parameter sets.
The DAS function is not active when the circuit breaker with the COM35 communication module is delivered and must be parameterized using the powerconfig software.
- ② The set DAS protection parameters are activated by changing over to the second parameter set (parameter set B) of the ETU76B/ETU776 of the 3WL air circuit breaker. Parameter set B configured with the powerconfig software or the ETU display.
- ③ In DAS maintenance mode, 3WL air circuit breakers and 3VA molded case circuit breakers can be used together with MMB300.
- ④ Open/close switch for activating DAS maintenance mode.
The circuit breaker must be a normally-closed contact (NO) and installed in a convenient location outside the arc flash zone.
- ⑤ The "DAS active" light should be mounted such that it is easily visible. The indicator is only active when all circuit breakers are in DAS maintenance mode. The output of the COM35 can supply 1 A (< 40 °C) or 400 mA (70 °C). To drive larger loads, an interposing/coupling relay must be used.
- ⑥ For voltages greater than 24 V DC an interposing/coupling relay must be used.
- ⑦ To ensure proper performance, the total cable length of the DAS system must not be longer than 50 m/165 ft.

2.6.6 Parameter set B

The ETU76B and ETU776 have two independent parameter sets A and B.

The ETU can be configured from the display or with the powerconfig commissioning and service software.

The parameter set A must contain the set values and delays required for protection of the power distribution system. The protection parameters must be determined by qualified personnel (e.g. with the SIMARIS design planning tool).

For parameter set B, the set values of parameter set A are adopted and adapted for DAS maintenance mode. The parameters must be chosen such that the possible accidental arc energy is reduced and there is no deliberate delay in short-circuit protection.

2.6.7 Parameter assignment via communication

For the DAS function, the free user input and the free user output can be parameterized via data point 478 in data set 161:

- Free user input: Parameter set switching
- Free user output: Parameter set indication

WARNING

Risk of serious injury due to re-parameterization

The operator must ensure that the function of the programmable input and output is not changed via communication when the DAS function is being used. Re-parameterization can be prevented using write-protection.

2.7 Circuit breaker position detection

The COM35 module has three micro-switches on the underside for determining the position of a withdrawable circuit breaker in the guide frame. Depending on which micro-switch is operated, the position of the circuit breaker in the guide frame is communicated (1 = operated).

The table below states the definition of the position:

Table 2- 4 COM35 Micro-switch

Circuit breaker position	Micro-switch at rear (S46)	Micro-switch at center (S47)	Micro-switch at front (S48)
Connected position	1	0	0
Test position	0	1	0
Disconnected position	0	0	1
Circuit breaker not available	0	0	0

When the circuit breaker is moved, the micro-switch that has been operated is released before the next micro-switch is operated. No micro-switch is operated in the intervening period. As far as communication is concerned, this means that when the circuit breaker is moved, the "old" status is communicated until a new defined status is reached. If the circuit breaker is in an intermediate position for an extended period of time, the message "Breaker not available" is output.

In the case of fixed-mounted circuit breakers, the mounting plate contains a spring plunger which presses on the switch which indicates connected position.

2.8 Security functions

The COM35 provides security functions that, together with the security functions of other network components, provide a security concept for your power distribution.

Note

COM35 should only be used in closed networks. We recommend using the security functions described below.

2.8.1 Protection of the network infrastructure

In addition to the use of the security functions of the COM35, the network infrastructure in which the 3WL is operated should also be protected, for example, by blocking certain ports in an external firewall. You will find further information on this in Chapter AUTOHOTSPOT.

Table 2- 5 Port list

Port type	Port number (decimal)	Service	Explanation
TCP	502 (default, but freely configurable)	Modbus TCP	The Modbus TCP port should be blocked in the gateway to another network if no Modbus TCP connection to the 3WL from this network is required.
UDP	161	SNMP	This service is required for operation of the PROFINET IO interface.
	17008, 17009	Device detection and commissioning	These ports are used by powerconfig and powermanager for commissioning the COM35. These ports should be locked when transitioning to another network (e.g. in a router firewall).
	34964	PROFINET RPC Endpointmapper	This service is required for operation of the PROFINET IO interface.
	49152 ... 49155	PROFINET RPC Device Server	

2.8.2 Hardware write protection

The hardware write protection on the COM35 is a very secure and simple security function. The write protection can prevent write and breaker open/close operations via communication and is active by default in the factory settings.

You will find further information in Chapter Write protection (Write Enable) (Page 21).

2.8.3 IP filter

Switching operations or parameter changes via Modbus TCP from another subnet can be prevented by the IP filter.

If the IP filter of the COM35 is active, the COM35 compares each time a connection is established via Modbus TCP whether the IP address of the remote station is in the same subnet as the COM35. If this is not the case, the remote station only gets restricted access rights. Accesses via PROFINET IO remain unrestricted.

The following actions, among others, are then prevented:

- Closing/opening the circuit breaker via communication
- Resetting the current tripping operation
- Modification of the protection parameters
- Modification of the parameters for the enhanced protection function/metering function
- Modification of the parameters for communication
- Changing the parameters for measured value setting/metering function
- Resetting of maintenance information (e.g. counters)
- Activating the digital outputs
- Updating of the firmware of the COM35 via the powerconfig software
- Modification of the function of the free user input/output (trip alarm/DAS)
- Resetting the settings to factory settings with PROFINET
- Changing the parameters for threshold values
- Setting/changing the system time
- Modifying the free texts (comment, plant identifier)
- Resetting the min./max. values

The IP filter can be activated/deactivated via Modbus TCP or PROFINET. In the factory settings/as-delivered state, the IP filter is deactivated.

2.8.4 IP white list

COM35 provides various security functions to protect the 3WL circuit breaker from unauthorized access via the communication.

The security functions can restrict the scope of functions (changing parameters, switching the circuit breaker on and off) for unauthorized clients.

Security functions are:

- Write protection (hardware write protection on the COM35)
- IP filter
- IP white list

The IP white list is a security function for restricting access to the circuit breaker via Modbus TCP.

The IP white list is used to grant individual IP addresses or address ranges privileged access to the 3WL. Addresses that are not included in the white list are automatically granted restricted access only.

Restricted access blocks the Modbus write functions. This means that neither can parameters be changed, nor the circuit breaker switched using the Modbus TCP.

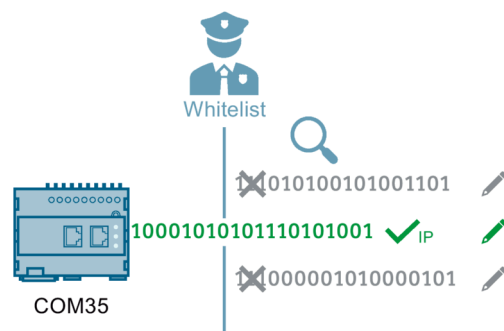

Requirements

- COM35 firmware version 1.1.0 and higher
- As an option for commissioning, powerconfig software version 3.13 and higher
- White list parameters can only be changed if COM35 write protection (hardware write protection on COM35) has been deactivated.

Setting values

The white list for the 3WL has the following setting values.

- White list IP addresses: List of permitted IP addresses
- Authorization status for IP filters or white list: Read out authorization status for the current client IP address

Data points

Modbus register number*			Description	Data point	Source WL	Format	Length (bits)	Scaling
Dec	Hex	High/Low						
42499	0xA603	–	White list IP addresses	508	COM35	Format (508)	1600	–
42599	0xA667	–	Authorization status	524	COM35	unsigned int	16	–
42600	0xA668	LOW	Property byte (white list IP addresses)	580	COM35	PB	8	–
42600	0xA668	HIGH	Property byte (authorization status)	524	COM35	PB	8	–

* Modbus address = Modbus register - 1

Parameter formats

White list (format 508)

The white list is configured using data point 523 (DS166). The white list contains 20 entries (filter) comprising:

- client IPv4 address (U32)
- address mask (U32)
- activation bit/access control bit field (U16)

The client address in combination with the address mask defines the criteria for granting privileged access rights to an external address.

As soon as the activation bit is deleted (0), the filter is deactivated and no longer evaluated. If the client address is zero in a filter, the filter is deactivated and no longer evaluated. If all filters are deactivated, the entire table is not evaluated.

The white list intervenes in the IP filter. Filters in white list are only active if the IP filter is deactivated. White list and IP filter cannot be simultaneously active.

White list table (format 508)

	" OFFSET [byte] "	Bit	Meaning
Filter 1	0...3	—	Client IP address
	4...7	—	AddressMask
	AccessRights		
	8...9	15	Filter on (1) / of (0)
	8...9	14 ... 1	reserved
8...9	0	set to 1 (full access)	
Filter 2	10...19	—	
Filter 3	20...29	—	
Filter 4	30...39	—	
Filter 5	40...49	—	
Filter 6	50...59	—	
Filter 7	60...69	—	
Filter 8	70...79	—	
Filter 9	80...89	—	
Filter 10	90...99	—	
Filter 11	100...109	—	
Filter 12	110...119	—	
Filter 13	120...129	—	
Filter 14	130...139	—	
Filter 15	140...149	—	
Filter 16	150...159	—	
Filter 17	160...169	—	
Filter 18	170...179	—	
Filter 19	180...189	—	
Filter 20	190...199	—	

Authorization status for IP filter or white list

The authorization status is used to read out the white list status of the current connection.

- 1 means privileged access to COM35
- 0 means restricted access to COM35

If an error occurs, the authorization status can clarify why no write actions are possible.

2.8.5 Configurable Modbus TCP port

The TCP port number for Modbus TCP connections is configurable and can be changed from the default 502 for use with hosts requiring port numbers > 1024 (such as Linux).

2.8.6 Signed firmware

Firmware updates of the COM35 are digitally signed by Siemens and therefore protected against manipulation. The COM35 can detect defective, manipulated firmware updates or those intended for another device and refuse installation.

The digitally signed firmware upgrades make the COM35 module future-proof and can facilitate the installation of additional security functions and updates when available.

2.9 Resetting to factory settings

The COM35 can be reset to the factory settings in two ways:

- Via the function button S1 on the COM35
- Via PROFINET

Note

By resetting to the factory settings, all communication parameters and security settings are reset. The COM35 must then be re-parameterized in the same way as for first commissioning.

2.9.1 Function button

The factory setting reset is initiated by pressing and holding the function button for 5 s.

The device signals "restricted operation" (LEDs flash green). This state remains for approx. 12 s.

If all LEDs light up orange for 1 s ("LED test"), the device restarts. The device restarts the application and signals "restricted operation" (LEDs flash green). Depending on the expansion level of the circuit breaker, this can take 10 s.

The device then switches to normal operation.

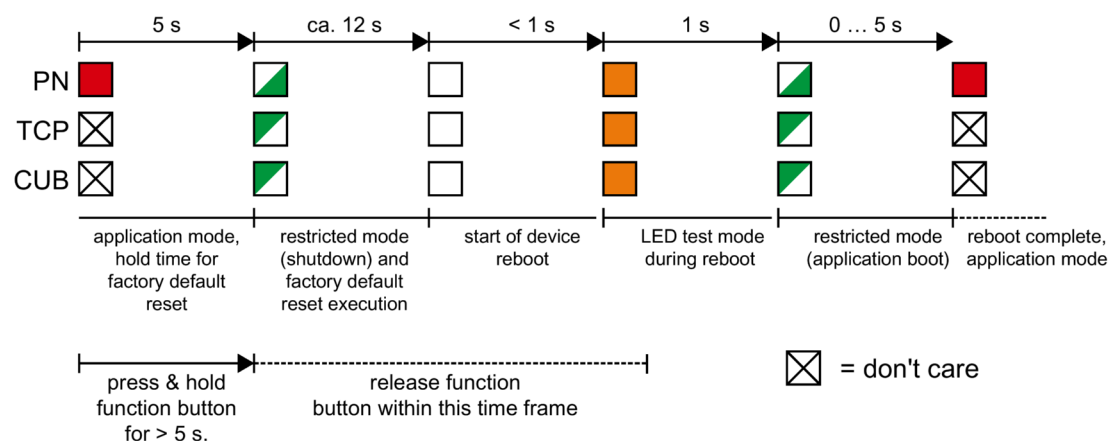
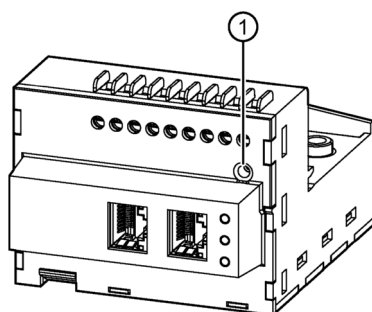

Figure 2-11 COM35 factory reset

Note

When the COM35 restarts (all LEDs light up orange for 1 s), release the function button to prevent another reset.



① Function button S1

Figure 2-12 Function button on the COM35

2.9.2 PROFINET

The standard functions of PROFINET for resetting to the factory settings are supported by COM35.

2.10 Firmware update

With the powerconfig software, firmware updates can be installed on the COM35. The firmware is digitally signed and therefore protected from manipulation or damage.

During the update process, the COM35 restarts once. If existing network connections are lost, they have to be reestablished after the COM35 has restarted. The parameters of the COM35, minimum and maximum values and the event and trip log are retained throughout the restart. The system time should be reset after the restart. You will find more information in Chapter Time synchronization (Page 40).

If the update process of the COM35 is interrupted, it continues to run without restriction with the previous firmware version. powerconfig informs the user whether the firmware update has been successful or failed. You will find further information on this in Chapter powerconfig (Page 38).

2.10.1 powerconfig

The firmware of the COM35 can be updated via the powerconfig software. The update can be accessed with the following menu items:

powerconfig menu: Device → Update → Update COM35 Firmware

You will find further information on the Internet

(<https://support.industry.siemens.com/cs/ww/en/view/63452759>).

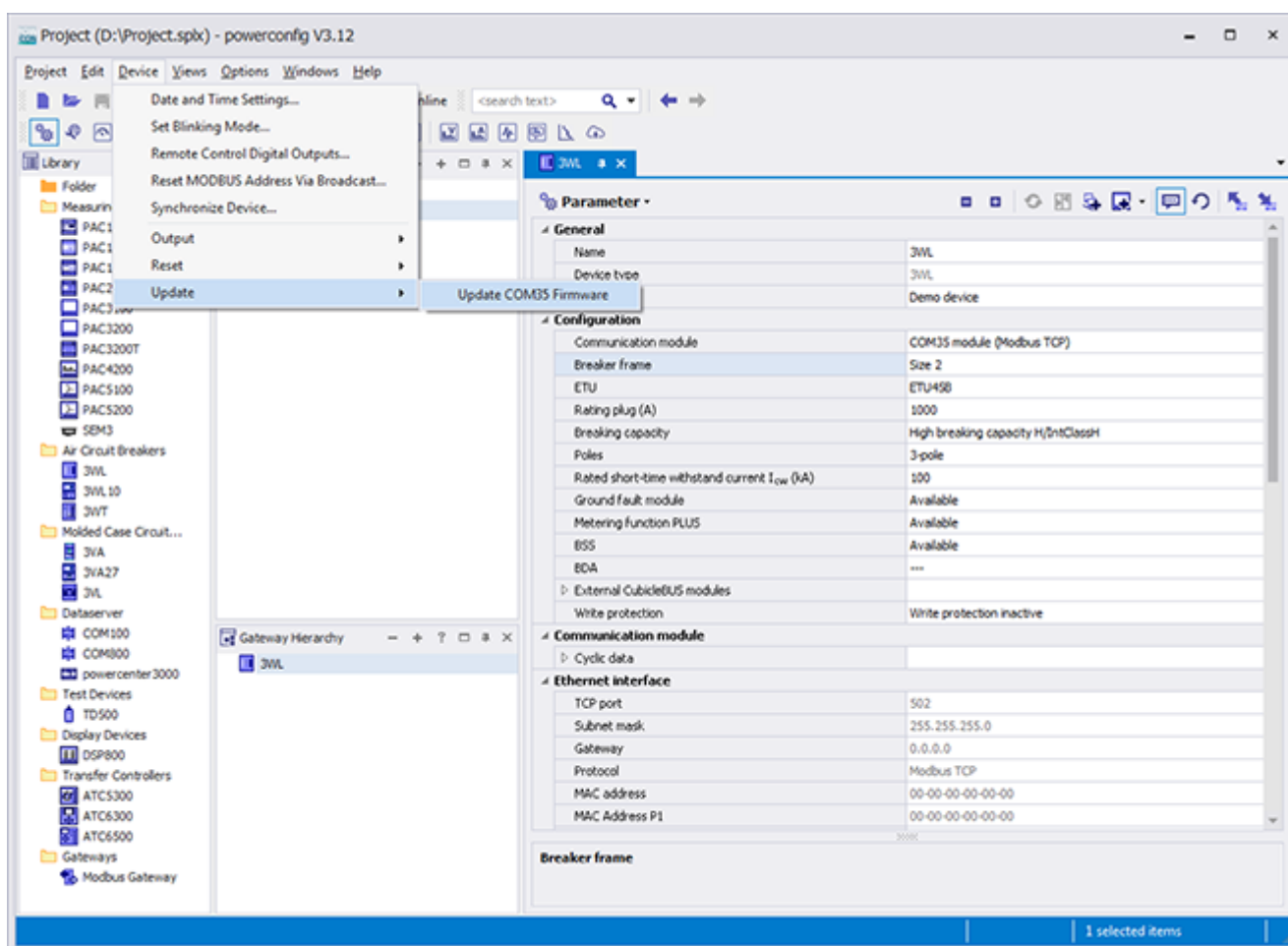

Figure 2-13 Updating the powerconfig firmware

2.10.2 Firmware files

Up-to-date firmware files can be obtained through Siemens Industry Online Support.

In the Siemens Industry Online Support, you can set "filters" for various individual focuses (e.g. topics, configurations, products) or mark specific entries as "favorites". To avoid yourself having to check whether there is news or changes to these focuses, you can get notified by the Online Support, e.g. by email (<https://support.industry.siemens.com/cs/start?lc=en-US>).

2.11 Time synchronization

The system time of the circuit breaker is generated by the COM35 and can be set on the COM35.

Note

After a restart of the COM35, the system time must be set again.

2.11.1 Parameters

The time can be set directly in the system time parameters in data set 68. You will find further information on this in Chapter Data set DS 68: CubicleBUS Output Module Status (Page 114).

2.11.2 Synchronization

The time can be synchronized in data point 18 in data sets 51 and 93. Writing value 1 into bit 5 sets the system time forward/back to the nearest half hour.

2.11.3 powerconfig

The system time of the 3WL can be set with the powerconfig software. The system time can be accessed with the following menu items:

powerconfig menu: Device → Date and Time Settings

2.11.4 System time with SNTP

The *Simple Network Time Protocol (SNTP)*, can be used to set the system time of the 3WL. SNTP is a simplified version of the NTP and automatically sets the system time with the assistance of the NTP servers (time servers).

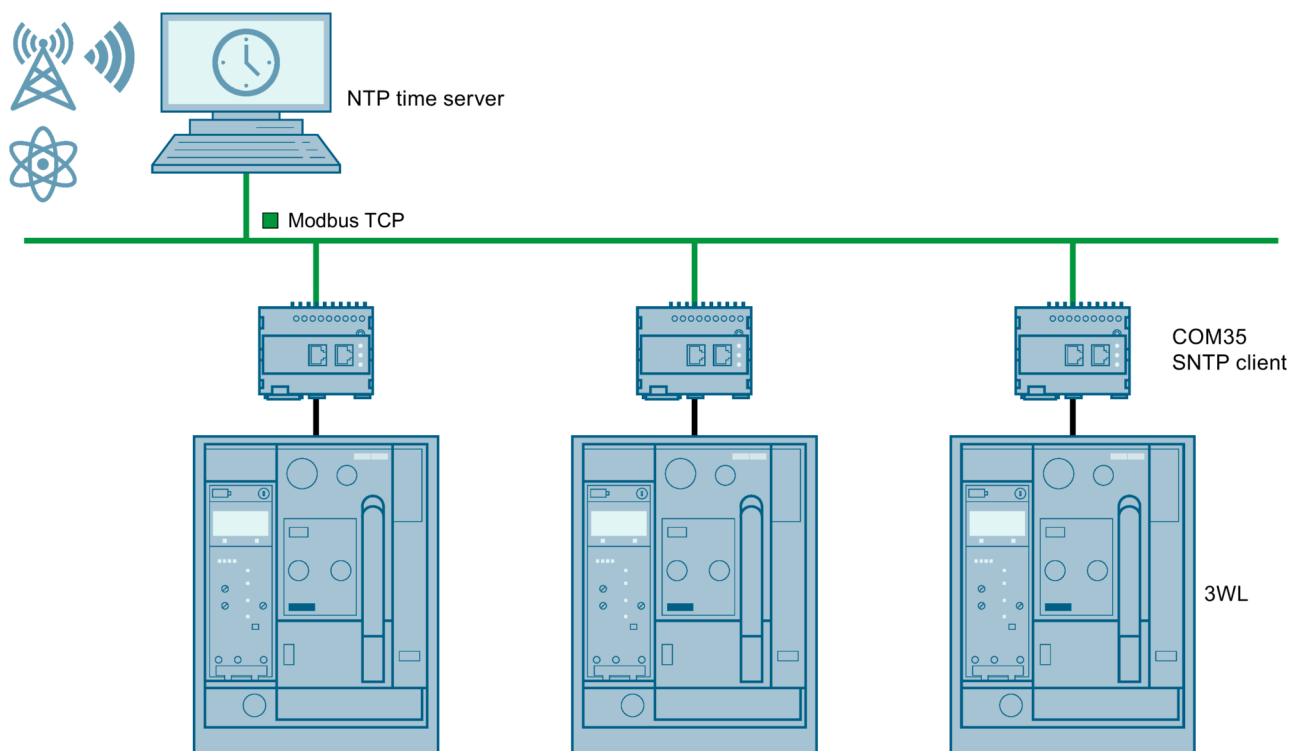

Requirements

- COM35 firmware version 1.1.0 and higher
- NTP time server
- As an option for commissioning, powerconfig software version 3.13 and higher

In order to activate the SNTP functions and write to the parameters, the COM35 write protection must be deactivated

According to the Siemens Cyber Security Disclaimer, the COM35 must not be operated in public networks. The SNTP function of the COM35 is therefore devised for a local NTP time server in closed networks.

Setting values

The Simple Network Time Protocol (SNTP) function has the following setting values for the 3WL.

- SNTP mode (OFF/Active/Passive): Setting values for the SNTP client (format 480)
- NTP server address: IPv4 address of NTP server
- SNTP port: Port address (read only)

Data points

Modbus register number*			Description	Data point	Source WL	Format	Length (bits)	Scaling
Dec	Hex	High/Low						
41226	0xA10A	–	SNTP server address	479	COM35	Unsigned long	32	–
41228	0xA10C	–	SNTP client mode	480	COM35	Format (480)	16	–
41229	0xA10D	–	SNTP port	481	COM35	Unsigned int	16	–
41292	0xA14C	LOW	Property byte: SNTP server address	(479)	COM35	PB	8	–
41292	0xA14C	HIGH	Property byte: SNTP client mode	(480)	COM35	PB	8	–
41293	0xA14D	HIGH	Property byte: SNTP port	(481)	COM35	PB	8	–

* Modbus address = Modbus register - 1

Parameters

SNTP mode (format 480)

SNTP mode Off:

- The COM35 system time is not synchronized with an NTP time server.

SNTP mode Active:

- The SNTP client sends SNTP requests once an hour to synchronize the COM35 system time. If an SNTP query is not answered, the SNTP client queries after 1 minute, after 5 minutes, and then every 15 minutes repeatedly, until the NTP server answers. If the NTP server address is zero, no synchronization requests are output and the COM35 system time is not synchronized.
- On system start, the SNTP client immediately sends an SNTP query.
- If the SNTP client configuration is changed to active mode, the client immediately sends an SNTP query.
- If the IP address of the NTP server is changed while the SNTP client is in active mode, the client immediately sends an SNTP query.

SNTP mode Passive:

- The SNTP client accepts NTP broadcasts from NTP servers and synchronizes the COM35 system time.
- If the NTP server address is zero, NTP broadcasts from any source are accepted.
- If the NTP server address is not zero, only NTP broadcasts from the configured address are accepted.

NTP server address:

- Input format hexadecimal

Example: IP v4 address as hexadecimal address

IP v4 address 192.108.219.111			
192	108	219	111
CO	A8	DB	6F
IP v4 address as hexadecimal address COA8DB6F			

2.11.5 Automatic daylight saving change

System time with daylight saving change

The 3WL has a system time that is generated in the COM35. The system time can be set via PROFINET IO or Modbus TCP and automatically synchronized via SNTP.

In order to synchronize the local system time via SNTP, the addition to or subtraction from the UTC time must be set.

As an option it is possible to set up automatic daylight saving change.

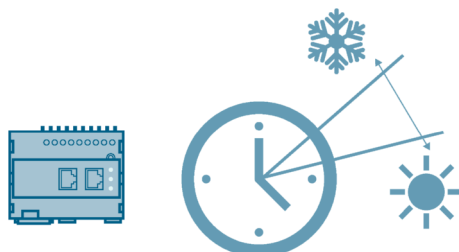

Requirements

- COM35 firmware version 1.1.0 and higher
- Optionally an NTP time server
- As an option for commissioning, powerconfig software version 3.13 and higher

The system time can be changed even if COM35 write protection is active.

System parameters can only be changed if COM35 write protection has been deactivated.

Setting values

The system time and automatic daylight saving change has the following setting values for the 3WL.

- UTC offset: Addition to or subtraction from the UTC time of the local time zone
- DST ON/OFF: Daylight saving change On/Off
- DST active: Daylight saving time active (read only)
- DST list: List of dates of automatic daylight saving change

Principle

Modbus register number*			Description	Data point	Source WL	Format	Length (bits)	Scaling
Dec	Hex	High/Low						
42755	0xA703	–	Offset from UTC	504	COM35	signed int	16	–
42756	0xA704	–	Switch daylight saving change on/off	505	COM35	unsigned int	16	–
42757	0xA705	–	If daylight saving is active	506	COM35	unsigned int	16	–
42758	0xA706	–	Date list for daylight saving change	507	COM35	Format (507)	640	–
42798	0xA72E	LOW	Property byte (offset from UTC)	504	COM35	PB	8	–
42798	0xA72E	HIGH	Property byte (switch daylight saving change on/off)	505	COM35	PB	8	–
42799	0xA72F	LOW	Property byte (if daylight saving is active)	506	COM35	PB	8	–
42799	0xA72F	HIGH	Property byte (date list for daylight saving change)	507	COM35	PB	8	–

* Modbus address = Modbus register - 1

Parameter formats

UTC offset (signed int)

- The time zone offset is a signed 16-bit integer. The unit is ½ hours. The range is between -28 (-14 h) and +24 (+12 h). The offset is relative (+/-) to UTC.

Example: Germany standard time UTC +1 h corresponds to offset UTC = +2 (2 x ½ hours)

Switch daylight saving change on/off.

- The DST function can be controlled with data point 505.
- If data point 505 is set to 1, COM35 adapts the local time based on the standard/daylight saving time defined in the daylight saving time configuration table.
- If data point 505 is set to 0, COM35 is not set to DST/standard time.

If daylight saving is active (read only)

- Data point 506 can be read to determine whether the current local time (system time) is set to daylight saving time (1) or not (0).

Date list for daylight saving change:

- COM35 supports switchover of daylight saving time via the daylight saving time configuration table.
- The table must be configured and contains the time points at which switchover from standard time to daylight saving time or vice versa is to occur.
- The table contains 2 switchover dates (start time and end time) for every year/time window and a total of 10 time windows so that up to 10 years can be configured in advance.
- The time is coded in BCD format similarly to the native 3WL time format with the exception that only the fields for year, month, day and hour are accepted.

Rules for the configuration of the DST table

1. The start and end date must be BCD-coded and represent valid dates. A null value for both dates of a line is valid. In this case, the line is ignored.
2. The DST start and end date of a line in the configuration table must have the same year.
3. The DST end date of a line must come after the DST start date of the same line.
4. The same year must not be used in several lines of the configuration table.
5. The hour of the DST start and DST end date must not be zero.
6. DST start and DST end date must not occur on the same day of the same year.
7. If a line is not to be used, it must be filled with zero.

DST table (format 507)

DST	OFFSET [byte]	Meaning
1. start DST	0	Year (BCD)
	1	Month (BCD)
	2	Day (BCD)
	3	Hour (BCD)
1. end DST	4	Year (BCD)
	5	Month (BCD)
	6	Day (BCD)
	7	Hour (BCD)
2. start DST	8 ... 11	Year / Month / Day / Hour
2. end DST	12 ... 15	Year / Month / Day / Hour
3. start DST	16 ... 19	Year / Month / Day / Hour
3. end DST	20 ... 23	Year / Month / Day / Hour
4. start DST	24 ... 27	Year / Month / Day / Hour
4. end DST	28 ... 31	Year / Month / Day / Hour
5. start DST	32 ... 35	Year / Month / Day / Hour
5. end DST	36 ... 39	Year / Month / Day / Hour
6. start DST	40 ... 43	Year / Month / Day / Hour
6. end DST	44 ... 47	Year / Month / Day / Hour
7. start DST	48 ... 51	Year / Month / Day / Hour
7. end DST	52 ... 55	Year / Month / Day / Hour
8. start DST	56 ... 59	Year / Month / Day / Hour
8. end DST	60 ... 63	Year / Month / Day / Hour
9. start DST	64 ... 67	Year / Month / Day / Hour
9. end DST	68 ... 71	Year / Month / Day / Hour
10. start DST	72 ... 75	Year / Month / Day / Hour
10. end DST	76 ... 79	Year / Month / Day / Hour

2.12 COM35 in the ETU display

The COM35 can be operated with all communication-capable 3WL circuit breakers. However, because it is not possible to update the firmware of the old ETUs, the COM35 is not recognized on the display of the ETU76B and ETU776 and is only displayed as COM. The fact that it is not recognized on the display does not restrict communication in any way.

2.13 Event and trip log

The COM35 records the last 20 system events and the last 20 trips of the circuit breaker in an event and trip log.

Both logs are FIFO memories: If a log already contains 20 entries, a new entry will overwrite the oldest entry in the log in question.

Event and trip log are permanent: They are retained even during an interruption of the auxiliary voltage of the COM35.

- The trip log can be read out via data set 53, data point 15.

You will find further information on this in Chapter Data set DS 53: Trip log (Page 112).

Note

For reasons of compatibility, the trip log is also offered in data set 51. Only the last 5 trips can be retrieved from there.

- The event log can be read out via data set 54, data point 16.

You will find further information on this in Chapter Data set DS 54: Event log (Page 113).

Note

For reasons of compatibility, the event log is also offered in data sets 51 and 92. Only the last 10 events can be retrieved from there.

2.14 Technical data

Device configuration

- 2 digital inputs
- 3 digital outputs
- 2 Ethernet interfaces for connecting to the PC or network

Energy consumption/maximum load capacity at 70 °C ambient temperature (on the module)

Table 2- 6 Energy consumption/maximum load capacity

IEC 61558 SELV/PELV – UL 1310 Class 2 power supply only		
Power supply	24 V DC	125 mA max.
Write Enable		10 mA max.
Free IN		10 mA max.
Free OUT		400 mA max. ¹⁾
Close		400 mA max.
Open		400 mA max.

1) 1 A (< 40 °C)

Supply voltage

Table 2- 7 Supply voltage

Parameters	Value
Design of the power supply	<ul style="list-style-type: none"> Power supply unit DC IEC 61558 SELV/PELV UL 1310 Class 2
Operating range	24 V DC ±20%
Power consumption	2.6 VA
Oversvoltage category	CAT I
Short-circuit protection	Yes
Protected against polarity reversal	Yes

Digital input

Table 2- 8 Digital input

Parameters	Value	
Number	2	
Type	Active	
Maximum switching voltage	24 V DC internal	
Input current	Signal "1" detection	1 ... 10 mA
	Signal "0" detection	≤ 0.2 mA
Protected against polarity reversal	Yes	

Digital output

The digital outputs are suitable for the closing/opening coils of the 3WL.

Note

The inputs and outputs of the COM35 can be damaged by voltages > 28.8 V DC (24 V + 20%). If the COM35 is to be used with open or closed solenoids with operating voltages greater than 24 V DC, interposing/coupling relays must be used.

Table 2- 9 Digital output "Close" and "Open"

Parameters		Value
Number		2
Type		Passive, normally open solid state contact
Maximum switching voltage		24 V DC \pm 20%
Output current	For signal "1"	Depends on the load and the external power supply
	Continuous load	1 A (40 °C), 400 mA (70 °C)
	Short overload due to the closing/opening coils	800 mA (70 °C), digital outputs are deactivated after 500 ms.
	For signal "0"	\leq 0.2 mA
Overvoltage category		CAT I
Short-circuit protection		No

Temperature ratings are given for ambient temperature close to the communication module.

Table 2- 10 Digital output "Free"

Parameters		Value
Number		1
Type		Passive, normally open solid state contact
Maximum switching voltage		24 V DC \pm 20%
Output current	For signal "1"	Depends on the load and the external power supply
	Continuous load	1 A (< 40 °C), 400 mA (70 °C)
	For signal "0"	\leq 0.2 mA
Overvoltage category		CAT I
Short-circuit protection		No

Temperature ratings are given for ambient temperature close to the communication module.

Communication

Table 2- 11 Ethernet interface

Parameters	Value
Ethernet	Modbus TCP, PROFINET IO
Ethernet connection	RJ45, Ethernet switch functionality
Data rate	100 Mbps
PROFINET IO connection	4
Modbus TCP connection	3

Connection elements

Table 2- 12 I/O interface connections

Parameters	Value	
Conductor cross-section	Solid	1.5 mm ²
	Stranded with ferrule, without plastic sleeve	1.0 mm ²
	Stranded with ferrule and plastic sleeve	1.0 mm ²
American Wire Gauge	18 ... 16 AWG	
Tightening torque	0.5 Nm	

Dimensions and weights

Table 2- 13 Dimensions and weights

Parameters	Value	
Enclosure dimensions W x H x D	72 mm 60 mm 92 mm	
Weight	Device without packaging	160 g
	Device including packaging	165 g

Degree of protection and safety class

Table 2- 14 Degree of protection and safety class

Parameters	Value
Protection class	Safety class II
Degree of protection according to IEC 60529	IP20

Ambient conditions

Table 2- 15 Ambient conditions

Parameters		Value
Temperature range	Ambient temperature while in operation	-40 °C ... +70 °C
	Ambient temperature during transport and storage	-40 °C ... +70 °C
Pollution degree		3

Approvals

Table 2- 16 Approvals

Parameters	Value
CE conformity to	<ul style="list-style-type: none"> • EN 60947-1 • EN 60947-2 • EN 50581
Suitable for circuit breakers with UL approval	UL489/UL1066

2.15 PROFINET IO

2.15.1 Performance features of the COM35 PROFINET module

With the COM35 communication module, you can access the data of the 3WL circuit breakers via the PROFINET IO during operation. The PROFINET IO can be run concurrently with the Modbus TCP protocol.

2.15.1.1 Overview

The COM35 communication module has the following performance features:

- Direct connection between the further Ethernet nodes by two integrated Switched Ethernet ports into the IRT domain of PROFINET
- The COM35 satisfies the highest conformance class (Conformance Class C) and the highest net load class (Net Load Class III)
- Support for ring redundancy (MRP) by the integrated Switched Ethernet ports
- The SENTRON devices communicate directly with SIMATIC S7 and SIMOTION via PROFINET IO.

This means:

The COM35 communication module as the PROFINET IO device provides metered values and states of the 3WL circuit breakers for the PROFINET IO controller. The module receives information (e.g. commands) from the PROFINET IO controller and forwards this information to the 3WL circuit breaker.

- Thanks to support for PROFINET IRT, the 3WL circuit breakers can be used without restriction directly in factory automation networks (e.g. alongside SIMATIC S7, SINUMERIK, SINAMICS and SIMOTION).
- Simple engineering with SIMATIC STEP 7 V5 or other programming systems thanks to the use of the GDSML file
- Direct integration in TIA Portal \geq V15.1
- Optimal use of the process image of a controller thanks to the selection of individual metered values
- You can use all the functions of the 3WL circuit breakers via the COM35 communication module. This permits the use of the powermanager and powerconfig software either independently of or parallel with PROFINET IO.
- The 100 Mbps data rate is supported on both RJ45 sockets.
- Time synchronization of the COM35 via SNTP
- IP settings: IP address, subnet, gateway
 - With the powerconfig parameterization software
 - Via PROFINET DCP protocol (e.g. in the STEP 7 HW Config)
- Communicates diagnostics, maintenance, and hardware interrupts
- Status display via LED

2.15.1.2 Technical data of the communication interfaces

Table 2- 17 Technical data

Description		Values
Industrial Ethernet	IRT capable switch	<ul style="list-style-type: none"> • Auto crossover • Auto negotiation
Connection		2 shielded 8-pole RJ45 sockets ¹⁾
Data transmission PROFINET IO: Supported baud rate in Mbps		100
NameOfStation ²⁾		Maximum of 240 characters
Supported communication protocols		PROFINET infrastructure protocols <ul style="list-style-type: none"> • DCP • LLDP • SNMP • DFP • MRP, MRPD
Metered values to be transferred		Cyclically definable via GSDML file or acyclically via data sets

- 1) The connector must meet the requirements of the PROFINET guideline of the PNO. You will find further information on the Internet (<https://profibus.com>).
- 2) Each device on the bus must have a unique NameOfStation and a corresponding IP configuration.

2.15.2 Parameterization/addressing

2.15.2.1 Metered values

The metered values and status information of the SENTRON 3WL circuit breaker are available to the higher-level power management system or automation system via PROFINET.

PROFINET

PROFINET provides:

- Cyclic data traffic
- Acyclic data traffic
- Acyclic alarm messages

Information on the metered values

The metered values include, for example:

- Measured values
- Extreme values of the measured values
- Energy values

The status information includes, for example:

- Open/closed state of the circuit breaker
- Springs charged status
- Ready-to-close status
- Status of the external inputs/outputs

You will find more information on the metered values in Chapter Data library (Page 93).

The metered values and status information are provided both in cyclic data traffic and acyclic data traffic.

In cyclic data traffic, the metered values and status information are provided:

- As the basic types, a predefined structure according to the PROFINET profile low-voltage switchgear (LVSG) is available.
- As individual metered values

In acyclic data traffic, the metered values and status information are provided as data sets.

Configuring via the GSDML file

In the GSDML file (<https://support.industry.siemens.com/cs/ww/en/view/109763831>), all functionalities of the COM35 both for engineering and for data exchange with the important IO Device are described.

There are basic types with predefined metered values for time-saving commissioning and efficient data transfer that are defined according to the PROFINET profile low-voltage switchgear (LVSG).

The user can also define individual metered values to be transferred.

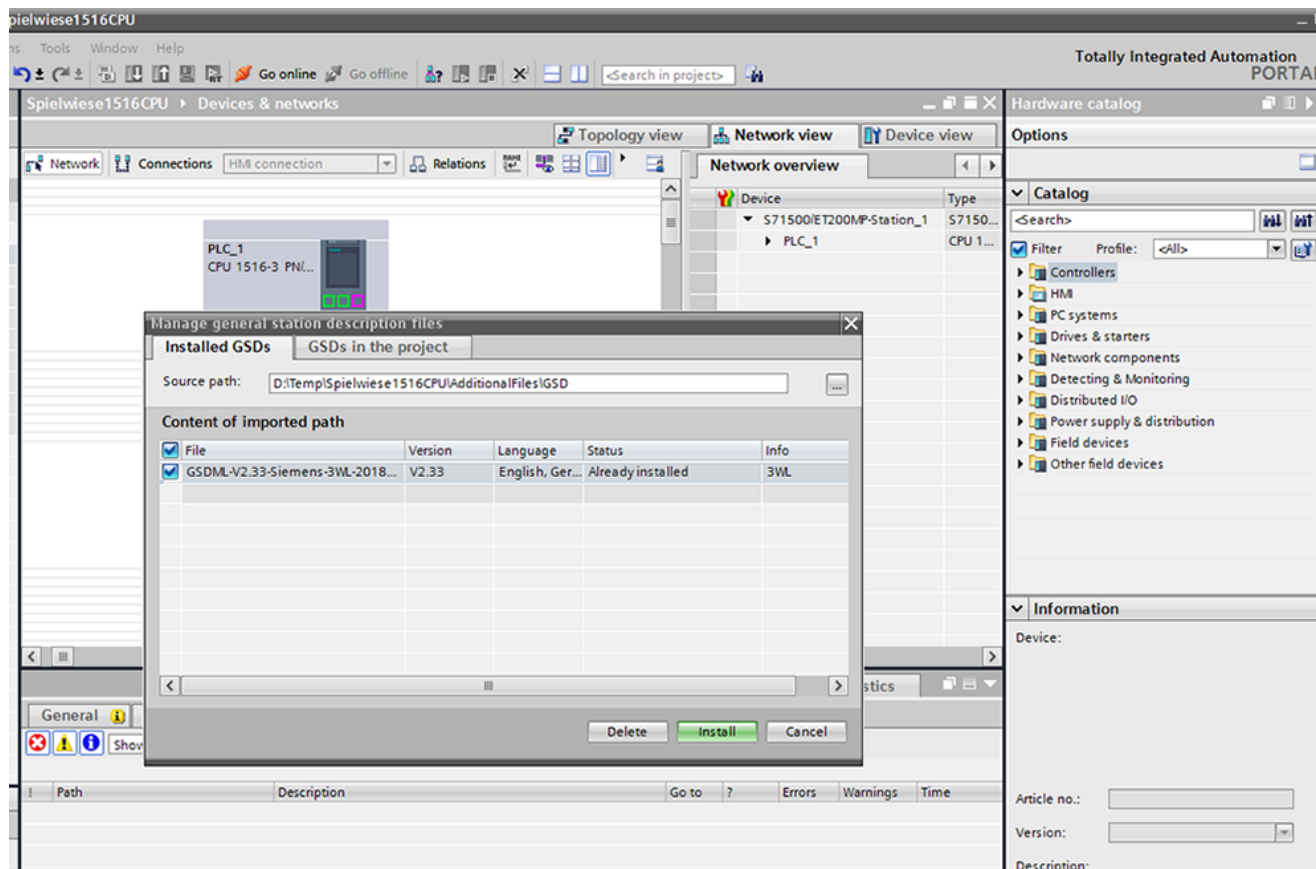

Figure 2-14 Initializing GSDML file

After GSDML integration, the 3WL circuit breaker can be found as follows:

Hardware Catalog → Catalog → Other Field Devices → PROFINET IO → Switching Devices → Siemens AG → Circuit Breaker → SENTRON

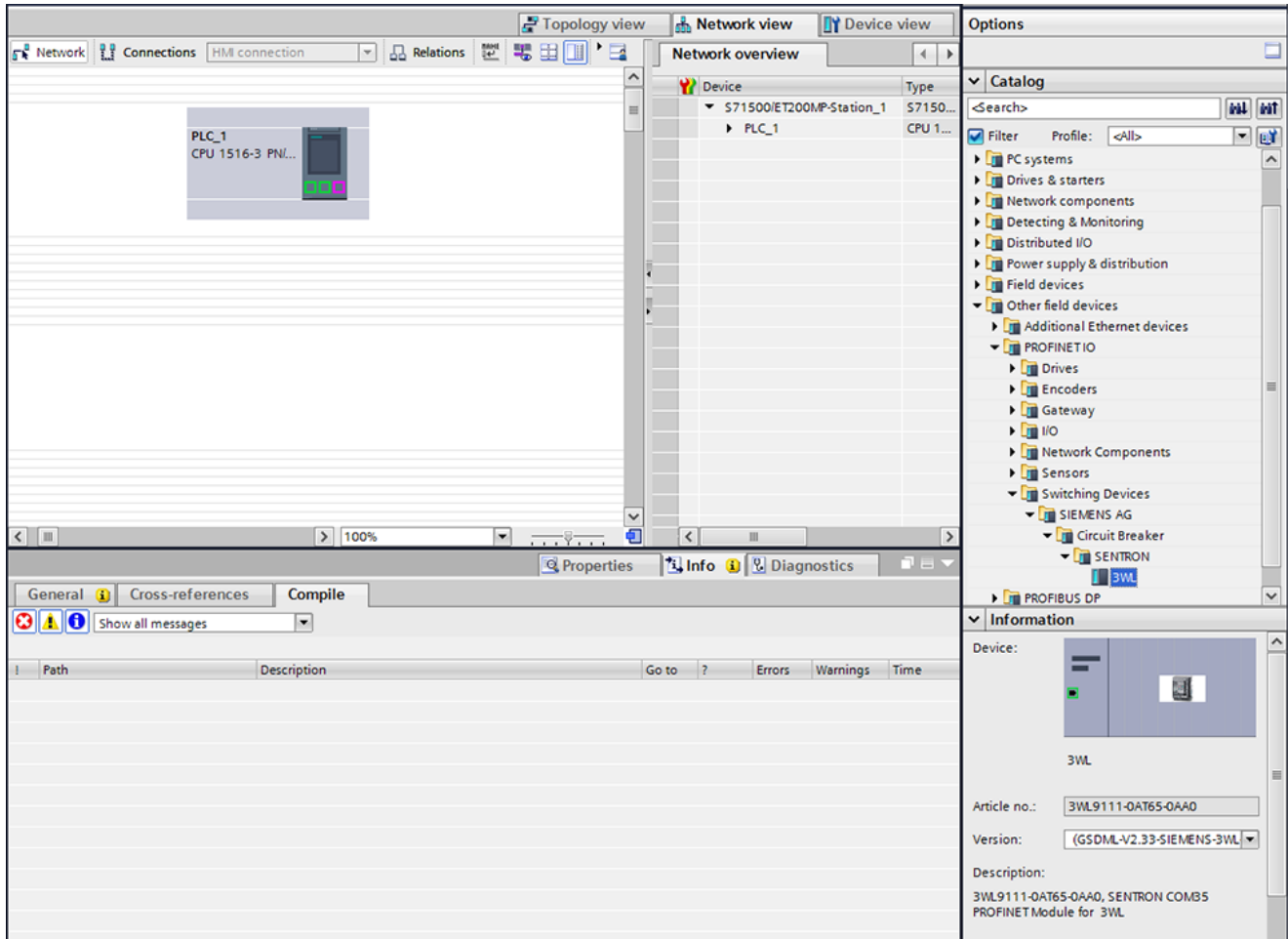

Figure 2-15 Catalog overview

2.15.2.2 Cyclic data traffic

In cyclic data traffic, each cycle transfers an optional number of user data. Cyclic data exchange is especially suitable for transferring information that is required continuously and quickly. The COM35 communication module fits into the time control of PROFINET Real-Time (RT).

- The PROFINET IO controller specifies the parameterizable update time.
- The maximum quantity structure of the cyclic data is 244 bytes of input data and 2 bytes of output data.
- The COM35 communication module supports update times of 0.5 to 512 ms.

Table 2- 18 List of all modules that can be plugged in for the project

Module name	Name	Length (bytes)	In/Out
Status and control (Fixed In Slot1)	StatusSteuerung	2	In, Out
Basic type 1	Basic_type_1	12	In
Basic type 2	Basic_type_2	24	In
Basic type 3	Basic_type_3	42	In
Temperature outside circuit breaker	MeterTempComBox	1	In
Number of open/close operations under load	DiagCountGearLoad	2	In
Number of protective trips	DiagCountGearTrip	2	In
Number of mechanical switching operations	DiagCountGearControl	2	In
Process operating hours counter	DiagHourMetering	4	In
Status digital inputs module 1	StatusInputModul1	1	In
Status digital inputs module 2	StatusInputModul2	1	In
Average power factor	MeterPowerFactorAVG	2	In
Power factor L1	MeterPowerFactorL1	2	In
Power factor L2	MeterPowerFactorL2	2	In
Power factor L3	MeterPowerFactorL3	2	In
Phase unbalance current	MeterCurrentUnbal	1	In
Phase unbalance voltage	MeterVoltageUnbal	1	In
Current L1	MeterMMCurrentL1	2	In
Current L2	MeterMMCurrentL2	2	In
Current L3	MeterMMCurrentL3	2	In
Average current of all phases	MeterMMCurrentAVGAll	2	In
Voltage L1-L2	MeterUL1L2	2	In
Voltage L2-L3	MeterUL2L3	2	In
Voltage L3-L1	MeterUL3L1	2	In
Voltage L1-N	MeterUL1N	2	In
Voltage L2-N	MeterUL2N	2	In
Voltage L3-N	MeterUL3N	2	In
Instantaneous average voltage L-L	MeterVoltageLLAVG	2	In
Instantaneous average voltage L-N	MeterVoltageLNAV	2	In

Module name	Name	Length (bytes)	In/Out
Total apparent power	MeterKVATotal	2	In
Apparent power L1	MeterKVAL1	2	In
Apparent power L2	MeterKVAL2	2	In
Apparent power L3	MeterKVAL3	2	In
Active power total	MeterKWTotal	2	In
Active power L1	MeterKWL1	2	In
Active power L2	MeterKWL2	2	In
Active power L3	MeterKWL3	2	In
Total reactive power	MeterKvarTotal	2	In
Reactive power L1	MeterKvarL1	2	In
Reactive power L2	MeterKvarL2	2	In
Reactive power L3	MeterKvarL3	2	In
Active energy import (MWh)	MeterKWHours	4	In
Active energy export (MWh)	MeterKWHoursReverse	4	In
Reactive energy import (MVARh)	MeterKvarHours	4	In
Reactive energy export (MVARh)	MeterKWHoursReverse	4	In
Frequency	MeterMMFrequency	2	In
Temperature in circuit breaker	MeterTempMSAE	1	In
Current parameter set	ControlSwitchParaSet	1	In
Current in phase with maximum load	MeterCurrentMaxAll	2	In
Current in neutral conductor	MeterCurrentNeutral	2	In
Current ground-fault	MeterCurrentGround	2	In
Time to trip	DiagTimeToTrip	2	In
Warnings in the ETU	DiagWarningTripUnit	2	In
Active energy import (kWh)	MeterActivePowerKWh	4	In
Active energy export (kWh)	MeterActivePowerReverseKWh	4	In
Reactive energy import (kVARh)	MeterReactivePowerKVARh	4	In
Reactive energy export (kVARh)	MeterReactivePowerReverseKVARh	4	In

Selection of the modules

The 3WL circuit breaker has a modular design and can be configured individually in the project.

The "status and control" module is permanently connected to the 3WL circuit breaker in slot 1, subslot 1 and is inserted automatically.

The "status and control" module contains two input bytes for the binary status information and two output bytes for control of the circuit breaker.

Both the control and the control bytes are implemented according to the LVSG profile of the PNO.

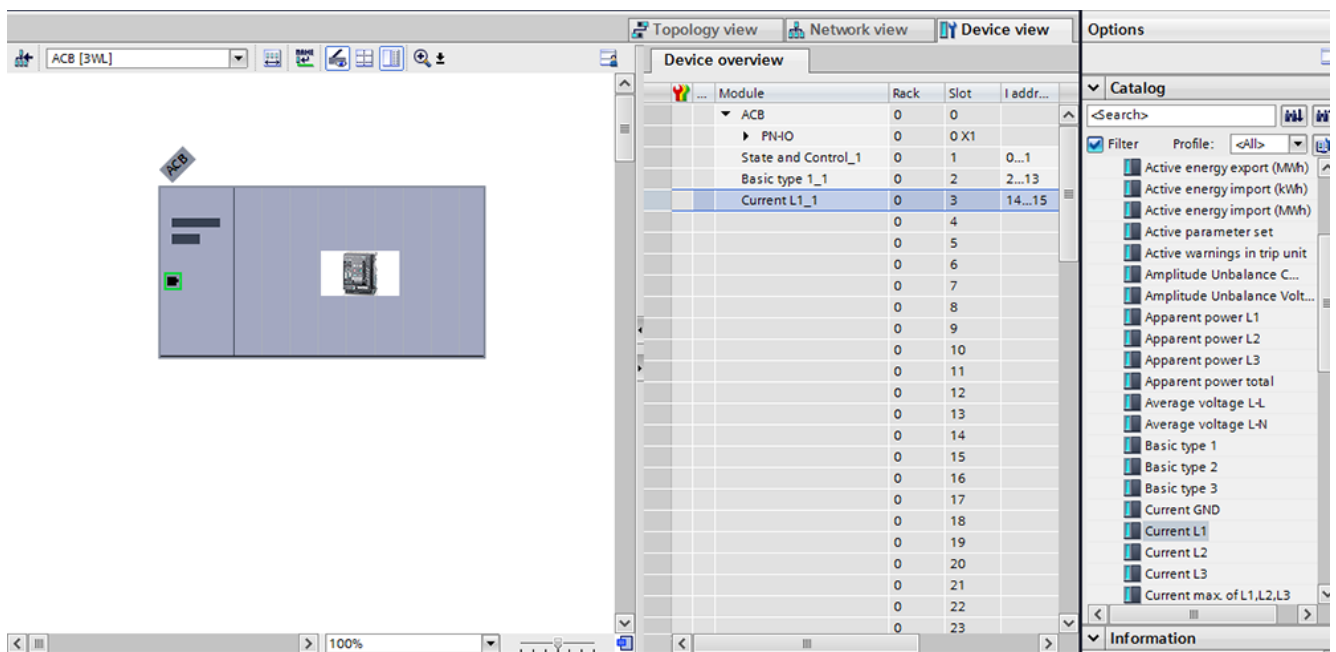

Figure 2-16 Selection of the modules

Binary status information

The table below contains a description of the binary status information in the cyclic frame:

Table 2- 19 Binary status information in the cyclic frame

Byte	Bit	Value	SENTRON WL
n	0 / 1	0 ... 3	Position of the circuit breaker in the guide frame
		0	Disconnected position
		1	Connected position
		2	Test position
		3	Circuit breaker not available
	2 / 3	0 ... 3	Status of the circuit breaker
		0	Not used
		1	Open
		2	Closed
		3	Breaker Open and Tripped
	4	–	Ready-to-close
	5	–	Undervoltage release charged
	6	–	Spring energy store is charged
	7	–	Overload alarm is pending (long-time pickup is active)
n + 1	0	–	A setpoint threshold has been exceeded
	1	–	A warning message is pending
	2	–	Write protection not active, remote changes allowed
	3	–	Status of the free user input
	4 / 5 / 6	0 ... 7	Reason for last trip
		0	No trip or last trip acknowledged
		1	Overload trip, long-time (L tripping)
		2	Instantaneous trip (I tripping)
		3	Short-time delay trip (S tripping)
		4	Ground-fault trip (G tripping)
		5	Extended protective function trip
		6	Neutral overload trip (N trip)
	7	–	
7	–	Load shed alarm	

Control bytes

The control bytes for controlling the circuit breaker are always 2 bytes long. With these control bytes, you can:

- Open/close circuit breakers
- Acknowledge messages
- Reset memory contents

Setting the outputs is edge-triggered. It is enough to set the corresponding bits for 0.5 s. Following this, these control bits must be reset to avoid subsequently triggering any undesired actions.

The table below contains a description of the control bytes for the SENTRON circuit breaker:

Table 2- 20 Control bytes for SENTRON circuit breakers

Byte	Bit	Value	SETRON WL
n	0 / 1	0 ... 3	Control the breaker open/close outputs
		0	Not defined (no action)
		1	Breaker open
		2	Breaker closed
		3	Not defined (no action)
	2	–	Acknowledge and reset currently active trip indication
	3	–	Not used
	4	–	Control of the free user output
	5	–	Not used
	6	–	Not used
n + 1	7	–	Not used
	0	–	Not used
	1	–	Not used
	2	–	Clear trip and event log
	3	–	Reset all minimum/maximum value logs (on WL, except temperature)
	4	–	Reset minimum/maximum logs for temperatures
	5	–	Not used
	6	–	Reset all maintenance information and counters which can be reset after a main contact change.
7	–	Bit for synchronizing the system time to the current half hour	

Free selection of the modules

The cyclic data can be configured in any way from the available modules. You will find further information in Table 2-18 List of all modules that can be plugged in for the project (Page 57).

Further individual modules or property bytes are provided in addition to the basic types.

Basic type 1

Basic type 1 comprises four data blocks. These are pre-assigned in such a way that they are suitable above all for use with a SENTRON WL without metering function. The most important currents of the phases are transferred.

The predefined data blocks cannot be modified.

The tables below contain lists of the data blocks of the three basic types:

Table 2- 21 Basic type 1

Byte	Definition	Default
0 / 1	Data block 1	Current in phase 1
2 / 3	Data block 2	Current in phase 2
4 / 5	Data block 3	Current in phase 3
6 / 7	Data block 4	Current in the phase under highest load
8	PB ¹⁾ of data block 1	PB of current in phase 1
9	PB of data block 2	PB of current in phase 2
10	PB of data block 3	PB of current in phase 3
11	PB of data block 4	PB of current in the phase under highest load

1) PB = Property byte

Basic type 2

Basic type 2 has eight data blocks that for a SENTRON WL are pre-assigned with metering information. Here only the average voltage values are transmitted.

The predefined data blocks cannot be modified.

Basic type 2 is pre-assigned for metering function.

Table 2- 22 Basic type 2

Byte	Definition	Default
0 / 1	Data block 1	Current in phase 1
2 / 3	Data block 2	Current in phase 2
4 / 5	Data block 3	Current in phase 3
6 / 7	Data block 4	Current in the phase under highest load
8 / 9	Data block 5	Current in neutral conductor
10 / 11	Data block 6	Average phase-to-phase voltages
12 / 13	Data block 7	Average 3-phase power factors
14 / 15	Data block 8	3-phase active energy
16	PB ¹⁾ of data block 1	PB of current in phase 1
17	PB of data block 2	PB of current in phase 2
18	PB of data block 3	PB of current in phase 3
19	PB of data block 4	PB of current in the phase under highest load
20	PB of data block 5	PB of current in neutral conductor
21	PB of data block 6	PB of the average phase-to-phase voltage
22	PB of data block 7	PB of the average power factor, 3-phase
23	PB of data block 8	PB of total active energy

1) PB = Property byte

Basic type 3

Basic type 3 has 14 data blocks that are pre-assigned measured values. These are pre-assigned in such a way that unmodified use is only meaningful with a SENTRON WL with metering function.

The predefined data blocks cannot be modified.

Table 2- 23 Basic type 3

Byte	Definition	Default
0 / 1	Data block 1	Current in phase 1
2 / 3	Data block 2	Current in phase 2
4 / 5	Data block 3	Current in phase 3
6 / 7	Data block 4	Current in the phase under highest load
8 / 9	Data block 5	Current in neutral conductor
10 / 11	Data block 6	Phase-to-phase voltage L12
12 / 13	Data block 7	Phase-to-phase voltage L23
14 / 15	Data block 8	Phase-to-phase voltage L31
16 / 17	Data block 9	Line-to-neutral voltage L1N
18 / 19	Data block 10	Line-to-neutral voltage L2N
20 / 21	Data block 11	Line-to-neutral voltage L3N
22 / 23	Data block 12	Average 3-phase power factors
24 / 25	Data block 13	3-phase active energy MWhr
26 / 27	Data block 14	3-phase apparent power kVA
28	PB ¹⁾ of data block 1	PB of current in phase 1
29	PB of data block 2	PB of current in phase 2
30	PB of data block 3	PB of current in phase 3
31	PB of data block 4	PB of current in the phase under highest load
32	PB of data block 5	PB of current in neutral conductor
33	PB of data block 6	PB of phase-to-phase voltage L12
34	PB of data block 7	PB of phase-to-phase voltage L23
35	PB of data block 8	PB of phase-to-phase voltage L31
36	PB of data block 9	PB of line-to-neutral voltage L1N
37	PB of data block 10	PB of line-to-neutral voltage L2N
38	PB of data block 11	PB of line-to-neutral voltage L3N
39	PB of data block 12	PB of the average of 3 power factors
40	PB of data block 13	PB of the total of the active energies
41	PB of data block 14	PB of the total of apparent power

¹⁾ PB = Property byte

Property byte (PB)

In each of the basic types, the assigned data blocks are followed by the associated property bytes. Each data block has its own property byte.

The property byte is information additional to the associated data block and describes the properties of the associated data point.

This property byte does not have to be evaluated but it may contain important information for the application. A property byte is also available for every data point in the data sets. If the contents of one data block or multiple data blocks of the cyclic telegram are replaced, the property byte adapts automatically.

The property byte can be used, for example, to determine whether or not a value is available. This allows the structuring of a standard interface in an HMI (operator control and monitoring system) that shows or hides the field dependent on this bit. Measured values are always "read only", but some maintenance information is "read only, but can be reset". Parameters are "read/write" or "read only" depending on the source (e.g. ETU).

All this information can be determined from the property byte. The table below contains the definitions of the property byte:

Table 2- 24 Definition of the property byte

Bit	Value	Description
0 / 1	0	Data point read/write
	1	Data point read only, but can be reset (e.g. maintenance)
	2	Data point read only, can only be written at the factory
	3	Data point read only
2	–	Bit not used
3	–	Bit not used
4	–	Data point value in valid range
5	–	Data point/option activated.
6	–	Data point/option available.
7	–	Bit not used

The table below contains examples of evaluations of the property byte:

Table 2- 25 Examples of evaluating the property byte

Value			Meaning	
Hexadecimal	Decimal	Binary		
0x70	112	0111 0000	Bit 0 / 1 = 0	Data point read/write
			Bit 4 = 1	Data point value in valid range
			Bit 5 = 1	Data point/option activated.
			Bit 6 = 1	Data point/option available
0x03	3	0000 0011	Bit 0 / 1 = 3	Data point read only
			Bit 4 = 0	Data point value not in valid range
			Bit 5 = 0	Data point/option not activated
			Bit 6 = 0	Data point/option not available

See also

Cyclic data traffic (Page 57)

2.15.3 Acyclic data traffic**Description**

In addition to cyclic data traffic, acyclic data can be transferred (e.g. parameters, diagnostics information, commands, further data). Acyclic data transfer takes place in parallel with cyclic data traffic.

You can use acyclic data traffic by the following methods:

- SIMATIC S7 CPUs contain system function blocks (SFB 52, SFB 53, SFB 54). With these, the CPUs can read and write the data sets individually and read the alarm messages.
- Any PROFINET supervisor can read and write data sets.
- Any other PROFINET controller can read and write data sets.

Note**Acyclic connections to masters**

The COM35 supports up to three Modbus TCP and up to four Supervisor connections simultaneously.

2.15.3.1 Content of the data sets**Definition of data sets**

The data sets are defined in a similar way to the COM15 (PROFIBUS module) for the 3WL circuit breaker to make the transition from PROFIBUS to PROFINET easier.

You will find a description of the data sets in Chapter Data library (Page 93).

In addition to the existing data sets, the I&M0 to I&M4 data sets for identification and maintenance of the circuit breakers/modules according to the PROFINET standard were implemented.

I&M device identification

These data sets contain the I&M information according to the PROFINET standard IEC 61158-6-10 and are used for unique identification of a 3WL circuit breaker.

Addressing the I&M data sets

Table 2- 26 Addressing the I&M data sets

Reading the I&M0 data set	Addressing the slot
For the 3WL	Slot "X1": <ul style="list-style-type: none"> • Slot number 1 • Subslot 1
For the COM35 communication module	Slot "0": <ul style="list-style-type: none"> • Slot number 0 • Subslot 1, 0x8000, 0x8001 and 0x8002

Reading all other data sets I&M1 to I&M4 is permitted across all combinations slot 0 subslot XXXX.

Writing the data sets I&M1 to I&M4 is only permitted via slot 0 subslot 1.

You can address the slot and the subslot with the slot's diagnostics address you have defined in the properties of the PROFINET device in the HW Config, for example.

Table 2- 27 Structure of data set 0xaff0 (IM0 data: read-only access)

Byte	Number of bits	Format	Standard	Description
0	16	Unsigned short	0x0020	Block type: IM0
2	16	Unsigned short	0x0038	Block length
4	8	Unsigned char	0x01	Block version High
5	8	Unsigned char	0x00	Block version Low
I&M data block 0				
0006	16	Unsigned short	42	IM0 manufacturer ID ¹⁾
0008	160	Char 20	–	IM0 part number
0028	128	Char 16	–	IM0 serial number
0044	16	Unsigned short	–	IM0 hardware version
0046	32	<ul style="list-style-type: none"> • 1*char • 3*unsigned short 	–	IM0 firmware version
0050	16	Unsigned short	0x0001	IM0 counter for changes
0052	16	Unsigned short	0x0000	IM0 profile ID
0054	16	Unsigned short	0x0005	IM0 profile-specific ID
0056	16	Unsigned short	0x0201	IM0 version of the I&M data
0058	16	Unsigned short	001E	IM0 supported I&M data
Total bytes: 60				

¹⁾ Standard: 42. "42" stands for Siemens AG.

Table 2- 28 Structure of the data set 0xaff1 (IM1 data read and write access)

Byte	Number of bits	Format	Standard	Description
0	16	Unsigned short	0x0021	Block type: IM1
2	16	Unsigned short	0x0038	Block length
4	8	Unsigned char	0x01	Block version High
5	8	Unsigned char	0x00	Block version Low
I&M data block 1				
0006	256	Char 32	20h	IM1 plant identifier
0040	176	Char 22	20h	IM1 location identifier
Total bytes: 60				

Table 2- 29 Structure of the data set 0xaff2 (IM2 data: read and write access)

Byte	Number of bits	Format	Standard	Description
0	16	Unsigned short	0x0022	Block type: IM2
2	16	Unsigned short	0x0038	Block length
4	8	Unsigned char	0x01	Block version High
5	8	Unsigned char	0x00	Block version Low
I&M data block 2				
0006	128	Char 16	YYYY-MM-DD	IM2 installation date
0022	304	Char 38	20h	Reserved
Total bytes: 60				

Table 2- 30 Structure of the data set 0xaff3 (IM3 data: read and write access)

Byte	Number of bits	Format	Standard	Description
0	16	Unsigned short	0x0023	Block type: IM3
2	16	Unsigned short	0x0038	Block length
4	8	Unsigned char	0x01	Block version High
5	8	Unsigned char	0x00	Block version Low
I&M data block 3				
0006	432	Char 54	20h	IM3 comment
Total bytes: 60				

Table 2- 31 Structure of the data set 0xaff4 (IM4 data: read and write access)

Byte	Number of bits	Format	Standard	Description
0	16	Unsigned short	0x0023	Block type: IM4
2	16	Unsigned short	0x0038	Block length
4	8	Unsigned char	0x01	Block version High
5	8	Unsigned char	0x00	Block version Low
I&M data block 2				
0006	432	Char 54	00h	IM4 signature
Total bytes: 60				

2.15.3.2 Data set error telegrams

If a data set is rejected by the COM35, the following happens:

The request is negatively acknowledged with an NRS telegram.

The request is signaled to the master with an error telegram, including negative acknowledgment and error code.

The error telegram has the following structure:

Function_Num	Error Decode	Error_Code_1	Error_Code_2
--------------	--------------	--------------	--------------

- **Function_Num**

If no error: B#16#00

For an error:

- Function identification from data set (DS) record Reading 0xDE, writing 0xDF
- DS record protocol element not used: B#16#C0

- **Error Decode**

Location of error detection: COM35 0x80

- **Error_Code_1**

Error identification (see following table)

- **Error_Code_2**

Manufacturer-specific extension of the error identification: COM35 0x00, not used.

Table 2- 32 Error_Code_1 and its cause

Code	Cause
0xA0	Read error (on read access to a "write only" DSx)
0xA1	Write error (on write access to a "read only" DSx and general error with write access)
0xA9	Function is not supported (on write access for I&M0 data)
0xB0	Invalid index (for non-implemented DSx)
0xB1	"Write"/"read" (IM data) length error (on incorrect length data for "write" DSx)
0xB2	Invalid slot (when an invalid slot is specified for "read" and "write" DSx)
0xB6	Access denied (e.g. due to write protection)
0xC2	Busy: <ul style="list-style-type: none"> For a "write" DS: The COM35 is busy with another task. It can therefore not be re-initialized. For a "read" DS: The COM35 is busy with a task in progress. Initialized data are not yet ready.
0xC4	Internal error: Data point is not found.

Note

The error telegram structure used, and the error codes are based on the SIMATIC error messages.

2.15.4 Alarm, error and system messages

The COM35 is designed as a diagnostics-capable IO Device. It detects internal and external faults and reports them to the IO controller as diagnostics, maintenance or hardware interrupts. They can be evaluated, for example, in TIA using the alarm OBs.

You obtain detailed information on the error event in case of an alarm, for example, using the SFB54 (RALRM) in the corresponding alarm OB.

The alarms of the COM35 are implemented as diagnostics, maintenance or hardware interrupts with channel information.

2.15.4.1 Structure of the diagnostic message

The following describes the basic structure of the diagnostic data sets with the individual blocks.

Diagnostic interrupt/maintenance alarm

Table 2- 33 Diagnostic interrupt/maintenance alarm

Alarm	Length
BlockType	2 bytes
BlockLength	2 bytes
BlockVersion	2 bytes
AlarmType	2 bytes
API	4 bytes
SlotNumber	2 bytes
SubslotNumber	2 bytes
ModuleIdentNumber	4 bytes
SubmoduleIdentNumber	4 bytes
AlarmSpecifier	2 bytes
UserStructureIdentifier	2 bytes
ChannelNumber	2 bytes
ChannelProperties	2 bytes
ChannelErrorTypes	2 bytes
ExtChannelErrorType	2 bytes
ExtChannelAddValue	4 bytes

Hardware interrupt

Table 2- 34 Hardware interrupt

Alarm	Length
BlockType	2 bytes
BlockLength	2 bytes
BlockVersion	2 bytes
AlarmType	2 bytes
API	4 bytes
SlotNumber	2 bytes
SubslotNumber	2 bytes
ModuleIdentNumber	4 bytes
SubmoduleIdentNumber	4 bytes
AlarmSpecifier	2 bytes
UserStructureIdentifier	2 bytes
UserData	4 bytes

"BlockType" data block

0x0002: AlarmNotification "Low" for diagnostic interrupts

0x0001: AlarmNotification "High" for hardware interrupts

"BlockLength" data block

In the "BlockLength" data field, the number of subsequent bytes of the diagnostic data set is coded. This corresponds to the length of the diagnostic data set without the number of bytes for the "BlockType" and "BlockLength" data fields, which each have a length of 2 bytes.

"BlockVersion" data block

W#16#0100: Block version of the diagnostic data set is 1.0.

"AlarmType" data block

W#16#0001: Diagnostic interrupt

W#16#0002: Hardware interrupt

"API" data block

API (Application Process Identifier): The COM35 uses the standard API "0".

"SlotNumber", "SubslotNumber" data blocks

The COM35 has the following structure as a modular PROFINET IO device:

Table 2- 35 "SlotNumber", "SubslotNumber" data blocks

Designation	SlotNumber	SubslotNumber
Head module	0	0x0001
• Interface		0x8000
• Port1		0x8001
• Port2		0x8002
Breaker	0x0001	0x0001

"ModuleIdentNumber", "SubmoduleIdentNumber" data blocks

The ModuleIdentNumber and SubmoduleIdentNumber of the module causing the alarm.

"AlarmSpecifier" data block, sequence

Table 2- 36 "AlarmSpecifier" data block, sequence

Bits	Meaning
Bit 0 ... 10	Sequence number
Bit 11	Channel diagnostics available.
Bit 12	Manufacturer-specific status information available.
Bit 13	At least one channel diagnosis available.
Bit 14	Reserved.
Bit 15	At least one of the modules configured within this AR signals a diagnosis.

"UserStructureIdentifier" data block

Table 2- 37 "UserStructureIdentifier" data block

UserStructureIdentifier	Meaning
0x0000 ... 0x7FFF	User specified
0x8000	ChannelDiagnosis
0x8002	Extended channel diagnosis

The COM35 signals all diagnostic interrupts as "Extended Channeldiagnosis". For that reason, the value of the "UserStructureIdentifier" field for the diagnostic interrupt is always "0x8002".

The hardware interrupts are signaled as "User specified" and have the value from 1 to XXX. The precise structure of the hardware interrupts is described below.

"ChannelNumber" data block

For diagnostic interrupts only

Table 2- 38 "ChannelNumber" data block

ChannelNumber	Meaning
0x0000 ... 0x7FFF	Manufacturer-specific
0x8000	Submodule

"ChannelProperties" data block

Table 2- 39 "ChannelProperties" data block

15	14	13	12	11	10	9	8	7	6	5	4	3	2	1	0
.Direction			.Specifier		.Qualifier		.Acc.	.Type							

"ChannelProperties.Type (bits 0 to 7)" data block

Table 2- 40 "ChannelProperties.Type (bits 0 to 7)" data block

Value	Meaning
0	If ChannelNumber has the value 0x8000.
1	1 bit
2	2 bits
3	4 bits
4	8 bits
5	16 bits
6	32 bits
7	64 bits

"ChannelProperties.Accumulative (bit 8)" data block

Table 2- 41 "ChannelProperties.Accumulative (bit 8)" data block

Value	Meaning
0	No channel error group signal
1	Channel error group signal (more than one channel affected)

Combination of "ChannelProperties.Qualifier (Bit 9/10)" and "ChannelProperties.Specifier (Bit 11 / 12)"

Table 2- 42 Combination of "ChannelProperties.Qualifier (Bit 9/10)" and "ChannelProperties.Specifier (Bit 11 / 12)"

Maintenance Required Bit 9	Maintenance Demanded Bit 10	Specifier bit 12 / 11	Meaning	Diagnosis in the SIMATIC S7 300 and SIMATIC S7 400 user program
0	0	00	All lower-level diagnoses are no longer pending.	Evaluation of diagnostic interrupts with SFB54 in OB82
		01	Diagnosis is pending.	Evaluation of diagnostic interrupts with SFB54 in OB82, data set reading with SFB52
		10	Diagnosis is no longer pending.	Evaluation of diagnostic interrupts with SFB54 in OB82
		11	Status message. Only possible for manufacturer-specific errors.	
	1	00	Reserved	–
		01	Maintenance requirement is pending.	Evaluation of diagnostic interrupts with SFB54 in OB82, data set reading with SFB52
		10	Maintenance requirement is no longer pending.	Evaluation of diagnostic interrupts with SFB54 in OB82
		11	Maintenance requirement is no longer pending; all others are still pending.	
1	0	00	Reserved	–
		01	Maintenance demand is pending.	Evaluation of diagnostic interrupts with SFB54 in OB82, data set reading with SFB52
		10	Maintenance demand is no longer pending.	Evaluation of diagnostic interrupts with SFB54 in OB82
		11	Maintenance demand is no longer pending; all others are still pending.	
	1	00	Reserved	–
		01	Stepped diagnosis is pending.	Evaluation of diagnostic interrupts with SFB54 in OB82, data set reading with SFB52
		10	Stepped diagnosis is no longer pending.	Evaluation of diagnostic interrupts with SFB54 in OB82
		11	Stepped diagnosis is no longer pending; all others are still pending.	

"ChannelProperties.Direction (bits 13 to 15)" data block

Table 2- 43 "ChannelProperties.Direction (bits 13 to 15)" data block

Value	Meaning
000	Manufacturer-specific
001	Input
010	Output
011	Input/Output
100 ... 111	Reserved

"ChannelErrorType" data block

In the "ChannelErrorType" field, the messages for the diagnostic interrupts and maintenance alarms are transferred.

The more precise alarm information is defined as follows in the "ChannelErrorType" and "ExtChannelErrorType" fields specifically for the COM35:

2.15.4.2 Diagnostics/maintenance alarm messages

Table 2- 44 Diagnostics/maintenance alarm

ChannelErrorType (hex)/message	ExtChannelErrorType
<p>0x100 The circuit breaker has tripped (Diag). As additional information, the trip reasons are signaled in the "ExtChannelErrorType" field.</p>	<p>1 = Long-time/overload trip 2 = Instantaneous/short-circuit trip 3 = Short-time delayed trip 4 = Ground-fault trip 5 = Enhanced protection function 6 = Overload trip in the neutral conductor 8 = Overtemperature 20 = Current unbalance 21 = Voltage unbalance 22 = Active power in normal direction 23 = Active power in reverse direction 24 = Overvoltage 25 = Undervoltage 26 = Overfrequency 27 = Underfrequency 28 = THD current 29 = THD voltage 30 = Phase sequence detection</p>
<p>0x101 Position of the circuit breaker in the guide frame changed (Diag). As the additional information, the new position of the circuit breaker is signaled in the "ExtChannelErrorType" field.</p>	<p>0 = Connected position (going) 1 = Disconnected (coming) 2 = Test position (coming) 3 = Not available (coming)</p>
<p>0x102 Maintenance of the circuit breaker necessary (maintenance). As additional information, the necessary maintenance is signaled in the "ExtChannelErrorType" field.</p>	<p>0 = No maintenance necessary (going) 1 = Perform immediate visual inspection on main contacts (coming) 2 = Prepare maintenance of the main contacts (coming)</p>

2.15.5 Hardware interrupt messages

The structure of the hardware interrupt differs from that of the diagnostic interrupt from field "UserStructIdentifier".

The hardware interrupt messages are defined as follows specifically for the COM35:

Table 2- 45 Hardware interrupt messages for the COM35

UserStructIdentifier (hex)/message	UserData (4 bytes)
0x1 CubicleBus module status	StatusCubicleBusModule: 0x00000001 = COM35 0x00000002 = Electronic trip unit ETU 0x00000004 = ZSI module 0x00000100 = Configurable digital output module 0x00000400 = Digital output module No. 2 0x00000800 = Digital input module No. 2 0x00001000 = Breaker Status Sensor (BSS) 0x00002000 = Digital output module No. 1 0x00004000 = Digital input module No. 1 0x00020000 = BDA or BDA PLUS or TD400 0x00080000 = Graphic display ETU76B / 776 0x00100000 = Analog output module No. 2 0x00200000 = Analog output module No. 1 0x00400000 = Metering function or metering function PLUS

Table 2- 46 Hardware interrupt messages for the COM35

UserStructIdentifier (hex)/message	Byte 0	Byte 1 ... 3
0x2 Changing the switching state of the circuit breaker	0x01 = OPEN 0x02 = CLOSED 0x21 = OPEN via UVR	Reserved
0x3 Ready-to-close signaling	0x01 = Ready to close 0x02 = Not ready to close	
0x5 Spring energy store of the circuit breaker	0x01 = Is not charged 0x02 = Is charged	
0x6 Changeover parameter set A/B	0x01 = Protection parameter set A active 0x02 = Protection parameter set B active	
0x7 Protection parameter has been changed.	ID of the parameter	
0x9 Write protection status changed.	0x01 = Write protection is active 0x02 = Write protection is inactive	
0xA Action is not possible when write protection is active.	Reserved	
0xB Output not remotely operated.	Reserved	

2.16 Modbus TCP

The COM35 supports the Modbus TCP protocol of the Modbus Organization, described in the following specifications:

- Modbus Application Protocol V1.1b
- Modbus Messaging Implementation Guide V1.0b

You will find further information on the Internet (<http://www.modbus.org/>).

2.16.1 Addressing

For Modbus TCP, the device is addressed via its IP address.

The device has a data point "IPv4 suite" with the format 476 (see Table 4-106 Format (476) IPv4 suite (Page 194)) that contains the communication parameters for access via TCP/IP. The data point can be found in Table 4-54 Content of data set 161 (Page 164) with byte offset 6 or at the Modbus register address 41220 (hex: 0xA104).

The standard TCP port for a Modbus TCP server is 502. The device has a data point "Modbus TCP port" that is configured as 502 in the as-delivered state. It is possible to change this value. You will find further information on this in Chapter Configurable Modbus TCP port (Page 35).

See also

Data set DS 161: Parameters for communication (Page 164)

2.16.2 Function codes

The COM35 supports the following Modbus function codes with the associated register address ranges:

Table 2- 47 Modbus function codes

Name of area	Function codes	Address area
Value buffer area	03 (0x03): Read value buffer area	0 (0x0000) ... 42336 (0xA560)
	16 (0x10): Write value buffer area	
Basic type data	04 (0x04): Read basic type data	0 (0x0000) ... 21 (0x0015) ¹⁾

¹⁾ Range depends on settings. You will find further information on this in Chapter Read basic type data (Page 81).

2.16.3 Read Holding Registers

Modbus function code 03 (hex: 0x03) reads values from the value buffer area of the COM35.

The request must contain a valid Modbus register address of a data point as the start address and must not extend beyond the end of a data set. You will find further information on this in Chapter Data sets for SENTRON WL (Page 110).

2.16.4 Write Multiple Registers

Modbus function code 16 (hex: 0x10) writes values to the value buffer area of the COM35. It is used to write complete data sets or individual data points to the COM35.

The request must contain a valid Modbus register address of a data point or start from the start address of a data set. You will find further information on this in Chapter Data sets for SENTRON WL (Page 110). Data points whose value is to be changed must be written completely.

A data point can also consist of a data structure such as, for example, data point "IPv4 suite" with format 476 (see Table 3-104 format (476) IPv4 suite in Chapter Data formats 401 to 478 (Page 191). This format must always be written in full even if only some of the values that it contains are to be modified.

2.16.5 Read basic type data

Corresponds to Modbus function code 04 (hex: 0x04) "Read Input Registers". In this way, all basic type data of a circuit breaker are read. Depending on the settings, the structure and length of the requestable data may vary.

There are three basic types available for efficient and flexible transfer. As the factory setting, the basic type 3 is selected. Depending on the application, a different basic type can be chosen. With data point 6 in data set DS 160 (see Table 4-53 Content of data set 160 (Page 163)), the currently set basic type is read out and a different basic type can be selected.

If a basic type is chosen, the list of the data points it contains can be read out via data point 7 in data set 160. Via the same data point, it is possible to adapt the basic setting of a basic type to your own requirements. You will find further information in Table 4-63 Format (7) cyclic data (Page 173)

You will find further information on the basic settings of the three basic types in Chapter Data formats of the basic types (Page 196). If a basic type is written via data point 6 in data set 160, the basic settings of this basic type are restored, and any changes are overwritten.

See also

Data set DS 160: Parameters for communication (Page 163)

Special data formats (Page 172)

3WL accessories

3.1 DSP800

The DSP800 display is used for the visualization of circuit breaker data directly at the cubicle door.

The start page of the DSP800 displays the status and maximum current of all connected circuit breakers. All the detailed information can be selected from an efficiently structured menu.

These include:

- Measured values
- Switching states
- Status
- Diagnostics

Information is visualized using predefined menus and does not require software development. Templates for 1, 2, 4 and 8 circuit breakers are available as default screens. These can either be selected and arranged automatically or they can be manually assigned. In addition, the measured values to be displayed can be selected in the overview.

The DSP800 can display up to 8 circuit breakers at the same time.

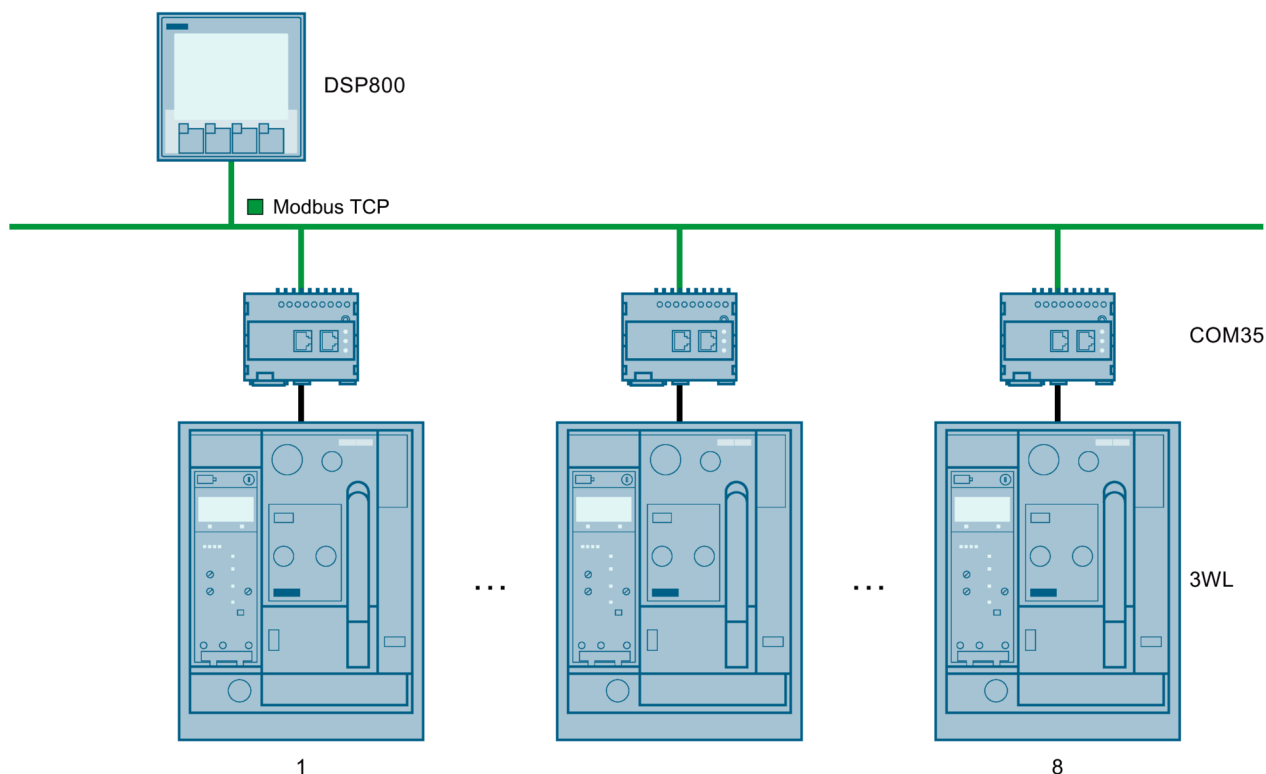

Requirements

- Communication module COM35 with air circuit breaker 3WL1, 3WL2, 3WL3, or 3WL5
- DSP800 firmware version 3.0 and higher
- As an option for commissioning, powerconfig software version 3.13 and higher
- 24 V DC supply for DSP800 and COM35

The COM35 can manage three active Modbus TCP IP connections at the same time.

Setting values

Setting values on the DSP800.

- IP address of the circuit breaker: IP addresses of the COM35

Technical data

Feature	Value
Designation	DSP800
Article number	3VA9987-0TD10 IEC 3VA9977-0TD10 UL
Protocol	Modbus TCP
Transmission medium	Ethernet, IEEE 802.3
Transmission rate	100 Mbps
Connection technology	One RJ45 socket
Circuit breakers (3WL, 3VA) total	Max. 8
Power supply	24 V DC
Door cutout	92 x 92 mm
Power consumption	2.2 W

3.2 TD400

The TD400 is a battery-operated interface converter that converts the circuit breaker interface to a standard USB and Bluetooth interface. At the same time, the ETU can be activated via the internal battery of the TD400.

The TD400 is optimized for commissioning a circuit breaker and for service. Parameters can be set, and error messages, trip information or maintenance information read out with the powerconfig software, which is available as a PC version or smartphone app.

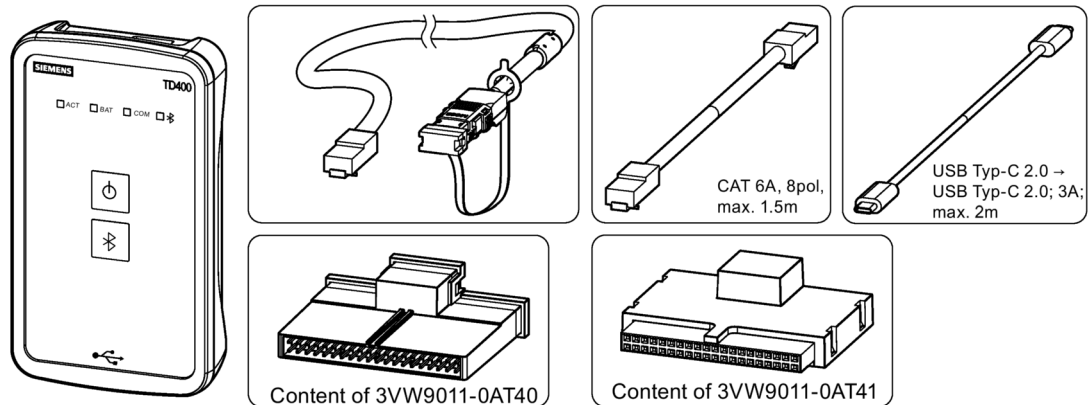

The COM35 can be commissioned with the TD400. The firmware of the COM35 communication module cannot be updated from the TD400. The TD400 can activate the ETU via the internal battery. Other CubicleBUS nodes must have been activated via the 24 V DC so that they can be visualized and set via the TD400 with the aid of the powerconfig parameterization software.

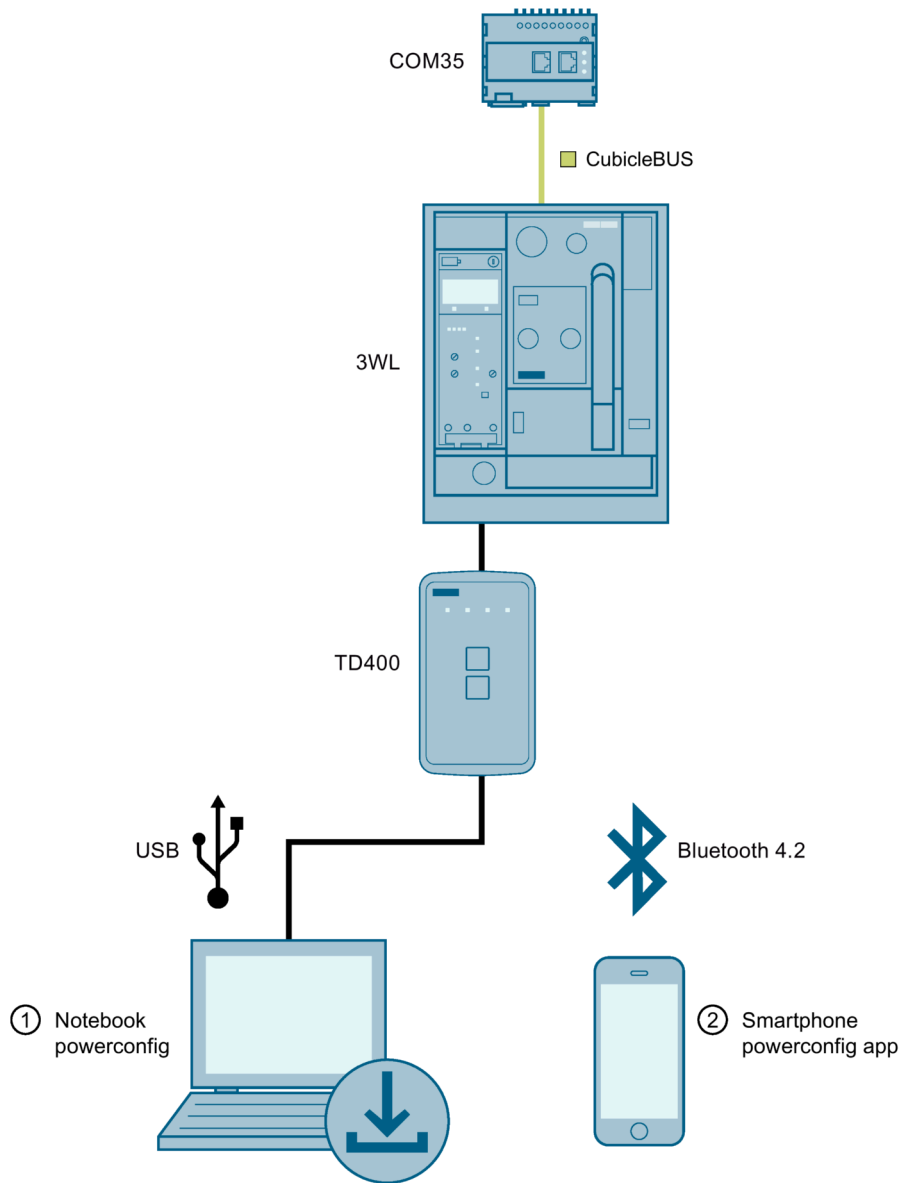

Requirements

- COM35 with air circuit breaker 3WL1, 3WL2, 3WL3, or 3WL5
- TD400 with relevant adapter for circuit breaker
- ① As an option to commissioning, powerconfig software (PC), version 3.13 and higher
- ② As an option to commissioning, SENTRON powerconfig APP software, version 2.0 and higher
- The COM35 must be powered with 24 V DC and be active

Setting values

Setting values on the TD400.

- Bluetooth PIN: The PIN is required for pairing for the first time.

Technical data

Feature	Value
Designation	TD400
Article number	3VW9011-0AT40 IEC Kit 3VW9011-0AT41 UL Kit
TD400 IEC Kit – content	TD400, case, USB cable, RJ45 cable, 3VA adapter cable, 3WL/3WT adapter for ETU Release 2
TD400 UL Kit – content	TD400, case, USB cable, RJ45 cable, 3VA adapter cable, 3WL adapter for ETU Release 1
Wireless protocol	At least Bluetooth LE version 4.2
USB protocol	USB 2.0
Connection technology	USB-C
Adapter as spare part	3WL with ETU Release 1 (3VW9011-0AT44) 3WL/3WT with ETU Release 2 (3VW9011-0AT45) 3VA2/3VA6 (3VW9011-0AT43)
Power supply	4 x AAA battery HR03
IP	IP40
Temperature operating range	-25 °C to +50 °C (temperatures below 0 °C can reduce the battery life)
Temperatures storage	-40 °C to +70 °C (without batteries)
Standards	EN 62368-1 (Communication technology – Part 1: Safety requirements) EN 61000 (electromagnetic compatibility (EMC)) EN 55014 (electromagnetic compatibility)

3.2.1 Operator controls and interfaces

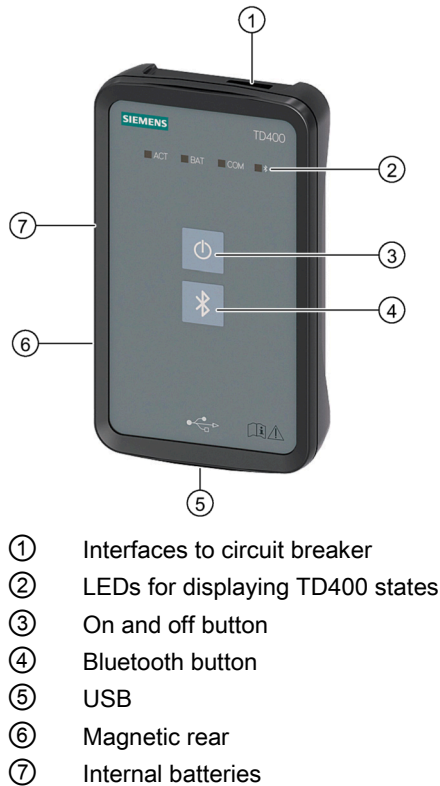

Description of operator controls and interfaces

Interfaces to circuit breaker

The cable to the circuit breaker comprises an RJ45 cable (CAT 6A, 8 pole, 1:1) and an adapter for the front interface of the ETU.

Two different adapters are available depending on the version of the ETU used. The adapters are also available individually as spare parts.

- Adapter for 3WL ETU Release 1 (3WL1 IEC prior to 2008; 3WL5 Euro UL; 3WL2 UL; 3WL3 UL ANSI). The ETU has no "Release" label.
- Adapter for 3WL ETU Release 2 (3WL1 IEC from 2008). The ETU is labeled "Release 2".
- The RJ45 interface must only be operated with the specified TD400 adapters.

Note

The RJ45 interface of the TD400 ① is not an Ethernet interface and must only be used in combination with the TD400 interface adapter.

LEDs for displaying TD400 states

- **ACT – Active:** Indicates that the TD400 is active. Flashing display indicates that the TD400 is not ready.
- **BAT – Battery:** Indicates the charge level of the internal batteries.
 - Flashing display (2 Hz) indicates that the batteries are no longer fully charged. However, the charge level is sufficient to continue activating the ETU. The activation duration can be extended with a USB power supply or power bank (see USB).
 - Flashing display (4 Hz) indicates that the charge level of the batteries is not sufficient to activate an ETU.
- **COM – Communication:** Indicates that communication with the ETU is active. Flashing means that the communication connection is being established.
- **Bluetooth:** Indicates that the Bluetooth connection to a smartphone or PC is active. Flashing means that the communication connection is being established.

On and off button

- On and off switch of the TD400, the button must be pressed for more than 0.5 seconds.
- If the TD400 is active and the button is pressed for less than 0.5 seconds, the connected ETU is activated. This is on condition that the battery is sufficiently charged.
- The active TD400 is deactivated by pressing the button (for more than 0.5 seconds).

Bluetooth button

- The Bluetooth button is used to activate and deactivate the Bluetooth function.
- The Bluetooth button calls up the pairing mode in which Bluetooth devices such as smartphones or PCs/notebooks can be connected to the TD400. The required special PIN is printed on the label of the TD400. You will find this label on the rear of the device.
- After first pairing, the PIN must be changed.
- To reset the Bluetooth connection, press the button for more than 10 seconds.

USB

- The TD400 can be connected to a PC/notebook via the USB interface (USB-C). The USB driver required for this is included in the powerconfig software.
- The USB interface can also be used to supply an activated ETU with power. For this, the ETU must be activated via the internal batteries, then the power supply can be taken up by the USB interface. The external power supply can offload the internal batteries and increase their life. For this, a USB power supply (USB-C power supply: 5 V; 3 A; 15 W) or a USB power bank (USB-C power bank: 5 V; 3 A; ≥ 10000 mAh) is needed. Suitable USB-based chargers or power banks are usually marked "Quick Charge 3.0".
- Firmware update of the TD400 via the powerconfig software (PC version)

Magnetic rear

- The TD400 has magnets at the rear for affixing it to the switchboard door or metal surfaces.

Internal batteries

- The TD400 can hold four AAA batteries. The internal batteries are needed to activate an ETU.
- The following are recommended: NiMH \leq 800 mAh HR03
- The charge level of the batteries is displayed on the BAT LED. The BAT LED displays three states:
 - Illuminated green = charge level good
 - Flashing green (2 Hz) = charge level low
 - Flashing green (4 Hz) = charge level empty

3.3 7KN POWERCENTER 3000

The 7KN Powercenter 3000 can be used in industrial, infrastructure, and building applications.

It provides simple and low-cost entry into energy management, energy distribution digitalization and cloud applications.

In this way, communication-capable 3WL circuit breakers with COM35 can be extended by several additional functions (e.g. cloud capability, overview via web interface, cross-location benchmarking, etc.).

7KN Powercenter 3000

- Offers a range of interfaces for the digitalization of low-voltage power distribution
 - One web interface for a clear overview of all connected devices
 - Data interface from the low-voltage power distribution board to MindSphere, the IoT operating system from Siemens
 - Communication interface via Modbus TCP for many applications, e.g. powermanager
- Provision of the 15 min energy values for the connected devices as a basis for energy management according to ISO 50001
- Flexible IT security features for protection against unauthorized access
- Meets the requirements of energy audits and operational energy management according to ISO 50001 and ISO 50003, based on the IEC 60364-8-1 standard

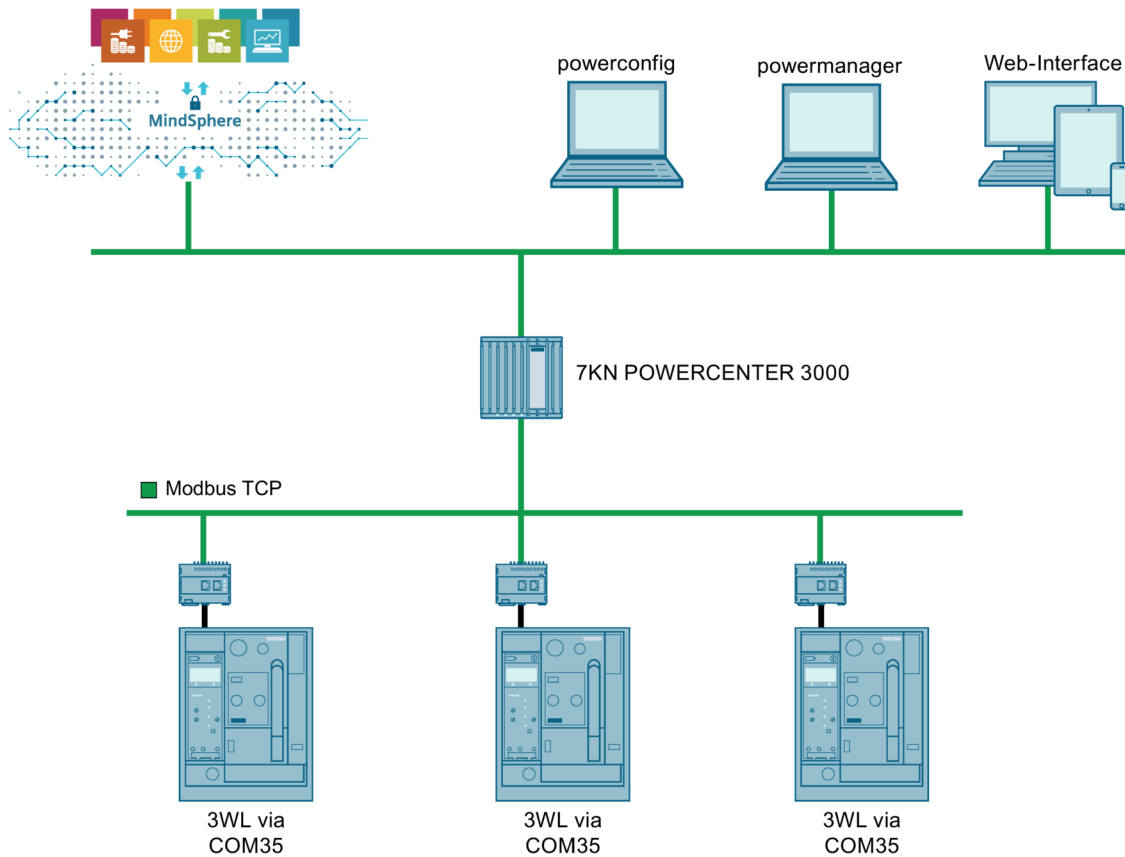

Requirements

- Communication module COM35 with air circuit breaker 3WL1, 3WL2, 3WL3, or 3WL5
- 7KN Powercenter 3000
- As an option for commissioning, powerconfig software version 3.13 and higher
- 24 V DC supply for 7KN Powercenter 3000 and COM35

The COM35 can manage three active Modbus TCP IP connections at the same time.

Setting values

Setting values on the 7KN Powercenter 3000

- IP address of the circuit breaker: IP addresses of the COM35

Technical data

Feature	Value
Designation	7KN Powercenter 3000
Article number	7KN1310-0MC00-0AA8
Protocol	Modbus TCP
Transmission medium	Ethernet, IEEE 802.3
Transmission rate	10/100/1000 Mbit/s
Connection technology	Two RJ45 sockets
Power supply	max. 1.8 A at 24 V
Installation	DIN rail

You will find more information on the 7KN Powercenter 3000 (<https://support.industry.siemens.com/cs/ww/en/view/109763838>) in Siemens Industrial Online Support.

Data library

The communication system of the SENTRON circuit breakers is extremely versatile and flexible. The majority of data points can be read, and to a certain extent written, via data sets. Basic Modbus types can be modified, basic PROFINET types cannot be modified.

This chapter provides a detailed description of the different data points and their properties.

General

The basis for the shared profile of the SENTRON circuit breakers is an overall database referred to as a data library. This data library defines which circuit breaker supports which data points.

Properties of the data points

The data library also describes the properties of all data points:

- What is the data point number of this data point and what is its name?
- What is the source of this data point?
- What is the format of this data point?
- What is the size of this data point?
- What is the scaling of this data point?
- Which register address does the data point start with?
- In which data set is this data point available?

4.1 Chapter overview

This chapter describes the data points of the data library.

First part

In the first part, the data points are combined into function classes. Function classes are, for example, data for identification, device parameters, or measured values. This subdivision quickly enables users to find the desired data point and its properties.

Second part

The second part of this chapter describes the structure of the read/write data sets that in turn consist of the data points described in the previous part. This allows the data sets transferred via Modbus TCP to be interpreted in the master.

Third part

The third part of this chapter describes the different formats of the data points. This includes the description of the format used, e.g. "int" and "unsigned int", as well as, above all, the description of special formats. A special format is, for example, the binary breakdown of the data point that specifies the last tripping operation.

4.2 Scaling

The measured values are always transferred as integer values (format "INTEGER" = "INT") and never as Floating Point numbers (format "REAL"). These values can be signed. For this, a scaling factor must be added in the case of some measured values so that the transferred measured value can be correctly interpreted. You will find the scaling factor in question in Chapter Data sets for SENTRON WL (Page 110).

Frequency example

The measured value of the current frequency (data point 262) varies between 15.00 and 440.00 Hz. The decimal places could not be communicated using the INTEGER format without scaling. For this reason, the measured value is scaled with 10^2 , and a value of between 1500 and 44000 is communicated. At the receiver end (Modbus master), this value must now be multiplied by the scaling factor corresponding to the exponent of 10 (-2 , multiplication by 10^{-2}). The exponent at the receiver end is always specified for the scaling factor.

4.3 Units

The measured values have the following measuring units unless otherwise indicated in the tables:

Table 4- 1 Units

Measured value	Measuring unit	Name
Current	A	ampere
Voltage	V	volt
Power	kW	kilowatt
Apparent power	kVA	kilovolt ampere
Reactive power	kVAR	kilovolt ampere (reactive)
Energy	kWh	kilowatt/hour
Reactive energy	kVARh	kilovolt ampere (reactive) hour
Energy	MWh	megawatt/hour
Reactive energy	MVARh	megavolt ampere (reactive) hour
Temperature	°C	degrees Celsius
THD/form factor/crest factor	%	percent
Frequency	Hz	hertz
Delay time	s	seconds

This also applies to the min./max. values.

4.4 Function classes

4.4.1 Function classes of the data points

In this section, the data points are combined into function classes. Function classes are, for example, data for identification, device parameters, or measured values. This subdivision quickly enables users to find the desired data point and its properties.

4.4.2 Data points for controlling the SENTRON circuit breakers

The SENTRON circuit breakers can be controlled with the data points listed in the table below (e.g. switch on, switch off (close/open), and also functions that control the CubicleBUS modules).

Table 4-2 Data points for controlling the circuit breaker

Description	Data point	Source WL	Format	Length (bits)	Scaling	Contained in DS.Byte
Controls the functions/commands of the communication module (e.g. reset min./ max. values)	18	COM35	Format (18)	8	–	DS51.181
Controls the outputs of the communication module (e.g. open/close the circuit breaker)	19	COM35	Format (19)	8	–	DS51.182
Date of the last parameter change	84	COM35	Time	64	–	DS91.10
System time of the circuit breaker	90	COM35	Time	64	–	DS51.194
Controls digital output module 1	121	DO1	Format (121)	8	–	DS93.8
Controls digital output module 2	126	DO2	Format (126)	8	–	DS93.9
Controls the trip unit	406	ETU	Format (406)	16	–	DS93.20
6 communication bits for the configurable digital output module	426	COM35	Format (426)	6	–	DS93.13

4.4.3 Data points for detailed diagnostics of the SENTRON circuit breakers

The SENTRON circuit breakers provide a host of data for diagnostics shown in the table below:

Table 4- 3 Data points for detailed diagnostics of the SENTRON circuit breakers

Description	Data point	Source WL	Format	Length (bits)	Scaling	Contained in DS.Byte
Write protection (Write Enable)	14	COM35	Format (14)	1	–	DS69.11
Trip log of the last 5 trips with time stamp	15	COM35	Format (15)	480	–	DS51.0
Event log of the last 10 events with time stamp	16	COM35	Format (16)	960	–	DS51.60
Trip log of the last 20 trips with time stamp	510	COM35	Format (15)	1920	–	DS53.0
Event log of the last 20 events with time stamp	16	COM35	Format (16)	960	–	DS92.42
Number of open/close operations under load	80	COM35	Unsigned int	16	0	DS91.0
Number of switching operations caused by trips	81	COM35	Unsigned int	16	0	DS91.2
Count of open/close operations	82	COM35	Unsigned int	16	0	DS91.4
Runtime meter (when closed + current > 0)	83	COM35	Unsigned long	32	0	DS91.6
Number of short-circuit trips (S & I)	104	ETU	Unsigned int	16	0	DS91.18
Number of overload trips (L)	105	ETU	Unsigned int	16	0	DS91.20
Number of ground-fault trips (G)	106	ETU	Unsigned int	16	0	DS91.22
Sum of interrupted I ² t values L1, L2, L3, N	107	ETU	Format (107)	128	0	DS91.24
Trips by metering function PLUS	307	Meter. fct. PLUS	Format (307)	16	–	DS91.28
Threshold alarms	308	Meter. fct.	Format (308)	32	–	DS92.30
Harmonics of current/voltage to the 29th harmonic	309	Meter. fct.	Format (309)	928	0	DS64.0
Part number of the trip unit	371	ETU	18 x char	144	–	DS97.126
Time until presumed overload trip	379	ETU	Unsigned int	16	0	DS51.188
Last unacknowledged tripping operation of the trip unit	401	ETU	Format (401)	8	–	DS51.1
Currently pending warnings	402	ETU	Format (402)	16	–	DS92.24
Highest current measured prior to breaker trip	403	ETU	Unsigned int	16	–	DS92.34
Phase of highest current prior to breaker trip	404	ETU	Format (393)	3	–	DS92.36
Rotary switch position of the digital input module 1	111	DI1	Format (111)	8	–	DS69.3
Rotary switch position of the digital input module 2	115	DI2	Format (111)	8	–	DS69.4

4.4 Function classes

Description	Data point	Source WL	Format	Length (bits)	Scaling	Contained in DS.Byte
Rotary switch position of the digital output module 1	119	DO1	Format (119)	8	–	DS69.5
Rotary switch position of the digital output module 2	124	DO2	Format (119)	8	–	DS69.6
Display of the phase under highest load	373	ETU	Format (373)	3	–	DS51.183
Position and status of the circuit breaker in the guide frame	24	COM35	Format (24)	4	–	DS51.202
Modules connected to the CubicleBUS	88	COM35	Format (88)	32	–	DS91.48
Status of the inputs of digital input module 1	110	DI1	Hex	8	–	DS69.0
Status of the inputs of digital input module 2	114	DI2	Hex	8	–	DS69.1
Status of outputs of the digital output module 1	118	DO1	Hex	8	–	DS68.14
Status of outputs of the digital output module 2	123	DO2	Hex	8	–	DS68.15
Status of the circuit breaker (e.g. open/closed/charged)	328	BSS	Format (328)	8	–	DS92.40
Maintenance information about the main contacts	405	ETU	Format (405)	2	–	DS91.40
IP authorization status	524	COM35	unsigned int	16	-	DS166.204

4.4.4 Data points for identifying the SENTRON circuit breakers

The SENTRON circuit breakers provide a host of data for identification shown in the table below:

Table 4- 4 Data points for identifying the SENTRON circuit breakers

Description	Data point	Source WL	Format	Length (bits)	Scaling	Contained in DS.Byte
User text (freely editable)	20	COM35	64 x char	512	–	DS165.4
Plant identifier (freely editable)	21	COM35	64 x char	512	–	DS165.68
Date (freely editable)	22	COM35	Time	64	–	DS165.132
Author (freely editable)	23	COM35	30 x char	240	–	DS165.140
ID number of the COM35	91	COM35	16 x char	128	–	DS162.4
Breaker/trip unit market (IEC/UL/ANSI)	95	ETU	Format (95)	2	–	DS97.47
ID number of circuit breaker	96	ETU	20 x char	160	–	DS97.48
Test date of the circuit breaker	98	ETU	Time	64	–	DS97.74 DS100.4
Interrupting class	99	ETU	Format (99)	4	–	DS97.82
Frame size	100	ETU	Format (100)	2	–	DS97.83
Rated voltage (LL) of the circuit breaker	101	ETU	Unsigned int	16	0	DS97.84
Rated current of the external GF CT	102	ETU	Unsigned int	16	0	DS97.86 DS129.70
Part number of circuit breaker	103	ETU	Format (103)	160	–	DS162.20 DS97.88
Number of poles of circuit breaker	108	ETU	Format (108)	3	–	DS97.144
Type (metering function, metering function PLUS)	138	Meter. fct.	Format (138)	8	–	DS162.40
Rating plug value	377	ETU	Unsigned int	16	0	DS51.208 DS97.146
Part number of the trip unit	407	ETU	16 x char	144	–	DS97.0
Date of manufacture of trip unit	408	ETU	Time	64	–	DS97.18
ID number of trip unit	409	ETU	17 x char	136	–	DS97.26
Neutral CT connected	411	ETU	Format (411)	1	–	DS97.45
Type of trip unit	412	ETU	Format (412)	5	–	DS162.41

4.4.5 Data points for measured values current

The table below contains the data points for measured values current:

Table 4- 5 Data points for measured values current

Description	Data point	Source WL	Format	Length (bits)	Scaling	Contained in DS.Byte
Phase unbalance current (%)	172	Meter. fct.	Unsigned char	8	0	DS94.0
3-phase current demand	193	Meter. fct.	Unsigned int	16	0	DS94.2
Current demand L1	194	Meter. fct.	Unsigned int	16	0	DS94.4
Current demand L2	195	Meter. fct.	Unsigned int	16	0	DS94.6
Current demand L3	196	Meter. fct.	Unsigned int	16	0	DS94.8
Minimum current demand	244	Meter. fct.	Unsigned int	16	0	DS72.24
Maximum current demand	245	Meter. fct.	Unsigned int	16	0	DS72.26
Current of phase with maximum load	374	ETU	Unsigned int	16	0	DS51.186 DS52.6
Current in neutral conductor	375	ETU	Unsigned int	16	0	DS51.190 DS94.18 DS52.8
Ground current	376	ETU	Unsigned int	16	0	DS51.192 DS94.20 DS52.10
Current in phase 1	380	ETU	Unsigned int	16	0	DS94.10
Current in phase 2	381	ETU	Unsigned int	16	0	DS94.12
Current in phase 3	382	ETU	Unsigned int	16	0	DS94.14
Average current phases 1 ... 3	383	ETU	Unsigned int	16	0	DS94.16
Minimum current in phase 1	384	ETU	Unsigned int	16	0	DS72.0
Maximum current in phase 1	385	ETU	Unsigned int	16	0	DS72.2
Minimum current in phase 2	386	ETU	Unsigned int	16	0	DS72.4
Maximum current in phase 2	387	ETU	Unsigned int	16	0	DS72.6
Minimum current in phase 3	388	ETU	Unsigned int	16	0	DS72.8
Maximum current in phase 3	389	ETU	Unsigned int	16	0	DS72.10
Maximum current in neutral conductor	390	ETU	Unsigned int	16	0	DS72.12
Maximum current in neutral conductor	391	ETU	Unsigned int	16	0	DS72.14
Minimum ground current	392	ETU	Unsigned int	16	0	DS72.16
Maximum ground current	393	ETU	Unsigned int	16	0	DS72.18
Minimum average current Phases 1 ... 3	394	ETU	Unsigned int	16	0	DS72.20
Maximum average current Phases 1 ... 3	395	ETU	Unsigned int	16	0	DS72.22

4.4.6 Data points for measured values voltage

The table below contains the data points for measured values voltage:

Table 4- 6 Data points for measured values voltage

Description	Data point	Source WL	Format	Length (bits)	Scaling	Contained in DS.Byte
Phase unbalance voltage (%)	173	Meter. fct.	Unsigned char	8	0	DS94.22
Phase-to-phase voltage L1-L2	197	Meter. fct.	Unsigned int	16	0	DS94.24
Phase-to-phase voltage L2-L3	198	Meter. fct.	Unsigned int	16	0	DS94.26
Phase-to-phase voltage L3-L1	199	Meter. fct.	Unsigned int	16	0	DS94.28
Line-to-neutral voltage phase L1	200	Meter. fct.	Unsigned int	16	0	DS94.30
Line-to-neutral voltage phase L2	201	Meter. fct.	Unsigned int	16	0	DS94.32
Line-to-neutral voltage phase L3	202	Meter. fct.	Unsigned int	16	0	DS94.34
Average phase-to-phase voltage	203	Meter. fct.	Unsigned int	16	0	DS94.36
Average line-to-neutral voltage	204	Meter. fct.	Unsigned int	16	0	DS94.38
Minimum phase-to-phase voltage L1-L2	205	Meter. fct.	Unsigned int	16	0	DS73.0
Maximum phase-to-phase voltage L1-L2	206	Meter. fct.	Unsigned int	16	0	DS73.2
Minimum phase-to-phase voltage L2-L3	207	Meter. fct.	Unsigned int	16	0	DS73.4
Maximum phase-to-phase voltage L2-L3	208	Meter. fct.	Unsigned int	16	0	DS73.6
Minimum phase-to-phase voltage L3-L1	209	Meter. fct.	Unsigned int	16	0	DS73.8
Maximum phase-to-phase voltage L3-L1	210	Meter. fct.	Unsigned int	16	0	DS73.10
Minimum line-to-neutral voltage phase L1	211	Meter. fct.	Unsigned int	16	0	DS73.12
Maximum line-to-neutral voltage phase L1	212	Meter. fct.	Unsigned int	16	0	DS73.14
Minimum line-to-neutral voltage phase L2	213	Meter. fct.	Unsigned int	16	0	DS73.16
Maximum line-to-neutral voltage phase L2	214	Meter. fct.	Unsigned int	16	0	DS73.18
Minimum line-to-neutral voltage phase L3	215	Meter. fct.	Unsigned int	16	0	DS73.20
Maximum line-to-neutral voltage phase L3	216	Meter. fct.	Unsigned int	16	0	DS73.22

4.4.7 Data points for measured values power

The table below contains the data points for measured values power.

Table 4- 7 Data points for measured values power

Description	Data point	Source WL	Format	Length (bits)	Scaling	Contained in DS.Byte
Total apparent power	217	Meter. fct.	Unsigned int	16	0	DS94.40
Apparent power in phase L1	218	Meter. fct.	Unsigned int	16	0	DS94.62
Apparent power in phase L2	219	Meter. fct.	Unsigned int	16	0	DS94.64
Apparent power in phase L3	220	Meter. fct.	Unsigned int	16	0	DS94.66
Total active power	221	Meter. fct.	Signed int	16	0	DS94.42
Active power in phase L1	222	Meter. fct.	Signed int	16	0	DS94.44
Active power in phase L2	223	Meter. fct.	Signed int	16	0	DS94.46
Active power in phase L3	224	Meter. fct.	Signed int	16	0	DS94.48
Total reactive power	225	Meter. fct.	Signed int	16	0	DS94.50
Reactive power in phase L1	226	Meter. fct.	Signed int	16	0	DS94.76
Reactive power in phase L2	227	Meter. fct.	Signed int	16	0	DS94.78
Reactive power in phase L3	228	Meter. fct.	Signed int	16	0	DS94.80
3-phase active power demand	229	Meter. fct.	Signed int	16	0	DS94.52
Active power demand in phase L1	230	Meter. fct.	Signed int	16	0	DS94.54
Active power demand in phase L2	231	Meter. fct.	Signed int	16	0	DS94.56
Active power demand in phase L3	232	Meter. fct.	Signed int	16	0	DS94.58
3-phase apparent power demand	233	Meter. fct.	Unsigned int	16	0	DS94.60
Apparent power demand in phase L1	234	Meter. fct.	Unsigned int	16	0	DS94.68
Apparent power demand in phase L2	235	Meter. fct.	Unsigned int	16	0	DS94.70
Apparent power demand in phase L3	236	Meter. fct.	Unsigned int	16	0	DS94.72
3-phase reactive power demand	237	Meter. fct.	Signed int	16	0	DS94.74
Minimum apparent power demand	246	Meter. fct.	Unsigned int	16	0	DS74.4
Maximum apparent power demand	247	Meter. fct.	Unsigned int	16	0	DS74.6
Minimum reactive power demand	248	Meter. fct.	Signed int	16	0	DS74.12
Maximum reactive power demand	249	Meter. fct.	Signed int	16	0	DS74.14
Minimum active power demand	250	Meter. fct.	Signed int	16	0	DS74.8
Maximum active power demand	251	Meter. fct.	Signed int	16	0	DS74.10

4.4.8 Data points for other measured values

The table below contains the data points for other measured values.

Table 4- 8 Data points for other measured values

Description	Data point	Source WL	Format	Length (bits)	Scaling	Contained in DS.Byte
Average power factor, 3-phase	168	Meter. fct.	Signed int	16	-3	DS51.184 DS94.98
Power factor in phase L1	169	Meter. fct.	Signed int	16	-3	DS94.100
Power factor in phase L2	170	Meter. fct.	Signed int	16	-3	DS94.102
Power factor in phase L3	171	Meter. fct.	Signed int	16	-3	DS94.104
Minimum average power factor (3-phase)	242	Meter. fct.	Signed int	16	-3	DS74.0
Maximum average power factor (3-phase)	243	Meter. fct.	Signed int	16	-3	DS74.2
Temperature in the cubicle (measured in the COM35)	71	COM35	Signed char	8	0	DS94.114
Minimum temperature in the cubicle	72	COM35	Signed char	8	0	DS77.0
Maximum temperature in the cubicle	73	COM35	Signed char	8	0	DS77.1
Temperature in circuit breaker (measured in the BSS)	330	BSS	Signed char	8	0	DS94.115
Minimum temperature in the circuit breaker	74	COM35	Signed char	8	0	DS77.2
Maximum temperature in the circuit breaker	75	COM35	Signed char	8	0	DS77.3
Active energy in normal direction [MWh]	238	Meter. fct.	Unsigned long	32	0	DS94.82
Active energy in normal direction [kWh]	433	Meter. fct.	Unsigned long	32	0	DS94.116
Active energy in reverse direction [MWh]	239	Meter. fct.	Unsigned long	32	0	DS94.86
Active energy in reverse direction [kWh]	434	Meter. fct.	Unsigned long	32	-	DS94.120
Reactive energy in normal direction [MVARh]	240	Meter. fct.	Unsigned long	32	0	DS94.90
Reactive energy in normal direction [kVARh]	435	Meter. fct.	Unsigned long	32	-	DS94.124
Reactive energy in reverse direction [MVARh]	241	Meter. fct.	Unsigned long	32	0	DS94.94
Reactive energy in reverse direction [kVARh]	436	Meter. fct.	Unsigned long	32	-	DS94.128
Frequency	262	Meter. fct.	Unsigned int	16	-2	DS94.106
Minimum frequency	252	Meter. fct.	Unsigned int	16	-2	DS76.2
Maximum frequency	253	Meter. fct.	Unsigned int	16	-2	DS76.0
THD current	254	Meter. fct.	Unsigned char	8	0	DS94.108
Minimum THD current	255	Meter. fct.	Unsigned char	8	0	DS76.4
Maximum THD current	256	Meter. fct.	Unsigned char	8	0	DS76.5

4.4 Function classes

Description	Data point	Source WL	Format	Length (bits)	Scaling	Contained in DS.Byte
THD voltage	257	Meter. fct.	Unsigned char	8	0	DS94.109
Minimum THD voltage	258	Meter. fct.	Unsigned char	8	0	DS76.6
Maximum THD voltage	259	Meter. fct.	Unsigned char	8	0	DS76.7
Crest factor	260	Meter. fct.	Unsigned char	8	-1	DS94.111
Minimum crest factor	263	Meter. fct.	Unsigned char	8	-1	DS72.28
Maximum crest factor	264	Meter. fct.	Unsigned char	8	-1	DS72.29
Form factor	261	Meter. fct.	Unsigned char	8	-1	DS94.110
Maximum form factor	266	Meter. fct.	Unsigned char	8	-1	DS72.31
Minimum form factor	265	Meter. fct.	Unsigned char	8	-1	DS72.30

4.4.9 Data points for the time stamp (TS) of the measured values

The table below contains the data points for the time stamp (TS) of the measured values.

Table 4- 9 Data points for the time stamp (TS) of the measured values

Description	Data point	Source WL	Format	Length (bits)	Scaling	Contained in DS.Byte
TS minimum current in phase L1	25	COM35	Time	64	-	DS72.32
TS maximum current in phase L1	26	COM35	Time	64	-	DS72.40
TS minimum current in phase L2	27	COM35	Time	64	-	DS72.48
TS maximum current in phase L2	28	COM35	Time	64	-	DS72.56
TS minimum current in phase L3	29	COM35	Time	64	-	DS72.64
TS maximum current in phase L3	30	COM35	Time	64	-	DS72.72
TS minimum current in neutral conductor	33	COM35	Time	64	-	DS72.112
TS maximum current in neutral conductor	34	COM35	Time	64	-	DS72.120
TS minimum ground current	35	COM35	Time	64	-	DS72.128
TS maximum ground current	36	COM35	Time	64	-	DS72.136
TS minimum average value over the three phases	31	COM35	Time	64	-	DS72.80
TS maximum average value over the three phases	32	COM35	Time	64	-	DS72.88
TS minimum current demand	55	COM35	Time	64	-	DS72.96
TS maximum current demand	56	COM35	Time	64	-	DS72.104
TS minimum phase-to-phase voltage L1-L2	37	COM35	Time	64	-	DS73.24
TS maximum phase-to-phase voltage L1-L2	38	COM35	Time	64	-	DS73.32
TS minimum phase-to-phase voltage L2-L3	39	COM35	Time	64	-	DS73.40
TS maximum phase-to-phase voltage L2-L3	40	COM35	Time	64	-	DS73.48
TS minimum phase-to-phase voltage L3-L1	41	COM35	Time	64	-	DS73.56
TS maximum phase-to-phase voltage L3-L1	42	COM35	Time	64	-	DS73.64
TS minimum line-to-neutral voltage phase L1	43	COM35	Time	64	-	DS73.72
TS maximum line-to-neutral voltage phase L1	44	COM35	Time	64	-	DS73.80
TS minimum line-to-neutral voltage phase L2	45	COM35	Time	64	-	DS73.88

Description	Data point	Source WL	Format	Length (bits)	Scaling	Contained in DS.Byte
TS maximum line-to-neutral voltage phase L2	46	COM35	Time	64	–	DS73.96
TS minimum line-to-neutral voltage phase L3	47	COM35	Time	64	–	DS73.104
TS maximum line-to-neutral voltage phase L3	48	COM35	Time	64	–	DS73.112
TS minimum average apparent power	57	COM35	Time	64	–	DS74.16
TS maximum average of apparent power	58	COM35	Time	64	–	DS74.24
TS minimum average active power	49	COM35	Time	64	–	DS74.32
TS maximum average active power	50	COM35	Time	64	–	DS74.40
TS minimum average reactive power	51	COM35	Time	64	–	DS74.48
TS maximum average reactive power	52	COM35	Time	64	–	DS74.56
TS minimum average power factor	53	COM35	Time	64	–	DS74.64
TS maximum average power factor	54	COM35	Time	64	–	DS74.72
TS minimum temperature in the cubicle	76	COM35	Time	64	–	DS77.4
TS maximum temperature in the cubicle	77	COM35	Time	64	–	DS77.12
TS minimum temperature in the circuit breaker	78	COM35	Time	64	–	DS77.20
TS maximum temperature in the circuit breaker	79	COM35	Time	64	–	DS77.28
TS minimum frequency	59	COM35	Time	64	–	DS76.8
TS maximum frequency	60	COM35	Time	64	–	DS76.16
TS minimum THD current	61	COM35	Time	64	–	DS76.24
TS maximum THD current	62	COM35	Time	64	–	DS76.32
TS minimum THD voltage	63	COM35	Time	64	–	DS76.40
TS maximum THD voltage	64	COM35	Time	64	–	DS76.48
TS minimum crest factor	65	COM35	Time	64	–	DS72.144
TS maximum crest factor	66	COM35	Time	64	–	DS72.152
TS minimum form factor	67	COM35	Time	64	–	DS72.160
TS maximum form factor	68	COM35	Time	64	–	DS72.168

4.4.10 Primary protection function parameters

The table below contains the parameters of the SENTRON circuit breakers (primary protection function).

Table 4- 10 Primary protection function parameters

Description	Data point	Source WL	Format	Length (bits)	Scaling	Contained in DS.Byte
Active parameter set	370	ETU	Format (370)	1	–	DS129.65
Overload/long-time pickup I_R PS A	333	ETU	Unsigned int	16	0	DS129.4
Overload/long-time delay t_R PS A	335	ETU	Unsigned int	16	–1	DS129.8
Instantaneous short-circuit pickup I_i PS A	336	ETU	Unsigned int	16	1	DS129.10
Short-time delayed pickup I_{sd} PS A	337	ETU	Unsigned int	16	1	DS129.12
Short-time delay t_{sd} PS A	338	ETU	Unsigned int	16	–3	DS129.14
Neutral overload pickup I_N PS A	334	ETU	Unsigned int	16	0	DS129.6
Ground-fault pickup I_g PS A	339	ETU	Unsigned int	16	0	DS129.16
Delay time for ground-fault protection t_g PS A	340	ETU	Unsigned int	16	–3	DS129.18
Ground-fault alarm pickup I_{g2} PS A	341	ETU	Unsigned int	16	0	DS129.20
Ground-fault alarm delay t_{g2} PS A	342	ETU	Unsigned int	16	–3	DS129.22
Overload/long-time delay characteristic (I^2t or I^4t) PS A	345	ETU	Format (345)	1	–	DS129.26
Short-time delay characteristic (I^2t or definite time) PS A	343	ETU	Format (343)	1	–	DS129.24
Ground-fault delay characteristic (I^2t or definite time) PS A	344	ETU	Format (344)	1	–	DS129.25
Overload/long-time thermal memory on/off PS A	346	ETU	Format (346)	1	–	DS129.27
Phase loss sensitivity PS A	347	ETU	Format (347)	1	–	DS129.28
Thermal time constant PS A	348	ETU	Unsigned int	16	0	DS129.30
Overload/long-time pickup I_R PS B	349	ETU	Unsigned int	16	0	DS129.32
Overload/long-time delay t_R PS B	351	ETU	Unsigned int	16	–1	DS129.36
Instantaneous short-circuit pickup I_i PS B	352	ETU	Unsigned int	16	1	DS129.38
Short-time delayed pickup I_{sd} PS B	353	ETU	Unsigned int	16	1	DS129.40
Delay time for short-circuit protection t_{sd} PS B	354	ETU	Unsigned int	16	–3	DS129.42
Neutral overload pickup I_N PS B	350	ETU	Unsigned int	16	0	DS129.34
Ground-fault pickup I_g PS B	355	ETU	Unsigned int	16	0	DS129.44
Ground-fault delay t_g PS B	356	ETU	Unsigned int	16	–3	DS129.46
Ground-fault alarm pickup I_{g2} PS B	357	ETU	Unsigned int	16	0	DS129.48
Ground-fault alarm delay t_{g2} PS B	358	ETU	Unsigned int	16	–3	DS129.50
Overload/long-time delay characteristic (I^2t or I^4t) PS B	361	ETU	Format (345)	1	–	DS129.54
Short-time delay characteristic (I^2t or definite time) PS B	359	ETU	Format (343)	1	–	DS129.52
Ground-fault delay characteristic (I^2t or definite time) PS B	360	ETU	Format (344)	1	–	DS129.53
Overload/long-time thermal memory on/off PS B	362	ETU	Format (346)	1	–	DS129.55

Description	Data point	Source WL	Format	Length (bits)	Scaling	Contained in DS.Byte
Phase loss sensitivity PS B	363	ETU	Format (347)	1	–	DS129.56
Thermal time constant PS B	364	ETU	Unsigned int	16	0	DS129.58
Load shed threshold	367	ETU	Unsigned int	16	0	DS129.60
Load pickup level	368	ETU	Unsigned int	16	0	DS129.62
Delay time for load shed/pickup	366	ETU	Unsigned char	8	0	DS129.64
Active parameter set	370	ETU	Format (370)	1	–	DS129.65

4.4.11 Enhanced protection function parameters

The table below contains the parameters for enhanced protection functions of the SENTRON circuit breakers. These functions will trip the circuit breaker and indicate a "trip by enhanced protection function" event.

Table 4- 11 Enhanced protection function parameters

Description	Data point	Source WL	Format	Length (bits)	Scaling	Contained in DS.Byte
Current unbalance	139	Meter. fct.	Unsigned char	8	0	DS128.41
Delay time for current unbalance	140	Meter. fct.	Unsigned char	8	0	DS128.42
Active power in normal direction	141	Meter. fct.	Unsigned int	16	0	DS128.14
Delay time for active power in normal direction	142	Meter. fct.	Unsigned char	8	0	DS128.18
Active power in reverse direction	143	Meter. fct.	Unsigned int	16	0	DS128.16
Delay time for active power in reverse direction	144	Meter. fct.	Unsigned char	8	0	DS128.19
Underfrequency	147	Meter. fct.	Unsigned int	16	0	DS128.22
Delay time for underfrequency	148	Meter. fct.	Unsigned char	8	0	DS128.25
Overfrequency	149	Meter. fct.	Unsigned int	16	0	DS128.26
Delay time for overfrequency	150	Meter. fct.	Unsigned char	8	0	DS128.24
Voltage unbalance	151	Meter. fct.	Unsigned char	8	0	DS128.32
Delay time for voltage unbalance	152	Meter. fct.	Unsigned char	8	0	DS128.33
Undervoltage	153	Meter. fct.	Unsigned int	16	0	DS128.34
Delay time for undervoltage	154	Meter. fct.	Unsigned char	8	0	DS128.38
Overvoltage	155	Meter. fct.	Unsigned int	16	0	DS128.36
Delay time for overvoltage	156	Meter. fct.	Unsigned char	8	0	DS128.39
THD current	158	Meter. fct.	Unsigned char	8	0	DS128.28
Delay time THD current	159	Meter. fct.	Unsigned char	8	0	DS128.29
THD voltage	160	Meter. fct.	Unsigned char	8	0	DS128.30
Delay time THD voltage	161	Meter. fct.	Unsigned char	8	0	DS128.31

4.4.12 Alarm setpoint parameters (threshold alarms)

The table below contains the alarm setpoint parameters of the SENTRON circuit breakers. These functions do not trip the circuit breaker but indicate a setpoint alarm event.

Table 4- 12 Alarm setpoint parameters (threshold alarms)

Description	Data point	Source WL	Format	Length (bits)	Scaling	Contained in DS.Byte
Overcurrent	267	Meter. fct.	Unsigned int	16	0	DS130.48
Delay time for overcurrent	268	Meter. fct.	Unsigned char	8	0	DS130.56
Ground current	269	Meter. fct.	Unsigned int	16	0	DS130.50
Delay time of ground current	270	Meter. fct.	Unsigned char	8	0	DS130.57
Overcurrent in neutral conductor	271	Meter. fct.	Unsigned int	16	0	DS130.52
Delay time for overcurrent in neutral conductor	272	Meter. fct.	Unsigned char	8	0	DS130.58
Phase unbalance current	273	Meter. fct.	Unsigned char	8	0	DS130.59
Delay time for current phase unbalance	274	Meter. fct.	Unsigned char	8	0	DS130.60
Current demand	275	Meter. fct.	Unsigned int	16	0	DS130.54
Delay time current demand	276	Meter. fct.	Unsigned char	8	0	DS130.61
Undervoltage	277	Meter. fct.	Unsigned int	16	0	DS130.62
Delay time for undervoltage	278	Meter. fct.	Unsigned char	8	0	DS130.64
Phase unbalance voltage	279	Meter. fct.	Unsigned char	8	0	DS130.65
Delay time for voltage phase unbalance	280	Meter. fct.	Unsigned char	8	0	DS130.66
Overvoltage	281	Meter. fct.	Unsigned int	16	0	DS130.68
Delay time for overvoltage	282	Meter. fct.	Unsigned char	8	0	DS130.70
Active power in normal direction	283	Meter. fct.	Unsigned int	16	0	DS130.4
Delay time for active power in normal direction	284	Meter. fct.	Unsigned char	8	0	DS130.12
Active power in reverse direction	285	Meter. fct.	Unsigned int	16	0	DS130.6
Delay time for active power in reverse direction	286	Meter. fct.	Unsigned char	8	0	DS130.13
Power factor, capacitive	287	Meter. fct.	Signed int	16	-3	DS130.8
Delay time for power factor, capacitive	288	Meter. fct.	Unsigned char	8	0	DS130.14
Power factor, inductive	289	Meter. fct.	Signed int	16	-3	DS130.10
Delay time for power factor, inductive	290	Meter. fct.	Unsigned char	8	0	DS130.15
Active power demand	291	Meter. fct.	Unsigned int	16	0	DS130.30
Delay time active power demand	292	Meter. fct.	Unsigned char	8	0	DS130.34
Apparent power demand	293	Meter. fct.	Unsigned int	16	0	DS130.32
Delay time apparent power demand	294	Meter. fct.	Unsigned char	8	0	DS130.35
Reactive power demand	295	Meter. fct.	Unsigned int	16	0	DS130.36
Delay time reactive power demand	296	Meter. fct.	Unsigned char	8	0	DS130.40
Reactive power in normal direction	297	Meter. fct.	Unsigned int	16	0	DS130.38
Delay time for reactive power in normal direction	298	Meter. fct.	Unsigned char	8	0	DS130.41
Reactive power in reverse direction	299	Meter. fct.	Unsigned int	16	0	DS130.42
Delay time for reactive power in reverse direction	300	Meter. fct.	Unsigned char	8	0	DS130.46
Apparent power	301	Meter. fct.	Unsigned int	16	0	DS130.44
Delay time for apparent power	302	Meter. fct.	Unsigned char	8	0	DS130.47

Description	Data point	Source WL	Format	Length (bits)	Scaling	Contained in DS.Byte
Overfrequency	303	Meter. fct.	Unsigned char	8	0	DS130.16
Delay time for overfrequency	304	Meter. fct.	Unsigned char	8	0	DS130.17
Underfrequency	305	Meter. fct.	Unsigned char	8	0	DS130.18
Delay time for underfrequency	306	Meter. fct.	Unsigned char	8	0	DS130.19
THD current	319	Meter. fct.	Unsigned char	8	0	DS130.20
Delay time for THD current	320	Meter. fct.	Unsigned char	8	0	DS130.21
THD voltage	321	Meter. fct.	Unsigned char	8	0	DS130.22
Delay time for THD voltage	322	Meter. fct.	Unsigned char	8	0	DS130.23
Crest factor	323	Meter. fct.	Unsigned int	16	-2	DS130.24
Delay time for crest factor	324	Meter. fct.	Unsigned char	8	0	DS130.28
Form factor	325	Meter. fct.	Unsigned int	16	-2	DS130.26
Delay time for the form factor	326	Meter. fct.	Unsigned char	8	0	DS130.29

4.4.13 Communication and measurement parameters

The table below contains parameters governing communication and control of the measurement functions.

Table 4- 13 Communication and measurement parameters

Description	Data point	Source WL	Format	Length (bits)	Scaling	Contained in DS.Byte
Basic type of Modbus TCP data transfer	6	COM35	Hex	2	-	DS160.6
Data in the cyclic profile of Modbus TCP	7	COM35	Format (7)	224	-	DS160.8
Configurable Digital Output Module Event Configuration	129	Conf. DO	Format (129)	168	-	DS128.46
Normal direction of incoming supply	145	Meter. fct.	Format (145)	1	-	DS128.20
Direction of phase rotation	146	Meter. fct.	Format (146)	1	-	DS128.21
Primary VT connection – star (delta) or wye	162	Meter. fct.	Format (162)	1	-	DS128.4
Rated phase-to-phase primary voltage	164	Meter. fct.	Unsigned int	16	0	DS128.6
Secondary VT rating	165	Meter. fct.	Unsigned char	8	0	DS128.8
Period length for demand calculations	166	Meter. fct.	Unsigned char	8	0	DS128.9
Number of sub-periods for demand calculations	167	Meter. fct.	Unsigned char	8	0	DS128.10
Current underflow (values less than this are communicated as 0)	372	ETU	Unsigned int	16	0	DS128.12
Ground-fault sensing method	410	ETU	Format (410)	2	-	DS97.44 DS129.69

4.5 Data sets for SENTRON WL

4.5.1 Difference between Modbus register number and register address

According to the Modbus Application Protocol Specification V1.1b 6.3, the Modbus register number and register address are different.

In order to obtain the register address, the register number must be reduced by the value 1.

Register address = register number - 1

Example DP 15: Register address data point 15 = Modbus register number 0x3301 – 1 = 0x3300

4.5.2 Data set DS 51: Main overview

The table below shows the content of data set 51 that copies the most important information from other data sets and makes it available in the form of a complete overview. This data set is used to display the data of the main overview (length 119 Modbus registers, read only).

Table 4- 14 Content of data set 51

Byte offset	Modbus register number			Description	Data point	Source WL	Format	Length (bits)	Scaling
	Dec	Hex	High/Low						
0	13057	0x3301	–	Trip log of the last 5 trips with time stamp	15	COM35	Format (15)	480	–
60	13087	0x331F	–	Event log of the last 10 events with time stamp	16	COM35	Format (16)	960	–
180	13147	0x335B	LOW	Reserved	–	–	–	8	–
181	13147	0x335B	HIGH	Controls the commands/functions of the communication module (e.g. clear or reset min./max. values)	18	COM35	Format (18)	8	–
182	13148	0x335C	LOW	Reserved	–	–	–	8	–
183	13148	0x335C	HIGH	Shows the phase with maximum load	373	ETU	Format (373)	3	–
184	13149	0x335D	–	Average power factor, 3-phase	168	Meter. fct.	Signed int	16	–3
186	13150	0x335E	–	Current in phase with maximum load	374	ETU	Unsigned int	16	0
188	13151	0x335F	–	Time until presumed overload trip	379	ETU	Unsigned int	16	0
190	13152	0x3360	–	Current in neutral conductor	375	ETU	Unsigned int	16	0
192	13153	0x3361	–	Ground current	376	ETU	Unsigned int	16	0

Byte offset	Modbus register number			Description	Data point	Source WL	Format	Length (bits)	Scaling
	Dec	Hex	High/Low						
194	13154	0x3362	–	System time of the circuit breaker	90	COM35	Time	64	–
202	13158	0x3366	LOW	Position of the circuit breaker in the frame	24	COM35	Format (24)	4	–
203	13158	0x3366	HIGH	Status of the circuit breaker (e.g. open/closed/charged)	328	BSS	Format (328)	8	–
204	13159	0x3367	–	Overload/long-time pickup I _R PS A	333	ETU	Unsigned int	16	0
206	13160	0x3368	–	Overload/long-time pickup I _R PS B	349	ETU	Unsigned int	16	0
208	13161	0x3369	–	Rating plug value	377	ETU	Unsigned int	16	0
210	13162	0x336A	LOW	Active parameter set	370	ETU	Format (370)	1	–
211	13162	0x336A	–	Reserved	–	–	–	72	–
220	13167	0x336F	LOW	Property byte: Trip log of the last 5 trips with time stamp	–	COM35	PB	8	–
221	13167	0x336F	HIGH	Property byte: Event log of the last 10 events with time stamp	–	COM35	PB	8	–
222	13168	0x3370	LOW	Reserved	–	–	–	8	–
223	13168	0x3370	HIGH	Property byte of the communication module: Controls the commands/functions (e.g. clear or reset min./max. values)	–	COM35	PB	8	–
224	13169	0x3371	LOW	Reserved	–	–	–	8	–
225	13169	0x3371	HIGH	Property byte for byte 183: Shows the phase with maximum load	–	ETU	PB	8	–
226	13170	0x3372	LOW	Property byte: Average power factor, 3-phase	–	Meter. fct.	PB	8	–
227	13170	0x3372	HIGH	Property byte: Current in phase with maximum load	–	ETU	PB	8	–
228	13171	0x3373	LOW	Property byte for byte 188: Time until presumed overload trip	–	ETU	PB	8	–
229	13171	0x3373	HIGH	Property byte: Current in neutral conductor	–	ETU	PB	8	–
230	13172	0x3374	LOW	Property byte: Ground current	–	ETU	PB	8	–

4.5 Data sets for SENTRON WL

Byte offset	Modbus register number			Description	Data point	Source WL	Format	Length (bits)	Scaling
	Dec	Hex	High/Low						
231	13172	0x3374	HIGH	Property byte: System time of the circuit breaker	–	COM35	PB	8	–
232	13173	0x3375	LOW	Property byte: Position of the circuit breaker in the frame	–	COM35	PB	8	–
233	13173	0x3375	HIGH	Property byte: Status of the circuit breaker (e.g. open/closed/charged)	–	BSS	PB	8	–
234	13174	0x3376	LOW	Property byte: Overload/long-time pickup I _R PS A	–	ETU	PB	8	–
235	13174	0x3376	HIGH	Property byte: Overload/long-time pickup I _R PS B	–	ETU	PB	8	–
236	13175	0x3377	LOW	Property byte: Rating plug value	–	ETU	PB	8	–
237	13175	0x3377	HIGH	Property byte: Active parameter set	–	ETU	PB	8	–

4.5.3 Data set DS 53: Trip log

The table below shows the content of data set 53, main overview (length 121 Modbus registers, read only) that copies the most important information from other data sets and makes it available in the form of a complete overview. This data set is used to display the trip log.

Table 4- 15 Content of data set 53

Byte offset	Modbus register number			Description	Data point	Source WL	Format	Length (bits)	Scaling
	Dec	Hex	High/Low						
0	13569	0x3501	–	Trip log of the last 20 trips with time stamp	15	COM35	Format (15)	1920	–
240	13689	0x3579	LOW	Property byte: Trip log of the last 20 trips with time stamp	–	COM35	PB	8	–

4.5.4 Data set DS 54: Event log

The table below shows the content of data set 54, main overview (length 121 Modbus registers, read only) that copies the most important information from other data sets and makes it available in the form of a complete overview. This data set is used to display the event log.

Table 4- 16 Content of data set 54

Byte offset	Modbus register number			Description	Data point	Source WL	Format	Length (bits)	Scaling
	Dec	Hex	High/Low						
0	13825	0x3601	–	Event log of the last 20 events with time stamp	16	COM35	Format (15)	1920	–
240	13945	0x3679	LOW	Property byte: Event log of the last 20 events with time stamp	–	COM35	PB	8	–

4.5.5 Data set DS 64: Data of the harmonics analysis

The table below shows the content of data set 64, data of the harmonic analysis (length 66 Modbus registers, read only) in which the components of the harmonics of current and voltage are transmitted. The content is described in the format (309). The property byte provides information as to whether the data point is available. Generally, a harmonic analysis is only available with a SENTRON WL with metering function PLUS.

Table 4- 17 Content of data set 64

Byte offset	Modbus register number			Description	Data point	Source WL	Format	Length (bits)	Scaling
	Dec	Hex	High/Low						
0	16385	0x4001	–	Harmonics of current/voltage to the 29th harmonic	309	Meter. fct.	Format (309)	928	0
116	16443	0x403B	–	Reserved	–	–	–	112	–
130	16450	0x4042	LOW	Property byte: Harmonics of current/voltage to the 29th harmonic	309	Meter. fct.	PB	8	–

4.5.6 Data set DS 68: CubicleBUS Output Module Status

The table below shows the content of data set 68, data of the CubicleBUS modules (length 23 Modbus registers, read and write) with which you can do the following:

- Read and control outputs of the digital output modules
- Read out and set the system time
- Set outputs of the communication module (close/open circuit breaker)

Table 4- 18 Content of data set 68

Byte offset	Modbus register number			Description	Data point	Source WL	Format	Length (bits)	Scaling
	Dec	Hex	High/Low						
0	17409	0x4401	–	Header; value 0x00 00 00 00	–	COM35	–	32	–
4	17411	0x4403	–	System time of the circuit breaker	90	COM35	Time	64	–
12	17415	0x4407	–	Reserved	–	–	–	16	–
14	17416	0x4408	LOW	Status of outputs of the digital output module 1	118	DO1	Hex	8	–
15	17416	0x4408	HIGH	Status of outputs of the digital output module 2	123	DO2	Hex	8	–
16	17417	0x4409	–	Reserved	–	–	–	192	–
40	17429	0x4415	LOW	Property byte: System time of the circuit breaker	–	COM35	PB	8	–
41	17429	0x4415	HIGH	Reserved	–	COM35	–	8	–
42	17430	0x4416	LOW	Reserved	–	–	–	8	–
43	17430	0x4416	HIGH	Property byte: Status of outputs of the digital output module 1	–	DO1	PB	8	–
44	17431	0x4417	LOW	Property byte: Status of outputs of the digital output module 2	–	DO2	PB	8	–

4.5.7 Data set DS 69: CubicleBUS Input Module Status

The table below shows the content of data set 69, status of the modules (length 22 Modbus registers, read only) in which the statuses of the inputs on the digital input modules and the input on the COM35 module are transmitted. It also contains the circuit breaker positions on the digital input modules and output modules on the CubicleBUS.

Table 4- 19 Content of data set 69

Byte offset	Modbus register number			Description	Data point	Source WL	Format	Length (bits)	Scaling
	Dec	Hex	High/Low						
0	17665	0x4501	LOW	Status of the inputs of digital input module 1	110	DI1	Hex	8	–
1	17665	0x4501	HIGH	Status of the inputs of digital input module 2	114	DI2	Hex	8	–
2	17666	0x4502	LOW	Reserved	–	–	–	8	–
3	17666	0x4502	HIGH	Rotary switch position of the digital input module 1	111	DI1	Format (111)	8	–
4	17667	0x4503	LOW	Rotary switch position of the digital input module 2	115	DI2	Format (111)	8	–
5	17667	0x4503	HIGH	Rotary switch position of the digital output module 1	119	DO1	Format (119)	8	–
6	17668	0x4504	LOW	Rotary switch position of the digital output module 2	124	DO2	Format (119)	8	–
7	17668	0x4504	–	Reserved	–	–	–	32	–
11	17670	0x4506	HIGH	Communication module write protection (Write Enable)	14	COM35	Format (14)	1	–
12	17671	0x4507	LOW	Reserved	–	–	–	8	–
13	17671	0x4507	HIGH	6 Modbus communication module bits for the configurable digital output module	426	COM35	Format (426)	6	–
14	17672	0x4508	–	Reserved	–	–	–	120	–
29	17679	0x450F	HIGH	Property byte: 6 Modbus communication module bits for the configurable digital output module	–	COM35	PB	8	–
30	17680	0x4510	LOW	Property byte: Status of the inputs of digital input module 1	–	DI1	PB	8	–
31	17680	0x4510	HIGH	Property byte: Status of the inputs of digital input module 2	–	DI2	PB	8	–
32	17681	0x4511	LOW	Reserved	–	–	–	8	–

4.5 Data sets for SENTRON WL

Byte offset	Modbus register number			Description	Data point	Source WL	Format	Length (bits)	Scaling
	Dec	Hex	High/Low						
33	17681	0x4511	HIGH	Property byte: Circuit breaker position at the digital input module 1	–	DI1	PB	8	–
34	17682	0x4512	LOW	Property byte: Circuit breaker position at the digital input module 2	–	DI2	PB	8	–
35	17682	0x4512	HIGH	Property byte: Circuit breaker position at the digital output module 1	–	DO1	PB	8	–
36	17683	0x4513	LOW	Property byte: Circuit breaker position at the digital output module 2	–	DO2	PB	8	–
37	17683	0x4513	–	Reserved	–	–	–	32	–
41	17685	0x4515	HIGH	Property byte: Communication module write protection (Write Enable)	–	COM35	PB	8	–
42	17686	0x4516	LOW	Reserved	–	–	–	8	–

4.5.8 Data set DS 72: Min./max. measured metered value log

The table below shows the content of data set 72 (length 118 Modbus registers, read only) in which the minimum and maximum measured values of the currents are transmitted. It also contains the associated time stamps for these minimum and maximum measured values.

Table 4- 20 Content of data set 72

Byte offset	Modbus register number			Description	Data point	Source WL	Format	Length (bits)	Scaling
	Dec	Hex	High/Low						
0	18433	0x4801	–	Minimum current in phase 1	384	ETU	Unsigned int	16	0
2	18434	0x4802	–	Maximum current in phase 1	385	ETU	Unsigned int	16	0
4	18435	0x4803	–	Minimum current in phase 2	386	ETU	Unsigned int	16	0
6	18436	0x4804	–	Maximum current in phase 2	387	ETU	Unsigned int	16	0
8	18437	0x4805	–	Minimum current in phase 3	388	ETU	Unsigned int	16	0
10	18438	0x4806	–	Maximum current in phase 3	389	ETU	Unsigned int	16	0
12	18439	0x4807	–	Maximum current in neutral conductor	390	ETU	Unsigned int	16	0

Byte offset	Modbus register number			Description	Data point	Source WL	Format	Length (bits)	Scaling
	Dec	Hex	High/Low						
14	18440	0x4808	–	Maximum current in neutral conductor	391	ETU	Unsigned int	16	0
16	18441	0x4809	–	Minimum ground current	392	ETU	Unsigned int	16	0
18	18442	0x480A	–	Maximum ground current	393	ETU	Unsigned int	16	0
20	18443	0x480B	–	Minimum average 3-phase current	394	ETU	Unsigned int	16	0
22	18444	0x480C	–	Maximum average 3-phase current	395	ETU	Unsigned int	16	0
24	18445	0x480D	–	Minimum current demand	244	Meter. fct.	Unsigned int	16	0
26	18446	0x480E	–	Maximum current demand	245	Meter. fct.	Unsigned int	16	0
28	18447	0x480F	LOW	Minimum crest factor	263	Meter. fct.	Unsigned char	8	–1
29	18447	0x480F	HIGH	Maximum crest factor	264	Meter. fct.	Unsigned char	8	–1
30	18448	0x4810	LOW	Minimum form factor	265	Meter. fct.	Unsigned char	8	–1
31	18448	0x4810	HIGH	Maximum form factor	266	Meter. fct.	Unsigned char	8	–1
32	18449	0x4811	–	TS minimum current in phase L1	25	COM35	Time	64	–
40	18453	0x4815	–	TS maximum current in phase L1	26	COM35	Time	64	–
48	18457	0x4819	–	TS minimum current in phase L2	27	COM35	Time	64	–
56	18461	0x481D	–	TS maximum current in phase L2	28	COM35	Time	64	–
64	18465	0x4821	–	TS minimum current in phase L3	29	COM35	Time	64	–
72	18469	0x4825	–	TS maximum current in phase L3	30	COM35	Time	64	–
80	18473	0x4829	–	TS maximum average value over 3 phases	31	COM35	Time	64	–
88	18477	0x482D	–	TS maximum average value over 3 phases	32	COM35	Time	64	–
96	18481	0x4831	–	TS minimum average current demand	55	COM35	Time	64	–
104	18485	0x4835	–	TS maximum average current demand	56	COM35	Time	64	–
112	18489	0x4839	–	TS minimum current in neutral conductor	33	COM35	Time	64	–

4.5 Data sets for SENTRON WL

Byte offset	Modbus register number			Description	Data point	Source WL	Format	Length (bits)	Scaling
	Dec	Hex	High/Low						
120	18493	0x483D	–	TS maximum current in neutral conductor	34	COM35	Time	64	–
128	18497	0x4841	–	TS minimum ground current	35	COM35	Time	64	–
136	18501	0x4845	–	TS maximum ground current	36	COM35	Time	64	–
144	18505	0x4849	–	TS minimum crest factor	65	COM35	Time	64	–
152	18509	0x484D	–	TS maximum crest factor	66	COM35	Time	64	–
160	18513	0x4851	–	TS minimum form factor	67	COM35	Time	64	–
168	18517	0x4855	–	TS maximum form factor	68	COM35	Time	64	–
176	18521	0x4859	–	Reserved	–	–	–	192	–
200	18533	0x4865	LOW	Property byte: Minimum current in phase 1	–	ETU	PB	8	–
201	18533	0x4865	HIGH	Property byte: Maximum current in phase 1	–	ETU	PB	8	–
202	18534	0x4866	LOW	Property byte: Minimum current in phase 2	–	ETU	PB	8	–
203	18534	0x4866	HIGH	Property byte: Maximum current in phase 2	–	ETU	PB	8	–
204	18535	0x4867	LOW	Property byte: Minimum current in phase 3	–	ETU	PB	8	–
205	18535	0x4867	HIGH	Property byte: Maximum current in phase 3	–	ETU	PB	8	–
206	18536	0x4868	LOW	Property byte: Minimum current in neutral conductor	–	ETU	PB	8	–
207	18536	0x4868	HIGH	Property byte: Maximum current in neutral conductor	–	ETU	PB	8	–
208	18537	0x4869	LOW	Property byte: Minimum ground current	–	ETU	PB	8	–
209	18537	0x4869	HIGH	Property byte for byte 18: Maximum ground current	–	ETU	PB	8	–

Byte offset	Modbus register number			Description	Data point	Source WL	Format	Length (bits)	Scaling
	Dec	Hex	High/Low						
210	18538	0x486A	LOW	Property byte: Minimum average value over 3 phases	–	ETU	PB	8	–
211	18538	0x486A	HIGH	Property byte: Maximum average value over 3 phases	–	ETU	PB	8	–
212	18539	0x486B	LOW	Property byte: Minimum current demand	–	Meter. fct.	PB	8	–
213	18539	0x486B	HIGH	Property byte: Maximum current demand	–	Meter. fct.	PB	8	–
214	18540	0x486C	LOW	Property byte: Minimum crest factor	–	Meter. fct.	PB	8	–
215	18540	0x486C	HIGH	Property byte: Maximum crest factor	–	Meter. fct.	PB	8	–
216	18541	0x486D	LOW	Property byte: Minimum form factor	–	Meter. fct.	PB	8	–
217	18541	0x486D	HIGH	Property byte: Maximum form factor	–	Meter. fct.	PB	8	–
218	18542	0x486E	LOW	Property byte: TS minimum current in phase L1	–	COM35	PB	8	–
219	18542	0x486E	HIGH	Property byte: TS maximum current in phase L1	–	COM35	PB	8	–
220	18543	0x486F	LOW	Property byte: TS minimum current in phase L2	–	COM35	PB	8	–
221	18543	0x486F	HIGH	Property byte: TS maximum current in phase L2	–	COM35	PB	8	–
222	18544	0x4870	LOW	Property byte: TS minimum current in phase L3	–	COM35	PB	8	–
223	18544	0x4870	HIGH	Property byte: TS maximum current in phase L3	–	COM35	PB	8	–
224	18545	0x4871	LOW	Property byte: TS minimum average 3-phase current	–	COM35	PB	8	–
225	18545	0x4871	HIGH	Property byte: TS maximum average 3-phase current	–	COM35	PB	8	–

4.5 Data sets for SENTRON WL

Byte offset	Modbus register number			Description	Data point	Source WL	Format	Length (bits)	Scaling
	Dec	Hex	High/Low						
226	18546	0x4872	LOW	Property byte: TS minimum current demand	-	COM35	PB	8	-
227	18546	0x4872	HIGH	Property byte: TS maximum current demand	-	COM35	PB	8	-
228	18547	0x4873	LOW	Property byte: TS minimum current in neutral conductor	-	COM35	PB	8	-
229	18547	0x4873	HIGH	Property byte: TS maximum current in neutral conductor	-	COM35	PB	8	-
230	18548	0x4874	LOW	Property byte: TS minimum ground current	-	COM35	PB	8	-
231	18548	0x4874	HIGH	Property byte: TS maximum ground current	-	COM35	PB	8	-
232	18549	0x4875	LOW	Property byte: TS minimum crest factor	-	COM35	PB	8	-
233	18549	0x4875	HIGH	Property byte: TS maximum crest factor	-	COM35	PB	8	-
234	18550	0x4876	LOW	Property byte: TS minimum form factor	-	COM35	PB	8	-
235	18550	0x4876	HIGH	Property byte: TS maximum form factor	-	COM35	PB	8	-

4.5.9 Data set DS 73: Min./max. measured values of the voltages

The table below shows the content of data set 73 (length 87 Modbus registers, read only) in which the minimum and maximum measured values of the voltages are transmitted. It also contains the associated time stamps for these minimum and maximum measured values.

Table 4- 21 Content of data set 73

Byte offset	Modbus register number			Description	Data point	Source WL	Format	Length (bits)	Scaling
	Dec	Hex	High/Low						
0	18689	0x4901	–	Minimum phase-to-phase voltage L1-L2	205	Meter. fct.	Unsigned int	16	0
2	18690	0x4902	–	Maximum phase-to-phase voltage L1-L2	206	Meter. fct.	Unsigned int	16	0
4	18691	0x4903	–	Minimum phase-to-phase voltage L2-L3	207	Meter. fct.	Unsigned int	16	0
6	18692	0x4904	–	Maximum phase-to-phase voltage L2-L3	208	Meter. fct.	Unsigned int	16	0
8	18693	0x4905	–	Minimum phase-to-phase voltage L3-L1	209	Meter. fct.	Unsigned int	16	0
10	18694	0x4906	–	Maximum phase-to-phase voltage L3-L1	210	Meter. fct.	Unsigned int	16	0
12	18695	0x4907	–	Minimum line-to-neutral voltage L1	211	Meter. fct.	Unsigned int	16	0
14	18696	0x4908	–	Maximum line-to-neutral voltage L1	212	Meter. fct.	Unsigned int	16	0
16	18697	0x4909	–	Minimum line-to-neutral voltage L2	213	Meter. fct.	Unsigned int	16	0
18	18698	0x490A	–	Maximum line-to-neutral voltage L2	214	Meter. fct.	Unsigned int	16	0
20	18699	0x490B	–	Minimum line-to-neutral voltage L3	215	Meter. fct.	Unsigned int	16	0
22	18700	0x490C	–	Maximum line-to-neutral voltage L3	216	Meter. fct.	Unsigned int	16	0
24	18701	0x490D	–	TS minimum phase-to-phase voltage L1-L2	37	COM35	Time	64	–
32	18705	0x4911	–	TS maximum phase-to-phase voltage L1-L2	38	COM35	Time	64	–
40	18709	0x4915	–	TS minimum phase-to-phase voltage L2-L3	39	COM35	Time	64	–
48	18713	0x4919	–	TS maximum phase-to-phase voltage L2-L3	40	COM35	Time	64	–
56	18717	0x491D	–	TS minimum phase-to-phase voltage L3-L1	41	COM35	Time	64	–
64	18721	0x4921	–	TS maximum phase-to-phase voltage L3-L1	42	COM35	Time	64	–
72	18725	0x4925	–	TS minimum line-to-neutral voltage L1	43	COM35	Time	64	–

4.5 Data sets for SENTRON WL

Byte offset	Modbus register number			Description	Data point	Source WL	Format	Length (bits)	Scaling
	Dec	Hex	High/Low						
80	18729	0x4929	–	TS maximum line-to-neutral voltage L1	44	COM35	Time	64	–
88	18733	0x492D	–	TS minimum line-to-neutral voltage L2	45	COM35	Time	64	–
96	18737	0x4931	–	TS maximum line-to-neutral voltage L2	46	COM35	Time	64	–
104	18741	0x4935	–	TS minimum line-to-neutral voltage L3	47	COM35	Time	64	–
112	18745	0x4939	–	TS maximum line-to-neutral voltage L3	48	COM35	Time	64	–
120	18749	0x493D	–	Reserved	–	–	–	240	–
150	18764	0x494C	LOW	Property byte: Minimum phase-to-phase voltage L1-L2	–	Meter. fct.	PB	8	–
151	18764	0x494C	HIGH	Property byte: Maximum phase-to-phase voltage L1-L2	–	Meter. fct.	PB	8	–
152	18765	0x494D	LOW	Property byte: Minimum phase-to-phase voltage L2-L3	–	Meter. fct.	PB	8	–
153	18765	0x494D	HIGH	Property byte: Maximum phase-to-phase voltage L2-L3	–	Meter. fct.	PB	8	–
154	18766	0x494E	LOW	Property byte: Minimum phase-to-phase voltage L3-L1	–	Meter. fct.	PB	8	–
155	18766	0x494E	HIGH	Property byte for byte 10: Maximum phase-to-phase voltage L3-L1	–	Meter. fct.	PB	8	–
156	18767	0x494F	LOW	Property byte: Minimum line-to-neutral voltage L1	–	Meter. fct.	PB	8	–
157	18767	0x494F	HIGH	Property byte: Maximum line-to-neutral voltage L1	–	Meter. fct.	PB	8	–
158	18768	0x4950	LOW	Property byte: Minimum line-to-neutral voltage L2	–	Meter. fct.	PB	8	–
159	18768	0x4950	HIGH	Property byte: Maximum line-to-neutral voltage L2	–	Meter. fct.	PB	8	–
160	18769	0x4951	LOW	Property byte: Minimum line-to-neutral voltage L3	–	Meter. fct.	PB	8	–
161	18769	0x4951	HIGH	Property byte: Maximum line-to-neutral voltage L3	–	Meter. fct.	PB	8	–

Byte offset	Modbus register number			Description	Data point	Source WL	Format	Length (bits)	Scaling
	Dec	Hex	High/Low						
162	18770	0x4952	LOW	Property byte: TS minimum phase-to-phase voltage L1-L2	–	COM35	PB	8	–
163	18770	0x4952	HIGH	Property byte: TS maximum phase-to-phase voltage L1-L2	–	COM35	PB	8	–
164	18771	0x4953	LOW	Property byte: TS minimum phase-to-phase voltage L2-L3	–	COM35	PB	8	–
165	18771	0x4953	HIGH	Property byte for byte 48: TS maximum phase-to-phase voltage L2-L3	–	COM35	PB	8	–
166	18772	0x4954	LOW	Property byte: TS minimum phase-to-phase voltage L3-L1	–	COM35	PB	8	–
167	18772	0x4954	HIGH	Property byte: TS maximum phase-to-phase voltage L3-L1	–	COM35	PB	8	–
168	18773	0x4955	LOW	Property byte: TS minimum line-to-neutral voltage L1	–	COM35	PB	8	–
169	18773	0x4955	HIGH	Property byte: TS maximum line-to-neutral voltage L1	–	COM35	PB	8	–
170	18774	0x4956	LOW	Property byte: TS minimum line-to-neutral voltage L2	–	COM35	PB	8	–
171	18774	0x4956	HIGH	Property byte: TS maximum line-to-neutral voltage L2	–	COM35	PB	8	–
172	18775	0x4957	LOW	Property byte: TS minimum line-to-neutral voltage L3	–	COM35	PB	8	–
173	18775	0x4957	HIGH	Property byte: TS maximum line-to-neutral voltage L3	–	COM35	PB	8	–

4.5.10 Data set DS 74: Min./max. measured values of the powers

The table below shows the content of data set 74 in which the minimum and maximum measured values of the powers are transmitted. It also contains the associated time stamps for these minimum and maximum measured values.

Table 4- 22 Content of data set 74

Byte offset	Modbus register number			Description	Data point	Source WL	Format	Length (bits)	Scaling
	Dec	Hex	High/Low						
0	18945	0x4A01	–	Minimum average power factor (3-phase)	242	Meter. fct.	Signed int	16	–3
2	18946	0x4A02	–	Maximum average power factor (3-phase)	243	Meter. fct.	Signed int	16	–3
4	18947	0x4A03	–	Minimum average value of apparent power (3-phase)	246	Meter. fct.	Unsigned int	16	0
6	18948	0x4A04	–	Maximum average value of apparent power (3-phase)	247	Meter. fct.	Unsigned int	16	0
8	18949	0x4A05	–	Minimum average value of active power (3-phase)	250	Meter. fct.	Unsigned int	16	0
10	18950	0x4A06	–	Maximum average value of active power (3-phase)	251	Meter. fct.	Unsigned int	16	0
12	18951	0x4A07	–	Minimum average value of reactive power (3-phase)	248	Meter. fct.	Unsigned int	16	0
14	18952	0x4A08	–	Maximum average value of reactive power (3-phase)	249	Meter. fct.	Unsigned int	16	0
16	18953	0x4A09	–	TS minimum average value of apparent power (3-phase)	57	COM35	Time	64	–
24	18957	0x4A0D	–	TS maximum average value of apparent power (3-phase)	58	COM35	Time	64	–
32	18961	0x4A11	–	TS minimum average value of active power (3-phase)	49	COM35	Time	64	–
40	18965	0x4A15	–	TS maximum average value of active power (3-phase)	50	COM35	Time	64	–
48	18969	0x4A19	–	TS minimum average value of reactive power (3-phase)	51	COM35	Time	64	–
56	18973	0x4A1D	–	TS maximum average value of reactive power (3-phase)	52	COM35	Time	64	–

Byte offset	Modbus register number			Description	Data point	Source WL	Format	Length (bits)	Scaling
	Dec	Hex	High/Low						
64	18977	0x4A21	–	TS minimum average value of the power factor (3-phase)	53	COM35	Time	64	–
72	18981	0x4A25	–	TS maximum average value of the power factor (3-phase)	54	COM35	Time	64	–
80	18985	0x4A29	–	Reserved	–	–	–	320	–
120	19005	0x4A3D	LOW	Property byte: Minimum average power factor (3-phase)	–	Meter. fct.	PB	8	–
121	19005	0x4A3D	HIGH	Property byte: Maximum average power factor (3-phase)	–	Meter. fct.	PB	8	–
122	19006	0x4A3E	LOW	Property byte: Minimum average value of apparent power (3-phase)	–	Meter. fct.	PB	8	–
123	19006	0x4A3E	HIGH	Property byte: Maximum average value of apparent power (3-phase)	–	Meter. fct.	PB	8	–
124	19007	0x4A3F	LOW	Property byte: Minimum average value of active power (3-phase)	–	Meter. fct.	PB	8	–
125	19007	0x4A3F	HIGH	Property byte: Maximum average value of active power (3-phase)	–	Meter. fct.	PB	8	–
126	19008	0x4A40	LOW	Property byte: Minimum average value of reactive power (3-phase)	–	Meter. fct.	PB	8	–
127	19008	0x4A40	HIGH	Property byte: Maximum average value of reactive power (3-phase)	–	Meter. fct.	PB	8	–
128	19009	0x4A41	LOW	Property byte: TS minimum average value of apparent power (3-phase)	–	COM35	PB	8	–
129	19009	0x4A41	HIGH	Property byte: TS maximum average value of apparent power (3-phase)	–	COM35	PB	8	–
130	19010	0x4A42	LOW	Property byte: TS minimum average value of active power (3-phase)	–	COM35	PB	8	–

4.5 Data sets for SENTRON WL

Byte offset	Modbus register number			Description	Data point	Source WL	Format	Length (bits)	Scaling
	Dec	Hex	High/Low						
131	19010	0x4A42	HIGH	Property byte: TS maximum average value of active power (3-phase)	–	COM35	PB	8	–
132	19011	0x4A43	LOW	Property byte: TS minimum average value of reactive power (3-phase)	–	COM35	PB	8	–
133	19011	0x4A43	HIGH	Property byte: TS maximum average value of reactive power (3-phase)	–	COM35	PB	8	–
134	19012	0x4A44	LOW	Property byte: TS minimum average value of the power factor (3-phase)	–	COM35	PB	8	–
135	19012	0x4A44	HIGH	Property byte: TS maximum average value of the power factor (3-phase)	–	COM35	PB	8	–

4.5.11 Data set DS 76: Min./max. measured values of frequency and THD

The table below shows the content of data set 76 (length 46 Modbus registers, read only) in which the minimum and maximum measured values of the frequency and total harmonic distortion are transmitted. It also contains the associated time stamps for these minimum and maximum measured values.

Table 4- 23 Content of data set 76

Byte offset	Modbus register number			Description	Data point	Source WL	Format	Length (bits)	Scaling
	Dec	Hex	High/Low						
0	19457	0x4C01	–	Maximum frequency	253	Meter. fct.	Unsigned int	16	–2
2	19458	0x4C02	–	Minimum frequency	252	Meter. fct.	Unsigned int	16	–2
4	19459	0x4C03	LOW	Minimum THD current	255	Meter. fct.	Unsigned char	8	0
5	19459	0x4C03	HIGH	Maximum THD current	256	Meter. fct.	Unsigned char	8	0
6	19460	0x4C04	LOW	Minimum THD voltage	258	Meter. fct.	Unsigned char	8	0
7	19460	0x4C04	HIGH	Maximum THD voltage	259	Meter. fct.	Unsigned char	8	0
8	19461	0x4C05	–	TS minimum frequency	59	COM35	Time	64	–

Byte offset	Modbus register number			Description	Data point	Source WL	Format	Length (bits)	Scaling
	Dec	Hex	High/Low						
16	19465	0x4C09	–	TS maximum frequency	60	COM35	Time	64	–
24	19469	0x4C0D	–	TS minimum THD current	61	COM35	Time	64	–
32	19473	0x4C11	–	TS maximum THD current	62	COM35	Time	64	–
40	19477	0x4C15	–	TS minimum THD voltage	63	COM35	Time	64	–
48	19481	0x4C19	–	TS maximum THD voltage	64	COM35	Time	64	–
56	19485	0x4C1D	–	Reserved	–	–	–	192	–
80	19497	0x4C29	LOW	Property byte: Maximum frequency	–	Meter. fct.	PB	8	–
81	19497	0x4C29	HIGH	Property byte: Minimum frequency	–	Meter. fct.	PB	8	–
82	19498	0x4C2A	LOW	Property byte: Minimum THD current	–	Meter. fct.	PB	8	–
83	19498	0x4C2A	HIGH	Property byte: Maximum THD current	–	Meter. fct.	PB	8	–
84	19499	0x4C2B	LOW	Property byte: Minimum THD voltage	–	Meter. fct.	PB	8	–
85	19499	0x4C2B	HIGH	Property byte: Maximum THD voltage	–	Meter. fct.	PB	8	–
86	19500	0x4C2C	LOW	Property byte: TS minimum frequency	–	COM35	PB	8	–
87	19500	0x4C2C	HIGH	Property byte: TS maximum frequency	–	COM35	PB	8	–
88	19501	0x4C2D	LOW	Property byte: TS minimum THD current	–	COM35	PB	8	–
89	19501	0x4C2D	HIGH	Property byte: TS maximum THD current	–	COM35	PB	8	–
90	19502	0x4C2E	LOW	Property byte: TS minimum THD voltage	–	COM35	PB	8	–
91	19502	0x4C2E	HIGH	Property byte: TS maximum THD voltage	–	COM35	PB	8	–

4.5.12 Data set DS 77: Min./max. measured values of the temperatures

The table below shows the content of data set 77 in which the minimum and maximum measured values of the temperatures are transmitted. It also contains the associated time stamps for these minimum and maximum measured values.

Table 4- 24 Content of data set 77

Byte offset	Modbus register number			Description	Data point	Source WL	Format	Length (bits)	Scaling
	Dec	Hex	High/Low						
0	19713	0x4D01	LOW	Minimum temperature in the cubicle	72	COM35	Signed char	8	0
1	19713	0x4D01	HIGH	Maximum temperature in the cubicle	73	COM35	Signed char	8	0
2	19714	0x4D02	LOW	Minimum temperature in the circuit breaker	74	BSS	Signed char	8	0
3	19714	0x4D02	HIGH	Maximum temperature in the circuit breaker	75	BSS	Signed char	8	0
4	19715	0x4D03	–	TS minimum temperature in the cubicle	76	COM35	Time	64	–
12	19719	0x4D07	–	TS maximum temperature in the cubicle	77	COM35	Time	64	–
20	19723	0x4D0B	–	TS minimum temperature in the circuit breaker	78	COM35	Time	64	–
28	19727	0x4D0F	–	TS maximum temperature in the circuit breaker	79	COM35	Time	64	–
36	19731	0x4D13	–	Reserved	–	–	–	112	–
50	19738	0x4D1A	LOW	Property byte: Minimum temperature in the cubicle	–	COM35	PB	8	–
51	19738	0x4D1A	HIGH	Property byte: Maximum temperature in the cubicle	–	COM35	PB	8	–
52	19739	0x4D1B	LOW	Property byte: Minimum temperature in the circuit breaker	–	BSS	PB	8	–
53	19739	0x4D1B	HIGH	Property byte: Maximum temperature in the circuit breaker	–	BSS	PB	8	–
54	19740	0x4D1C	LOW	Property byte: TS minimum temperature in the cubicle	–	COM35	PB	8	–
55	19740	0x4D1C	HIGH	Property byte: TS maximum temperature in the cubicle	–	COM35	PB	8	–

Byte offset	Modbus register number			Description	Data point	Source WL	Format	Length (bits)	Scaling
	Dec	Hex	High/Low						
56	19741	0x4D1D	LOW	Property byte: TS minimum temperature in the circuit breaker	–	COM35	PB	8	–
57	19741	0x4D1D	HIGH	Property byte: TS maximum temperature in the circuit breaker	–	COM35	PB	8	–

4.5.13 Data set DS 91: Statistical information

The table below shows the content of data set 91 (length 42 Modbus registers, read only) in which the statistical information on the SENTRON circuit breakers is transmitted. As with the other data sets, the property of each data point is additionally transmitted in the property byte.

Table 4- 25 Content of data set 91

Byte offset	Modbus register number			Description	Data point	Source WL	Format	Length (bits)	Scaling
	Dec	Hex	High/Low						
0	23297	0x5B01	–	Number of open/close operations under load	80	COM35	Unsigned int	16	0
2	23298	0x5B02	–	Number of open/close operations caused by trips	81	COM35	Unsigned int	16	0
4	23299	0x5B03	–	Count of open/close operations	82	COM35	Unsigned int	16	0
6	23300	0x5B04	–	Runtime meter (when closed + current > 0)	83	COM35	Unsigned long	32	0
10	23302	0x5B06	–	Date of the last parameter change	84	COM35	Time	64	–
18	23306	0x5B0A	–	Number of short-circuit trips (S & I)	104	ETU	Unsigned int	16	0
20	23307	0x5B0B	–	Number of LT/overload trips	105	ETU	Unsigned int	16	0
22	23308	0x5B0C	–	Number of ground-fault trips (G)	106	ETU	Unsigned int	16	0
24	23309	0x5B0D	–	Sum of interrupted I ² t values L1, L2, L3, N	107	ETU	Format (107)	128	0
40	23317	0x5B15	LOW	Maintenance information about the main contacts	405	ETU	Format (405)	2	–
41	23317	0x5B15	–	Reserved	–	–	–	56	–
48	23321	0x5B19	–	Modules connected to the CubicleBUS	88	COM35	Format (88)	32	–
52	23323	0x5B1B	–	Reserved	–	–	–	144	–

4.5 Data sets for SENTRON WL

Byte offset	Modbus register number			Description	Data point	Source WL	Format	Length (bits)	Scaling
	Dec	Hex	High/Low						
70	23332	0x5B24	LOW	Property byte: Number of open/close operations under load	–	COM35	PB	8	–
71	23332	0x5B24	HIGH	Property byte: Number of open/close operations caused by trips	–	COM35	PB	8	–
72	23333	0x5B25	LOW	Property byte: Count of open/close operations	–	COM35	PB	8	–
73	23333	0x5B25	HIGH	Property byte: Runtime meter (when closed + current > 0)	–	COM35	PB	8	–
74	23334	0x5B26	LOW	Property byte: Date of the last parameter change	–	COM35	PB	8	–
75	23334	0x5B26	HIGH	Property byte: Number of short-circuit trips (S & I)	–	ETU	PB	8	–
76	23335	0x5B27	LOW	Property byte: Number of LT/overload trips	–	ETU	PB	8	–
77	23335	0x5B27	HIGH	Property byte: Number of ground-fault trips (G)	–	ETU	PB	8	–
78	23336	0x5B28	LOW	Property byte: Sum of interrupted I ² t values L1, L2, L3, N	–	ETU	PB	8	–
79	23336	0x5B28	HIGH	Property byte: Maintenance information about the main contacts	–	ETU	PB	8	–
80	23337	0x5B29	–	Reserved	–	–	–	24	–
83	23338	0x5B2A	HIGH	Property byte: Modules connected to the CubicleBUS	–	COM35	PB	8	–

4.5.14 Data set DS 92: Diagnostic data

The table below shows the content of data set 92, diagnostic data (length 97 Modbus registers, read only) in which the data for detailed diagnostics of the SENTRON circuit breakers is transmitted.

Table 4- 26 Content of data set 92

Byte offset	Modbus register number			Description	Data point	Source WL	Format	Length (bits)	Scaling
	Dec	Hex	High/Low						
0	23553	0x5C01	LOW	Reserved	–	COM35	–	32	–
4	23555	0x5C03	–	SENTRON identification number (0x0E05)	–	COM35	Hex	16	–
6	23556	0x5C04	LOW	Fixed value 0x42	–	COM35	Hex	8	–
7	23556	0x5C04	HIGH	External diagnostic bit <ul style="list-style-type: none"> • 1 = Diagnosis • 0 = No diagnosis 	–	COM35	Hex	1	–
8	23557	0x5C05	–	Fixed header; value 0x05 82 00 00 00	–	COM35	Hex	40	–
13	23559	0x5C07	HIGH	Reserved	–	–	Unsigned char	56	–
20	23563	0x5C0B	–	Modules connected to the CubicleBUS	88	COM35	Format (88)	32	–
24	23565	0x5C0D	–	Currently pending warnings	402	ETU	Format (402)	16	–
26	23566	0x5C0E	LOW	Last unacknowledged trip by the trip unit	401	ETU	Format (401)	8	–
27	23566	0x5C0E	HIGH	Reserved	–	–	Unsigned char	8	–
28	23567	0x5C0F	–	Count of trips by extended protective functions	307	Meter. fct.	Format (307)	16	–
30	23568	0x5C10	–	Setpoint alarms	308	Meter. fct.	Format (308)	32	–
34	23570	0x5C12	–	Last current measured prior to trip	403	ETU	Unsigned int	16	1
36	23571	0x5C13	LOW	Phase causing the trip	404	ETU	Format (373)	3	–
37	23571	0x5C13	HIGH	Position of the circuit breaker in the frame	24	COM35	Format (24)	4	–
38	23572	0x5C14	–	Reserved	–	–	Unsigned char	16	–
40	23573	0x5C15	LOW	Status of the circuit breaker (e.g. open/closed/charged)	328	BSS	Format (328)	8	–
41	23573	0x5C15	HIGH	Reserved	–	–	Unsigned char	8	–

4.5 Data sets for SENTRON WL

Byte offset	Modbus register number			Description	Data point	Source WL	Format	Length (bits)	Scaling
	Dec	Hex	High/Low						
42	23574	0x5C16	–	Event log of the last 10 events with time stamp	16	COM35	Format (16)	960	–
162	23634	0x5C52	–	Reserved	–	–	Unsigned char	144	–
180	23643	0x5C5B	LOW	Property byte: Modules connected to the CubicleBUS	–	COM35	PB	8	–
181	23643	0x5C5B	HIGH	Property byte: Currently pending warnings	–	ETU	PB	8	–
182	23644	0x5C5C	LOW	Property byte: Last unacknowledged trip by the trip unit	–	ETU	PB	8	–
183	23644	0x5C5C	HIGH	Property byte: Trips by extended protection functions	–	Meter. fct.	PB	8	–
184	23645	0x5C5D	LOW	Property byte: Setpoint alarms	–	Meter. fct.	PB	8	–
185	23645	0x5C5D	HIGH	Property byte: Last current measured prior to trip	–	ETU	PB	8	–
186	23646	0x5C5E	LOW	Property byte: Phase causing the trip	–	ETU	PB	8	–
187	23646	0x5C5E	HIGH	Property byte: Position of the circuit breaker in the frame	–	COM35	PB	8	–
188	23647	0x5C5F	LOW	Reserved	–	–	Unsigned char	8	–
189	23647	0x5C5F	HIGH	Property byte: Status of the circuit breaker (e.g. open/closed/charged)	–	BSS	PB	8	–
190	23648	0x5C60	LOW	Property byte: Event log of the last 10 events with time stamp	–	COM35	PB	8	–
191	23648	0x5C60	–	Reserved	–	–	Unsigned char	24	–

4.5.15 Data set DS 93: Controlling the circuit breakers

The table below shows the content of data set 93, controlling the circuit breakers (length 14 Modbus registers, write only), by which the SENTRON circuit breakers are closed, the min./max. buffers cleared, the outputs of the digital output modules forced, and the six available communication bits (can be output via the configurable digital output module) are set.

Table 4- 27 Content of data set 93

Byte offset	Modbus register number			Description	Data point	Source WL	Format	Length (bits)	Scaling
	Dec	Hex	High/Low						
0	23809	0x5D01	–	Header; value 0x00 00 00 00	–	COM35	–	32	–
4	23811	0x5D03	–	Controls the trip unit	406	ETU	Format (406)	16	–
6	23812	0x5D04	–	Reserved	–	–	Unsigned char	16	–
8	23813	0x5D05	LOW	Controls digital output module 1	121	DO1	Format (121)	8	–
9	23813	0x5D05	HIGH	Controls digital output module 2	126	DO2	Format (126)	8	–
10	23814	0x5D06	LOW	Clears various logs and counters	18	COM35	Format (18)	8	–
11	23814	0x5D06	HIGH	Reserved	–	COM35	–	8	–
12	23815	0x5D07	LOW	Reserved	–	–	Unsigned char	8	–
13	23815	0x5D07	HIGH	6 communication module bits for the configurable digital output module	426	COM35	Format (426)	6	–
14	23816	0x5D08	–	Reserved	–	–	Unsigned char	40	–
19	23818	0x5D0A	HIGH	Property byte: 6 communication module bits for the configurable digital output module	–	COM35	PB	8	–
20	23819	0x5D0B	LOW	Property byte: Controls the trip unit	–	ETU	PB	8	–
21	23819	0x5D0B	HIGH	Property byte: Re-served	–	Meter. fct.	PB	8	–
22	23820	0x5D0C	LOW	Property byte: Controls digital output module 1	–	DO1	PB	8	–
23	23820	0x5D0C	HIGH	Property byte: Controls digital output module 2	–	DO2	PB	8	–
24	23821	0x5D0D	LOW	Property byte: Clears various logs and counters	–	COM35	PB	8	–

4.5 Data sets for SENTRON WL

Byte offset	Modbus register number			Description	Data point	Source WL	Format	Length (bits)	Scaling
	Dec	Hex	High/Low						
25	23821	0x5D0D	HIGH	Property byte: Controls the outputs of the communication module (e.g. open/close the circuit breaker)	–	COM35	PB	8	–
26	23822	0x5D0E	LOW	Reserved	–	–	Unsigned char	8	–

4.5.16 Data set DS 94: Current measured values

The table below shows the content of data set 94 in which all current measured values are transmitted. The additional property bytes provide information on the availability and correctness of the current measured values (length 99 Modbus registers, read only).

Table 4- 28 Content of data set 94 Modbus register address hex: 0x5E0x (dec: 24065 to 24079)

Byte offset	Modbus register number			Description	Data point	Source WL	Format	Length (bits)	Scaling
	Dec	Hex	High/Low						
0	24065	0x5E01	LOW	Phase unbalance current (%)	172	Meter. fct.	Unsigned char	8	0
1	24065	0x5E01	HIGH	Reserved	–	–	Unsigned char	8	–
2	24066	0x5E02	–	3-phase current demand	193	Meter. fct.	Unsigned int	16	0
4	24067	0x5E03	–	Current demand L1	194	Meter. fct.	Unsigned int	16	0
6	24068	0x5E04	–	Current demand L2	195	Meter. fct.	Unsigned int	16	0
8	24069	0x5E05	–	Current demand L3	196	Meter. fct.	Unsigned int	16	0
10	24070	0x5E06	–	Current in phase L1	380	ETU	Unsigned int	16	0
12	24071	0x5E07	–	Current in phase L2	381	ETU	Unsigned int	16	0
14	24072	0x5E08	–	Current in phase L3	382	ETU	Unsigned int	16	0
16	24073	0x5E09	–	Average 3-phase current	383	ETU	Unsigned int	16	0
18	24074	0x5E0A	–	Current in neutral conductor	375	ETU	Unsigned int	16	0
20	24075	0x5E0B	–	Ground current	376	ETU	Unsigned int	16	0
22	24076	0x5E0C	LOW	Phase unbalance voltage (%)	173	Meter. fct.	Unsigned char	8	0
23	24076	0x5E0C	HIGH	Reserved	–	–	–	8	–

Byte offset	Modbus register number			Description	Data point	Source WL	Format	Length (bits)	Scaling
	Dec	Hex	High/Low						
24	24077	0x5E0D	–	Phase-to-phase voltage L1-L2	197	Meter. fct.	Unsigned int	16	0
26	24078	0x5E0E	–	Phase-to-phase voltage L2-L3	198	Meter. fct.	Unsigned int	16	0
28	24079	0x5E0F	–	Phase-to-phase voltage L3-L1	199	Meter. fct.	Unsigned int	16	0

Table 4- 29 Content of data set 94 Modbus register address hex: 0x5E1x (dec: 24080 to 24095)

Byte offset	Modbus register number			Description	Data point	Source WL	Format	Length (bits)	Scaling
	Dec	Hex	High/Low						
30	24080	0x5E10	–	Line-to-neutral voltage L1	200	Meter. fct.	Unsigned int	16	0
32	24081	0x5E11	–	Line-to-neutral voltage L2	201	Meter. fct.	Unsigned int	16	0
34	24082	0x5E12	–	Line-to-neutral voltage L3	202	Meter. fct.	Unsigned int	16	0
36	24083	0x5E13	–	Average phase-to-phase voltage	203	Meter. fct.	Unsigned int	16	0
38	24084	0x5E14	–	Average value of line-to-neutral voltage	204	Meter. fct.	Unsigned int	16	0
40	24085	0x5E15	–	Total apparent power	217	Meter. fct.	Unsigned int	16	0
42	24086	0x5E16	–	Total active power	221	Meter. fct.	Signed int	16	0
44	24087	0x5E17	–	Active power in phase L1	222	Meter. fct.	Signed int	16	0
46	24088	0x5E18	–	Active power in phase L2	223	Meter. fct.	Signed int	16	0
48	24089	0x5E19	–	Active power in phase L3	224	Meter. fct.	Signed int	16	0
50	24090	0x5E1A	–	Total reactive power	225	Meter. fct.	Signed int	16	0
52	24091	0x5E1B	–	3-phase active power demand	229	Meter. fct.	Signed int	16	0
54	24092	0x5E1C	–	Active power demand phase L1	230	Meter. fct.	Signed int	16	0
56	24093	0x5E1D	–	Active power demand phase L2	231	Meter. fct.	Signed int	16	0
58	24094	0x5E1E	–	Active power demand phase L3	232	Meter. fct.	Signed int	16	0
60	24095	0x5E1F	–	3-phase apparent power demand	233	Meter. fct.	Unsigned int	16	0

4.5 Data sets for SENTRON WL

Table 4- 30 Content of data set 94 Modbus register address hex: 0x5E2x (dec: 24096 to 24110)

Byte offset	Modbus register number			Description	Data point	Source WL	Format	Length (bits)	Scaling
	Dec	Hex	High/Low						
62	24096	0x5E20	–	Apparent power in phase L1	218	Meter. fct.	Unsigned int	16	0
64	24097	0x5E21	–	Apparent power in phase L2	219	Meter. fct.	Unsigned int	16	0
66	24098	0x5E22	–	Apparent power in phase L3	220	Meter. fct.	Unsigned int	16	0
68	24099	0x5E23	–	Apparent power demand in phase L1	234	Meter. fct.	Unsigned int	16	0
70	24100	0x5E24	–	Apparent power demand in phase L2	235	Meter. fct.	Unsigned int	16	0
72	24101	0x5E25	–	Apparent power demand in phase L3	236	Meter. fct.	Unsigned int	16	0
74	24102	0x5E26	–	3-phase active power demand	237	Meter. fct.	Signed int	16	0
76	24103	0x5E27	–	Reactive power in phase L1	226	Meter. fct.	Signed int	16	0
78	24104	0x5E28	–	Reactive power in phase L2	227	Meter. fct.	Signed int	16	0
80	24105	0x5E29	–	Reactive power in phase L3	228	Meter. fct.	Signed int	16	0
82	24106	0x5E2A	–	Active energy in normal direction [MWh]	238	Meter. fct.	Unsigned long	32	0
86	24108	0x5E2C	–	Active energy in reverse direction [MWh]	239	Meter. fct.	Unsigned long	32	0
90	24110	0x5E2E	–	Reactive energy in normal direction [MVARh]	240	Meter. fct.	Unsigned long	32	0

Table 4- 31 Content of data set 94 Modbus register address hex: 0x5E3x (dec: 24112 to 24127)

Byte offset	Modbus register number			Description	Data point	Source WL	Format	Length (bits)	Scaling
	Dec	Hex	High/Low						
94	24112	0x5E30	–	Reactive energy in reverse direction [MVARh]	241	Meter. fct.	Unsigned long	32	0
98	24114	0x5E32	–	Average power factor, 3-phase	168	Meter. fct.	Signed int	16	–3
100	24115	0x5E33	–	Power factor in phase L1	169	Meter. fct.	Signed int	16	–3
102	24116	0x5E34	–	Power factor in phase L2	170	Meter. fct.	Signed int	16	–3
104	24117	0x5E35	–	Power factor in phase L3	171	Meter. fct.	Signed int	16	–3

Byte offset	Modbus register number			Description	Data point	Source WL	Format	Length (bits)	Scaling
	Dec	Hex	High/Low						
106	24118	0x5E36	–	Frequency	262	Meter. fct.	Unsigned int	16	–2
108	24119	0x5E37	LOW	THD current	254	Meter. fct.	Unsigned char	8	0
109	24119	0x5E37	HIGH	THD voltage	257	Meter. fct.	Unsigned char	8	0
110	24120	0x5E38	LOW	Form factor	261	Meter. fct.	Unsigned char	8	–1
111	24120	0x5E38	HIGH	Crest factor	260	Meter. fct.	Unsigned char	8	–1
114	24122	0x5E3A	LOW	Temperature in the cubicle (measured in the COM35)	71	COM35	Signed char	8	0
115	24122	0x5E3A	HIGH	Temperature in circuit breaker (measured in the BSS)	330	BSS	Signed char	8	0
116	24123	0x5E3B	–	Active energy in normal direction [kWh]	433	Meter. fct.	Unsigned long	32	–
120	24125	0x5E3D	–	Active energy in reverse direction [kWh]	434	Meter. fct.	Unsigned long	32	–
124	24127	0x5E3F	–	Reactive energy in normal direction [kVARh]	435	Meter. fct.	Unsigned long	32	–

Table 4- 32 Content of data set 94 Modbus register address hex: 0x5E4x (dec: 24129 to 24143)

Byte offset	Modbus register number			Description	Data point	Source WL	Format	Length (bits)	Scaling
	Dec	Hex	High/Low						
128	24129	0x5E41	–	Reactive energy in reverse direction [kVARh]	436	Meter. fct.	Unsigned long	32	–
132	24131	0x5E43	–	Reserved	–	–	Unsigned char	32	–
136	24133	0x5E45	LOW	Property byte: Active energy in normal direction	–	Meter. fct.	PB	8	–
137	24133	0x5E45	HIGH	Property byte: Active energy in reverse direction	–	Meter. fct.	PB	8	–
138	24134	0x5E46	LOW	Property byte: Reactive energy in normal direction	–	Meter. fct.	PB	8	–
139	24134	0x5E46	HIGH	Property byte: Reactive energy in reverse direction	–	Meter. fct.	PB	8	–

4.5 Data sets for SENTRON WL

Byte offset	Modbus register number			Description	Data point	Source WL	Format	Length (bits)	Scaling
	Dec	Hex	High/Low						
140	24135	0x5E47	LOW	Property byte: Phase unbalance current (%)	–	Meter. fct.	PB	8	–
141	24135	0x5E47	HIGH	Property byte: 3-phase current demand	–	Meter. fct.	PB	8	–
142	24136	0x5E48	LOW	Property byte: Current demand L1	–	Meter. fct.	PB	8	–
143	24136	0x5E48	HIGH	Property byte: Current demand L2	–	Meter. fct.	PB	8	–
144	24137	0x5E49	LOW	Property byte: Current demand L3	–	Meter. fct.	PB	8	–
145	24137	0x5E49	HIGH	Property byte: Current in phase L1	–	ETU	PB	8	–
146	24138	0x5E4A	LOW	Property byte: Current in phase L2	–	ETU	PB	8	–
147	24138	0x5E4A	HIGH	Property byte: Current in phase L3	–	ETU	PB	8	–
148	24139	0x5E4B	LOW	Property byte: Average 3-phase current	–	ETU	PB	8	–
149	24139	0x5E4B	HIGH	Property byte: Current in neutral conductor	–	ETU	PB	8	–
150	24140	0x5E4C	LOW	Property byte: Ground current	–	ETU	PB	8	–
151	24140	0x5E4C	HIGH	Property byte: Phase unbalance voltage (%)	–	Meter. fct.	PB	8	–
152	24141	0x5E4D	LOW	Property byte: Phase-to-phase voltage L1-L2	–	Meter. fct.	PB	8	–
153	24141	0x5E4D	HIGH	Property byte: Phase-to-phase voltage L2-L3	–	Meter. fct.	PB	8	–
154	24142	0x5E4E	LOW	Property byte: Phase-to-phase voltage L3-L1	–	Meter. fct.	PB	8	–
155	24142	0x5E4E	HIGH	Property byte: Line-to-neutral voltage L1	–	Meter. fct.	PB	8	–
156	24143	0x5E4F	LOW	Property byte: Line-to-neutral voltage L2	–	Meter. fct.	PB	8	–
157	24143	0x5E4F	HIGH	Property byte: Line-to-neutral voltage L3	–	Meter. fct.	PB	8	–

Table 4- 33 Content of data set 94 Modbus register address hex: 0x5E5x (dec: 24144 to 24159)

Byte offset	Modbus register number			Description	Data point	Source WL	Format	Length (bits)	Scaling
	Dec	Hex	High/Low						
158	24144	0x5E50	LOW	Property byte: Average phase-to-phase voltage	–	Meter. fct.	PB	8	–
159	24144	0x5E50	HIGH	Property byte: Average value of line-to-neutral voltage	–	Meter. fct.	PB	8	–
160	24145	0x5E51	LOW	Property byte: Total apparent power	–	Meter. fct.	PB	8	–
161	24145	0x5E51	HIGH	Property byte: Total active power	–	Meter. fct.	PB	8	–
162	24146	0x5E52	LOW	Property byte: Active power in phase L1	–	Meter. fct.	PB	8	–
163	24146	0x5E52	HIGH	Property byte: Active power in phase L2	–	Meter. fct.	PB	8	–
164	24147	0x5E53	LOW	Property byte: Active power in phase L3	–	Meter. fct.	PB	8	–
165	24147	0x5E53	HIGH	Property byte: Total reactive power	–	Meter. fct.	PB	8	–
166	24148	0x5E54	LOW	Property byte: 3-phase active power demand	–	Meter. fct.	PB	8	–
167	24148	0x5E54	HIGH	Property byte: Active power demand phase L1	–	Meter. fct.	PB	8	–
168	24149	0x5E55	LOW	Property byte: Active power demand phase L2	–	Meter. fct.	PB	8	–
169	24149	0x5E55	HIGH	Property byte: Active power demand phase L3	–	Meter. fct.	PB	8	–
170	24150	0x5E56	LOW	Property byte: 3-phase apparent power demand	–	Meter. fct.	PB	8	–
171	24150	0x5E56	HIGH	Property byte: Apparent power in phase L1	–	Meter. fct.	PB	8	–
172	24151	0x5E57	LOW	Property byte: Apparent power in phase L2	–	Meter. fct.	PB	8	–
173	24151	0x5E57	HIGH	Property byte: Apparent power in phase L3	–	Meter. fct.	PB	8	–
174	24152	0x5E58	LOW	Property byte: Apparent power demand in phase L1	–	Meter. fct.	PB	8	–
175	24152	0x5E58	HIGH	Property byte: Apparent power demand in phase L2	–	Meter. fct.	PB	8	–

4.5 Data sets for SENTRON WL

Byte offset	Modbus register number			Description	Data point	Source WL	Format	Length (bits)	Scaling
	Dec	Hex	High/Low						
176	24153	0x5E59	LOW	Property byte: Apparent power demand in phase L3	–	Meter. fct.	PB	8	–
177	24153	0x5E59	HIGH	Property byte: 3-phase active power demand	–	Meter. fct.	PB	8	–
178	24154	0x5E5A	LOW	Property byte: Reactive power in phase L1	–	Meter. fct.	PB	8	–
179	24154	0x5E5A	HIGH	Property byte: Reactive power in phase L2	–	Meter. fct.	PB	8	–
180	24155	0x5E5B	LOW	Property byte: Reactive power in phase L3	–	Meter. fct.	PB	8	–
181	24155	0x5E5B	HIGH	Property byte: Active energy in normal direction	–	Meter. fct.	PB	8	–
182	24156	0x5E5C	LOW	Property byte: Active energy in reverse direction	–	Meter. fct.	PB	8	–
183	24156	0x5E5C	HIGH	Property byte: Reactive energy in normal direction	–	Meter. fct.	PB	8	–
184	24157	0x5E5D	LOW	Property byte: Reactive energy in reverse direction	–	Meter. fct.	PB	8	–
185	24157	0x5E5D	HIGH	Property byte: Average power factor, 3-phase	–	Meter. fct.	PB	8	–
186	24158	0x5E5E	LOW	Property byte: Power factor in phase L1	–	Meter. fct.	PB	8	–
187	24158	0x5E5E	HIGH	Property byte: Power factor in phase L2	–	Meter. fct.	PB	8	–
188	24159	0x5E5F	LOW	Property byte: Power factor in phase L3	–	Meter. fct.	PB	8	–
189	24159	0x5E5F	HIGH	Property byte: Frequency	–	Meter. fct.	PB	8	–

Table 4- 34 Content of data set 94 Modbus register address hex: 0x5E6x (dec: 24160 to 24163)

Byte offset	Modbus register number			Description	Data point	Source WL	Format	Length (bits)	Scaling
	Dec	Hex	High/Low						
190	24160	0x5E60	LOW	Property byte: THD current	–	Meter. fct.	PB	8	–
191	24160	0x5E60	HIGH	Property byte: THD voltage	–	Meter. fct.	PB	8	–
192	24161	0x5E61	LOW	Property byte: Form factor	–	Meter. fct.	PB	8	–
193	24161	0x5E61	HIGH	Property byte: Crest factor	–	Meter. fct.	PB	8	–
194	24162	0x5E62	LOW	Reserved	–	–	–	–	–
195	24162	0x5E62	HIGH	Property byte: Temperature in the cubicle (measured in the COM35)	–	COM35	PB	8	–
196	24163	0x5E63	LOW	Property byte: Temperature in circuit breaker (measured in the BSS)	–	BSS	PB	8	–

4.5.17 Data set DS 97: Detailed identification

The following table shows the content of data set 97 – Detailed identification (length 112 Modbus registers, read only) from which all necessary information for precise identification of the SENTRON circuit breakers can be obtained.

Table 4- 35 Content of data set 97

Byte offset	Modbus register number			Description	Data point	Source WL	Format	Length (bits)	Scaling
	Dec	Hex	High/Low						
0	24833	0x6101	–	Part number of the trip unit	407	ETU	16 x char	144	–
18	24842	0x610A	–	Date of manufacture of trip unit	408	ETU	Time	64	–
26	24846	0x610E	–	Identification number of trip unit	409	ETU	17 x char	136	–
43	24854	0x6116	HIGH	Reserved	–	–	–	8	–
44	24855	0x6117	LOW	Ground-fault sensing method	410	ETU	Format (410)	2	–
45	24855	0x6117	HIGH	Neutral CT connected	411	ETU	Format (411)	1	–
46	24856	0x6118	LOW	Reserved	–	–	–	8	–
47	24856	0x6118	HIGH	Market in which the trip unit is used	95	ETU	Format (95)	2	–

4.5 Data sets for SENTRON WL

Byte offset	Modbus register number			Description	Data point	Source WL	Format	Length (bits)	Scaling
	Dec	Hex	High/Low						
48	24857	0x6119	–	Identification number of circuit breaker	96	ETU	20 x char	160	–
68	24867	0x6123	–	Reserved	–	–	–	48	–
74	24870	0x6126	–	Test date of the circuit breaker	98	ETU	Time	64	–
82	24874	0x612A	LOW	Interrupting class	99	ETU	Format (99)	4	–
83	24874	0x612A	HIGH	Frame size	100	ETU	Format (100)	2	–
84	24875	0x612B	–	Rated voltage (LL) of the circuit breaker	101	ETU	Unsigned int	16	0
86	24876	0x612C	–	External GF CT rating	102	ETU	Unsigned int	16	0
88	24877	0x612D	–	Part number of circuit breaker	103	ETU	Format (103)	160	–
108	24887	0x6137	–	Reserved	–	–	–	144	–
126	24896	0x6140	–	Part number of the trip unit	371	ETU	18 x char	144	–
144	24905	0x6149	LOW	Number of poles of circuit breaker	108	ETU	Format (108)	3	–
145	24905	0x6149	HIGH	Reserved	–	–	–	8	–
146	24906	0x614A	–	Rating plug	377	ETU	Unsigned int	16	0
148	24907	0x614B	–	Reserved	–	–	Unsigned int	16	0
150	24908	0x614C	–	Reserved	–	–	–	400	–
200	24933	0x6165	LOW	Property byte: Part number of the trip unit	–	ETU	PB	8	–
201	24933	0x6165	HIGH	Property byte: Date of manufacture of trip unit	–	ETU	PB	8	–
202	24934	0x6166	LOW	Property byte: Identification number of trip unit	–	ETU	PB	8	–
203	24934	0x6166	HIGH	Property byte: Ground-fault sensing method	–	ETU	PB	8	–
204	24935	0x6167	LOW	Property byte: Neutral CT connected	–	ETU	PB	8	–
205	24935	0x6167	HIGH	Reserved	–	–	–	8	–
206	24936	0x6168	LOW	Property byte: Market in which the trip unit is used	–	ETU	PB	8	–
207	24936	0x6168	HIGH	Property byte: Identification number of circuit breaker	–	ETU	PB	8	–
208	24937	0x6169	LOW	Reserved	–	–	–	8	–

Byte offset	Modbus register number			Description	Data point	Source WL	Format	Length (bits)	Scaling
	Dec	Hex	High/Low						
209	24937	0x6169	HIGH	Property byte: Test date of the circuit breaker	–	ETU	PB	8	–
210	24938	0x616A	LOW	Property byte: Interrupting class	–	ETU	PB	8	–
211	24938	0x616A	HIGH	Property byte: Size	–	ETU	PB	8	–
212	24939	0x616B	LOW	Property byte: Rated voltage (LL) of the circuit breaker	–	ETU	PB	8	–
213	24939	0x616B	HIGH	Property byte: External GF CT rating	–	ETU	PB	8	–
214	24940	0x616C	LOW	Property byte: Part number of the circuit breaker (trip unit)	–	ETU	PB	8	–
215	24940	0x616C	HIGH	Reserved	–	–	–	8	–
216	24941	0x616D	LOW	Property byte: Part number of the trip unit	–	ETU	PB	8	–
217	24941	0x616D	HIGH	Property byte: Number of poles of circuit breaker	–	ETU	PB	8	–
218	24942	0x616E	LOW	Property byte: Rating plug value	–	ETU	PB	8	–
219	24942	0x616E	HIGH	Reserved	–	ETU	PB	8	–
220	24943	0x616F	LOW	Reserved	–	–	–	8	–
221	24943	0x616F		Reserved	–	–	PB	16	–

4.5.18 Data set DS 100: Identification overview

The table below shows the content of data set 100 – Identification overview (length 50 Modbus registers, read only), which contains the identification of the circuit breaker (e.g. test date, manufacturer, device name or family, device class).

Table 4- 36 Content of data set 100

Byte offset	Modbus register number			Description	Data point	Source WL	Format	Length (bits)	Scaling
	Dec	Hex	High/Low						
0	25601	0x6401	–	Header; value 0x00 00 00 00	–	COM35	–	32	–
4	25603	0x6403	–	Test date of the circuit breaker	–	ETU	Time	64	–
12	25607	0x6407	–	Manufacturer (SIEMENS)	–	COM35	20 x char	160	–
32	25617	0x6411	–	Device name (SENTRON WL)	–	COM35	24 x char	192	–
56	25629	0x641D	LOW	Device family (fixed value 0x03)	–	COM35	Hex	8	–
57	25629	0x641D	HIGH	Device bus family (fixed value 0x01)	–	COM35	Hex	8	–
58	25630	0x641E	LOW	Device class 1 = Air circuit breaker 2 = Molded case circuit breaker	–	COM35	Hex	8	–
59	25630	0x641E	HIGH	System (fixed value 0x06)	–	COM35	Hex	8	–
60	25631	0x641F	LOW	Function group: Bit 0.5 for COM35	–	COM35	Hex	8	–
61	25631	0x641F	HIGH	Reserved	–	–	–	8	–
62	25632	0x6420	–	Abbreviated designation (PCB or MCCB)	–	COM35	16 x char	128	–
78	25640	0x6428	–	Hardware version	495	COM35	4 x char	32	–
82	25642	0x642A	–	PROFINET ID number (0x002A0E05)	–	COM35	Hex	32	–
86	25644	0x642C	–	Reserved	–	–	–	16	–
88	25645	0x642D	–	Service number (lower part of circuit breaker identification number)	–	COM35	8 x char	64	–
96	25649	0x6431	–	Firmware version of the COM35-Module	503	COM35	4 x char	32	–

4.5.19 Data set DS 128: Parameters of the metering function and enhanced protection function

The table below shows the content of data set 128 by which the parameters of the metering function and the enhanced protection function can be read out but also modified. It also contains the assignments of the configurable digital output module (length 52 Modbus registers, read and write).

Table 4- 37 Content of data set 128 Modbus register address hex 0x800x (dec 32769 ... 32783)

Byte offset	Modbus register number			Description	Data point	Source WL	Format	Length (bits)	Scaling
	Dec	Hex	High/Low						
0	32769	0x8001	–	Header; value 0x00 00 00 00	–	COM35	–	32	–
4	32771	0x8003	LOW	Voltage transformer primary connection: star/wye or delta	162	Meter. fct.	Format (162)	1	–
5	32771	0x8003	HIGH	Reserved	–	–	–	8	–
6	32772	0x8004	–	Voltage transformer primary rating	164	Meter. fct.	Unsigned int	16	0
8	32773	0x8005	LOW	Voltage transformer secondary rating	165	Meter. fct.	Unsigned char	8	0
9	32773	0x8005	HIGH	Length of period for calculating demand	166	Meter. fct.	Unsigned char	8	0
10	32774	0x8006	LOW	Number of sub-periods for calculating demand	167	Meter. fct.	Unsigned char	8	0
11	32774	0x8006	HIGH	Reserved	–	–	–	8	–
12	32775	0x8007	–	Underflow limit ¹⁾	372	ETU	Unsigned int	16	0
14	32776	0x8008	–	Active power in normal direction	141	Meter. fct.	Unsigned int	16	0
16	32777	0x8009	–	Active power in reverse direction	143	Meter. fct.	Unsigned int	16	0
18	32778	0x800A	LOW	Delay time for active power in normal direction	142	Meter. fct.	Unsigned char	8	0
19	32778	0x800A	HIGH	Delay time for active power in reverse direction	144	Meter. fct.	Unsigned char	8	0
20	32779	0x800B	LOW	Normal direction of incoming supply	145	Meter. fct.	Format (145)	1	–
21	32779	0x800B	HIGH	Direction of phase rotation	146	Meter. fct.	Format (146)	1	–
22	32780	0x800C	–	Underfrequency	147	Meter. fct.	Unsigned int	16	0
24	32781	0x800D	LOW	Delay time for overfrequency	150	Meter. fct.	Unsigned char	8	0
25	32781	0x800D	HIGH	Delay time for underfrequency	148	Meter. fct.	Unsigned char	8	0
26	32782	0x800E	–	Overfrequency	149	Meter. fct.	Unsigned int	16	0

4.5 Data sets for SENTRON WL

Byte offset	Modbus register number			Description	Data point	Source WL	Format	Length (bits)	Scaling
	Dec	Hex	High/Low						
28	32783	0x800F	LOW	THD current	158	Meter. fct.	Unsigned char	8	0
29	32783	0x800F	HIGH	Delay time for THD current	159	Meter. fct.	Unsigned char	8	0

1) Currents below this value are displayed and communicated as 0. Default value = 50 A.

Table 4- 38 Content of data set 128 Modbus register address hex 0x801x (dec 32784 ... 32792)

Byte offset	Modbus register number			Description	Data point	Source WL	Format	Length (bits)	Scaling
	Dec	Hex	High/Low						
30	32784	0x8010	LOW	THD voltage	160	Meter. fct.	Unsigned char	8	0
31	32784	0x8010	HIGH	Delay time for THD voltage	161	Meter. fct.	Unsigned char	8	0
32	32785	0x8011	LOW	Voltage unbalance	151	Meter. fct.	Unsigned char	8	0
33	32785	0x8011	HIGH	Delay time for voltage unbalance	152	Meter. fct.	Unsigned char	8	0
34	32786	0x8012	–	Undervoltage	153	Meter. fct.	Unsigned int	16	0
36	32787	0x8013	–	Overvoltage	155	Meter. fct.	Unsigned int	16	0
38	32788	0x8014	LOW	Delay time for undervoltage	154	Meter. fct.	Unsigned char	8	0
39	32788	0x8014	HIGH	Delay time for overvoltage	156	Meter. fct.	Unsigned char	8	0
40	32789	0x8015	LOW	Reserved	–	–	–	8	–
41	32789	0x8015	HIGH	Current unbalance	139	Meter. fct.	Unsigned char	8	0
42	32790	0x8016	LOW	Delay time for current unbalance	140	Meter. fct.	Unsigned char	8	0
43	32790	0x8016	HIGH	Reserved	–	–	–	8	–
44	32791	0x8017	–	Reserved	–	–	–	16	0
46	32792	0x8018	–	Configurable Digital Output Module Event Configuration	129	Conf. DO	Format (129)	168	–

Table 4- 39 Content of data set 128 Modbus register address hex 0x802x (dec 32802 ... 32815)

Byte offset	Modbus register number			Description	Data point	Source WL	Format	Length (bits)	Scaling
	Dec	Hex	High/Low						
67	32802	0x8022	–	Reserved	–	–	–	24	–
70	32804	0x8024	LOW	Property byte: Voltage transformer primary connection: star/wye or delta	–	Meter. fct.	PB	8	–
71	32804	0x8024	HIGH	Reserved	–	–	–	8	–
72	32805	0x8025	LOW	Property byte: Voltage transformer primary rating	–	Meter. fct.	PB	8	–
73	32805	0x8025	HIGH	Property byte: Voltage transformer secondary rating	–	Meter. fct.	PB	8	–
74	32806	0x8026	LOW	Property byte: Length of period for calculating demand	–	Meter. fct.	PB	8	–
75	32806	0x8026	HIGH	Property byte: Number of sub-periods for calculating demand	–	Meter. fct.	PB	8	–
76	32807	0x8027	LOW	Reserved	–	–	–	8	–
77	32807	0x8027	HIGH	Property byte 2: Underflow limit	–	ETU	PB	8	–
78	32808	0x8028	LOW	Property byte: Active power in normal direction	–	Meter. fct.	PB	8	–
79	32808	0x8028	HIGH	Property byte: Active power in reverse direction	–	Meter. fct.	PB	8	–
80	32809	0x8029	LOW	Property byte: Delay time for active power in normal direction	–	Meter. fct.	PB	8	–
81	32809	0x8029	HIGH	Property byte: Delay time for active power in reverse direction	–	Meter. fct.	PB	8	–
82	32810	0x802A	LOW	Property byte: Normal direction of incoming supply	–	Meter. fct.	PB	8	–
83	32810	0x802A	HIGH	Property byte: Direction of phase rotation	–	Meter. fct.	PB	8	–
84	32811	0x802B	LOW	Property byte: Underfrequency	–	Meter. fct.	PB	8	–
85	32811	0x802B	HIGH	Property byte: Delay time for overfrequency	–	Meter. fct.	PB	8	–
86	32812	0x802C	LOW	Property byte: Delay time for underfrequency	–	Meter. fct.	PB	8	–

4.5 Data sets for SENTRON WL

Byte offset	Modbus register number			Description	Data point	Source WL	Format	Length (bits)	Scaling
	Dec	Hex	High/Low						
87	32812	0x802C	HIGH	Property byte: Overfrequency	–	Meter. fct.	PB	8	–
88	32813	0x802D	LOW	Property byte: THD current	–	Meter. fct.	PB	8	–
89	32813	0x802D	HIGH	Property byte: Delay time for THD current	–	Meter. fct.	PB	8	–
90	32814	0x802E	LOW	Property byte: THD voltage	–	Meter. fct.	PB	8	–
91	32814	0x802E	HIGH	Property byte: Delay time for THD voltage	–	Meter. fct.	PB	8	–
92	32815	0x802F	LOW	Property byte: Voltage unbalance	–	Meter. fct.	PB	8	–
93	32815	0x802F	HIGH	Property byte: Delay time for voltage unbalance	–	Meter. fct.	PB	8	–

Table 4- 40 Content of data set 128 Modbus register address hex 0x803x (dec 32816 ... 32820)

Byte offset	Modbus register number			Description	Data point	Source WL	Format	Length (bits)	Scaling
	Dec	Hex	High/Low						
94	32816	0x8030	LOW	Property byte: Undervoltage	–	Meter. fct.	PB	8	–
95	32816	0x8030	HIGH	Property byte: Overvoltage	–	Meter. fct.	PB	8	–
96	32817	0x8031	LOW	Property byte: Delay time for undervoltage	–	Meter. fct.	PB	8	–
97	32817	0x8031	HIGH	Property byte: Delay time for overvoltage	–	Meter. fct.	PB	8	–
98	32818	0x8032	LOW	Property byte: Reserved	–	Meter. fct.	PB	8	–
99	32818	0x8032	HIGH	Property byte: Current unbalance	–	Meter. fct.	PB	8	–
100	32819	0x8033	LOW	Property byte: Delay time for current unbalance	–	Meter. fct.	PB	8	–
101	32819	0x8033	HIGH	Reserved	–	–	PB	8	–
102	32820	0x8034	LOW	Property byte: Configurable Digital Output Module Event Configuration	–	Conf. DO	PB	8	–

4.5.20 Data set DS 129: Parameters of the protection function and settings for load shed threshold and load pickup

The table below shows the content of data set 129 that contains the parameters of the protection function (e.g. overload pickup, overload/long-time delay, short-circuit pickup, thermal memory, phase loss sensitivity), and the settings for load shed threshold and load pickup.

Table 4- 41 Content of data set 129 Modbus register address hex 0x810x (dec 33025 ... 33039)

Byte offset	Modbus register number			Description	Data point	Source WL	Format	Length (bits)	Scaling
	Dec	Hex	High/Low						
0	33025	0x8101	–	Header; value 0x00 00 00 00	–	COM35	–	32	–
4	33027	0x8103	–	Overload/long-time pickup I_R PS A	333	ETU	Unsigned int	16	0
6	33028	0x8104	–	Neutral overload pickup I_N PS A	334	ETU	Unsigned int	16	0
8	33029	0x8105	–	Overload/long-time delay t_R PS A	335	ETU	Unsigned int	16	–1
10	33030	0x8106	–	Instantaneous short-circuit pickup I_i PS A	336	ETU	Unsigned int	16	1
12	33031	0x8107	–	Short-time delayed pickup I_{sd} PS A	337	ETU	Unsigned int	16	1
14	33032	0x8108	–	Short-time delay t_{sd} PS A	338	ETU	Unsigned int	16	–3
16	33033	0x8109	–	Ground-fault pickup I_g PS A	339	ETU	Unsigned int	16	0
18	33034	0x810A	–	Ground-fault delay t_g PS A	340	ETU	Unsigned int	16	–3
20	33035	0x810B	–	Ground-fault alarm pickup I_{g2} PS A	341	ETU	Unsigned int	16	0
22	33036	0x810C	–	Ground-fault alarm delay t_{g2} PS A	342	ETU	Unsigned int	16	–3
24	33037	0x810D	LOW	I^2t characteristic for delayed short-circuit protection PS A	343	ETU	Format (343)	1	–
25	33037	0x810D	HIGH	I^2t characteristic for ground-fault protection PS A	344	ETU	Format (344)	1	–
26	33038	0x810E	LOW	Overload/long-time delay characteristic (I^2t or I^4t) PS A	345	ETU	Format (345)	1	–
27	33038	0x810E	HIGH	Overload/long-time thermal memory on/off PS A	346	ETU	Format (346)	1	–
28	33039	0x810F	LOW	Phase loss sensitivity PS A	347	ETU	Format (347)	1	–
29	33039	0x810F	HIGH	Reserved	–	–	–	8	–

4.5 Data sets for SENTRON WL

Table 4- 42 Content of data set 129 Modbus register address hex 0x811x (dec 33040 ... 33055)

Byte offset	Modbus register number			Description	Data point	Source WL	Format	Length (bits)	Scaling
	Dec	Hex	High/Low						
30	33040	0x8110	–	Thermal time constant PS A	348	ETU	Unsigned int	16	0
32	33041	0x8111	–	Overload/long-time pickup I_R PS B	349	ETU	Unsigned int	16	0
34	33042	0x8112	–	Neutral overload pickup I_N PS B	350	ETU	Unsigned int	16	0
36	33043	0x8113	–	Overload/long-time delay t_R PS B	351	ETU	Unsigned int	16	–1
38	33044	0x8114	–	Instantaneous short-circuit pickup I_i PS B	352	ETU	Unsigned int	16	1
40	33045	0x8115	–	Short-time delayed pickup I_{sd} PS B	353	ETU	Unsigned int	16	1
42	33046	0x8116	–	Short-time delay t_{sd} PS B	354	ETU	Unsigned int	16	–3
44	33047	0x8117	–	Ground-fault pickup I_g PS B	355	ETU	Unsigned int	16	0
46	33048	0x8118	–	Ground-fault delay t_g PS B	356	ETU	Unsigned int	16	–3
48	33049	0x8119	–	Ground-fault alarm I_{g2} PS B	357	ETU	Unsigned int	16	0
50	33050	0x811A	–	Ground-fault alarm delay t_{g2} PS B	358	ETU	Unsigned int	16	–3
52	33051	0x811B	LOW	Short-time delay characteristic (I^2t or definite time) PS B	359	ETU	Format (343)	1	–
53	33051	0x811B	HIGH	I^2t characteristic for ground-fault protection PS B	360	ETU	Format (344)	1	–
54	33052	0x811C	LOW	Overload/long-time delay characteristic (I^2t or I^4t) PS B	361	ETU	Format (345)	1	–
55	33052	0x811C	HIGH	Overload/long-time thermal memory on/off PS B	362	ETU	Format (346)	1	–
56	33053	0x811D	LOW	Phase loss sensitivity PS B	363	ETU	Format (347)	1	–
57	33053	0x811D	HIGH	Reserved	–	–	–	8	–
58	33054	0x811E	–	Thermal time constant PS B	364	ETU	Unsigned int	16	0
60	33055	0x811F	–	Load shed threshold	367	ETU	Unsigned int	16	0

Table 4- 43 Content of data set 129 Modbus register address hex 0x812x (dec 33056 ... 33061)

Byte offset	Modbus register number			Description	Data point	Source WL	Format	Length (bits)	Scaling
	Dec	Hex	High/Low						
62	33056	0x8120	–	Load pickup level	368	ETU	Unsigned int	16	0
64	33057	0x8121	LOW	Delay time for load shed/pickup	366	ETU	Unsigned char	8	0
65	33057	0x8121	HIGH	Active parameter set	370	ETU	Format (370)	1	–
66	33058	0x8122	–	Reserved	–	–	–	16	0
68	33059	0x8123	LOW	Reserved	–	–	–	8	0
69	33059	0x8123	HIGH	Ground-fault sensing method	410	ETU	Format (410)	2	–
70	33060	0x8124	–	External GF CT rating	102	ETU	Unsigned int	16	0
72	33061	0x8125	–	Reserved	331	–	–	208	–

Table 4- 44 Content of data set 129 Modbus register address hex 0x813x (dec 33074 ... 33087)

Byte offset	Modbus register number			Description	Data point	Source WL	Format	Length (bits)	Scaling
	Dec	Hex	High/Low						
98	33074	0x8132	LOW	Property byte: External GF CT rating	333	ETU	PB	8	–
99	33074	0x8132	HIGH	Reserved	–	–	–	8	–
100	33075	0x8133	LOW	Property byte: Overload/long-time pickup I_R PS A	335	ETU	PB	8	–
101	33075	0x8133	HIGH	Property byte: Neutral overload pickup I_N PS A	336	ETU	PB	8	–
102	33076	0x8134	LOW	Property byte: Overload/long-time delay t_R PS A	337	ETU	PB	8	–
103	33076	0x8134	HIGH	Property byte: Instantaneous short-circuit pickup I_i PS A	338	ETU	PB	8	–
104	33077	0x8135	LOW	Property byte: Short-time delayed pickup I_{sd} PS A	339	ETU	PB	8	–
105	33077	0x8135	HIGH	Property byte: Short-time delay t_{sd} PS A	340	ETU	PB	8	–
106	33078	0x8136	LOW	Property byte: Ground-fault alarm pickup I_g PS A	341	ETU	PB	8	–
107	33078	0x8136	HIGH	Property byte: Ground-fault delay t_g PS A	342	ETU	PB	8	–

4.5 Data sets for SENTRON WL

Byte offset	Modbus register number			Description	Data point	Source WL	Format	Length (bits)	Scaling
	Dec	Hex	High/Low						
108	33079	0x8137	LOW	Property byte: Ground-fault alarm pickup I_{g2} PS A	343	ETU	PB	8	–
109	33079	0x8137	HIGH	Property byte: Ground-fault alarm delay t_{g2} PS A	344	ETU	PB	8	–
110	33080	0x8138	LOW	Property byte: I^2t characteristic for delayed short-circuit protection PS A	345	ETU	PB	8	–
111	33080	0x8138	HIGH	Property byte: I^2t characteristic for ground-fault protection PS A	346	ETU	PB	8	–
112	33081	0x8139	LOW	Property byte: Overload/long-time delay characteristic (I^2t or I^4t) PS A	347	ETU	PB	8	–
113	33081	0x8139	HIGH	Property byte: Overload/long-time thermal memory on/off PS A	348	ETU	PB	8	–
114	33082	0x813A	LOW	Property byte: Phase loss sensitivity PS A	349	ETU	PB	8	–
115	33082	0x813A	HIGH	Property byte: Thermal time constant PS A	350	ETU	PB	8	–
116	33083	0x813B	LOW	Property byte: Overload/long-time pickup I_R PS B	351	ETU	PB	8	–
117	33083	0x813B	HIGH	Property byte: Neutral overload pickup I_N PS B	352	ETU	PB	8	–
118	33084	0x813C	LOW	Property byte: Overload/long-time delay t_R PS B	353	ETU	PB	8	–
119	33084	0x813C	HIGH	Property byte: Instantaneous short-circuit pickup I_i PS B	354	ETU	PB	8	–
120	33085	0x813D	LOW	Property byte: Short-time delayed pickup I_{sd} PS B	355	ETU	PB	8	–
121	33085	0x813D	HIGH	Property byte: Short-time delay t_{sd} PS B	356	ETU	PB	8	–
122	33086	0x813E	LOW	Property byte: Ground-fault pickup I_g PS B	357	ETU	PB	8	–
123	33086	0x813E	HIGH	Property byte: Ground-fault delay t_g PS B	358	ETU	PB	8	–

Byte offset	Modbus register number			Description	Data point	Source WL	Format	Length (bits)	Scaling
	Dec	Hex	High/Low						
124	33087	0x813F	LOW	Property byte: Ground-fault alarm pickup I_{g2} PS B	359	ETU	PB	8	–
125	33087	0x813F	HIGH	Property byte: Ground-fault alarm delay t_{g2} PS B	360	ETU	PB	8	–

Table 4- 45 Content of data set 129 Modbus register address hex 0x814x (dec 33088 ... 33094)

Byte offset	Modbus register number			Description	Data point	Source WL	Format	Length (bits)	Scaling
	Dec	Hex	High/Low						
126	33088	0x8140	LOW	Property byte: Short-time delay characteristic (I^2t or definite time) PS B	361	ETU	PB	8	–
127	33088	0x8140	HIGH	Property byte: I^2t characteristic for ground-fault protection PS B	362	ETU	PB	8	–
128	33089	0x8141	LOW	Property byte: Overload/long-time delay characteristic (I^2t or I^4t) PS B	363	ETU	PB	8	–
129	33089	0x8141	HIGH	Property byte: Overload/long-time thermal memory on/off PS B	364	ETU	PB	8	–
130	33090	0x8142	LOW	Property byte: Phase loss sensitivity PS B	367	ETU	PB	8	–
131	33090	0x8142	HIGH	Property byte: Thermal time constant PS B	368	ETU	PB	8	–
132	33091	0x8143	LOW	Property byte: Load shed threshold	366	ETU	PB	8	–
133	33091	0x8143	HIGH	Property byte: Load pickup level	370	ETU	PB	8	–
134	33092	0x8144	LOW	Property byte: Delay time for load shed/pickup	365	ETU	PB	8	–
135	33092	0x8144	HIGH	Property byte: Active parameter set	421	–	PB	8	–
136	33093	0x8145	–	Reserved	–	–	–	16	–
138	33094	0x8146	LOW	Property byte: Overload/long-time delay	331	–	PB	8	–

4.5.21 Data set DS 130: Parameters for the alarm setpoint values

The table below shows the content of the data set 130, in which the parameters for generating threshold alarms can be read out and modified (length 74 Modbus registers, read and write).

Table 4- 46 Content of data set 130 Modbus register address hex 0x820x (dec 33281 ... 33295)

Byte offset	Modbus register number			Description	Data point	Source WL	Format	Length (bits)	Scaling
	Dec	Hex	High/Low						
0	33281	0x8201	–	Header; value 0x00 00 00 00	–	COM35	–	32	–
4	33283	0x8203	–	Active power in normal direction	283	Meter. fct.	Unsigned int	16	0
6	33284	0x8204	–	Active power in reverse direction	285	Meter. fct.	Unsigned int	16	0
8	33285	0x8205	–	Power factor, capacitive	287	Meter. fct.	Signed int	16	–3
10	33286	0x8206	–	Power factor, inductive	289	Meter. fct.	Signed int	16	–3
12	33287	0x8207	LOW	Delay time for active power in normal direction	284	Meter. fct.	Unsigned char	8	0
13	33287	0x8207	HIGH	Delay time for active power in reverse direction	286	Meter. fct.	Unsigned char	8	0
14	33288	0x8208	LOW	Delay time for power factor, capacitive	288	Meter. fct.	Unsigned char	8	0
15	33288	0x8208	HIGH	Delay time for power factor, inductive	290	Meter. fct.	Unsigned char	8	0
16	33289	0x8209	LOW	Overfrequency	303	Meter. fct.	Unsigned char	8	0
17	33289	0x8209	HIGH	Delay time for overfrequency	304	Meter. fct.	Unsigned char	8	0
18	33290	0x820A	LOW	Underfrequency	305	Meter. fct.	Unsigned char	8	0
19	33290	0x820A	HIGH	Delay time for underfrequency	306	Meter. fct.	Unsigned char	8	0
20	33291	0x820B	LOW	THD current	319	Meter. fct.	Unsigned char	8	0
21	33291	0x820B	HIGH	Delay time for THD current	320	Meter. fct.	Unsigned char	8	0
22	33292	0x820C	LOW	THD voltage	321	Meter. fct.	Unsigned char	8	0
23	33292	0x820C	HIGH	Delay time for THD voltage	322	Meter. fct.	Unsigned char	8	0
24	33293	0x820D	–	Crest factor	323	Meter. fct.	Unsigned int	16	–2

Byte offset	Modbus register number			Description	Data point	Source WL	Format	Length (bits)	Scaling
	Dec	Hex	High/Low						
26	33294	0x820E	–	Form factor	325	Meter. fct.	Unsigned int	16	–2
28	33295	0x820F	LOW	Delay time for crest factor	324	Meter. fct.	Unsigned char	8	0
29	33295	0x820F	HIGH	Delay time for the form factor	326	Meter. fct.	Unsigned char	8	0

Table 4- 47 Content of data set 130 Modbus register address hex 0x821x (dec 33296 ... 33311)

Byte offset	Modbus register number			Description	Data point	Source WL	Format	Length (bits)	Scaling
	Dec	Hex	High/Low						
30	33296	0x8210	–	Active power demand	291	Meter. fct.	Unsigned int	16	0
32	33297	0x8211	–	Apparent power demand	293	Meter. fct.	Unsigned int	16	0
34	33298	0x8212	LOW	Delay time active power demand	292	Meter. fct.	Unsigned char	8	0
35	33298	0x8212	HIGH	Delay time apparent power demand	294	Meter. fct.	Unsigned char	8	0
36	33299	0x8213	–	Reactive power demand	295	Meter. fct.	Unsigned int	16	0
38	33300	0x8214	–	Reactive power in normal direction	297	Meter. fct.	Unsigned int	16	0
40	33301	0x8215	LOW	Delay time reactive power demand	296	Meter. fct.	Unsigned char	8	0
41	33301	0x8215	HIGH	Delay time for reactive power in normal direction	298	Meter. fct.	Unsigned char	8	0
42	33302	0x8216	–	Reactive power in reverse direction	299	Meter. fct.	Unsigned int	16	0
44	33303	0x8217	–	Apparent power	301	Meter. fct.	Unsigned int	16	0
46	33304	0x8218	LOW	Delay time for reactive power in reverse direction	300	Meter. fct.	Unsigned char	8	0
47	33304	0x8218	HIGH	Delay time for apparent power	302	Meter. fct.	Unsigned char	8	0
48	33305	0x8219	–	Overcurrent	267	Meter. fct.	Unsigned int	16	0
50	33306	0x821A	–	Ground current	269	Meter. fct.	Unsigned int	16	0
52	33307	0x821B	–	Overcurrent in neutral conductor	271	Meter. fct.	Unsigned int	16	0
54	33308	0x821C	–	Current demand	275	Meter. fct.	Unsigned int	16	0

4.5 Data sets for SENTRON WL

Byte offset	Modbus register number			Description	Data point	Source WL	Format	Length (bits)	Scaling
	Dec	Hex	High/Low						
56	33309	0x821D	LOW	Delay time for overcurrent	268	Meter. fct.	Unsigned char	8	0
57	33309	0x821D	HIGH	Delay time of ground current	270	Meter. fct.	Unsigned char	8	0
58	33310	0x821E	LOW	Delay time for overcurrent in neutral conductor	272	Meter. fct.	Unsigned char	8	0
59	33310	0x821E	HIGH	Phase unbalance current	273	Meter. fct.	Unsigned char	8	0
60	33311	0x821F	LOW	Delay time for current phase unbalance	274	Meter. fct.	Unsigned char	8	0
61	33311	0x821F	HIGH	Delay time current demand	276	Meter. fct.	Unsigned char	8	0

Table 4- 48 Content of data set 130 Modbus register address hex 0x822x (dec 33312 ... 33316)

Byte offset	Modbus register number			Description	Data point	Source WL	Format	Length (bits)	Scaling
	Dec	Hex	High/Low						
62	33312	0x8220	–	Undervoltage	277	Meter. fct.	Unsigned int	16	0
64	33313	0x8221	LOW	Delay time for undervoltage	278	Meter. fct.	Unsigned char	8	0
65	33313	0x8221	HIGH	Phase unbalance voltage	279	Meter. fct.	Unsigned char	8	0
66	33314	0x8222	LOW	Delay time for voltage phase unbalance	280	Meter. fct.	Unsigned char	8	0
67	33314	0x8222	HIGH	Reserved	–	–	–	8	–
68	33315	0x8223	–	Overvoltage	281	Meter. fct.	Unsigned int	16	0
70	33316	0x8224	LOW	Delay time for overvoltage	282	Meter. fct.	Unsigned char	8	0
71	33316	0x8224	–	Reserved	–	–	–	232	–

Table 4- 49 Content of data set 130 Modbus register address hex 0x823x (dec 33331 ... 33343)

Byte offset	Modbus register number			Description	Data point	Source WL	Format	Length (bits)	Scaling
	Dec	Hex	High/Low						
100	33331	0x8233	LOW	Property byte: Active power in normal direction	–	Meter. fct.	PB	8	–
101	33331	0x8233	HIGH	Property byte: Active power in reverse direction	–	Meter. fct.	PB	8	–

Byte offset	Modbus register number			Description	Data point	Source WL	Format	Length (bits)	Scaling
	Dec	Hex	High/Low						
102	33332	0x8234	LOW	Property byte: Power factor, capacitive	–	Meter. fct.	PB	8	–
103	33332	0x8234	HIGH	Property byte: Power factor, inductive	–	Meter. fct.	PB	8	–
104	33333	0x8235	LOW	Property byte: Delay time for active power in normal direction	–	Meter. fct.	PB	8	–
105	33333	0x8235	HIGH	Property byte: Delay time for active power in reverse direction	–	Meter. fct.	PB	8	–
106	33334	0x8236	LOW	Property byte: Delay time for power factor, capacitive	–	Meter. fct.	PB	8	–
107	33334	0x8236	HIGH	Property byte: Delay time for power factor, inductive	–	Meter. fct.	PB	8	–
108	33335	0x8237	LOW	Property byte: Overfrequency	–	Meter. fct.	PB	8	–
109	33335	0x8237	HIGH	Property byte: Delay time for overfrequency	–	Meter. fct.	PB	8	–
110	33336	0x8238	LOW	Property byte: Underfrequency	–	Meter. fct.	PB	8	–
111	33336	0x8238	HIGH	Property byte: Delay time for underfrequency	–	Meter. fct.	PB	8	–
112	33337	0x8239	LOW	Property byte: THD current	–	Meter. fct.	PB	8	–
113	33337	0x8239	HIGH	Property byte: Delay time for THD current	–	Meter. fct.	PB	8	–
114	33338	0x823A	LOW	Property byte: THD voltage	–	Meter. fct.	PB	8	–
115	33338	0x823A	HIGH	Property byte: Delay time for THD voltage	–	Meter. fct.	PB	8	–
116	33339	0x823B	LOW	Property byte: Crest factor	–	Meter. fct.	PB	8	–
117	33339	0x823B	HIGH	Property byte: Form factor	–	Meter. fct.	PB	8	–
118	33340	0x823C	LOW	Property byte: Delay time for crest factor	–	Meter. fct.	PB	8	–
119	33340	0x823C	HIGH	Property byte: Delay time for the form factor	–	Meter. fct.	PB	8	–
120	33341	0x823D	LOW	Property byte: Active power demand	–	Meter. fct.	PB	8	–
121	33341	0x823D	HIGH	Property byte: Apparent power demand	–	Meter. fct.	PB	8	–

4.5 Data sets for SENTRON WL

Byte offset	Modbus register number			Description	Data point	Source WL	Format	Length (bits)	Scaling
	Dec	Hex	High/Low						
122	33342	0x823E	LOW	Property byte: Delay time active power demand	–	Meter. fct.	PB	8	–
123	33342	0x823E	HIGH	Property byte: Delay time apparent power demand	–	Meter. fct.	PB	8	–
124	33343	0x823F	LOW	Property byte: Reactive power demand	–	Meter. fct.	PB	8	–
125	33343	0x823F	HIGH	Property byte: Reactive power in normal direction	–	Meter. fct.	PB	8	–

Table 4- 50 Content of data set 130 Modbus register address hex 0x824x (dec 33344 ... 33354)

Byte offset	Modbus register number			Description	Data point	Source WL	Format	Length (bits)	Scaling
	Dec	Hex	High/Low						
126	33344	0x8240	LOW	Property byte: Delay time reactive power demand	–	Meter. fct.	PB	8	–
127	33344	0x8240	HIGH	Property byte: Delay time for reactive power in normal direction	–	Meter. fct.	PB	8	–
128	33345	0x8241	LOW	Property byte: Reactive power in reverse direction	–	Meter. fct.	PB	8	–
129	33345	0x8241	HIGH	Property byte: Apparent power	–	Meter. fct.	PB	8	–
130	33346	0x8242	LOW	Property byte: Delay time for reactive power in reverse direction	–	Meter. fct.	PB	8	–
131	33346	0x8242	HIGH	Property byte: Delay time for apparent power	–	Meter. fct.	PB	8	–
132	33347	0x8243	LOW	Property byte: Overcurrent	–	Meter. fct.	PB	8	–
133	33347	0x8243	HIGH	Property byte: Ground current	–	Meter. fct.	PB	8	–
134	33348	0x8244	LOW	Property byte: Overcurrent in neutral conductor	–	Meter. fct.	PB	8	–
135	33348	0x8244	HIGH	Property byte: Current demand	–	Meter. fct.	PB	8	–
136	33349	0x8245	LOW	Property byte: Delay time for overcurrent	–	Meter. fct.	PB	8	–
137	33349	0x8245	HIGH	Property byte: Delay time of ground current	–	Meter. fct.	PB	8	–

Byte offset	Modbus register number			Description	Data point	Source WL	Format	Length (bits)	Scaling
	Dec	Hex	High/Low						
138	33350	0x8246	LOW	Property byte: Delay time for overcurrent in neutral conductor	–	Meter. fct.	PB	8	–
139	33350	0x8246	HIGH	Property byte: Phase unbalance current	–	Meter. fct.	PB	8	–
140	33351	0x8247	LOW	Property byte: Delay time for current phase unbalance	–	Meter. fct.	PB	8	–
141	33351	0x8247	HIGH	Property byte: Delay time current demand	–	Meter. fct.	PB	8	–
142	33352	0x8248	LOW	Property byte: Undervoltage	–	Meter. fct.	PB	8	–
143	33352	0x8248	HIGH	Property byte: Delay time for undervoltage	–	Meter. fct.	PB	8	–
144	33353	0x8249	LOW	Property byte: Phase unbalance voltage	–	Meter. fct.	PB	8	–
145	33353	0x8249	HIGH	Property byte: Delay time for voltage phase unbalance	–	Meter. fct.	PB	8	–
146	33354	0x824A	LOW	Property byte: Overvoltage	–	Meter. fct.	PB	8	–
147	33354	0x824A	HIGH	Property byte: Delay time for overvoltage	–	Meter. fct.	PB	8	–

4.5.22 Data set DS 131: Parameters to activate/deactivate extended protective functions and alarm setpoint functions

The table below shows the content of data set 131 in whose property bytes the parameters of the protection function, the enhanced protection function, and the threshold parameters can be switched on and switched off (length 35 Modbus registers, read and write).

Table 4- 51 Content of data set 131 Modbus register address hex 0x830x (dec 33537 to 33551)

Byte offset	Modbus register number			Description	Data point	Source WL	Format	Length (bits)	Scaling
	Dec	Hex	High/Low						
0	33537	0x8301	–	Header; value 0x00 00 00 00	–	COM35	–	32	–
4	33539	0x8303	LOW	Property byte: Overload/long-time pickup I_R PS A	–	ETU	PB	8	–
5	33539	0x8303	HIGH	Property byte: Neutral overload pickup I_N PS A	–	ETU	PB	8	–

4.5 Data sets for SENTRON WL

Byte offset	Modbus register number			Description	Data point	Source WL	Format	Length (bits)	Scaling
	Dec	Hex	High/Low						
6	33540	0x8304	LOW	Property byte: Instantaneous short-circuit pickup I_i PS A	–	ETU	PB	8	–
7	33540	0x8304	HIGH	Property byte: Short-time delayed pickup I_{sd} PS A	–	ETU	PB	8	–
8	33541	0x8305	LOW	Property byte: Ground-fault alarm pickup I_g PS A	–	ETU	PB	8	–
9	33541	0x8305	HIGH	Property byte: Ground-fault alarm pickup I_{g2} PS A	–	ETU	PB	8	–
10	33542	0x8306	LOW	Property byte: Overload/long-time pickup I_R PS B	–	ETU	PB	8	–
11	33542	0x8306	HIGH	Property byte: Neutral overload pickup I_N PS B	–	ETU	PB	8	–
12	33543	0x8307	LOW	Property byte: Instantaneous short-circuit pickup I_i PS B	–	ETU	PB	8	–
13	33543	0x8307	HIGH	Property byte: Short-time delayed pickup I_{sd} PS B	–	ETU	PB	8	–
14	33544	0x8308	LOW	Property byte: Ground-fault pickup I_g PS B	–	ETU	PB	8	–
15	33544	0x8308	HIGH	Property byte: Ground-fault alarm pickup I_{g2} PS B	–	ETU	PB	8	–
16	33545	0x8309	LOW	Property byte: Active power in normal direction	–	Meter. fct.	PB	8	–
17	33545	0x8309	HIGH	Property byte: Active power in reverse direction	–	Meter. fct.	PB	8	–
18	33546	0x830A	LOW	Property byte: Direction of phase rotation	–	Meter. fct.	PB	8	–
19	33546	0x830A	HIGH	Property byte: Underfrequency	–	Meter. fct.	PB	8	–
20	33547	0x830B	LOW	Property byte: Overfrequency	–	Meter. fct.	PB	8	–
21	33547	0x830B	HIGH	Property byte: THD current	–	Meter. fct.	PB	8	–
22	33548	0x830C	LOW	Property byte: THD current	–	Meter. fct.	PB	8	–
23	33548	0x830C	HIGH	Property byte: Voltage unbalance	–	Meter. fct.	PB	8	–

Byte offset	Modbus register number			Description	Data point	Source WL	Format	Length (bits)	Scaling
	Dec	Hex	High/Low						
24	33549	0x830D	LOW	Property byte: Undervoltage	–	Meter. fct.	PB	8	–
25	33549	0x830D	HIGH	Property byte: Overvoltage	–	Meter. fct.	PB	8	–
26	33550	0x830E	LOW	Property byte: Current unbalance	–	Meter. fct.	PB	8	–
27	33550	0x830E	HIGH	Property byte: Active power in normal direction	–	Meter. fct.	PB	8	–
28	33551	0x830F	LOW	Property byte: Active power in reverse direction	–	Meter. fct.	PB	8	–
29	33551	0x830F	HIGH	Property byte: Power factor, capacitive	–	Meter. fct.	PB	8	–

Table 4- 52 Content of data set 131 Modbus register address hex 0x831x (dec 33552 to 33551)

Byte offset	Modbus register number			Description	Data point	Source WL	Format	Length (bits)	Scaling
	Dec	Hex	High/Low						
30	33552	0x8310	LOW	Property byte: Power factor, inductive	–	Meter. fct.	PB	8	–
31	33552	0x8310	HIGH	Property byte: Overfrequency	–	Meter. fct.	PB	8	–
32	33553	0x8311	LOW	Property byte: Underfrequency	–	Meter. fct.	PB	8	–
33	33553	0x8311	HIGH	Property byte: THD current	–	Meter. fct.	PB	8	–
34	33554	0x8312	LOW	Property byte: THD voltage	–	Meter. fct.	PB	8	–
35	33554	0x8312	HIGH	Property byte: Crest factor	–	Meter. fct.	PB	8	–
36	33555	0x8313	LOW	Property byte: Form factor	–	Meter. fct.	PB	8	–
37	33555	0x8313	HIGH	Property byte: Active power demand	–	Meter. fct.	PB	8	–
38	33556	0x8314	LOW	Property byte: Apparent power demand	–	Meter. fct.	PB	8	–
39	33556	0x8314	HIGH	Property byte: Reactive power demand	–	Meter. fct.	PB	8	–
40	33557	0x8315	LOW	Property byte: Reactive power in normal direction	–	Meter. fct.	PB	8	–
41	33557	0x8315	HIGH	Property byte: Reactive power in reverse direction	–	Meter. fct.	PB	8	–

4.5 Data sets for SENTRON WL

Byte offset	Modbus register number			Description	Data point	Source WL	Format	Length (bits)	Scaling
	Dec	Hex	High/Low						
42	33558	0x8316	LOW	Property byte: Apparent power	–	Meter. fct.	PB	8	–
43	33558	0x8316	HIGH	Property byte: Overcurrent	–	Meter. fct.	PB	8	–
44	33559	0x8317	LOW	Property byte: Ground current	–	Meter. fct.	PB	8	–
45	33559	0x8317	HIGH	Property byte: Overcurrent in neutral conductor	–	Meter. fct.	PB	8	–
46	33560	0x8318	LOW	Property byte: Current demand	–	Meter. fct.	PB	8	–
47	33560	0x8318	HIGH	Property byte: Phase unbalance current	–	Meter. fct.	PB	8	–
48	33561	0x8319	LOW	Property byte: Undervoltage	–	Meter. fct.	PB	8	–
49	33561	0x8319	HIGH	Property byte: Phase unbalance voltage	–	Meter. fct.	PB	8	–
50	33562	0x831A	LOW	Property byte: Overvoltage	–	Meter. fct.	PB	8	–
51	33562	0x831A	HIGH	Reserved	–	–	–	8	–
52	33563	0x831B	LOW	Property byte: Overload/long-time thermal memory on/off PS A	–	ETU	PB	8	–
53	33563	0x831B	HIGH	Reserved	–	–	–	8	–
54	33564	0x831C	LOW	Property byte: Neutral CT connected	–	ETU	PB	8	–
55	33564	0x831C	–	Reserved	–	–	–	120	–

4.5.23 Data set DS 160: Parameters for communication

The following table shows data set 160, parameters for communication (length 39 Modbus registers, read and write) in which the parameters for reading out and setting the communication are stored.

Table 4- 53 Content of data set 160

Byte offset	Modbus register number			Description	Data point	Source WL	Format	Length (bits)	Scaling
	Dec	Hex	High/Low						
0	40961	0xA001	–	Header; value 0x00 00 00 00	–	COM35	–	32	–
4	40963	0xA003	LOW	Reserved	–	–	–	16	–
6	40964	0xA004	LOW	Basic type of Modbus TCP data transfer	6	COM35	Hex	2	–
7	40964	0xA004	HIGH	Reserved	–	–	–	8	–
8	40965	0xA005	–	Data in the cyclic profile of Modbus TCP	7	COM35	Format (7)	224	–
36	40979	0xA013	–	Reserved	–	–	–	48	–
47	40985	0xA019	–	Reserved	–	–	–	200	–
72	40997	0xA025	LOW	Property byte: Basic type of Modbus TCP data transfer	6	COM35	PB	8	–
73	40997	0xA025	HIGH	Reserved	–	–	–	8	–
74	40998	0xA026	LOW	Property byte: Data in the cyclic profile of Modbus TCP	7	COM35	PB	8	–
75	40998	0xA026	HIGH	Reserved	–	–	–	8	–

4.5.24 Data set DS 161: Parameters for communication

The following table shows the content of data set 161, in which the parameters for reading out and setting the communication of the COM35 are stored (length 82 Modbus registers, read and write).

Table 4- 54 Content of data set 161

Byte offset	Modbus register number			Description	Data point	Source WL	Format	Length (bits)	Scaling
	Dec	Hex	High/Low						
0	41217	0xA101	–	Header; value 0x00 00 00 00	–	COM35	–	32	–
4	41219	0xA103	–	Reserved	–	–	–	16	–
6	41220	0xA104	–	Structure for IPv4 device address, network mask and gateway of the COM35	476	COM35	Format (476)	96	–
18	41226	0xA10A	–	SNTP server IPv4 device address	479	COM35	Unsigned long	32	–
22	41228	0xA10C	–	SNTP operating mode	480	COM35	–	16	–
24	41229	0xA10D	–	SNTP port	481	COM35	Unsigned int	16	–
26	41230	0xA10E	–	Modbus TCP port	482	COM35	Unsigned int	16	–
28	41231	0xA10F	–	Switching IP filters on/off	486	COM35	–	16	–
30	41232	0xA110	–	COM35 MAC address	488	COM35	–	48	–
36	41235	0xA113	–	COM35 switch port 1 MAC address	489	–	–	48	–
42	41238	0xA116	–	COM35 switch port 2 MAC address	490	COM35	–	48	–
48	41241	0xA119	–	Activate device identification	522	COM35	–	16	–
50	41242	0xA11A	–	Controlling the inputs/outputs of the COM35	478	COM35	Format (478)	16	–
52	41243	0xA11B	–	COM35 firmware version	492	COM35	–	72	–
61	41247	0xA11F	HIGH	Reserved	–	–	–	704	–
149	41291	0xA14B	HIGH	Property byte: Structure for IPv4 device address, network mask and gateway of the COM35	–	COM35	PB	8	–
150	41292	0xA14C	LOW	Property byte: SNTP server IPv4 address	–	COM35	PB	8	–
151	41292	0xA14C	HIGH	Property byte: SNTP operating mode	–	COM35	PB	8	–

Byte offset	Modbus register number			Description	Data point	Source WL	Format	Length (bits)	Scaling
	Dec	Hex	High/Low						
152	41293	0xA14D	LOW	Property byte: SNTP port	–	COM35	PB	8	–
153	41293	0xA14D	HIGH	Property byte: Modbus TCP port	–	COM35	PB	8	–
154	41294	0xA14E	LOW	Property byte: Switching IP filters on/off	–	COM35	PB	8	–
155	41294	0xA14E	HIGH	Property byte: COM35 MAC address	–	COM35	PB	8	–
156	41295	0xA14F	LOW	Property byte: COM35 switch port 1 MAC address	–	COM35	PB	8	–
157	41295	0xA14F	HIGH	Property byte: COM35 switch port 2 MAC address	–	COM35	PB	8	–
158	41296	0xA150	LOW	Property byte: Activate device identification	–	COM35	PB	8	–
159	41296	0xA150	HIGH	Property byte: Controlling the inputs and outputs of the COM35	–	COM35	PB	8	–
160	41297	0xA151	LOW	Property byte: COM35 firmware version	–	COM35	PB	8	–
161	41297	0xA151	HIGH	Reserved	–	–	–	24	–

4.5.25 Data set DS 162: Device configuration

The table below shows the content of data set 162 that contains the device configuration. The circuit breaker currently connected can be read out in this data set (length 38 Modbus registers, read only).

Table 4- 55 Content of data set 162

Byte offset	Modbus register number			Description	Data point	Source WL	Format	Length (bits)	Scaling
	Dec	Hex	High/Low						
0	41473	0xA201	–	Header; value 0x00 00 00 00	–	COM35	–	32	–
4	41475	0xA203	–	ID number of the COM35	91	COM35	16 x char	128	–
20	41483	0xA20B	–	Part number of circuit breaker	103	ETU	Format (103)	160	–
40	41493	0xA215	LOW	Type (metering function, metering function PLUS)	138	Meter. fct.	Format (138)	8	–
41	41493	0xA215	HIGH	Type of trip unit	412	ETU	Format (412)	5	–
42	41494	0xA216	–	Reserved	–	–	–	224	–
70	41508	0xA224	LOW	Property byte: ID number of the COM35	–	COM35	PB	8	–
71	41508	0xA224	HIGH	Property byte: Part number of circuit breaker	–	ETU	PB	8	–
72	41509	0xA225	LOW	Property byte: Type (metering function, metering function PLUS)	–	Meter. fct.	PB	8	–
73	41509	0xA225	HIGH	Property byte: Type of trip unit	–	ETU	PB	8	–
74	41510	0xA226	LOW	Reserved	–	–	–	8	–

4.5.26 Data set DS 163: Profinet device name

The following table contains the data set DS 163: Profinet device name:

Table 4- 56 Content of data set 163

Byte offset	Modbus register number			Description	Data point	Source WL	Format	Length (bits)	Scaling
	Dec	Hex	High/Low						
0	41729	0xA301	–	Header; value 0x00 00 00 00	–	COM35	–	32	–
4	41731	0xA303	–	PROFINET device name	509	COM35	–	1920	–
244	41751	0xA37B	LOW	Property byte: PROFINET device name	509	COM35	–	8	–

4.5.27 Data set DS 165: Identification comment

The table below shows the content of data set 165 in which user-specific texts such as comments, plant identifier, date and author can be stored in the SENTRON circuit breaker (length 97 Modbus registers, read and write).

Table 4- 57 Content of data set 165

Byte offset	Modbus register number			Description	Data point	Source WL	Format	Length (bits)	Scaling
	Dec	Hex	High/Low						
0	42241	0xA501	–	Header; value 0x00 00 00 00	–	COM35	–	32	–
4	42243	0xA503	–	User text (freely editable)	20	COM35	64 x char	512	–
68	42275	0xA523	–	Plant identifier (freely editable)	21	COM35	64 x char	512	–
132	42307	0xA543	–	Date (freely editable)	22	COM35	Time	64	–
140	42311	0xA547	–	Author (freely editable)	23	COM35	30 x char	240	–
170	42326	0xA556	–	Reserved	–	–	–	160	–
190	42336	0xA560	LOW	Property byte: User text (freely editable)	–	COM35	PB	8	–
191	42336	0xA560	HIGH	Property byte: Plant identifier (freely editable)	–	COM35	PB	8	–
192	42337	0xA561	LOW	Property byte: Date (freely editable)	–	COM35	PB	8	–
193	42337	0xA561	HIGH	Property byte: Author (freely editable)	–	COM35	PB	8	–

4.5.28 Data set DS 166: IP white list

The table below shows the content of data set 166. This data set is part of the COM35 security functions and restricts write access to the circuit breaker, to the released IP addresses.

Table 4- 58 Content of data set 166

Byte	Modbus register number			Description	Data point	Source WL3	Format	Length (bits)	Scaling
	Dec	Hex	High/Low						
0	42497	0xA601	–	Header; value 0x00 00 00 00	–	COM35	–	32	–
4	42499	0xA603	–	White list IP addresses	508	COM35	Format (508)	1600	–
204	42599	0xA667	–	Authorization status	524	COM35	unsigned int	16	–
206	42600	0xA668	LOW	Property byte (white list IP addresses)	508	COM35	PB	8	–
207	42600	0xA668	HIGH	Property byte (authorization status)	524	COM35	PB	8	–

4.5.29 Data set DS 167: Daylight saving change

The table below shows the content of data set 167. This data set contains all data points that are required for daylight saving change.

Table 4- 59 Content of data set 167

Byte	Modbus register number			Description	Data point	Source WL3	Format	Length (bits)	Scaling
	Dec	Hex	High/Low						
0	42753	0xA701	-	Header; value 0x00 00 00 00	—	COM35	—	32	—
4	42755	0xA703	-	Offset from UTC	504	COM35	signed int	16	—
6	42756	0xA704	-	Switch daylight saving change on/off	505	COM35	unsigned int	16	—
8	42757	0xA705	-	If daylight saving is active	506	COM35	unsigned int	16	—
10	42758	0xA706	-	Date list for daylight saving change	507	COM35	Format (507)	640	—
90	42798	0xA72E	LOW	Property byte (offset from UTC)	504	COM35	PB	8	—
91	42798	0xA72E	HIGH	Property byte (switch daylight saving change on/off)	505	COM35	PB	8	—

Byte	Modbus register number			Description	Data point	Source WL3	Format	Length (bits)	Scaling
	Dec	Hex	High/Low						
92	42799	0xA72F	LOW	Property byte (if daylight saving is active)	506	COM35	PB	8	—
93	42799	0xA72F	HIGH	Property byte (date list for daylight saving change)	507	COM35	PB	8	—

4.6 Formats

4.6.1 Formats of the data points

This section explains the various formats of the data points. General formats for 1, 2 and 4 byte data use standard C language type names such as "int" and "unsigned int". Special formats are listed in tables that indicate the number of the data point that uses the format.

All available data points and the data set in which they are transferred are described on the preceding pages. In the "Format" column, an explanation is given of which data type is referred to and how this content is to be interpreted. A distinction must be made here between generally valid formats and special formats that are usually binary coded.

4.6.2 General data formats

Data points larger than two bytes transmitted in the Motorola Format (Big-Endian).

The table below shows the standard formats used, with their value ranges and purposes.

Table 4- 60 Standard data formats

Format	Length in byte	Signs	Value range un-scaled	Use
Char	1	–	0 ... 255	ASCII characters, parameters
Unsigned char	1	–	0 ... 255	Measured values, parameters
Signed int	2	✓	-32678 ... 32767	Measured values with sign
Unsigned int	2	–	0 ... 65535	Measured values and parameters without sign
Unsigned long	4	–	0 ... 4294967295	Measured values and maintenance information

Format "unsigned int"

The format "unsigned int" is used primarily for transferring parameters and measured values, as well as statistical information. If the value range is insufficient, scaling is used.

To transfer measured values that can also be negative (e.g. power factors), the format "signed int" is used.

Format "unsigned char"

If the value range of a parameter or measured value is severely restricted (e.g. phase unbalance of 0 to 50%), the data type "unsigned char" is sufficient.

Text elements consisting of ASCII characters are assembled using the data type "char". In this case, the data type "unsigned char" indicates a "byte" that can assume a value from the range 0 to 255.

Format "unsigned long"

If the value range is insufficient, the data type "unsigned long" is fallen back on. This is used, for example, with the runtime meter. If "unsigned int" were to be used for this, the runtime meter would overflow after seven-and-a-half years.

Format "hex"

The format "hex" is always used where there is a concatenation of binary information, e.g. when transferring the statuses at the inputs of the binary input module. However, it is also used when hexadecimal numbers are transferred.

Format of the property byte

You will find the description of the format of the property byte PB in Chapter Table 4-63 Format (7) cyclic data (Page 173).

Time format

The S7-compatible time format (DATE_AND_TIME) is used for communicating time stamps. The time stamp in RB100 is represented according to the PROFIBUS standard and is an exception to this rule.

Table 4- 61 Format time

Byte	Bit	Meaning
0	–	Year
1	–	Month
2	–	Day
3	–	Hour
4	–	Minute
5	–	Second
6	–	Low-order digits of milliseconds
7	4 ... 7	Higher-order digits of milliseconds (4MSB)
7	0 ... 3	Weekday (1 = Sunday ... 7 = Saturday)

All time stamps are transferred in this format.

Table 4- 62 PROFIBUS time format

Byte	Bit	Meaning
0	–	Higher-order digits of milliseconds
1	–	Low-order digits of milliseconds
2	–	Minute
3	0 ... 4	Hour
3	7	<ul style="list-style-type: none"> • 1 = Daylight saving time • 0 = Standard time
4	0 ... 4	Day of the month (1 ... 31)
4	5 ... 7	Weekday (1 = Monday ... 7 = Sunday)
5	–	Month
6	–	Year (02 = 2002)
7	–	Reserved

This time format is compliant with the PROFIBUS time format.

See also

Special data formats (Page 172)

4.6.3 Advanced protection functions formats

Advanced protection functions Parameters	DP	Setting range	Scaling
Phase unbalance current	139	5 ... 50%	0
Phase unbalance current delay	140	0 ... 15 s	0
Active power import	141	1 ... 12000 kW	0
Active power import delay	142	0 ... 15 s	0
Active power infeed	143	1 ... 12000 kW	0
Active power infeed delay	144	0 ... 15 s	0
Rotating field detection	146	0 = L1L2L3 1 = L1L3L2	0
Underfrequency	147	40 ... 70 Hz	-1
Underfrequency delay	148	0 ... 15 s	0
Overfrequency	149	40 ... 70 Hz	-1
Overfrequency delay	150	0 ... 15 s	0
Phase unbalance voltage	151	5 ... 50%	0
Phase unbalance voltage delay	152	0 ... 15 s	0
Undervoltage	153	100 ... 1100 V	0
Undervoltage delay	154	0 ... 15 s	0
Overvoltage	155	200 ... 1200 V	0
Overvoltage delay	156	0 ... 15 s	0
THD current	158	3 ... 50%	0
THD current delay	159	5 ... 15 s	0
THD voltage	160	3 ... 50%	0
THD voltage delay	161	5 ... 15 s	0

4.6.4 Special data formats

Special data formats are used where the inflexible standard formats cannot be used, e.g. for binary coded or compound data points. If a special data format has been used with a data point, this is indicated in the first and second part of this chapter in the format column with **Format (X)**. The X represents a consecutive number of the special data formats used, described below. In most cases, the X in the format agrees with the data point number to simplify the search.

In the case of bit interpretations, the meaning is always to be seen with a high-active signal.

Format (7) cyclic data

The table below shows the format (7) for the data in the cyclic profile of Modbus.

Table 4- 63 Format (7) cyclic data

Byte	Meaning
0	Assignment (data point number) of the 1st data block in the cyclic telegram
2	Assignment (data point number) of the 2nd data block in the cyclic telegram
4	Assignment (data point number) of the 3rd data block in the cyclic telegram
6	Assignment (data point number) of the 4th data block in the cyclic telegram
8	Assignment (data point number) of the 5th data block in the cyclic telegram
10	Assignment (data point number) of the 6th data block in the cyclic telegram
12	Assignment (data point number) of the 7th data block in the cyclic telegram
14	Assignment (data point number) of the 8th data block in the cyclic telegram
16	Assignment (data point number) of the 9th data block in the cyclic telegram
18	Assignment (data point number) of the 10th data block in the cyclic telegram
20	Assignment (data point number) of the 11th data block in the cyclic telegram
22	Assignment (data point number) of the 12th data block in the cyclic telegram
24	Assignment (data point number) of the 13th data block in the cyclic telegram
26	Assignment (data point number) of the 14th data block in the cyclic telegram

Format (10) IP address

The table below shows the format (10) for the IP addresses that consist of four digits from 0 to 255 each separated by a dot, e.g. 192.168.121.101.

Table 4- 64 Format (10) IP address

OFFSET (byte)	Meaning
0	Unsigned int: Sub-IP address X._._._
1	Unsigned int: Sub-IP address _X._._
2	Unsigned int: Sub-IP address _._X._
3	Unsigned int: Sub-IP address _._._X
4	Reserved

Format (14) Write protection

The table below shows the format (14) for write protection. The write protection can be deactivated using a hardware input on COM35.

Table 4- 65 Format (14) Write protection

Byte	Bit	Meaning
0	0	<ul style="list-style-type: none"> • 0 = Write protection active • 1 = No write protection active

4.6.5 Data formats 15 to 24

Format (15) trip log

The table below shows the format (15) trip log. It contains the last 5 trips with time stamp and source.

Table 4- 66 Format (15) trip log

Byte	Bit	Meaning
0 ... 7	Time	Time stamp of the 1st trip event
8	–	Reserved 0x00
9	Trip reason	Trip cause 1st trip event <ul style="list-style-type: none"> • 1 = Overload • 2 = Instantaneous trip • 3 = Short-time delayed trip • 4 = Ground-fault • 5 = Enhanced protection function • 6 = Overload in neutral conductor • 20 = Current unbalance • 21 = Voltage unbalance • 22 = Active power in normal direction • 23 = Active power in reverse direction • 24 = Overvoltage • 25 = Undervoltage • 26 = Overfrequency • 27 = Underfrequency • 28 = THD current • 29 = THD voltage • 30 = Change direction of phase rotation
10	–	Source of 1st tripping operation <ul style="list-style-type: none"> • 14 = Metering function PLUS • 25 = Trip unit
11	–	Reserved 0x00
12 ... 19	–	Time stamp of the 2nd tripping operation
20	–	Reserved 0x00
21	–	Trip reason 2nd trip event
22	–	Source of 2nd tripping operation
23	–	Reserved 0x00
24 ... 31	–	Time stamp of the 3rd tripping operation
32	–	Reserved 0x00
33	–	Trip reason 3rd trip event
34	–	Source of 3rd tripping operation

Byte	Bit	Meaning
35	–	Reserved 0x00
36 ... 43	–	Time stamp of the 4th tripping operation
44	–	Reserved 0x00
45	–	Trip reason 4th trip event
46	–	Source of 4th tripping operation
47	–	Reserved 0x00
48 ... 55	–	Time stamp of the 5th tripping operation
56	–	Reserved 0x00
57	–	Trip reason 5th trip event
58	–	Source of 5th tripping operation
59	–	Reserved 0x00

Format (16) Event log

The table below shows the format (16) event log. It contains the last 10 events with time stamp. Example see below.

Table 4- 67 Format (16) Event log

Byte	Bit	Meaning		
0 ... 7	–	Time stamp of the 1st event		
8	–	Reserved 0x00		
9	–	Coming "+"	Going "-"	Event description
		1	2	Overload alarm
		3	4	Overload alarm neutral conductor
		5	6	Load shed alarm
		7	8	Load pickup message
		9	10	Phase unbalance alarm
		11	12	Fault in trip unit
		13	14	Ground-fault alarm
		15	16	Overtemperature alarm
		20	–	Circuit breaker closed
		21	–	Circuit breaker open
		40	41	SP ¹⁾ current
		42	43	SP ground-fault
		44	45	SP overcurrent in neutral conductor
		46	47	SP unbalance current
		48	49	SP current demand
50	51	SP undervoltage		
52	53	SP unbalance voltage		
54	55	SP overvoltage		
56	57	SP active power demand		

Byte	Bit	Meaning
		58 59 SP apparent power demand
		60 61 SP reactive power demand
		62 63 SP reactive power in normal direction
		64 65 SP reactive power in reverse direction
		66 67 SP apparent power
		68 69 SP overfrequency
		70 71 SP underfrequency
		72 73 SP under power factor
		74 75 SP over power factor
		76 77 SP THD current
		78 79 SP THD voltage
		80 81 SP crest factor
		82 83 SP form factor
		84 85 SP active power in normal direction
		86 87 SP active power in reverse direction
10	–	Source of 1st event <ul style="list-style-type: none"> • 14 = Metering function/M. PLUS • 25 = Trip unit
11	–	Reserved 0x00
12-19	–	Time stamp of 2nd event
20	–	Reserved 0x00
21	–	2nd event
22	–	Source of 2nd event
23	–	Reserved 0x00
24-31	–	Time stamp of 3rd event
32	–	Reserved 0x00
33	–	3rd event
34	–	Source of 3rd event
35	–	Reserved 0x00
36-43	–	Time stamp of 4th event
44	–	Reserved 0x00
45	–	4th event
46	–	Source of 4th event
47	–	Reserved 0x00
48-55	–	Time stamp of 5th event
56	–	Reserved 0x00
57	–	5th event
58	–	Source of 5th event
59	–	Reserved 0x00
60-67	–	Time stamp of 6th event
68	–	Reserved 0x00
69	–	6th event

Byte	Bit	Meaning
70	–	Source of 6th event
71	–	Reserved 0x00
72-79	–	Time stamp of 7th event
80	–	Reserved 0x00
81	–	7th event
82	–	Source of 7th event
83	–	Reserved 0x00
84-91	–	Time stamp of 8th event
92	–	Reserved 0x00
93	–	8th event
94	–	Source of 8th event
95	–	Reserved 0x00
96-103	–	Time stamp of 9th event
104	–	Reserved 0x00
105	–	9th event
106	–	Source of 9th event
107	–	Reserved 0x00
108-115	–	Time stamp of 10th event
116	–	Reserved 0x00
117	–	10th event
118	–	Source of 10th event
119	–	Reserved 0x00

1) SP = Alarm setpoint

Table 4- 68 Event log, example (incomplete or excerpts)

Date	Time stamp	Event
06.06.08	14:19:58	– Threshold THD voltage
06.06.08	14:19:44	+ Threshold THD voltage
06.06.08	14:19:24	– Threshold undervoltage
06.06.08	14:19:14	+ Threshold undervoltage

Format (18) Control communication module

The table below shows the format (18) Control communication module for changing the setting of the circuit breaker.

Table 4- 69 Format (18) Control communication module

Byte	Bit	Meaning
0	2	Resets the maintenance counters
0	3	Resets min./max. values for temperatures
0	4	Resets all min./max. values except for temperatures
0	5	Synchronizes the clock to xx:30:00.000
0	6	Deletes the contents of the trip log and event log

Format (24) Position in the guide frame

The table below shows the format (24) position in the guide frame. Data point 24 states the position of the SENTRON WL in the guide frame.

Table 4- 70 Format (24) Position in the guide frame

Byte	Value	Meaning
0	0	Disconnected position
0	1	Connected position
0	2	Test position
0	3	Circuit breaker not available

4.6.6 Data formats 88 to 162

Format (88) CubicleBUS modules

The table below shows the format (88) CubicleBUS modules that contains the modules connected on the CubicleBUS.

Table 4- 71 Format (88) CubicleBUS modules

Byte	Bit	Meaning
0	0	COM15 / COM16 / COM35
0	1	Trip unit ETU
0	2	ZSI module
1	0	Configurable digital output module
1	2	Digital output module No. 2
1	3	Digital input module No. 2
1	4	Breaker Status Sensor BSS
1	5	Digital output module No. 1
1	6	Digital input module No. 1
2	1	BDA PLUS
2	3	Graphical display ETU76B/ETU776
2	4	Analog output module No. 2
2	5	Analog output module No. 1
2	6	Metering function or metering function PLUS

Format (95) Market

The table below shows the format (95) Market specifying the market for which the circuit breaker has been built and tested.

Table 4- 72 Format (95) Market

Byte	Value	Meaning
0	1	IEC 60947-2
0	2	UL489
0	3	ANSI (UL1066)

Format (99) Interrupting class

The table below shows the format (99) Interrupting class that specifies the maximum level of the breaking current.

Table 4- 73 Format (99) Interrupting class

Byte	Value	Meaning
0	2	ECO breaking capacity N / IntClassN
0	3	Standard breaking capacity S / IntClassS
0	4	High breaking capacity H / IntClassH
0	5	Extremely high breaking capacity C / IntClassC

Format (100) Frame size

The table below shows the format (100) Frame size. The size is determined by the rated circuit breaker current and the interrupting class.

Table 4- 74 Format (100) Frame size

Byte	Value	Meaning
0	1	Frame size 1
0	2	Frame size 2
0	3	Frame size 3

Format (103) Air Circuit Breaker part number

The table below shows the format (103) Air Circuit Breaker part number by which the circuit breaker can be identified.

Table 4- 75 Format (103) Air Circuit Breaker part number

Byte	Bit	Meaning
0	–	3
1	–	W
2	–	L
3	–	Market
4	–	Size
5 ... 6	–	Rated current
7	–	Hyphen
8	–	Interrupting class
9	–	ETU <ul style="list-style-type: none"> • E = ETU45B without display • F = ETU45B with display • Y = ETU55B, N = ETU76B

Byte	Bit	Meaning
10	–	ETU supplement <ul style="list-style-type: none"> • B = Without ground-fault module • G = With ground-fault module
11	–	Number of poles
12	–	Type of main connections
13	–	Hyphen
14	–	Operating mechanism
15	–	1st auxiliary release
16	–	2nd auxiliary release
17	–	Auxiliary switch
18	0	Option F02
18	2	Option F04
18	3	Option F05
18	6	Option F01
18	7	Options F20 ... F22
19	0	Option K01
19	1	Options K10 ... K13

Format (107) Interrupted I²t

The table below shows the format (107) Switched-off I²t values that contains the sum of interrupted I²t values per phase in the format "unsigned long".

Table 4- 76 Format (107) Interrupted I²t

Byte	Bit	Meaning
0	–	Phase L1 (unsigned long)
4	–	Phase L2 (unsigned long)
8	–	Phase L3 (unsigned long)
12	–	Phase N (unsigned long)

Format (108) Number of poles

The table below shows the format (108) Number of poles that specifies the number of protected poles for the main circuit.

Table 4- 77 Format (108) Number of poles

Byte	Value	Meaning
0	1	3 poles
0	2	4 poles (with neutral conductor)

Format (111) Switch position DI

The table below shows the format (111) Switch position DI that also distinguishes the switch position of the digital input module between Module 1 and 2.

Table 4- 78 Format (111) Switch position DI

Byte	Value	Meaning
0	1	Parameter set switching (module No. 1)
0	2	6 x digital inputs (module No. 2)

Format (119) Digital output module rotary switch position

The table below shows the format (119) Digital output module rotary switch position that specifies which output block is selected with which delay.

Table 4- 79 Format (119) Digital output module rotary switch position

Byte	Value	Meaning
0	0x01	Module No. 1 Trip instantaneous
0	0x02	Module No. 1 Trip delayed 200 ms
0	0x03	Module No. 1 Trip delayed 500 ms
0	0x04	Module No. 1 Trip delayed 1 s
0	0x05	Module No. 1 Trip delayed 2 s
0	0x06	Module No. 2 Alarm instantaneous
0	0x07	Module No. 2 Alarm delayed 200 ms
0	0x08	Module No. 2 Alarm delayed 500 ms
0	0x09	Module No. 2 Alarm delayed 1 s
0	0x0A	Module No. 2 Alarm delayed 2 s

Format (121) Control outputs of Digital Output module with rotary switch

The table below shows the format (121) Control DO outputs for controlling the outputs of the digital output modules with rotary coding switches.

Table 4- 80 Format (121) Control DO outputs

Byte	Value	Meaning
0	0	No action
	1	Set output 1 ("1")
	2	Reset output 1 ("0")
	3	Set output 2 ("1")
	4	Reset output 2 ("0")
	5	Set output 3 ("1")
	6	Reset output 3 ("0")
	7	Set output 4 ("1")
	8	Reset output 4 ("0")
	9	Set output 5 ("1")
	10	Reset output 5 ("0")
	11	Set output 6 ("1")
	12	Reset output 6 ("0")
	13	Switch force mode off (overwriting of the valid data)

Format (129) Configurable Digital Output Module Event Configuration

The table below shows the format (129) Configurable Digital Output Module Event Configuration. The 1st event of the 1st output provides an example of the assignment for all others.

Table 4- 81 Format (129) Configurable Digital Output Module Event Configuration

Byte	Value	Meaning
0	–	1st event at the 1st output
1	–	2nd event at the 1st output
2	–	3rd event at the 1st output
3	–	4th event at the 1st output
4	–	5th event at the 1st output
5	–	6th event at the 1st output
6	–	1st event at the 2nd output
7	–	2nd event at the 2nd output
8	–	3rd event at the 2nd output
9	–	4th event at the 2nd output
10	–	5th event at the 2nd output
11	–	6th event at the 2nd output
12	–	1st event at the 3rd output

Byte	Value	Meaning
13	–	2nd event at the 3rd output
14	–	3rd event at the 3rd output
15	–	4th event at the 3rd output
16	–	5th event at the 3rd output
17	–	6th event at the 3rd output
18	–	Event at the 4th output
19	–	Event at the 5th output
20	–	Event at the 6th output
0	0x00	Not assigned
0	0x01	Circuit breaker closed
0	0x02	Circuit breaker open
0	0x03	Spring energy store charged
0	0x04	Ready to close
0	0x05	Group warning
0	0x06	Group tripped signal
0	0x07	Write protection active
0	0x08	Communication OK
0	0x3A	Trigger event A occurred
0	0x3B	Trigger event B occurred
0	0x3C	Parameter set A active
0	0x3D	Parameter set B active
0	0x3E	Communication bit 1 (#426)
0	0x3F	Communication bit 2 (#426)
0	0x40	Communication bit 3 (#426)
0	0x41	Communication bit 4 (#426)
0	0x42	Communication bit 5 (#426)
0	0x43	Communication bit 6 (#426)
Warning		
0	0x09	Overload
0	0x0A	Overload neutral conductor
0	0x0B	Load shed threshold
0	0x0C	Ground-fault
0	0x0D	Overtemperature
0	0x0E	µP error
0	0x0F	Phase unbalance current
0	0x10	Load pickup level

Byte	Value	Meaning
Trips		
0	0x11	Overload/long-time
0	0x12	Instantaneous I
0	0x13	Short-time delayed S
0	0x15	Ground-fault G
0	0x16	Overload in neutral conductor N
0	0x17	Phase unbalance current
0	0x18	Phase unbalance voltage
0	0x19	Underfrequency
0	0x1A	Overfrequency
0	0x1B	Undervoltage
0	0x1C	Overvoltage
0	0x1D	Active power in normal direction
0	0x1E	Active power in reverse direction
0	0x1F	THD current
0	0x20	THD voltage
0	0x21	Reverse direction of phase rotation
Setpoint alarm		
0	0x22	Overcurrent
0	0x23	Overcurrent neutral conductor
0	0x24	Overcurrent ground-fault
0	0x25	Phase unbalance current
0	0x26	Phase unbalance voltage
0	0x27	Demand
0	0x28	Undervoltage
0	0x29	Overvoltage
0	0x2A	THD current
0	0x2B	THD voltage
0	0x2C	Crest factor
0	0x2D	Form factor
0	0x2E	Underfrequency
0	0x2F	Overfrequency
0	0x30	Active power in normal direction
0	0x31	Active power in reverse direction
0	0x32	Apparent power
0	0x33	Reactive power in normal direction
0	0x34	Reactive power in reverse direction
0	0x35	cos phi capacitive
0	0x36	cos phi inductive
0	0x37	Active power demand
0	0x38	Reactive power demand
0	0x39	Apparent power demand

Format (138) Type of metering function

The table below shows the format (138) Type of metering function. It specifies which type of metering function is built in.

Table 4- 82 Format (138) Type of metering function

Byte	Value	Meaning
0	0x00	No metering function
0	0x02	Metering function
0	0x03	Metering function PLUS

Format (145) Direction of incoming supply

The table below shows the format (145) Direction of incoming supply. The signs for active power and reactive power depend on the "Direction of incoming supply".

Table 4- 83 Format (145) Direction of incoming supply

Byte	Value	Meaning
0	0	From top to bottom
0	1	From bottom to top

Format (146) Direction of phase rotation

The table below shows the format (146) Direction of phase rotation. The normal status of the direction of phase rotation can be set using this.

Table 4- 84 Format (146) Direction of phase rotation

Byte	Value	Meaning
0	0	Right (e.g. L1 – L2 – L3)
0	1	Left (e.g. L1 – L3 – L2 or similar)

Format (162) Voltage transformer

The table below shows the format (162) Voltage transformer. The setting of the primary connection also influences the location of the measured voltage variables.

Table 4- 85 Format (162) Voltage transformer

Byte	Value	Meaning
0	0	The voltage transformer is delta-connected on the primary side.
0	1	The voltage transformer is star(wye)-connected on the primary side.

4.6.7 Data formats 307 to 373

Format (307) Trips by the extended protective functions (metering)

The table below shows the format (307) Trips by the extended protective functions (metering), which displays the content of the last trip by the advanced protection function.

Table 4- 86 Format (307) Trips by the extended protective functions (metering)

Byte	Value	Meaning
0 / 1	0x0000	No trip
0 / 1	0x0001	Phase unbalance current
0 / 1	0x0002	Phase unbalance voltage
0 / 1	0x0004	Active power in normal direction
0 / 1	0x0008	Active power in reverse direction
0 / 1	0x0040	Overvoltage
0 / 1	0x0080	Undervoltage
0 / 1	0x0100	Overfrequency
0 / 1	0x0200	Underfrequency
0 / 1	0x0400	THD current
0 / 1	0x0800	THD voltage
0 / 1	0x1000	Change in direction of phase rotation

Format (308) Setpoint alarms

The table below shows the format (308) Setpoint alarms that displays the currently pending setpoint warnings.

Table 4- 87 Format (308) Setpoint alarms

Byte	Bit	Meaning
1	0	cos phi capacitive
1	1	cos phi inductive
1	2	THD current
1	3	THD voltage
1	4	Crest factor
1	5	Form factor
1	6	Active power in normal direction
1	7	Active power in reverse direction
2	0	Active power demand
2	1	Apparent power demand
2	2	Reactive power demand
2	3	Reactive power in normal direction
2	4	Reactive power in reverse direction
2	5	Apparent power

Byte	Bit	Meaning
2	6	Overfrequency
2	7	Underfrequency
3	0	Overcurrent
3	1	Overcurrent ground-fault
3	2	Overcurrent neutral conductor
3	3	Phase unbalance current
3	4	Current demand
3	5	Undervoltage
3	6	Phase unbalance voltage
3	7	Overvoltage

Format (309) Harmonics analysis

The table below shows the format (309) Harmonics analysis. To calculate, the value must be multiplied by the signed exponent.

Table 4- 88 Format (309) Harmonics analysis

Harmonic	Byte	Format	Meaning
1st	0	Signed char	Harmonic current: Exponent
	1	Unsigned char	Harmonic current: Value
	2	Signed char	Harmonic voltage: Exponent
	3	Unsigned char	Harmonic voltage: Value
2nd	4	Signed char	Harmonic current: Exponent
	5	Unsigned char	Harmonic current: Value
	6	Signed char	Harmonic voltage: Exponent
	7	Unsigned char	Harmonic voltage: Value
3rd to 28th	8 ... 111
29th	112	Signed char	Harmonic current: Exponent
	113	Unsigned char	Harmonic current: Value
	114	Signed char	Harmonic voltage: Exponent
	115	Unsigned char	Harmonic voltage: Value

Format (328) Status of the circuit breaker

The table below shows the format (328) Status of the circuit breaker.

Table 4- 89 Format (328) Status of the circuit breaker

Byte	Bit	Meaning
0	0	Circuit breaker open
0	1	Circuit breaker closed
0	2	Circuit breaker has tripped (trip alarm switch)
0	3	Circuit breaker ready to close
0	4	Spring energy store charged
0	5	First auxiliary release (shunt trip) operated
0	6	Second auxiliary release (UVR) operated

Format (343) I²t characteristic for short-time delayed overcurrent

The table below shows the format (343) I²t characteristic for short-time delayed overcurrent with which the I²t characteristic is switched on and off.

Table 4- 90 Format (343) I²t characteristic for short-time delayed overcurrent

Byte	Value	Meaning
0	0	I ² t characteristic for delayed short-circuit protection switched off (default).
0	1	I ² t characteristic for delayed short-circuit protection switched on.

Format (344) I²t characteristic for ground-fault protection

The table below shows the format (344) I²t characteristic for ground-fault protection with which the I²t characteristic is switched on and off.

Table 4- 91 Format (344) I²t characteristic for ground-fault protection

Byte	Value	Meaning
0	0	I ² t characteristic for ground-fault protection switched off (default).
0	1	I ² t characteristic for ground-fault protection switched on.

Format (345) I^{4t} characteristic for Long-time/Overload protection

The table below shows the format (345) I^{4t} characteristic for L with which the I^{4t} characteristic is switched on and off.

Table 4- 92 Format (345) I^{4t} characteristic for L

Byte	Value	Meaning
0	0	I ^{4t} characteristic for long-time/overload protection switched off (default).
0	1	I ^{4t} characteristic for overload protection switched on.

Format (346) Thermal memory

The table below shows the format (346) Thermal memory by which the thermal memory is switched on and off.

Table 4- 93 Format (346) Thermal memory

Byte	Value	Meaning
0	0	Thermal memory deactivated (default)
0	1	Thermal memory activated

Format (347) Phase loss sensitivity

The table below shows the format (347) Phase loss sensitivity with which the phase loss sensitivity is switched on and off.

Table 4- 94 Format (347) Phase loss sensitivity

Byte	Value	Meaning
0	0	Phase loss sensitivity deactivated (default)
0	1	Phase loss sensitivity activated

Format (370) Active parameter set

The table below shows the format (370) Active parameter set that specifies which of the parameter sets is active.

Table 4- 95 Format (370) Active parameter set

Byte	Value	Meaning
0	0	Parameter set A active
0	1	Parameter set B active

Format (373) Phase number

The table below shows the format (373) "Phase number" that specifies the phase number of the phase under the greatest load and the phase of the tripping operation.

Table 4- 96 Format (373) Phase number

Byte	Value	Meaning
0	0	Phase L1
0	1	Phase L2
0	2	Phase L3
0	3	Neutral conductor
0	4	Ground-fault

4.6.8 Data formats 401 to 478

Format (401) Trip unit: Trips

The table below shows the format (401) Trip unit: tripping operations, which shows the last unacknowledged trip by the trip unit.

Table 4- 97 Format (401) Trip unit: Trips

Byte	Value	Meaning
0	0x00	No trip
0	0x01	Overload/long-time (L)
0	0x02	Instantaneous trip (I)
0	0x04	Short-time delay trip (S)
0	0x08	Ground-fault (G)

Format (402) Trip unit: Warnings

The table below shows the format (402) Trip unit: warnings by which the trip unit communicates the currently pending warnings.

Table 4- 98 Format (402) Trip unit: Warnings

Byte	Bit	Meaning
0	0	Overload
0	1	Overload neutral conductor
0	2	Load shed threshold
0	3	Load pickup level
0	4	Phase unbalance current
0	5	Microprocessor error
0	6	Ground-fault
0	7	Overtemperature
1	0	Leading signal of overload trip
1	1	Average current

Format (405) Contact condition

The table below shows format (405) Contact condition that is calculated empirically from the maintenance information.

Table 4- 99 Format (405) Contact condition

Byte	Value	Meaning
0	0	No maintenance necessary yet on main contacts Note: Despite this, the main contacts must be checked after every over-current tripping operation.
0	1	Perform immediate visual inspection on main contacts.
0	2	Prepare maintenance of the main contacts.

Format (406) Control trip unit

The table below shows the format (406) Control trip unit, e.g. in which the statistical information can be reset.

Table 4- 100 Format (406) Control trip unit

Byte	Value	Meaning
0 / 1	0x0002	Delete last trip message in trip unit
0 / 1	0x0022	Reset counter and statistical information of the trip unit

Format (410) Ground-fault sensing method

The table below shows the format (410) Ground-fault sensing method with which the ground-fault sensing method is set.

Table 4- 101 Format (410) Ground-fault sensing method

Byte	Value	Meaning
0	0	GF sensing with external iron-core CT
0	1	GF sensing via residual method (vector summation)
0	2	Reserved

Format (411) Neutral sensor

The table below shows format (411) Neutral sensor that indicates whether a neutral sensor is connected.

Table 4- 102 Format (411) Neutral sensor

Byte	Value	Meaning
0	0	No neutral sensor installed
0	1	Neutral sensor installed

Format (412) Trip unit type

The table below shows the format (412) Trip unit type that indicates which trip unit is installed.

Table 4- 103 Format (412) Trip unit type for 3WL

Byte	Value	IEC/UL	Meaning
0	4	IEC	ETU45B
0	5	IEC	ETU45B with display
0	6	IEC	ETU45B with ground-fault protection
0	7	IEC	ETU45B with display and ground-fault protection
0	13	IEC	ETU76B
0	14	IEC	ETU76B with ground-fault protection
0	17	UL	ETU748
0	18	UL	ETU748 with display
0	19	UL	ETU748 with ground-fault protection
0	20	UL	ETU748 with display and ground-fault protection
0	22	UL	ETU776
0	23	UL	ETU745

Format (421) Parameter ZSI

The table below shows the format (421) Parameter ZSI.

Table 4- 104 Format (421) Parameter ZSI

Byte	Bit	Meaning	
0	0	ZSI for short-time active	
0	1	ZSI for ground-fault active	
0	2	Not used	
0	3	Not used	
0	4 ... 5	0	ZSI disabled
		1	ZSI input and output active
		2	ZSI output active
0	6	Not used	
0	7	Not used	

Format (426) Configurable digital output control

The table below shows the format (426) for controlling the outputs of the configurable digital output module.

Table 4- 105 Format (426) Configurable digital output control

Byte	Bit	Meaning
0	0	Communication bit 1
0	1	Communication bit 2
0	2	Communication bit 3
0	3	Communication bit 4
0	4	Communication bit 5
0	5	Communication bit 6

Format (476) IPv4 suite

The table below shows the format (476) IPv4 suite.

Table 4- 106 Format (476) IPv4 suite

Byte	Meaning
0 ... 3	IPv4 host address
4 ... 7	IPv4 sub net mask
8 ... 11	IPv4 gateway address

Format (478) COM35 I/O configuration

The table below shows the format (478) I/O configuration of the COM35.

Table 4- 107 Format (478) COM35 I/O configuration

OFFSET [byte]	Bit	Meaning	
0	0	Set the user output manually.	
0	1	Reset the user output manually.	
0	2	Activate "OPEN" output (for 500 ms)	
0	3	Activate "CLOSE" output (for 500 ms)	
0	4	Set user output "FREE" to tripped indication.	
0	5	Set user output "FREE" to Parameter Set B.	
0	6	Set user output "FREE" to manual activation.	
0	7	Set user output "FREE" to switch parameter sets.	
1	0	Mode of user output	
		00	User output mode = tripped indication
		01	User output mode = manual activation (bit 0 set)
		10	User output mode = switch parameter sets (bit 1 set)
1	2	Mode of the free user input "FREE"	
		0	Parameter set switchover inactive
		1	Parameter set switchover active
1	3	Read status of user output	
1	4	Read status of user input	
1	5	Switch over user output mode to manual operation	
1	6 ... 7	Reserved	

For more information, see the following chapters:

Format (507) DST table

Format (507) DST table – Time synchronization (Page 40)

Format (508) white list

Format (508) white list – IP white list (Page 33)

4.6.9 Data formats of the basic types

Each basic type starts with a binary status information item the format of which cannot be modified:

Table 4- 108 Binary status information

Bit	Value	SENTRON WL
0 / 1	0 ... 3	Position of the circuit breaker in the guide frame
	0	Disconnected position
	1	Connected position
	2	Test position
	3	Circuit breaker not available.
2 / 3	0 ... 3	Status of the circuit breaker
	0	Not ready.
	1	Open
	2	Closed
	3	Breaker has tripped and is open.
4		Ready-to-close
5		Undervoltage release
6		Spring energy store is charged.
7		Overload alarm is pending (long-time pickup is active)
8		An setpoint threshold has been exceeded.
9		An alarm message is pending.
10		Write protection not active, remote changes possible
11		Status of the free user output
12 ... 14	0 ... 7	Reason for last trip
	0	No trip or last trip acknowledged.
	1	Overload trip, long-time (L)
	2	Instantaneous trip (I)
	3	Short-time delay trip (S)
	4	Ground-fault trip (G tripping)
	5	Extended protective function trip
	6	Neutral overload trip
7		
15		Load shed alarm

The three basic types have the following basic settings:

Basic type 1

Table 4- 109 Basic type 1

Byte	Definition	Default	Data point
0 / 1	Binary status information	Binary status information	–
2 / 3	Data block 1	Current in phase 1	380
4 / 5	Data block 2	Current in phase 2	381
6 / 7	Data block 3	Current in phase 3	382
8 / 9	Data block 4	Maximum current in phase under highest load	374
10	PB of data block 1	PB of the current in phase 1	–
11	PB of data block 2	PB of the current in phase 2	–
12	PB of data block 3	PB of the current in phase 3	–
13	PB of data block 4	PB of the maximum current in phase under highest load	–

Basic type 2

Table 4- 110 Basic type 2

Byte	Definition	Default	Data point
0 / 1	Binary status information	Binary status information	–
2 / 3	Data block 1	Current in phase 1	380
4 / 5	Data block 2	Current in phase 2	381
6 / 7	Data block 3	Current in phase 3	382
8 / 9	Data block 4	Maximum current in phase under highest load	374
10 / 11	Data block 5	Current in neutral conductor	375
12 / 13	Data block 6	Average phase-to-phase voltages	203
14 / 15	Data block 7	Average 3-phase power factor	168
16 / 17	Data block 8	Total active energy of 3 phases	238
18	PB of data block 1	PB of the current in phase 1	–
19	PB of data block 2	PB of the current in phase 2	–
20	PB of data block 3	PB of the current in phase 3	–
21	PB of data block 4	PB of the maximum current in phase under highest load	–
22	PB of data block 5	PB of current in neutral conductor	–
23	PB of data block 6	PB of the average phase-to-phase voltages	–
24	PB of data block 7	PB of the average power factor, 3-phase	–
25	PB of data block 8	PB of total active energy	–

Basic type 3

Table 4- 111 Basic type 3

Byte	Definition	Default	Data point
0 / 1	Binary status information	Binary status information	–
2 / 3	Data block 1	Current in phase 1	380
4 / 5	Data block 2	Current in phase 2	381
6 / 7	Data block 3	Current in phase 3	382
8 / 9	Data block 4	Maximum current in phase under highest load	374
10 / 11	Data block 5	Current in neutral conductor	375
12 / 13	Data block 6	Phase-to-phase voltage L ₁₂	197
14 / 15	Data block 7	Phase-to-phase voltage L ₂₃	198
16 / 17	Data block 8	Phase-to-phase voltage L ₃₁	199
18 / 19	Data block 9	Line-to-neutral voltage L _{1N}	200
20 / 21	Data block 10	Line-to-neutral voltage L _{2N}	201
22 / 23	Data block 11	Line-to-neutral voltage L _{3N}	202
24 / 25	Data block 12	Average 3-phase power factor	168
26 / 27	Data block 13	Total active energy of 3 phases	238
28 / 29	Data block 14	3-phase apparent power	217
30	PB of data block 1	PB of the current in phase 1	–
31	PB of data block 2	PB of the current in phase 2	–
32	PB of data block 3	PB of the current in phase 3	–
33	PB of data block 4	PB of the maximum current in phase under highest load	–
34	PB of data block 5	PB of current in neutral conductor	–
35	PB of data block 6	PB of the phase-to-phase voltage L ₁₂	–
36	PB of data block 7	PB of the phase-to-phase voltage L ₂₃	–
37	PB of data block 8	PB of the phase-to-phase voltage L ₃₁	–
38	PB of data block 9	PB of the line-to-neutral voltage L _{1N}	–
39	PB of data block 10	PB of the line-to-neutral voltage L _{2N}	–
40	PB of data block 11	PB of the line-to-neutral voltage L _{3N}	–
41	PB of data block 12	PB of the average power factor, 3-phase	–
42	PB of data block 13	PB of total active energy	–
43	PB of data block 14	PB of total apparent power	–

Troubleshooting/FAQs

Typical error scenarios and how to resolve them are described in the following chapter.

It is not possible to change the network parameters (IP addresses) during commissioning.	COM35 has write protection, which is activated by default. Solution: To deactivate write protection, terminals 1 and 2 on the COM35 must be connected. For more information, see Chapter Write protection (Page 21).
It is not possible to change the network parameters (IP addresses) during commissioning in powerconfig.	Edit mode is not active by default in the device search (F11) of powerconfig. It is not possible to change parameters in this mode. Solution: Edit mode must be activated (unlock) in the device search of powerconfig.
The COM35 does not start up correctly or sporadically reboots.	The 24 V energy supply is not adequately dimensioned. The 3WL ETU requires a high starting current. This can result in the 24 V dipping so that not enough power is available for the COM35. Solution: Use a larger 24 V power supply or a separate power supply for the COM35. See Table 2-7 Supply voltage or 3WL Operating Manual, chapter "External power supply".
Sporadic failure of CubicleBUS nodes occurs. The CubicleBUS LED (CUB) is flashing or sporadically flashing green.	The CubicleBUS is a serial bus, so if it fails, the nodes are no longer available. Solution: Check the points of contact and connectors of the CubicleBUS and reconnect, if necessary.
Sporadically, not all circuit breaker data are available.	The CubicleBUS is a serial bus that must be terminated with a resistor (120 ohm) at its ends. Solution: Connect a terminating resistor to the last node of the CubicleBUS.
Sporadically, not all circuit breaker data are available. The CubicleBUS LED (CUB) is lit red or sporadically lit red.	The CubicleBUS can be disturbed by EMC interference. This can result in data loss on the CubicleBUS. Solution: Reduce EMC interference with suitable measures. Reduce EMC interference with suitable measures.
All LEDs on the COM35 are flashing red.	The COM35 monitoring has detected a fault and is not ready. Solution: Try to restore the factory settings on the COM35 by pressing button S1. If this error cannot be eliminated, replace the COM35.
The COM35 can no longer be addressed via Modbus TCP.	The COM35 has security functions that can prevent access. Solution: Check the port address of the COM35 and possibly the settings on your network devices.
Parameters can be read but not modified via Modbus TCP.	The COM35 has security functions that can prevent modification of parameters. Solution: Check the security functions or whether the COM35 write protection is active.

ESD Guidelines

A.1 Electrostatic sensitive devices (ESD)

ESD components are destroyed by voltage and energy far below the limits of human perception. Voltages of this kind occur as soon as a device or an assembly is touched by a person who is not electrostatically discharged. ESD components which have been subject to such voltage are usually not recognized immediately as being defective, because the malfunction does not occur until after a longer period of operation.

ESD Guidelines

NOTICE

Electrostatic sensitive devices

Electronic modules contain components that can be damaged by electrostatic discharge as a result of improper handling.

- You must discharge your body electrostatically immediately before touching an electronic module. To do this, touch a conductive, grounded object, e.g., a bare metal part of a switch cabinet or the water pipe.
- Always hold the component by the plastic enclosure.
- Electronic modules should not be brought into contact with electrically insulating materials such as plastic film, plastic parts, insulating table supports or clothing made of synthetic fibers.
- Always place electrostatic sensitive devices on conductive bases.
- Always store and transport electronic modules or components in ESD-safe conductive packaging, e.g. metalized plastic or metal containers. Leave the component in its packaging until installation.

NOTICE

Storage and transport

If you have to store or transport the component in non-conductive packaging, you must first pack the component in ESD-safe, conductive material, e.g., conductive foam rubber, ESD bag.

A.1 Electrostatic sensitive devices (ESD)

The diagrams below illustrate the required ESD protective measures for electrostatic sensitive devices.

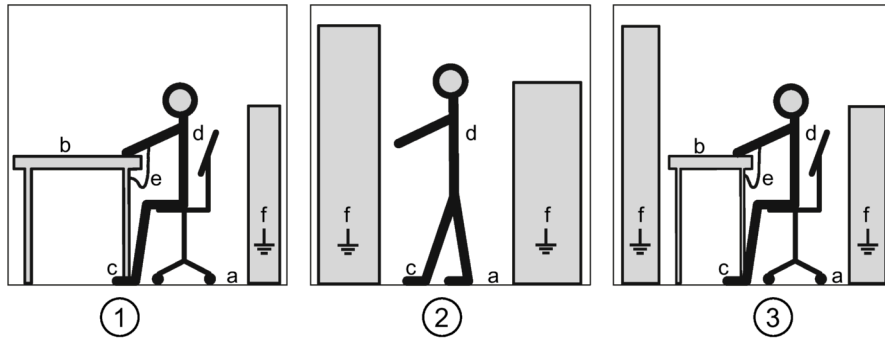

- (1) ESD seat
- (2) ESD standing position
- (3) ESD seat and ESD standing position

Protective measures

- a Conductive floor
- b ESD table
- c ESD footwear
- d ESD smock
- e ESD bracelet
- f Cubicle ground connection

List of abbreviations

You can find more abbreviations, especially with regard to possible settings, in the 3WL Manual.

Table B- 1 List of abbreviations

Abbreviation	Meaning
AC	Alternating Current
AWG	American Wire Gauge
BSS	Breaker Status Sensor
COM35	Communication module 3WL for PROFINET IO and Modbus TCP
CUB -	CubicleBUS, connection "-"
CUB +	CubicleBUS, connection "+"
DAS	Dynamic Arc Sentry
DC	Direct Current
DFP	Dynamic Frame Packing
DI	Digital input module
DIN	German Industry Standard
DO	Digital output module
DST	Daylight Saving Time
PB	Property Bytes
ED	ON time; exceeding the permissible ON time results in destruction
ESD	Electrostatic sensitive device
EN	European standard
EMC	Electromagnetic compatibility
ETU	Electronic Trip Unit
EXTEND	Enhanced protection function
F1	First shunt release
F2	Second shunt release
F3	Undervoltage release
F4	Undervoltage release with delay
F5	Tripping solenoid
F7	Remote reset magnet
FIFO	First In/First Out memory
FIFO memory	Storage method by which the items that were stored first are the first to be removed from the memory.
GSDML	General Station Description Markup Language
I/O	Input/Output
I tripping	Instantaneous short-circuit trip
ID	Identification number

Abbreviation	Meaning
IEC	International Electrotechnical Commission
Conf. DO	Configurable digital output module
L1	Primary conductor/phase 1
L2	Primary conductor/phase 2
L3	Primary conductor/phase 3
LED	Light emitting diode
LV	Low Voltage
LVSG	(Low Voltage Switchgear)
M	Motor
MRP	Media redundancy protocol
Meter. fct.	Metering function or metering function PLUS
MV	Medium Voltage
N	Neutral conductor
PNO	PROFIBUS User Organization
PS	Parameter set
OB	Organization blocks (PLC)
Ö	Normally closed contact
S	Normally open contact
S1	Micro-switch, switch position
S10	Electrical ON
S12	Motor cutout switch
S13	Cutout switch for remote reset
S14	Cutout switch for shunt release F1 (overexcited)
S15	Cutout switch for closing coil Y1 (overexcited)
S22	Micro-switch on 1st auxiliary trip unit
S23	Micro-switch on 2nd auxiliary trip unit
S24	Tripped signaling switch
S42	Micro-switch on CubicleBUS side on first auxiliary trip unit F1
S43	Micro-switch on CubicleBUS side on second auxiliary trip unit F2, F3 or F4
S7	Micro-switch, switch position
S8	Signaling switch, switch position
SNTP	Simple Network Time Protocol
SP	Setpoint alarm
ST	Shunt release
T.U. ERROR	Trip unit error, fault in the electronic trip unit (ETU)
TEST	Test position
t_{sd}	Delay time for short time-delayed short-circuit protection
t_{zsl}	Guaranteed non-tripping time
UL	Underwriters Laboratories Inc.
UVR	Undervoltage release instantaneous
UVR t_d	Undervoltage release delayed
VDE	Association for Electrical, Electronic and Information Technologies (Germany)

Abbreviation	Meaning
VT	Voltage transformers
X	Terminal marking according to DIN
Y1	Closing coil
TS	Time stamp
ZSI	Zone Selective Interlocking

Index

3

3WL

- COM35, 46

3WL accessories

- 7KN Powercenter 3000, 90
- DSP800, 83
- TD400, 85

7

7KN Powercenter 3000

- 3WL accessories, 90
- Requirements, 91
- Setting values, 91
- Technical data, 92

A

- Active parameter set, 190

- Acyclic data traffic, 66

- Addressing I&M data sets

 - PROFINET, 67

- Advanced protection functions

 - Formats, 172

- Alarm

 - Diagnostic/maintenance, 71

 - Hardware interrupt, 71

- AlarmSpecifier, 73

- AlarmType, 72

- API, 72

- Approved modifications

 - Write protection, 21

- Authorization status

 - IP white list, 35

B

- Basic type 1, 62

- Basic type 2, 63

- Basic type 3, 64

- Batteries

 - TD400, 90

- BlockLength, 72

- BlockType, 72

- BlockVersion, 72

- Bluetooth

 - TD400, 89

C

- ChannelErrorType, 76, 77

- ChannelNumber, 73

- ChannelProperties, 74

- ChannelProperties.Accumulative, 74

- ChannelProperties.Direction, 76

- ChannelProperties.Qualifier, 75

- ChannelProperties.Specifier, 75

- ChannelProperties.Type, 74

- Circuit breaker

 - Closing/opening, 18

 - Communication, 109

 - Enhanced protection function, 107

 - Measured value setting, 109

 - Position, 13

 - Primary protection function, 106

 - Threshold alarms, 108

- Circuit diagram

 - DAS, 25

- Classroom

 - Training, 8

- COM35, 47

 - 3WL, 46

 - Alarm, 70

 - Ambient conditions, 51

 - Ambient temperatures, 14

 - Approvals, 51

 - Circuit breaker position, (Detection)

 - Clock, 13

 - Communication, 50

 - Components, 17

 - Connection elements, 50

 - Connections, 17

 - CubicleBUS, 16

 - Current carrying capacity, 48

 - Degree of protection, 50

 - Device configuration, 47

 - Digital input, 48

 - Digital output, 49

 - Dimensions, 50

 - Disable write access, 21

 - Displays, 12

 - Energy consumption, 48

- Error event, 70
- Error telegram, 69
- Event log, 47
- Factory settings, 36, 37
- Firmware, 36
- Function button, 14
- Function codes, 80
- Functions, 11
- GSDML file, 55
- Hardware write protection, 31
- Installation location, 14
- IP filter, 32
- Micro-switch, 30
- Modbus function codes, 80
- Modbus TCP, 15
- Modbus TCP protocol, 79
- Performance features, 52
- Port list, 31
- powerconfig, 38
- PROFINET, 16
- PROFINET IO, 51
- Protection class, 50
- Resetting, 36, 37
- Security, 13
- Security functions, 30, 31
- Standards, 14, 51
- Supply voltage, 48
- Switch function, 13
- System time, 40, 40
- Technical data, 14
- Temperature sensor, 13
- Temperatures, 14
- Terminal assignment, 16
- Terminal strip connection, 20
- Time synchronization, 40, 40
- Trip log, 47
- Weights, 50
- Wiring, 18
- Write protection application, 22
- COM35
 - RJ45 connection, 20
- Communication bit, 194
- Components
 - DAS, 24
- Conductive floor, 202
- Configurable Digital Output Module Event
- Configuration, 183
- Contact state, 192
- Control bytes, 61
- Control communication module, 178
- Control outputs, 183
- Control trip unit, 192

- Cubicle ground connection, 202
- CubicleBUS
 - COM35, 16
 - Node, 20
- CubicleBUS modules
 - Format, 179
- Cyclic data, 173

D

- DAS
 - Circuit diagram, 25
 - Components, 24
 - Free user input/output, 29
 - Maintenance mode, 27
 - Standards, 26
- DAS with coupling relays
 - Maintenance mode, 28
- Data block
 - AlarmSpecifier, 73
 - AlarmType, 72
 - API, 72
 - BlockLength, 72
 - BlockType, 72
 - BlockVersion, 72
 - ChannelErrorType, 76
 - ChannelNumber, 73
 - ChannelProperties, 74
 - ChannelProperties.Accumulative, 74
 - ChannelProperties.Direction, 76
 - ChannelProperties.Qualifier, 75
 - ChannelProperties.Specifier, 75
 - ChannelProperties.Type, 74
 - ModuleIdentNumber, 72
 - SlotNumber, 72
 - SubmoduleIdentNumber, 72
 - SubslotNumber, 72
 - UserStructureIdentifier, 73
- Data formats
 - Basic type 1, 197
 - Basic type 2, 197
 - Basic type 3, 198
- Data library, 93
 - Data points, 93
- Data points
 - Control, 96
 - Diagnostics, 97
 - Formats, 169
 - Identification, 99
 - IP white list, 34

- Measured values, (Current), (Voltage), (Power), (Other), (Time stamp)
 - SNTP, 42
 - Data sets
 - PROFINET, 66
 - Data traffic
 - Acyclic, 57, 66
 - Cyclic, 57
 - Daylight Saving Time, 44
 - Daylight saving time/standard time
 - DST table, 46
 - Parameter formats, 44
 - Requirements, 43
 - Setting values, 44
 - Diagnostic interrupt/maintenance alarm, 71
 - Diagnostics
 - Data points, 97
 - Digital output module rotary switch position, 182
 - Direction of incoming supply, 186
 - Direction of phase rotation, 186
 - Disable write access
 - COM35, 21
 - Discharge, 201
 - DSP800
 - 3WL accessories, 83
 - Requirements, 84
 - Setting values, 84
 - Technical data, 84
 - DST table
 - Daylight saving time/standard time, 46
 - Format, 195
- E**
- Electrostatic sensitive devices, 201
 - Error telegram, 69
 - ESD bracelet, 202
 - ESD footwear, 202
 - ESD protective measures, 202
 - ESD seat, 202
 - ESD smock, 202
 - ESD standing position, 202
 - ESD table, 202
 - ETU
 - Parameter set A, 29
 - Parameter set B, 29
 - Event log, 47, 175
 - ExtChannelErrorType, 77
- F**
- Factory setting, 38
 - Reset, 37
 - Firmware, 39
 - Update, 36
 - Firmware update
 - powerconfig, 38
 - Format, 187
 - Active parameter set, 190
 - Communication bit, 194
 - Configurable Digital Output Module Event Configuration, 183
 - Contact state, 192
 - Control outputs, 183
 - Control trip unit, 192
 - CubicleBUS modules, 179
 - Cyclic data, 173
 - Digital output module rotary switch position, 182
 - Direction of incoming supply, 186
 - Direction of phase rotation, 186
 - DST table, 195
 - Event log, 175
 - Frame size, 180
 - Ground-fault sensing method, 193
 - Harmonics analysis, 188
 - hex, 170
 - I/O configuration, 195
 - I2t characteristic for ground-fault protection, 189
 - I2t characteristic for short-time delayed overcurrent, 189
 - I4t characteristic for L, 190
 - Interrupting class, 180
 - IP addresses, 173
 - IPv4 suite, 194
 - Market, 179
 - Neutral sensor, 193
 - Number of poles, 181
 - Parameter ZSI, 194
 - Part number of circuit breaker, 180
 - Phase loss sensitivity, 190
 - Phase number, 191
 - Position in the guide frame, 178
 - Property Bytes, 170
 - Requirement Trips, 191
 - Requirement Warnings, 192
 - Standard, 169
 - Status of the circuit breaker, 189
 - Switch position DI, 182
 - Switched-off I2t values, 181
 - Thermal memory, 190
 - Time, 171
 - Trip log, 174

- Trip unit type, 193
- Trips by the extended protective functions (metering), 187
- Type of metering function, 186
- unsigned char, 170
- unsigned int, 170
- unsigned long, 170
- Voltage transformers, 186
- White list, 195
- Write protection, 173

Format 508, 34

FormatFormat

- Control communication module, 178

Formats

- Advanced protection functions, 172

Frame size, 180

Function button, 14, 37

Function code 03, 80

Function code 04, 81

Function code 16, 81

G

- Ground-fault sensing method, 193
- GSDML file, 55

H

- Hardware interrupt, 71
- Harmonics analysis, 188
- hex
 - Format, 170

I

- I&M device identification
 - PROFINET, 66
- I/O configuration, 195
- I2t characteristic for ground-fault protection, 189
- I2t characteristic for short-time delayed overcurrent, 189
- I4t characteristic for L, 190
- Interfaces
 - TD400, 88
- Interrupting class, 180
- IP addresses, 173
- IP filter, 32
- IP white list
 - Authorization status, 35
 - Data points, 34

- Requirements, 33
- Setting values, 33

IPv4 suite, 194

L

- LED
 - COM35, 12
- LEDs
 - TD400, 89
- Locked modifications
 - Write protection, 21

M

- Magnetic rear
 - TD400, 89
- Main entry, 187
- Maintenance mode
 - DAS, 27
 - DAS with coupling relays, 28
- Market, 179
- Measured values
 - Scaling, 94
- Metered values
 - PROFINET, 53
- Modbus function code 03, 80
- Modbus function code 04, 81
- Modbus function code 16, 81
- Modbus TCP, 35, 51, 80
 - Addressing the device, 80
- Modbus TCP protocol, 79
- ModuleIdentNumber, 72

N

- Neutral sensor, 193
- Node
 - CubicleBUS, 20
- Number of poles, 181

O

- Open Source Software, 9
 - Use, 9
- Operator controls
 - TD400, 88

P

- Parameter formats, 34
 - Daylight saving time/standard time, 44
- Parameter set A, 29
- Parameter set B, 29
- Parameters
 - Circuit breaker, (Primary protection function), (Enhanced protection function), (Threshold alarms), 109
 - SNTP, 42
 - White list, 34
 - ZSI, 194
- Part number of circuit breaker, 180
- Phase loss sensitivity, 190
- Phase number, 191
- Port list, 31
- Position in the guide frame, 178
- powerconfig, 26
 - COM35, 38
 - Firmware update, 38
 - System time, 40
- PROFINET
 - Addressing I&M data sets, 67
 - Control bytes, 61
 - Data sets, 66
 - Factory setting, 38
 - I&M device identification, 66
 - Metered values, 54
 - Module, 57, 59, 62
 - Property byte, 65
 - Status information, 60
- PROFINET IO, 51
- PROFINET module
 - Technical data, 53
- Property Bytes
 - Format, 170

R

- Reference documents, 7
- Requirement Trips, 191
- Requirement Warnings, 192
- Requirements
 - 7KN Powercenter 3000, 91
 - Daylight saving time/standard time, 43
 - DSP800, 84
 - IP white list, 33
 - SNTP, 41
 - TD400, 86

S

- Security function, 31
- Security functions, 8, 30
- Setting values
 - 7KN Powercenter 3000, 91
 - Daylight saving time/standard time, 44
 - DSP800, 84
 - IP white list, 33
 - SNTP, 42
 - TD400, 87
- Siemens Industry Online Support, 39
- SlotNumber, 72
- SNTP
 - Data points, 42
 - Parameters, 42
 - Requirements, 41
 - Setting values, 42
- Standard
 - Format, 169
- Standards
 - COM35, 51
 - DAS, 26
- Status information, 60
- Status of the circuit breaker, 189
- Storage, 201
- SubmoduleIdentNumber, 72
- SubslotNumber, 72
- Switch position DI, 182
- Switched-off I2t values, 181
- System time, 40, 40
 - powerconfig, 40

T

- Table
 - White list, 35
- Target readership, 7
- TCP port, 35
- TD400
 - 3WL accessories, 85
 - Batteries, 90
 - Bluetooth, 89
 - Interfaces, 88
 - LEDs, 89
 - Magnetic rear, 89
 - Operator controls, 88
 - Requirements, 86
 - Setting values, 87
 - Technical data, 87
 - USB, 89

- Technical data
 - 7KN Powercenter 3000, 92
 - COM35, 14
 - DSP800, 84
 - PROFINET module, 53
 - TD400, 87
- Technical Support, 7
- Temporary protection
 - Write protection, 23
- Terminal strip connection, 20
- Thermal memory, 190
- Threshold alarms, 187
- Time
 - Format, 171
- Time synchronization, 40, 40
- Training, 8, 8
 - Learning paths, 8
 - WBT, 8
- Transport, 201
- Trip log, 47, 174
- Trip unit type, 193
- Trips by the extended protective functions (metering), 187
- Troubleshooting, 199
- Type of metering function, 186

U

- Units, 95
- unsigned char
 - Format, 170
- unsigned int
 - Format, 170
- unsigned long
 - Format, 170
- Update
 - Firmware, 36
- USB
 - TD400, 89
- UserStructIdentifier, 78
- UserStructureIdentifier, 73

V

- Voltage transformers, 186

W

- WBT
 - Training, 8
- WBT – web-based training, 8

- White list
 - Format, 195
 - Parameters, 34
 - Table, 35
- Write protection, 173
 - Approved modifications, 21
 - Locked modifications, 21
 - Temporary protection, 23

Further Information

Always at your disposal: our extensive support
www.siemens.com/online-support

Siemens AG
Smart Infrastructure
Low Voltage Products
Postfach 10 09 53
93009 REGENSBURG
Germany

Subject to change.
© Siemens AG 2019

