

SIEMENS



Operating Instructions

SINAMICS/SIMOTICS

Servo drive system
SINAMICS S210

SINAMICS S210 converter
SIMOTICS S-1FK2 servomotor

Edition

01/2019

www.siemens.com/drives

SIEMENS

SINAMICS/SIMOTICS

SINAMICS S210 servo drive system

Operating Instructions

Firmware V5.2

01/2019
A5E41702836B AC

Preface	
Fundamental safety instructions	1
Description	2
Configuring	3
Safety functions integrated in the drive	4
Installing	5
Commissioning and diagnostics using the web server	6
Series commissioning	7
Diagnostics	8
Service and maintenance	9
Technical specifications	10
Dimension drawings	11
Decommissioning and disposal	12
Ordering data	13
Parameters	14
Faults and alarms	15
Appendix	A

Legal information

Warning notice system

This manual contains notices you have to observe in order to ensure your personal safety, as well as to prevent damage to property. The notices referring to your personal safety are highlighted in the manual by a safety alert symbol, notices referring only to property damage have no safety alert symbol. These notices shown below are graded according to the degree of danger.

 DANGER

indicates that death or severe personal injury will result if proper precautions are not taken.
--

 WARNING
--

indicates that death or severe personal injury may result if proper precautions are not taken.

 CAUTION
--

indicates that minor personal injury can result if proper precautions are not taken.
--

NOTICE

indicates that property damage can result if proper precautions are not taken.
--

If more than one degree of danger is present, the warning notice representing the highest degree of danger will be used. A notice warning of injury to persons with a safety alert symbol may also include a warning relating to property damage.

Qualified Personnel

The product/system described in this documentation may be operated only by **personnel qualified** for the specific task in accordance with the relevant documentation, in particular its warning notices and safety instructions. Qualified personnel are those who, based on their training and experience, are capable of identifying risks and avoiding potential hazards when working with these products/systems.

Proper use of Siemens products

Note the following:

 WARNING
--

Siemens products may only be used for the applications described in the catalog and in the relevant technical documentation. If products and components from other manufacturers are used, these must be recommended or approved by Siemens. Proper transport, storage, installation, assembly, commissioning, operation and maintenance are required to ensure that the products operate safely and without any problems. The permissible ambient conditions must be complied with. The information in the relevant documentation must be observed.
--

Trademarks

All names identified by ® are registered trademarks of Siemens AG. The remaining trademarks in this publication may be trademarks whose use by third parties for their own purposes could violate the rights of the owner.

Disclaimer of Liability

We have reviewed the contents of this publication to ensure consistency with the hardware and software described. Since variance cannot be precluded entirely, we cannot guarantee full consistency. However, the information in this publication is reviewed regularly and any necessary corrections are included in subsequent editions.

Preface

Changes in version 5.2 with respect to 5.1 SP1

With version 5.2, in addition to new converters and motors, the drive system can now also be commissioned using Startdrive.

The new features are listed below.

New converters

New frame sizes FSA ... FSC for 3 AC 400 V with a power range from 0.4 kW ... 7 kW

Permissible line supply voltages: 3 AC 200 V ... 3 AC 480 V

Integrated line filter for the second environment, Category C3

New motors

1FK2 motors for 3 AC 400 V in the following versions:

- High Dynamic 1FK2104 ... 1FK2106
- Compact 1FK2204 ... 1FK2210

Keeping the documentation safe

This documentation should be kept in a location where it can be easily accessed. Make the documentation available to the personnel responsible.

Target group

These operating instructions are intended for persons who perform different tasks in the drive environment, e.g. for:

- Planning engineers
- Project engineers
- Machine manufacturers
- Commissioning engineers
- Electricians
- Installation personnel
- Service technician
- Warehouse personnel

More information

Information on the following topics is available at:

- Ordering documentation / overview of documentation
- Additional links to download documents
- Using documentation online (find and search in manuals / information)

Additional information on drive technology (<https://support.industry.siemens.com/cs/de/en/ps/13204>)

If you have any questions relating to the technical documentation (e.g. suggestions, corrections) then please email them to the following address: Email (<mailto:docu.motioncontrol@siemens.com>)

My support

Information on how to produce individual contents for your own machine documentation based on Siemens contents is available under the link:

My support (<https://support.industry.siemens.com/My/de/en/documentation>)

Note

If you want to use this function, you must register once.

Later, you can log on with your login data.

Technical Support

Country-specific telephone numbers for technical support are provided on the Internet under Contact:

Technical Support (<https://support.industry.siemens.com>)

Websites of third parties

This publication contains hyperlinks to websites of third parties. Siemens does not take any responsibility for the contents of these websites or adopt any of these websites or their contents as their own, because Siemens does not control the information on these websites and is also not responsible for the contents and information provided there. Use of these websites is at the risk of the person doing so.

Use of OpenSSL

This product contains software (<https://www.openssl.org/>) that has been developed by the OpenSSL project for use in the OpenSSL toolkit.

This product contains cryptographic software (<mailto:eay@cryptsoft.com>) created by Eric Young.

This product contains software (<mailto:eay@cryptsoft.com>) developed by Eric Young.

Compliance with the General Data Protection Regulation

Siemens respects the principles of data protection, in particular the data minimization rules (privacy by design).

For this product, this means:

The product does not process neither store any person-related data, only technical function data (e.g. time stamps). If the user links these data with other data (e.g. shift plans) or if he stores person-related data on the same data medium (e.g. hard disk), thus personalizing these data, he has to ensure compliance with the applicable data protection stipulations.

Table of contents

	Preface	3
1	Fundamental safety instructions	15
1.1	General safety instructions	15
1.2	Equipment damage due to electric fields or electrostatic discharge	22
1.3	Warranty and liability for application examples	23
1.4	Industrial security	24
1.5	Residual risks of power drive systems	26
1.6	Fundamental safety instructions for Safety Integrated	27
2	Description	29
2.1	System overview	30
2.2	The scope of supply for the system components	33
2.3	Motor	35
2.3.1	Data on the rating plate	37
2.4	Converter	38
2.5	Connection systems	43
2.6	Motor-converter combinations	44
3	Configuring	47
3.1	EMC-compliant installation of a machine or system	47
3.1.1	Control cabinet	47
3.1.2	Cables	48
3.1.3	Electromechanical components	50
3.2	Permissible line supplies and connection options	51
3.2.1	Connecting options for converters with 1 AC line connection	52
3.2.2	Connecting options for converters with 3 AC line connection	55
3.3	Configuring the motor	58
3.3.1	Configuration sequence	58
3.3.1.1	Clarify the drive type	59
3.3.1.2	Define the boundary conditions and incorporate them into the automation system	59
3.3.1.3	Define the load case, calculate the maximum load torque and determine the motor	59
3.4	Configuring the braking resistor	65
3.4.1	Calculating the braking energy	66
3.4.2	Requirements placed on the external braking resistor	67
3.4.3	Connecting an external braking resistor	69
3.5	DC link coupling	70
3.6	Application examples	72

3.7	Establishing communication of the converter with the controller	73
3.8	Functions that require a license	74
4	Safety functions integrated in the drive	75
4.1	Basic Functions	76
4.1.1	Safe Torque Off (STO)	77
4.1.2	Safe Stop 1 (SS1, time-controlled)	80
4.1.3	Safe Brake Control (SBC)	84
4.2	Extended Functions	87
4.2.1	Safe Torque Off (STO)	88
4.2.2	Safe Brake Control (SBC)	88
4.2.3	Safe Stop 1 (SS1)	88
4.2.3.1	Safe Stop 1 with acceleration monitoring (SS1-a)	89
4.2.3.2	Safe Stop 1 with braking ramp monitoring (SS1-r)	91
4.2.4	Safe Stop 2 (SS2)	93
4.2.4.1	SS2 with acceleration monitoring (SS2-a)	94
4.2.4.2	SS2 with braking ramp monitoring (SS2-r)	96
4.2.5	Safe Operating Stop (SOS)	97
4.2.6	Safely-Limited Speed (SLS)	99
4.2.6.1	SLS with a speed level	100
4.2.6.2	SLS with switchover of speed levels	101
4.2.6.3	SLS with variable speed limit value	103
4.2.6.4	Additional functional features	104
4.2.7	Safe Speed Monitor (SSM)	105
4.2.8	Safe Direction (SDI)	106
4.2.9	Safely-Limited Acceleration (SLA)	108
4.2.10	Safe Brake Test (SBT)	110
4.2.11	Safe Acceleration Monitor (SAM)	113
4.2.12	Safe Brake Ramp (SBR)	115
4.3	Configuring safety functions	118
4.4	Responses to safety faults and alarms	119
4.4.1	Discrepancy at the inputs of the F-DI	120
4.4.2	Acknowledging alarms and/or faults and switching on the motor again	122
4.5	Response times	123
4.5.1	Reaction times of Safety Integrated Basic Functions	123
4.5.1.1	Control of the Safety Integrated Basic Functions via terminals	123
4.5.1.2	Control of the Safety Integrated Basic Functions via PROFIsafe	125
4.5.2	Response times of Safety Integrated Extended Functions	126
4.5.2.1	Controlling Safety Integrated Extended Functions via PROFIsafe	126
4.6	Acceptance - completion of commissioning	127
4.6.1	Acceptance tests – Basic Functions	129
4.6.1.1	STO acceptance test	129
4.6.1.2	Acceptance test SS1	131
4.6.1.3	SBC acceptance test	132
4.6.2	Acceptance tests Extended Functions	132
4.7	Information pertaining to component replacements	133
4.8	Functional safety	136

4.9	Machinery Directive.....	137
5	Installing	139
5.1	Safety instructions.....	139
5.2	Installing the motor.....	140
5.2.1	Checklists prior to assembly	140
5.2.2	Mounting instructions for the motor.....	141
5.2.3	Attaching the output elements.....	142
5.3	Installing the converter	144
5.3.1	Installation conditions.....	144
5.3.2	Dimensions and drilling dimensions.....	146
5.4	Connecting the converter and the motor.....	148
5.4.1	Cable lengths	148
5.4.2	Connecting a MOTION-CONNECT cable at the motor.....	150
5.4.3	Connecting the converter	155
5.4.4	Converters with 1 AC line connection	159
5.4.4.1	Connecting the MOTION-CONNECT cable to the converter.....	159
5.4.4.2	Connecting the converter to the line supply	161
5.4.4.3	Connecting an external braking resistor.....	162
5.4.5	Converter with 3 AC line connection	163
5.4.5.1	Connecting the MOTION-CONNECT cable to the converter.....	163
5.4.5.2	Connecting the converter to the line supply	165
5.4.5.3	DC link cabling	167
5.4.5.4	Connecting the line cabling and DC link coupling.....	168
5.4.5.5	Connecting an external braking resistor.....	170
5.4.6	Additional connections at 1 AC / 3 AC converters	171
5.4.6.1	Connecting digital inputs and the external 24 V supply	171
5.4.6.2	Connecting service interface and PROFINET.....	173
5.4.7	Connection example	174
5.4.8	Connection example of the Failsafe Digital Input.....	176
6	Commissioning and diagnostics using the web server.....	177
6.1	Fundamentals	178
6.1.1	Accessing the web server	178
6.1.2	Users and access rights.....	179
6.1.3	Dialog screen forms in the web server.....	181
6.1.4	Changing parameter values.....	182
6.1.5	Logging on for the first time and assigning an administrator password	183
6.1.6	Login/logout.....	186
6.1.7	Start page of the web server	188
6.1.7.1	Navigating in the web server.....	189
6.1.7.2	Calling Support information.....	190
6.1.7.3	Using the control panel	191
6.1.7.4	Saving data in a non-volatile fashion	193
6.2	Commissioning using the web server	194
6.2.1	Assigning the drive name.....	196
6.2.2	Adapting the direction of rotation of the motor	197
6.2.3	Performing One Button Tuning	198
6.2.4	Setting limits.....	201
6.2.5	Setting the brake control	202

6.2.6	Configuring digital inputs	204
6.2.7	Adapting parameters	206
6.2.7.1	Configuring the parameter list	207
6.2.7.2	Changing the parameter value	209
6.2.7.3	Filtering the parameter list	209
6.2.8	Electronic weight counterbalance for a vertical axis	210
6.3	Commissioning Safety Integrated	211
6.3.1	Overview of Safety Integrated commissioning	212
6.3.2	Commissioning Safety Integrated	215
6.3.2.1	Overview	215
6.3.2.2	Function selection	216
6.3.2.3	Commissioning Basic Functions	218
6.3.2.4	Commissioning Extended Functions	219
6.3.2.5	Commissioning the control	221
6.3.2.6	Test stop (forced checking procedure)	223
6.3.2.7	Acceptance test mode	224
6.3.2.8	Finalizing commissioning	225
6.3.2.9	Safety password	226
6.3.3	Checking existing Safety settings in the read-only mode	227
6.3.4	Changing Safety settings	229
6.3.5	Safety diagnostics	230
6.4	Diagnostic functions	232
6.4.1	Display messages	232
6.4.1.1	Filtering messages	233
6.4.2	Display drive status	234
6.4.3	Displaying communication settings	235
6.5	Backup and restore	237
6.5.1	Backing up parameters	238
6.5.2	Restoring externally backed-up parameter settings	239
6.5.3	Restoring factory settings	239
6.6	System settings in the web server	240
6.6.1	Settings	240
6.6.1.1	Setting or changing user accounts	240
6.6.1.2	Configuring the IP connection	243
6.6.1.3	Configuring the system time	245
6.6.2	Updating the firmware via the web server	246
6.6.3	Using functions that require a license	248
7	Series commissioning	253
8	Diagnostics	255
8.1	Status displays and operating elements on the converter	255
8.1.1	Status display via LEDs	256
8.2	Message classes in accordance with PROFIdrive	258
8.3	Alarms	261
8.4	Faults	262
9	Service and maintenance	263
9.1	Service and maintenance for the motor	263

9.1.1	Replacing the motor bearings	265
9.1.2	Replacing the motor	266
9.2	Service and maintenance for the converter	268
9.2.1	Converter firmware update.....	268
9.2.2	Reset converter/password - restore the state when originally delivered.....	270
9.2.3	Replacing fans - only for converters with 3 AC line connection	273
9.2.4	Replacing the converter in a spare part scenario.....	274
9.2.4.1	Replacing the converter with memory card.....	274
9.2.4.2	Replacing the converter without memory card.....	276
10	Technical specifications.....	279
10.1	Technical data and properties of the motor.....	279
10.1.1	Technical features.....	279
10.1.2	Permissible environmental conditions for the motor	280
10.1.3	Cooling	282
10.1.4	Derating factors.....	283
10.1.5	Degree of protection.....	283
10.1.6	Balancing	285
10.1.7	Vibration response	285
10.1.8	Shaft extension	286
10.1.9	Radial eccentricity, concentricity and axial eccentricity.....	287
10.1.10	Axial and radial forces.....	288
10.1.11	Available encoders.....	294
10.1.12	Brake data.....	295
10.1.13	Technical data and characteristics 1FK2 High Dynamic.....	296
10.1.13.1	1FK2102-0AG	296
10.1.13.2	1FK2102-1AG	298
10.1.13.3	1FK2103-2AG	299
10.1.13.4	1FK2103-4AG	300
10.1.13.5	1FK2104-4AK.....	301
10.1.13.6	1FK2104-5AK.....	302
10.1.14	Technical data and characteristics 1FK2 Compact.....	303
10.1.14.1	1FK2203-2AG	303
10.1.14.2	1FK2203-4AG	304
10.1.14.3	1FK2204-5AF.....	305
10.1.14.4	1FK2204-5AK.....	306
10.1.14.5	1FK2204-6AF.....	307
10.2	Technical specifications of the converter	308
10.2.1	Electromagnetic compatibility according to EN61800-3.....	310
10.2.2	Permissible ambient conditions.....	311
10.2.3	General data	313
10.2.4	Specific data of the converter with 1 AC line connection	315
10.2.5	Specific data of the converter with 3 AC line connection	316
10.3	Technical data and properties of the connection system.....	318
11	Dimension drawings	321
11.1	Dimension drawings of motor.....	321
11.2	Dimension drawings of converter.....	327

12	Decommissioning and disposal	331
13	Ordering data.....	333
13.1	Ordering data of the motor	333
13.2	Ordering data of the converter	335
13.3	Connection cables between the motor and the converter	336
13.4	Accessories.....	339
13.4.1	Memory cards	339
13.4.2	Connectors and cables for line and DC link cabling.....	340
13.4.3	PROFINET patch cable.....	341
13.4.4	External line filter.....	341
13.4.5	Cabinet bushing via mounting flange	341
13.4.6	Degree of protection kit IP65 for the motor	342
13.5	Spare parts.....	343
13.5.1	Connector set for converters with 1 AC line connection - 6SL3260-2DB00-0AA0.....	343
13.5.2	Connector set for converters with 3 AC line connection - 6SL3260-2DB10-0AA0.....	346
14	Parameters	349
14.1	Parameter overview	349
14.2	List of parameters	352
15	Faults and alarms	419
15.1	Overview of faults and alarms.....	419
15.2	List of faults and alarms	421
A	Appendix.....	539
A.1	Communication telegrams	539
A.1.1	Standard telegrams	539
A.1.2	Supplementary telegrams	541
A.1.3	PROFIsafe Telegrams	542
A.1.4	Bit assignments of the process data	542
A.1.4.1	Control word 1 and status word 1	543
A.1.4.2	Control word 2 and status word 2	543
A.1.4.3	Encoder-1 control word and encoder-1 status word	544
A.1.4.4	Safety control word 1 and safety status word 1	544
A.1.4.5	Safety control word 2 and safety status word 2	545
A.1.4.6	Safety control word 1B and safety status word 1B	546
A.1.4.7	Safety status word 2B	546
A.1.4.8	Safety control word 3B and safety status word 3B.....	547
A.1.4.9	Message word.....	547
A.2	What is the difference between the Emergency Off and Emergency Stop functions?	548
A.3	Directives and standards.....	549
A.3.1	Directives, standards and certificates for the converter	549
A.3.2	Directives, standards and certificates for the motor	550
A.4	Certifications	553
A.5	Certificates for the secure data transfer.....	554
A.5.1	Certificate standard configuration	555

A.5.2	Your own certificates	560
A.6	List of abbreviations	561
Index	565

Fundamental safety instructions

1.1 General safety instructions



WARNING

Electric shock and danger to life due to other energy sources

Touching live components can result in death or severe injury.

- Only work on electrical devices when you are qualified for this job.
- Always observe the country-specific safety rules.

Generally, the following six steps apply when establishing safety:

1. Prepare for disconnection. Notify all those who will be affected by the procedure.
2. Isolate the drive system from the power supply and take measures to prevent it being switched back on again.
3. Wait until the discharge time specified on the warning labels has elapsed.
4. Check that there is no voltage between any of the power connections, and between any of the power connections and the protective conductor connection.
5. Check whether the existing auxiliary supply circuits are de-energized.
6. Ensure that the motors cannot move.
7. Identify all other dangerous energy sources, e.g. compressed air, hydraulic systems, or water. Switch the energy sources to a safe state.
8. Check that the correct drive system is completely locked.

After you have completed the work, restore the operational readiness in the inverse sequence.



WARNING

Risk of electric shock and fire from supply networks with an excessively high impedance

Excessively low short-circuit currents can lead to the protective devices not tripping or tripping too late, and thus causing electric shock or a fire.

- In the case of a conductor-conductor or conductor-ground short-circuit, ensure that the short-circuit current at the point where the inverter is connected to the line supply at least meets the minimum requirements for the response of the protective device used.
- You must use an additional residual-current device (RCD) if a conductor-ground short circuit does not reach the short-circuit current required for the protective device to respond. The required short-circuit current can be too low, especially for TT supply systems.



⚠ WARNING

Risk of electric shock and fire from supply networks with an excessively low impedance

Excessively high short-circuit currents can lead to the protective devices not being able to interrupt these short-circuit currents and being destroyed, and thus causing electric shock or a fire.

- Ensure that the prospective short-circuit current at the line terminal of the inverter does not exceed the breaking capacity (SCCR or I_{cc}) of the protective device used.



⚠ WARNING

Electric shock if there is no ground connection

For missing or incorrectly implemented protective conductor connection for devices with protection class I, high voltages can be present at open, exposed parts, which when touched, can result in death or severe injury.

- Ground the device in compliance with the applicable regulations.



⚠ WARNING

Electric shock due to connection to an unsuitable power supply

When equipment is connected to an unsuitable power supply, exposed components may carry a hazardous voltage that might result in serious injury or death.

- Only use power supplies that provide SELV (Safety Extra Low Voltage) or PELV- (Protective Extra Low Voltage) output voltages for all connections and terminals of the electronics modules.



⚠ WARNING

Electric shock due to damaged motors or devices

Improper handling of motors or devices can damage them.

Hazardous voltages can be present at the enclosure or at exposed components on damaged motors or devices.

- Ensure compliance with the limit values specified in the technical data during transport, storage and operation.
- Do not use any damaged motors or devices.

**⚠ WARNING****Electric shock due to unconnected cable shields**

Hazardous touch voltages can occur through capacitive cross-coupling due to unconnected cable shields.

- As a minimum, connect cable shields and the cores of cables that are not used at one end at the grounded housing potential.

**⚠ WARNING****Arcing when a plug connection is opened during operation**

Opening a plug connection when a system is operation can result in arcing that may cause serious injury or death.

- Only open plug connections when the equipment is in a voltage-free state, unless it has been explicitly stated that they can be opened in operation.

**⚠ WARNING****Electric shock due to residual charges in power components**

Because of the capacitors, a hazardous voltage is present for up to 5 minutes after the power supply has been switched off. Contact with live parts can result in death or serious injury.

- Wait for 5 minutes before you check that the unit really is in a no-voltage condition and start work.

⚠ WARNING**Spread of fire from built-in devices**

In the event of fire outbreak, the enclosures of built-in devices cannot prevent the escape of fire and smoke. This can result in serious personal injury or property damage.

- Install built-in units in a suitable metal cabinet in such a way that personnel are protected against fire and smoke, or take other appropriate measures to protect personnel.
- Ensure that smoke can only escape via controlled and monitored paths.

 **WARNING**

Active implant malfunctions due to electromagnetic fields

Inverters generate electromagnetic fields (EMF) in operation. People with active implants in the immediate vicinity of this equipment are at particular risk.

- As the operator of an EMF-emitting installation, assess the individual risks of persons with active implants. The following clearances are usually adequate:
 - No clearance to closed control cabinets and shielded MOTION-CONNECT supply cables
 - Forearm length (approx. 35 cm clearance) to distributed drive systems and open control cabinets



 **WARNING**

Active implant malfunctions due to permanent-magnet fields

Even when switched off, electric motors with permanent magnets represent a potential risk for persons with heart pacemakers or implants if they are close to converters/motors.

- If you have a heart pacemaker or implant, maintain the minimum distance specified in the Chapter "Technical data".
- When transporting or storing permanent-magnet motors always use the original packing materials with the warning labels attached.
- Clearly mark the storage locations with the appropriate warning labels.
- IATA regulations must be observed when transported by air.

 **WARNING**

Unexpected movement of machines caused by radio devices or mobile phones

When radio devices or mobile phones with a transmission power > 1 W are used in the immediate vicinity of components, they may cause the equipment to malfunction. Malfunctions may impair the functional safety of machines and can therefore put people in danger or lead to property damage.

- If you come closer than around 2 m to such components, switch off any radios or mobile phones.
- Use the "SIEMENS Industry Online Support app" only on equipment that has already been switched off.

NOTICE**Damage to motor insulation due to excessive voltages**

When operated on systems with grounded line conductor or in the event of a ground fault in the IT system, the motor insulation can be damaged by the higher voltage to ground. If you use motors that have insulation that is not designed for operation with grounded line conductors, you must perform the following measures:

- IT system: Use a ground fault monitor and eliminate the fault as quickly as possible.
- TN or TT systems with grounded line conductor: Use an isolating transformer on the line side.

 **WARNING****Fire due to inadequate ventilation clearances**

Inadequate ventilation clearances can cause overheating of components with subsequent fire and smoke. This can cause severe injury or even death. This can also result in increased downtime and reduced service lives for devices/systems.

- Ensure compliance with the specified minimum clearance as ventilation clearance for the respective component.

 **WARNING****Unrecognized dangers due to missing or illegible warning labels**

Dangers might not be recognized if warning labels are missing or illegible. Unrecognized dangers may cause accidents resulting in serious injury or death.

- Check that the warning labels are complete based on the documentation.
- Attach any missing warning labels to the components, where necessary in the national language.
- Replace illegible warning labels.

NOTICE**Device damage caused by incorrect voltage/insulation tests**

Incorrect voltage/insulation tests can damage the device.

- Before carrying out a voltage/insulation check of the system/machine, disconnect the devices as all converters and motors have been subject to a high voltage test by the manufacturer, and therefore it is not necessary to perform an additional test within the system/machine.

 **WARNING**

Unexpected movement of machines caused by inactive safety functions

Inactive or non-adapted safety functions can trigger unexpected machine movements that may result in serious injury or death.

- Observe the information in the appropriate product documentation before commissioning.
- Carry out a safety inspection for functions relevant to safety on the entire system, including all safety-related components.
- Ensure that the safety functions used in your drives and automation tasks are adjusted and activated through appropriate parameterizing.
- Perform a function test.
- Only put your plant into live operation once you have guaranteed that the functions relevant to safety are running correctly.

 **WARNING**

Malfunctions of the machine as a result of incorrect or changed parameter settings

As a result of incorrect or changed parameterization, machines can malfunction, which in turn can lead to injuries or death.

- Protect the parameterization (parameter assignments) against unauthorized access.
- Handle possible malfunctions by taking suitable measures, e.g. emergency stop or emergency off.

 **WARNING**

Injury caused by moving or ejected parts

Contact with moving motor parts or drive output elements and the ejection of loose motor parts (e.g. feather keys) out of the motor enclosure can result in severe injury or death.

- Remove any loose parts or secure them so that they cannot be flung out.
- Do not touch any moving parts.
- Safeguard all moving parts using the appropriate safety guards.

 **WARNING**

Fire due to inadequate cooling

Inadequate cooling can cause the motor to overheat, resulting in death or severe injury as a result of smoke and fire. This can also result in increased failures and reduced service lives of motors.

- Comply with the specified cooling requirements for the motor.

 **WARNING****Fire due to incorrect operation of the motor**

When incorrectly operated and in the case of a fault, the motor can overheat resulting in fire and smoke. This can result in severe injury or death. Further, excessively high temperatures destroy motor components and result in increased failures as well as shorter service lives of motors.

- Operate the motor according to the relevant specifications.
- Only operate the motors in conjunction with effective temperature monitoring.
- Immediately switch off the motor if excessively high temperatures occur.

 **CAUTION****Burn injuries caused by hot surfaces**

In operation, the motor can reach high temperatures, which can cause burns if touched.

- Mount the motor so that it is not accessible in operation.

Measures when maintenance is required:

- Allow the motor to cool down before starting any work.
- Use the appropriate personnel protection equipment, e.g. gloves.

1.2 Equipment damage due to electric fields or electrostatic discharge

Electrostatic sensitive devices (ESD) are individual components, integrated circuits, modules or devices that may be damaged by either electric fields or electrostatic discharge.



NOTICE

Equipment damage due to electric fields or electrostatic discharge

Electric fields or electrostatic discharge can cause malfunctions through damaged individual components, integrated circuits, modules or devices.

- Only pack, store, transport and send electronic components, modules or devices in their original packaging or in other suitable materials, e.g. conductive foam rubber or aluminum foil.
- Only touch components, modules and devices when you are grounded by one of the following methods:
 - Wearing an ESD wrist strap
 - Wearing ESD shoes or ESD grounding straps in ESD areas with conductive flooring
- Only place electronic components, modules or devices on conductive surfaces (table with ESD surface, conductive ESD foam, ESD packaging, ESD transport container).

1.3 Warranty and liability for application examples

Application examples are not binding and do not claim to be complete regarding configuration, equipment or any eventuality which may arise. Application examples do not represent specific customer solutions, but are only intended to provide support for typical tasks.

As the user you yourself are responsible for ensuring that the products described are operated correctly. Application examples do not relieve you of your responsibility for safe handling when using, installing, operating and maintaining the equipment.

1.4 Industrial security

Note

Industrial security

Siemens provides products and solutions with industrial security functions that support the secure operation of plants, systems, machines and networks.

In order to protect plants, systems, machines and networks against cyber threats, it is necessary to implement – and continuously maintain – a holistic, state-of-the-art industrial security concept. Siemens' products and solutions constitute one element of such a concept.

Customers are responsible for preventing unauthorized access to their plants, systems, machines and networks. Such systems, machines and components should only be connected to an enterprise network or the Internet if and to the extent such a connection is necessary and only when appropriate security measures (e.g. firewalls and/or network segmentation) are in place.

For additional information on industrial security measures that may be implemented, please visit:

Industrial Security (<http://www.siemens.com/industrialsecurity>)

Siemens' products and solutions undergo continuous development to make them more secure. Siemens strongly recommends that product updates are applied as soon as they are available and that the latest product versions are used. Use of product versions that are no longer supported, and failure to apply the latest updates may increase customer's exposure to cyber threats.

To stay informed about product updates, subscribe to the Siemens Industrial Security RSS Feed at:

Industrial Security (<http://www.siemens.com/industrialsecurity>)

Further information is provided on the Internet:

Industrial Security Configuration Manual (<https://support.industry.siemens.com/cs/ww/en/view/108862708>)

 **WARNING****Unsafe operating states resulting from software manipulation**

Software manipulations (e.g. viruses, trojans, malware or worms) can cause unsafe operating states in your system that may lead to death, serious injury, and property damage.

- Keep the software up to date.
- Incorporate the automation and drive components into a holistic, state-of-the-art industrial security concept for the installation or machine.
- Make sure that you include all installed products into the holistic industrial security concept.
- Protect files stored on exchangeable storage media from malicious software by with suitable protection measures, e.g. virus scanners.
- Protect the drive against unauthorized changes by activating the "know-how protection" drive function.

1.5 Residual risks of power drive systems

When assessing the machine- or system-related risk in accordance with the respective local regulations (e.g., EC Machinery Directive), the machine manufacturer or system installer must take into account the following residual risks emanating from the control and drive components of a drive system:

1. Unintentional movements of driven machine or system components during commissioning, operation, maintenance, and repairs caused by, for example,
 - Hardware and/or software errors in the sensors, control system, actuators, and cables and connections
 - Response times of the control system and of the drive
 - Operation and/or environmental conditions outside the specification
 - Condensation/conductive contamination
 - Parameterization, programming, cabling, and installation errors
 - Use of wireless devices/mobile phones in the immediate vicinity of electronic components
 - External influences/damage
 - X-ray, ionizing radiation and cosmic radiation
2. Unusually high temperatures, including open flames, as well as emissions of light, noise, particles, gases, etc., can occur inside and outside the components under fault conditions caused by, for example:
 - Component failure
 - Software errors
 - Operation and/or environmental conditions outside the specification
 - External influences/damage
3. Hazardous shock voltages caused by, for example:
 - Component failure
 - Influence during electrostatic charging
 - Induction of voltages in moving motors
 - Operation and/or environmental conditions outside the specification
 - Condensation/conductive contamination
 - External influences/damage
4. Electrical, magnetic and electromagnetic fields generated in operation that can pose a risk to people with a pacemaker, implants or metal replacement joints, etc., if they are too close
5. Release of environmental pollutants or emissions as a result of improper operation of the system and/or failure to dispose of components safely and correctly
6. Influence of network-connected communication systems, e.g. ripple-control transmitters or data communication via the network

For more information about the residual risks of the drive system components, see the relevant sections in the technical user documentation.

1.6 Fundamental safety instructions for Safety Integrated

Additional safety instructions and residual risks

Additional safety information and residual risks not specified in this section are included in the relevant sections of this Function Manual.

DANGER

Risk minimization through Safety Integrated

Safety Integrated can be used to minimize the level of risk associated with machines and plants.

Machines and plants can only be operated safely in conjunction with Safety Integrated, however, when the machine manufacturer:

- Precisely knows and observes this technical user documentation - including the documented limitations, safety information and residual risks.
- Carefully constructs and configures the machine/plant. A careful and thorough acceptance test must then be performed by qualified personnel and the results documented.
- Implements and validates all the measures required in accordance with the machine/plant risk analysis by means of the programmed and configured Safety Integrated Functions or by other means.

The use of Safety Integrated does not replace the machine/plant risk assessment carried out by the machine manufacturer as required by the EC machinery directive.

In addition to using Safety Integrated Functions, further risk reduction measures must be implemented.

NOTICE

Danger to life as a result of inactive Safety Integrated Functions after powering up

The Safety Integrated Functions are only activated after the system has completely powered up. System startup is a critical operating state with increased risk. When accidents occur, this can result in death or severe injury.

- Make sure that the machine is safe during the system start-up.

WARNING

Danger to life as a result of undesirable motor movement when automatically restarting

The Emergency Stop function must bring the machine to a standstill according to Stop Category 0 or 1 (STO or SS1) (EN 60204-1).

It is not permissible that the motor automatically restarts after an Emergency Stop, as this represents danger to life as a result of the associated undesirable motor motion.

When individual safety functions (Extended Functions) are deactivated, an automatic restart is permitted under certain circumstances depending on the risk analysis (except when Emergency Stop is reset). An automatic start is permitted when a protective door is closed, for example.

- For the cases listed above, ensure that an automatic restart is absolutely not possible.

 **WARNING**

Danger to life as a result of undesirable motor motion when the system powers up and the drives are activated after changing or replacing hardware and/or software

After hardware and/or software components have been modified or replaced, it is only permissible for the system to run up and the drive to be activated with the protective devices closed. Personnel shall not be present within the danger zone.

- It may be necessary to carry out a partial or complete acceptance test or a simplified functional test after having made certain changes or replacements.
- Before personnel may re-enter the hazardous area, all of the drives should be tested to ensure that they exhibit stable control behavior by briefly moving them in both the plus and minus directions (+/-).
- **When switching on carefully observed the following:**
The Safety Integrated Functions are only available and can only be selected after the system has completely powered up.

 **WARNING**

Converter operation despite active messages

With activated safety functions, there are a number of system messages that still permit the drive to be traversed. In these cases, you must ensure that the causes of the messages are corrected immediately. Example:

- F13000 licensing is insufficient
Purchase the license required for operation of the Extended Functions or activate a Trial License.

Description

The components described in this manual – motor, converter and associated connection cables – are optimally tailored to one another and thereby facilitate the installation and commissioning in a few steps.

The commissioning and diagnostics are performed with a PC or notebook (commissioning device) via the web server integrated in the converter. A separate commissioning program or diagnostics tool is not required.

Correct usage

The components are intended for industrial and commercial use in industrial networks.

The motor is only approved for operation with a converter.

Typical applications

- Robots and handling systems
- Packaging, plastics and textile machines
- Wood, glass, ceramics and stone working machines
- Printing machines

2.1 System overview

The drive system comprises the following system components tailored to one another:

- SINAMICS S210 converter
- SIMOTICS S-1FK2 motor
- OCC MOTION-CONNECT cable

The converter and the motor are optimally tailored to one another and are intended for use with a higher-level controller (PLC). Connection to the controller is via PROFINET:

Prefabricated MOTION-CONNECT cables in various lengths are available to simply connect the motor to the converter and to ensure safe and reliable operation.

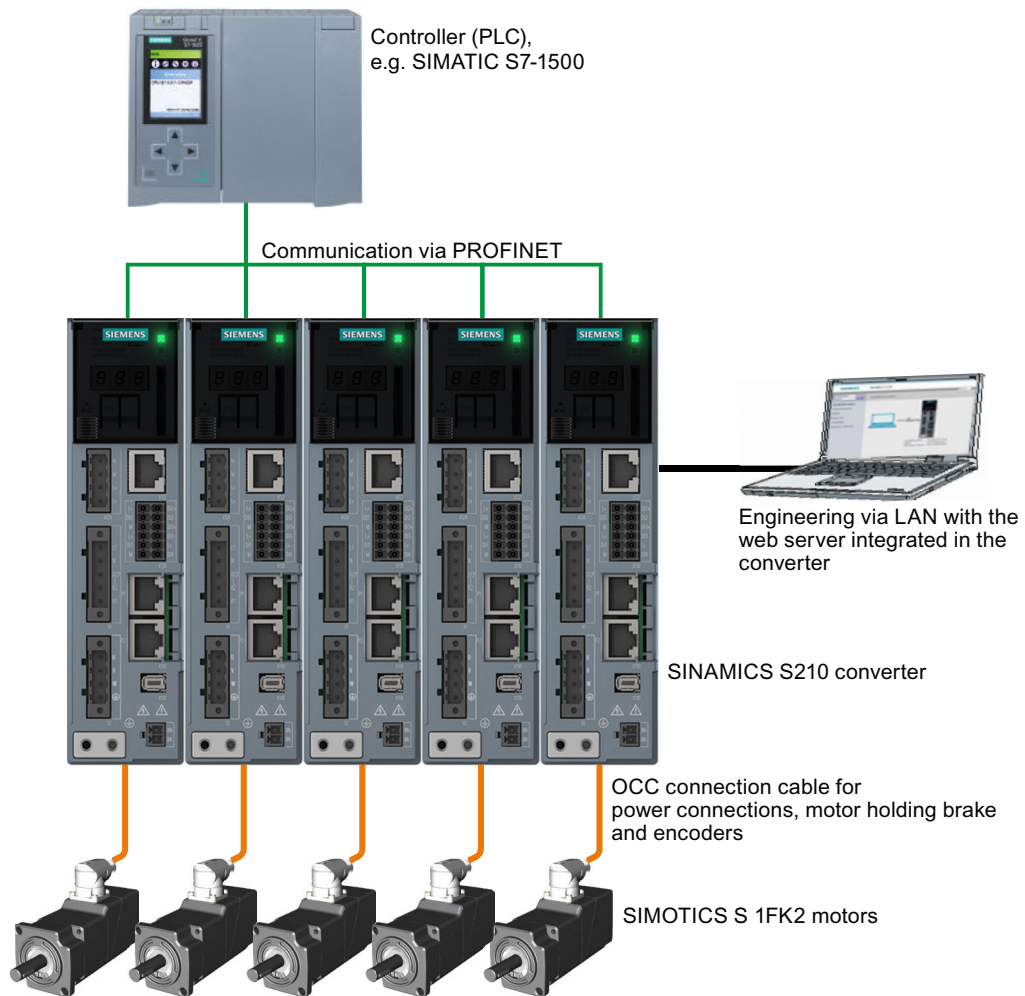

Figure 2-1 System

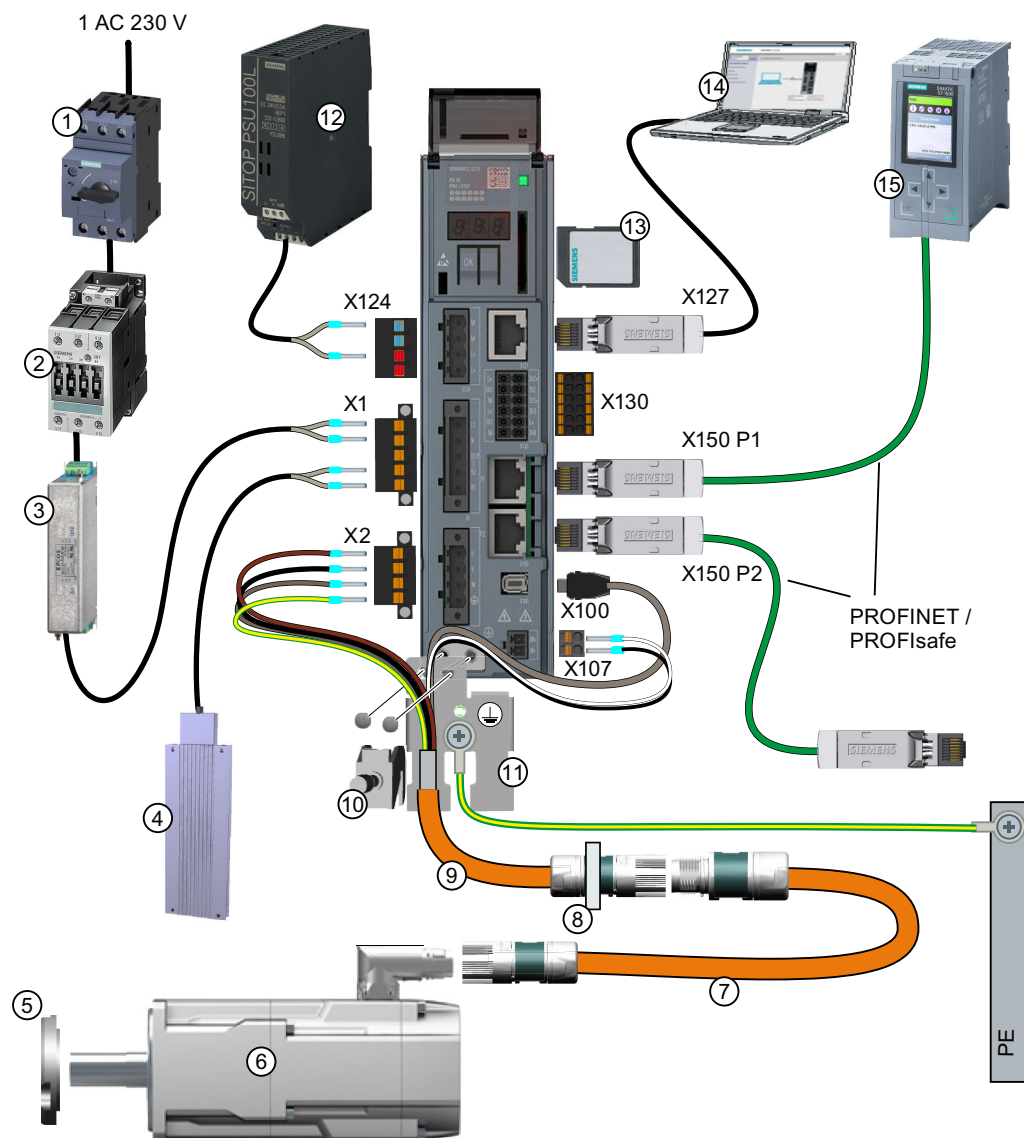

Figure 2-2 System components and accessories for converters with 1 AC line connection

- | | |
|--|---|
| ① Fuse or circuit breaker | ⑨ OCC connection cable for motor, motor holding brake and encoder |
| ② Line contactor (optional) | ⑩ Shield clamp |
| ③ Line filter (optional) | ⑪ Shield plate |
| ④ External braking resistor (optional) | ⑫ 24 V power supply |
| ⑤ Shaft sealing ring for IP65 (optional) | ⑬ SD memory card (optional) |
| ⑥ 1FK2 servomotor | ⑭ Commissioning device |
| ⑦ OCC extension cable (optional) | ⑮ Controller, e.g. SIMATIC S7-1500 |
| ⑧ Mounting flange for control cabinet bushing (optional) | ⑯ X1: Connector for line cabling - option |
| | ⑰ X3: Connector for DC link cabling - option |

2.2 The scope of supply for the system components

You must order the components individually.

Motor

Included in the scope of supply:

- A "Safety instructions" sheet
- A sheet referencing links to product information
- A second rating plate

Converter

The components listed below are included in the scope of delivery:

For all converters:

- A "Safety instructions" sheet
- The Quick Installation Guide (English)
- A warning label for affixing in the control cabinet
- X2: Connector for motor connection
- X107: Connector for motor holding brake
- X124: Connector for 24 V DC supply voltage
- X130: Connector for digital inputs

For converters with 1 AC line connection

- Shield plate
- X1: Connector for line connection and external braking resistor (jumper for internal braking resistor is included)

For converters with 3 AC line connection

- For FSA, FSB and FSC, the shield connection is integrated in the converter itself.
- X1: Connector for line connection
- X4: Connector for external braking resistor (jumper for internal braking resistor is included)

Note

All connectors are designed so that they cannot be inadvertently interchanged.

MOTION-CONNECT cable (OCC cable)

The scope of supply for the prefabricated MOTION-CONNECT cables includes:

- The MOTION-CONNECT cable with assembled connectors for connecting to motors and encoders
- A shield clamp for the connection of the shield to the shield plate of the converter
- A safety data sheet

Details on the OCC MOTION-CONNECT cables can be found in the following Section:



Connection cables between the motor and the converter (Page 336).

Optional accessories

The optional accessories are listed in the following Section:



Accessories (Page 339).

2.3 Motor

The SIMOTICS S-1FK2, called "1FK2" in the following, is a permanent-magnet compact synchronous motor with an integrated encoder and a high degree of protection.

The 1FK2 meets the requirements of standards EN 60034 and EN 60204-1 - and complies with the Low-Voltage Directive 2014/35/EU.

 WARNING
Malfunction of active implants due to magnetic and electrical fields
Electric motors pose a danger to people with active medical implants, e.g. heart pacemakers, who come close to these motors.
<ul style="list-style-type: none"> • If you are affected, stay a minimum distance of 300 mm from the motors (tripping threshold for static magnetic fields of 0.5 mT according to Directive 2013/35/EU).

Dynamic versions

- 1FK21 "High Dynamic" with low moment of inertia for a maximum acceleration capability in applications involving low load moments of inertia
- 1FK22 "Compact" with average moment of inertia and precise positioning and synchronous operation characteristics for applications with a high and variable load moment of inertia

Torque range

- 0.16 Nm ... 2.4 Nm for a 230 V 1 AC line supply
- 1.3 Nm ... 40 Nm for a 3 AC 400 V line supply

Degree of protection

- IP64
- IP65 with a radial shaft sealing ring to protect against spray water

For additional information on the degree of protection, see Chapter:

 **"Degree of protection (Page 283)"**

Cooling

The 1FK2 is a non-ventilated motor.

The motor thermal losses are dissipated by thermal conduction, thermal radiation and natural convection.

If the ambient temperature exceeds 40 °C (104 °F) or the installation altitude 1000 meters above sea level, you must reduce torque and power of the motor (derating).

Information on derating can be found in Chapter:

 **"Derating factors (Page 283)"**

When mounting the motor, carefully observe the specifications in Chapter:

 "Cooling (Page 282)"

Bearing version

The motors have deep groove ball bearings with life-long lubrication.

The average bearing service life is designed for 25000 operating hours.

The motors have spring-loaded bearings in the NDE direction. For version with holding brake, the NDE bearing is a locating bearing.

The permissible axial and radial forces can be found in the technical data in Chapter:

 "Axial and radial forces (Page 288)"

Shaft extension

- Cylindrical shaft without feather key
- Cylindrical shaft with feather key (half-key balancing)

For additional information, see Chapter:

 "Shaft extension (Page 286)"

Encoder

The encoder resolution is 22 bit per revolution (singleturn). An optional multiturn encoder is available that is equipped with an additional 12-bit revolution counter (traversing range of 4096 revolutions).

The encoder designations are as follows:

- AS22DQC: Absolute encoder, singleturn, 22 bit
- AM22DQC: Absolute encoder 22 bit + 12 bit multiturn

For additional information, see Chapter:

 "Available encoders (Page 294)"

Holding brake

The 1FK2 servomotor is available with integrated holding brake.

The holding brake closes in the current-free state and locks the motor shaft at a standstill. When current flows, the holding brake opens and releases the motor shaft.

SINAMICS S210 controls the holding brake without any additional devices.

The holding brake is not a working brake for braking the rotating motor. Limited EMERGENCY STOP operation is permissible.

The brake data can be found in Chapter:

 "Brake data (Page 295)"

2.3.1 Data on the rating plate

The rating plate contains the article number and the technical data of the motor.

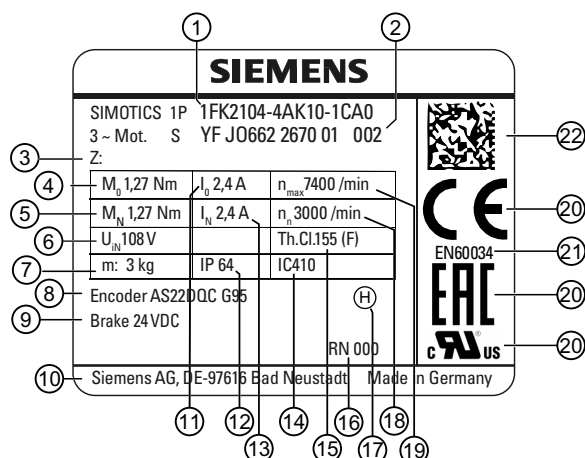

Figure 2-4 Rating plate

Position	Description / technical specifications	Position	Description / technical specifications
1	Article number	12	Degree of protection
2	ID No., serial number	13	Rated current I_{rated} / A
3	Additional options specified as a supplement to the article number	14	Cooling mode according to EN 60034-6
4	Static torque M_0 / Nm	15	Thermal class of the insulation system
5	Rated torque M_{rated} / Nm	16	Revision
6	Induced voltage at rated speed V_{IN} / V	17	Type of balancing (only for motors with feather key)
7	Motor weight m / kg	18	Rated speed n_{rated} / rpm
8	Marking of encoder type	19	Maximum speed n_{max} / rpm
9	Data of the holding brake	20	Certifications
10	Manufacturer's address	21	Standard for all rotating electrical machines
11	Stall current I_0 / A	22	Data matrix code

2.4 Converter

The converter is a single-axis device (complete converter with integrated infeed). It is characterized by a compact design, side-by-side installation and high overload capability.

It is intended for use with 1FK2 motors, and is available in the following versions:

- Line supply voltage 230 V 1 AC (200 V ... 240 V)
Power range 0.1 kW ... 0.75 kW
- Line supply voltage 230 V 3 AC and 400 V 3 AC (200 V ... 480 V)
Power range when connected to 3 AC 400 V: 0.4 kW ... 7 kW

Control mode

Servo control, optimized for 1FK2 motors

Safety functions integrated in the drive

The converter offers the following safety functions integrated in the drive:

Table 2-1 Overview of the Safety Integrated Functions

	Functions	Abbr	Brief description
Basic Functions	Safe Torque Off	STO	Safe Torque Off according to stop Category 0
	Safe Stop 1	SS1	Safe stopping process in accordance with stop category 1
	Safe Brake Control	SBC	Safe brake control
Extended Functions	Safe Torque Off	STO	Safe Torque Off according to stop Category 0
	Safe Stop 1	SS1	Safe stopping process in accordance with stop category 1
	Safe Brake Control	SBC	Safe brake control
	Safe Operating Stop	SOS	Safe monitoring of the standstill position
	Safe Stop 2	SS2	Safe stopping process in accordance with stop category 2
	Safely-Limited Speed	SLS	Safe monitoring of the maximum speed
	Safe Speed Monitor	SSM	Safe monitoring of the minimum speed
	Safe Direction	SDI	Safe monitoring of the direction of motion
	Safely-Limited Acceleration	SLA	Safely-limited acceleration
Diagnostic function Safe Brake Test	SBT	Safe test of the required holding torque of a brake	

 Safety functions integrated in the drive (Page 75)

The Basic Functions are included in the scope of delivery of the converter. The Extended Functions require a license.

 Using functions that require a license (Page 248)

Integrated braking resistor

In order to absorb the regenerative load of the motor, converters have an internal braking resistor (exception: 100 W device).

If the internal braking resistor is not sufficient, you have the option of connecting an external braking resistor.



Configuring the braking resistor (Page 65)



Connecting the converter (Page 155)

Communicating with the controller via PROFINET

The converter supports the following functions:

- RT (real time)
- IRT (isochronous real time) with the telegrams 5 and 105
- MRP (media redundancy) with RT
- MRPD (seamless media redundancy) with IRT
- Shared device
- PROFIsafe
- PROFIenergy
- Automatic telegram selection

Commissioning, diagnostics and data backup

The commissioning, diagnostics and data backup are performed using a PC or notebook (commissioning device) via the web server integrated in the converter - or using the Startdrive commissioning software.



Commissioning and diagnostics using the web server (Page 177)

Nameplate and date of manufacture - 1 AC

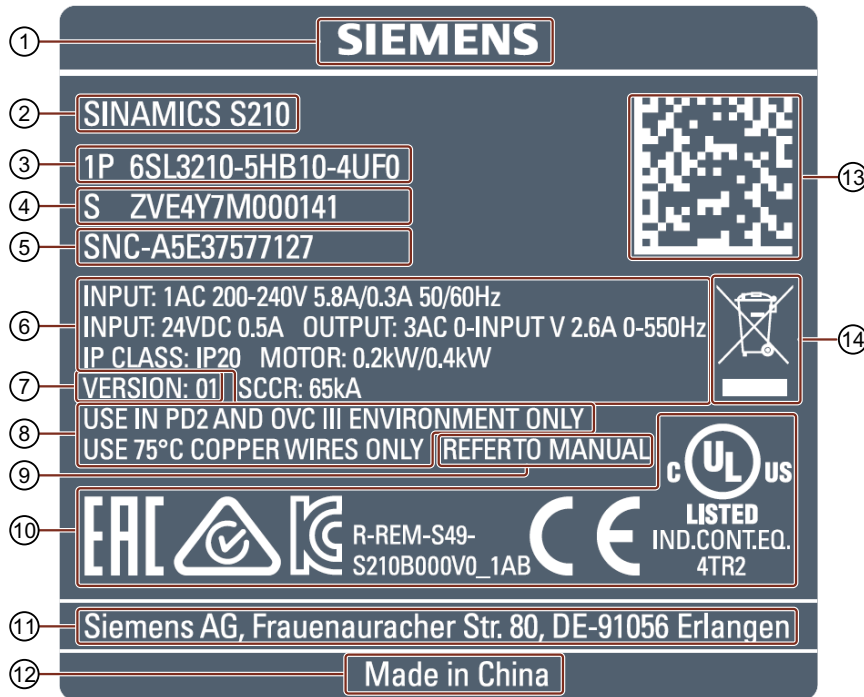

- | | |
|--|----------------------------|
| 1 Manufacturer | 8 Environmental conditions |
| 2 Product designation | 9 Reference to the manual |
| 3 Article number | 10 Certificates |
| 4 Serial number | 11 Manufacturer's address |
| 5 Material number | 12 Production location |
| 6 Electrical data and degree of protection | 13 Data matrix code |
| 7 Function release/version | 14 Note on disposal |

Date of manufacture

The date of manufacture of the converter is coded, as shown below in the serial number.

S Z V E 4 Y 7 M 0 0 0 1 4 1

Month of manufacture						
1 January	2 February	3 March	4 April	5 May	6 June	7 July
8 August	9 September	O October	N November	D December		
Year of manufacture						
E 2014	F 2015	H 2016	J 2017	K 2018	L 2019	M 2020
N 2021	P 2022	R 2023	S 2024	T 2025	U 2026	V 2027
W 2028	X 2029					

Figure 2-5 Date of manufacture (example April 2014)

Nameplate and date of manufacture - 3 AC



- | | | | |
|---|--|----|-------------------------|
| 1 | Manufacturer | 8 | Reference to the manual |
| 2 | Function status and material number | 9 | Certificates |
| 3 | Product designation | 10 | Manufacturer's address |
| 4 | Article number | 11 | Production location |
| 5 | Serial number | 12 | Data matrix code |
| 6 | Electrical data and degree of protection | 13 | Note on disposal |
| 7 | Environmental conditions | | |

Date of manufacture

The date of manufacture of the converter is coded, as shown below in the serial number.

S T - K **5** 6 1 2 3 4 5 6

Month of manufacture							
1	January	2	February	3	March	4	April
5	May	6	June	7	July	8	August
9	September	O	October	N	November	D	December
Year of manufacture							
J	2017	K	2018	L	2019	M	2020
N	2021	P	2022	R	2023	S	2024
T	2025	U	2026	V	2027	W	2028
X	2029						

Figure 2-6 Date of manufacture (example May 2018)

Information label

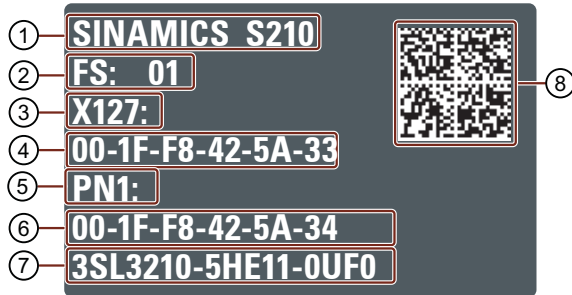

- | | |
|--|---|
| 1 Product designation | 5 PROFINET interface |
| 2 Function release/version | 6 MAC address of the PROFINET interface |
| 3 Service interface | 7 Article number |
| 4 MAC address of the service interface | 8 Data matrix code |

2.5 Connection systems

The motor is connected to the converter by a MOTION-CONNECT cable.

The cable is in one cable connection technology and called "OCC cable" in the following.

As a result of its flexibility and low diameter, it permits very tight bending radii.

The OCC cables are available in the following variants:

- MOTION-CONNECT 500
 - Cost-effective solution for mainly fixed installation
 - Suitable for low mechanical loading
- MOTION-CONNECT 800PLUS
 - Meets requirements for use in cable carriers
 - tested for horizontal movement distances up to 50 m
 - not self-supporting
 - Suitable for high mechanical loading
 - Oil-resistant

The OCC cables can be supplied in lengths by the decimeter.

Extensions and cabinet bushings are available for the OCC cables.

For additional information, see Chapter:

 "Technical data and properties of the connection system (Page 318)"

2.6 Motor-converter combinations

Converter with line connection 1 AC 200 V ... 240 V

The following table lists recommended combinations of converters connected to a 1 AC line supply and motors with the associated connecting cables.

Motor		Converter				OCC cable	
Article number (positions 1 ... 10 of the article number)	Torque M_0 / Nm	100 W	200 W	400 W	750 W	M12	M17
		Article number 6SL3210-5HB10-...				Article number 6FX . 002-...	
		...1UF0	...2UF0	...4UF0	...8UF0	...8QN04-...	...8QN08-...
High Dynamic							
1FK2102-0AG	0.16	x				x	
1FK2102-1AG	0.32	x				x	
1FK2103-2AG	0.64		x			x	
1FK2103-4AG	1.27			x		x	
1FK2104-4AK	1.27			x			x
1FK2104-5AK	2.39				x		x
Compact							
1FK2203-2AG	0.64		x			x	
1FK2203-4AG	1.27			x		x	
1FK2204-5AK	2.39				x		x

Converter with line connection 3 AC 200 V ... 240 V

Motor		Converter				OCC cable	
Article number (positions 1 ... 10 of the article number)	Torque M_0 / Nm	0.4 kW	0.75 kW	1 kW	1.5 kW	M12 connector	M17 connector
		Article number 6SL3210-5HE10-				Article number 6FX . 002-...	
		...10-4UF0	...10-8UF0	...11-0UF0	...11-5UF0	...8QN04-...	... 8QN08-...
High Dynamic							
1FK2102-0AG	0.16	x ²⁾				x	
1FK2102-1AG	0.32	x ²⁾				x	
1FK2103-2AG	0.64		x ²⁾			x	
1FK2103-4AG	1.27			x ²⁾		x	
1FK2104-4AK	1.27			x ²⁾			x
Compact							

Motor		Converter				OCC cable	
Article number (positions 1 ... 10 of the article number)	Torque M_0 / N m	0.4 kW	0.75 kW	1 kW	1.5 kW	M12 con- nector	M17 con- nector
		Article number 6SL3210-5HE10-				Article number 6FX . 002-...	
		...10-4UF0	...10-8UF0	...11-0UF0	...11-5UF0	...8QN04-...	... 8QN08-...
1FK2203-2A G	0.64	x ²⁾				x ¹⁾	
1FK2203-4A G	1.27			x ²⁾		x ¹⁾	

1) Available soon

2) Only up to max. 240 V

Converter with line connection 3 AC 380 V ... 480 V

The following table lists possible combinations of converters connected to a 3 AC line supply and motors with the associated connecting cables.

Motor		Converter								OCC cable	
Article number (positions 1 ... 10 of the ar- ticle number)	Torque M_0 / Nm	0.4 kW	0.75 k W	1 kW	1.5 kW	2 kW	3.5 kW	5 kW	7 kW	M17	M23
		Article number 6SL3210-5HE...								Article number 6FX . 002-...	
		... 10-4UF 0	... 10-8UF 0	... 11-0UF 0	... 11-5UF 0	... 12-0UF 0	... 13-5UF 0	... 15-0UF 0	... 17-0UF 0	8QN08- ...	8QN11- ...
High Dynamic											
1FK2104-4AF	1.27	x								x	
1FK2104-5AF	2.39		x							x	
1FK2104-6AF	3.18			x						x	
1FK2105-4AF ¹⁾	5 ¹⁾				x ¹⁾					x ¹⁾	
1FK2105-6AF ¹⁾	8 ¹⁾					x ¹⁾				x ¹⁾	
1FK2106-3AF ¹⁾	9 ¹⁾							x ¹⁾			x ¹⁾
1FK2106-4AF ¹⁾	12 ¹⁾								x ¹⁾		x ¹⁾
1FK2106-6AF ¹⁾	16 ¹⁾								x ¹⁾		x ¹⁾
Compact											
1FK2204-5AF	2.39		x							x	
1FK2204-6AF	3.18			x						x	
1FK2205-2AF ¹⁾	3.5 ¹⁾			x ¹⁾						x ¹⁾	
1FK2205-4AF ¹⁾	6 ¹⁾				x ¹⁾					x ¹⁾	
1FK2206-2AF ¹⁾	6 ¹⁾				x ¹⁾					x ¹⁾	
1FK2206-4AF ¹⁾	12 ¹⁾						x ¹⁾			x ¹⁾	
1FK2208-3AC ¹⁾	16 ¹⁾							x ¹⁾			x ¹⁾
1FK2208-4AC ¹⁾	22 ¹⁾							x ¹⁾			x ¹⁾

Description

2.6 Motor-converter combinations

Motor		Converter								OCC cable	
Article number (positions 1 ... 10 of the article number)	Torque M_0 / Nm	0.4 kW	0.75 kW	1 kW	1.5 kW	2 kW	3.5 kW	5 kW	7 kW	M17	M23
		Article number 6SL3210-5HE...								Article number 6FX . 002-...	
		... 10-4UF 0	... 10-8UF 0	... 11-0UF 0	... 11-5UF 0	... 12-0UF 0	... 13-5UF 0	... 15-0UF 0	... 17-0UF 0	8QN08- ...	8QN11- ...
1FK2208-5AC ¹⁾	27 ¹⁾								x ¹⁾		x ¹⁾
1FK2210-3AC ¹⁾	30 ¹⁾								x ¹⁾		x ¹⁾
1FK2210-4AC ¹⁾	40 ¹⁾								x ¹⁾		x ¹⁾

¹⁾ Available soon

Configuring

3.1 EMC-compliant installation of a machine or system

The converter is designed for operation in industrial environments.

Reliable and disturbance-free operation is only guaranteed for EMC-compliant installation.

Further information



Additional information about EMC-compliant installation is available in the Internet:

EMC installation guideline (<http://support.automation.siemens.com/WW/view/en/60612658>)

3.1.1 Control cabinet

Control cabinet assembly

- Install a shield support for shielded cables that are routed out of the control cabinet.
- Connect the PE bar and the shield support to the control cabinet frame through a large surface area to establish a good electrical connection.
- Mount the converter, the 24 V DC power supply and the optional line filter on a bare metal mounting plate.
- Connect the mounting plate to the control cabinet frame and PE bar and shield support through a large surface area to establish a good electrical connection.

Permissible protective elements and the required control cabinet sizes:



Protective devices (<https://support.industry.siemens.com/cs/ww/en/view/109748999>)

3.1.2 Cables

Cables with a high level of interference and cables with a low level of interference are connected to the converter.

Note

Cables with a high level of interference must be shielded.

- Cables with a high level of interference:
 - Cable between the line filter and converter
 - Motor cable
 - Cable between the converter and external braking resistor
- Cables with a low level of interference:
 - Cable between the line and line filter
 - Signal and data cables

Cable routing inside the cabinet

- Route the cables with a high level of interference so that there is the largest possible clearance to cables with a low level of interference.
- Cables with a high level of interference and cables with a low level of interference may only cross over at right angles:
- Keep all of the cables as short as possible.
- Route all of the cables close to the mounting plates or cabinet frames.
- Route signal and data cables - as well as the associated equipotential bonding cables - parallel and close to one another.
- Twist incoming and outgoing unshielded individual conductors.
Alternatively, you can route incoming and outgoing conductors in parallel, but close to one another.
- Ground any unused conductors of signal and data cables at both ends.
- Signal and data cables must only enter the cabinet from one side, e.g. from below.
- Use shielded cables for the following connections:
 - Cable between the converter and line filter
 - Cable between the converter and motor
 - Cable between the converter and external braking resistor
 - Signal cables if they are routed next to cables with high levels of noise and interference

Routing converter cables inside and outside a control cabinet

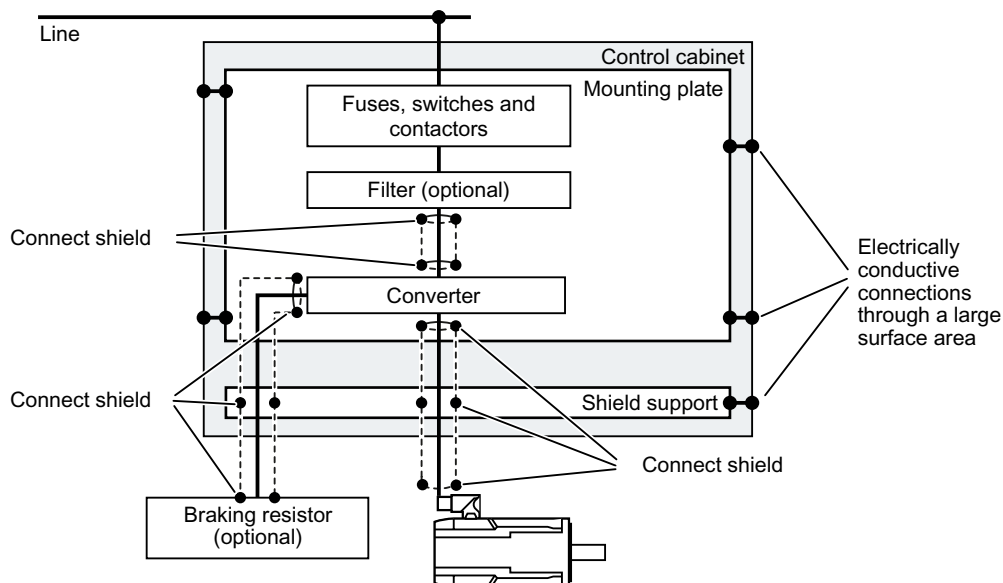

Figure 3-1 Routing converter cables inside and outside a control cabinet

Routing cables outside the control cabinet

- Maintain a minimum clearance of 25 cm between cables with a high level of interference and cables with a low level of interference.
- Use shielded cables for the following connections:
 - Converter motor cable
 - Cable between the converter and braking resistor
 - Signal and data cables

Requirements relating to shielded cables

- Use cables with finely-stranded, braided shields.
- Connect the shield at both ends of the cable.

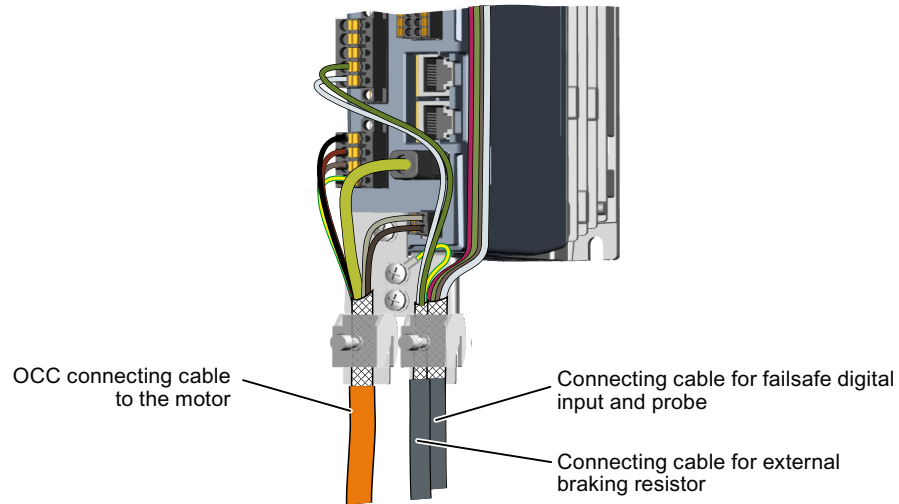

Figure 3-2 Shield support with the shield terminal from the scope of supply of the MOTION-CONNECT OCC cable.

- Connect the shield to the shield support.
- Do not interrupt the shield.

3.1.3 Electromechanical components

Surge voltage protection circuit

- Connect surge voltage protection circuits to the following components:
 - Coils of contactors
 - Relays
 - Solenoid valves
- Connect the surge voltage protection circuit directly at the coil.
- Use RC elements or varistors for AC-operated coils and freewheeling diodes or varistors for DC-operated coils.

3.2 Permissible line supplies and connection options

The converter is designed for the following line supplies according to IEC 60364-1 (2005).

- TN system
- TT system
- IT system

Converter with 1 AC line connection on an IT line system

You must remove the grounding screw when operating the converter on an IT line system. As a consequence, you remove the grounding of the integrated EMC filter.

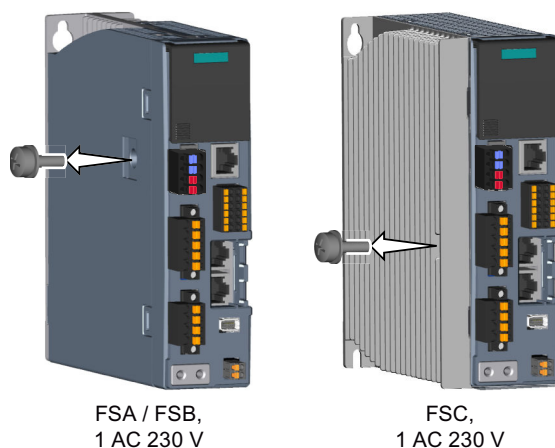

FSA / FSB,
1 AC 230 V

FSC,
1 AC 230 V

Converters with 3 AC line connection

You must observe the following when operating converters with a 3 AC line connection:

- TN and TT line systems with grounded neutral point:
The converter can be directly connected.
- IT line systems as well as TN and TT line systems that are not grounded at the neutral point (for example, with grounded line conductor):
The converter must be connected up via an isolating transformer. The neutral point on the secondary side of the isolating transformer must be grounded.

NOTICE

Destruction of the converter when operated without grounding screw

The converter will be destroyed in operation if the grounding screw is removed for converters with 3 AC line connection.

- Do not remove the grounding screw.

3.2.1 Connecting options for converters with 1 AC line connection

Basic connection options

You have the following options to supply the converter with an input voltage of 230 V.

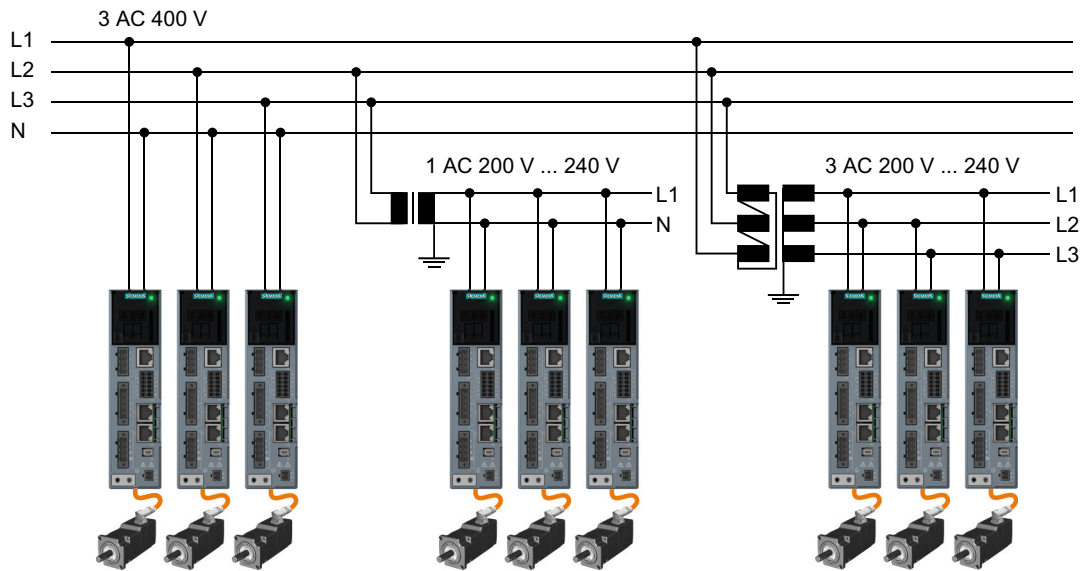

No transformer required. Note the following safety instructions regarding the currents in the neutral conductor.

Transformer required.

Transformer required.

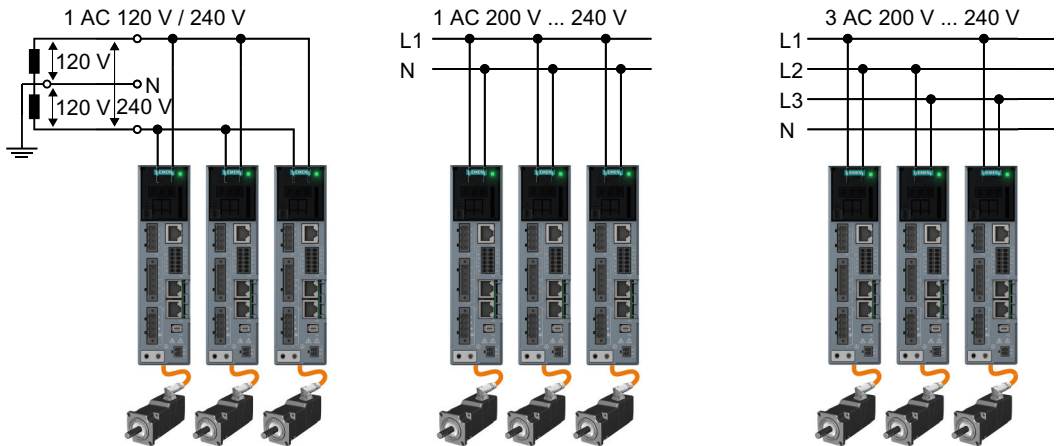

No transformer required.

No transformer required.

No transformer required.

Figure 3-3 Connection options

⚠ WARNING**Neutral conductor fire caused by high currents**

If you connect the converter without an isolation transformer to a supply system with 400 V 3 AC between the N-conductor and a line conductor (L1, L2 or L3), the harmonic currents in the N-conductor can add up to values that are greater than the currents in the line conductors. This heats up the N-conductor and can cause a fire.

- Take the harmonic currents into account when dimensioning the power supply cables.

Connection examples and cable cross-sections

Figure 3-4 Connection example for 230 V 1 AC

• Sum of the input currents of all converters	$\leq 24 \text{ A}$
• Fuses:	3NA3812 or class J 30 A for UL/CSA
• Cables for the line connection up to the terminal box	4 mm ² , dimensioned for $I_{\text{rms}} \geq 32 \text{ A}_{\text{rms}}$ at 50 °C
• Cables for establishing the connection between the terminal box and the converter	2.5 mm ² , dimensioned for $I_{\text{rms}} \geq 18.5 \text{ A}$ at 50 °C

3.2 Permissible line supplies and connection options

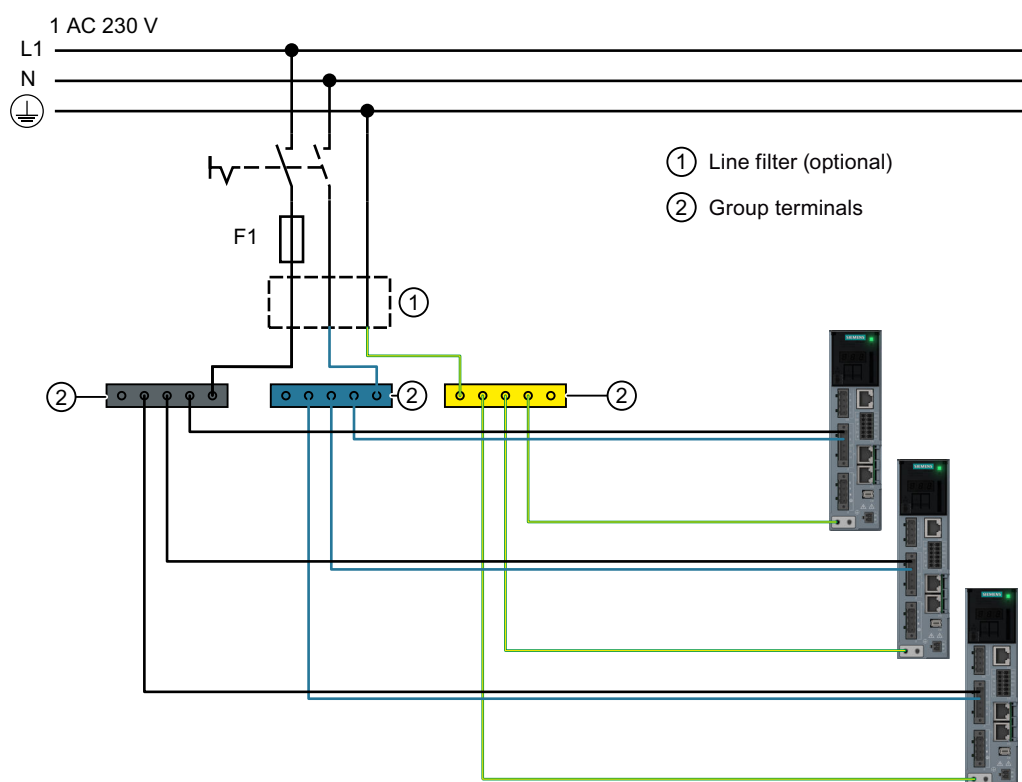
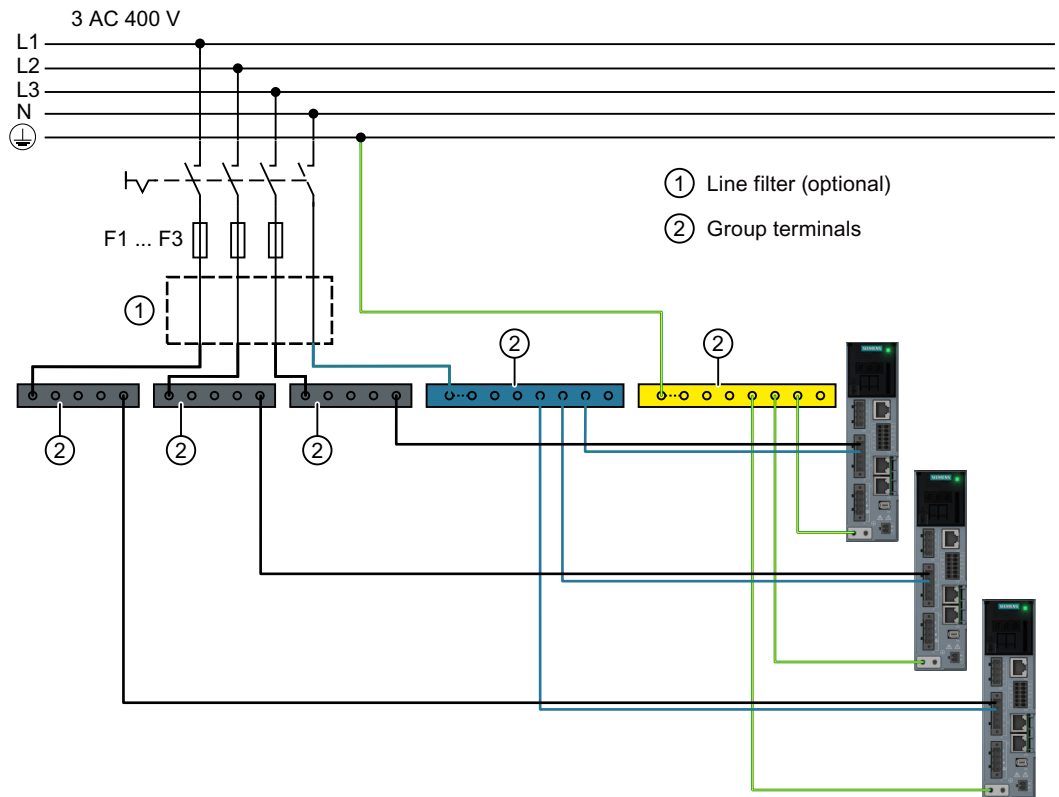

Figure 3-5 Connection example for 400 V 3 AC

<ul style="list-style-type: none"> Sum of the input currents of all converters per phase 	$\leq 24 \text{ A}$
<ul style="list-style-type: none"> Fuses, F1 ... F3 	3NA3812 or class J 30 A for UL/CSA
<ul style="list-style-type: none"> Cables for the line connection up to the terminal box 	4 mm ² , dimensioned for $I_{\text{rms}} \geq 32 \text{ A}_{\text{rms}}$ at 50 °C
<ul style="list-style-type: none"> Cables for establishing the connection between the terminal box and the converter 	2.5 mm ² , dimensioned for $I_{\text{rms}} \geq 18.5 \text{ A}$ at 50 °C

3.2.2 Connecting options for converters with 3 AC line connection

Note

Operating the converter on 3 AC 200 V ... 240 V line supplies

Apply one of the following measures to ensure that the converter is safely and reliably operated:

- Use an external, intrinsically safe braking resistor
- Use a line contactor that shuts down the converter when the "Overtemperature", PROFdrive message class 6 is output (F06 appears on the converter display). It is only permissible that the line contactor is closed after the converter has run up, and therefore the monitoring functions are active.

Connection options

You can connect each converter individually via the standard terminals, or via the optional line cabling.

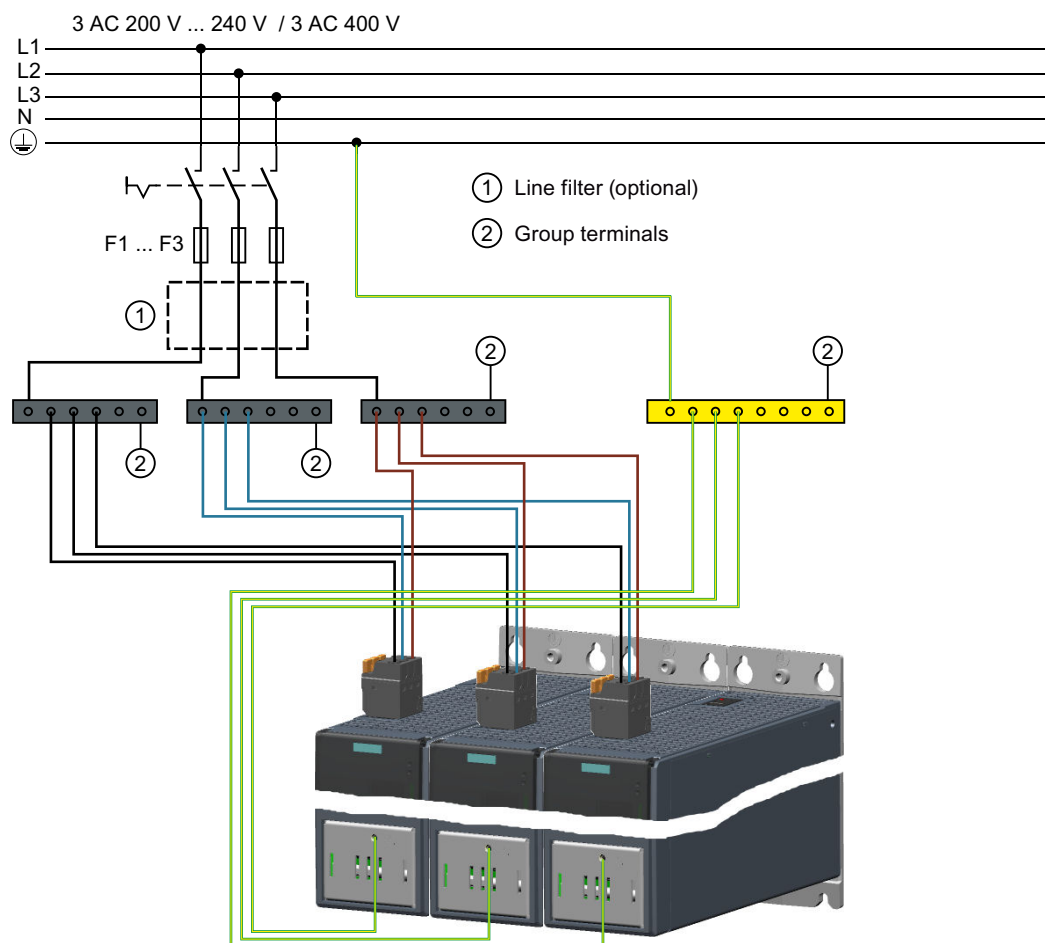

Figure 3-6 Converter with 3 AC line connection without line cabling

3.2 Permissible line supplies and connection options

Sum of the input currents of all converters	80 A
Fuses, F1 ... F3	3NA3 830 (100 A) Class J 100A for UL/CSA, Alternative comparable protective elements with lower rated current
Cables for the line connection up to the terminal box	16 mm ² ... 42 mm ² , depending on the specific installation situation and local regulations
Cables for establishing the connection between the terminal box and the converter	6 mm ²

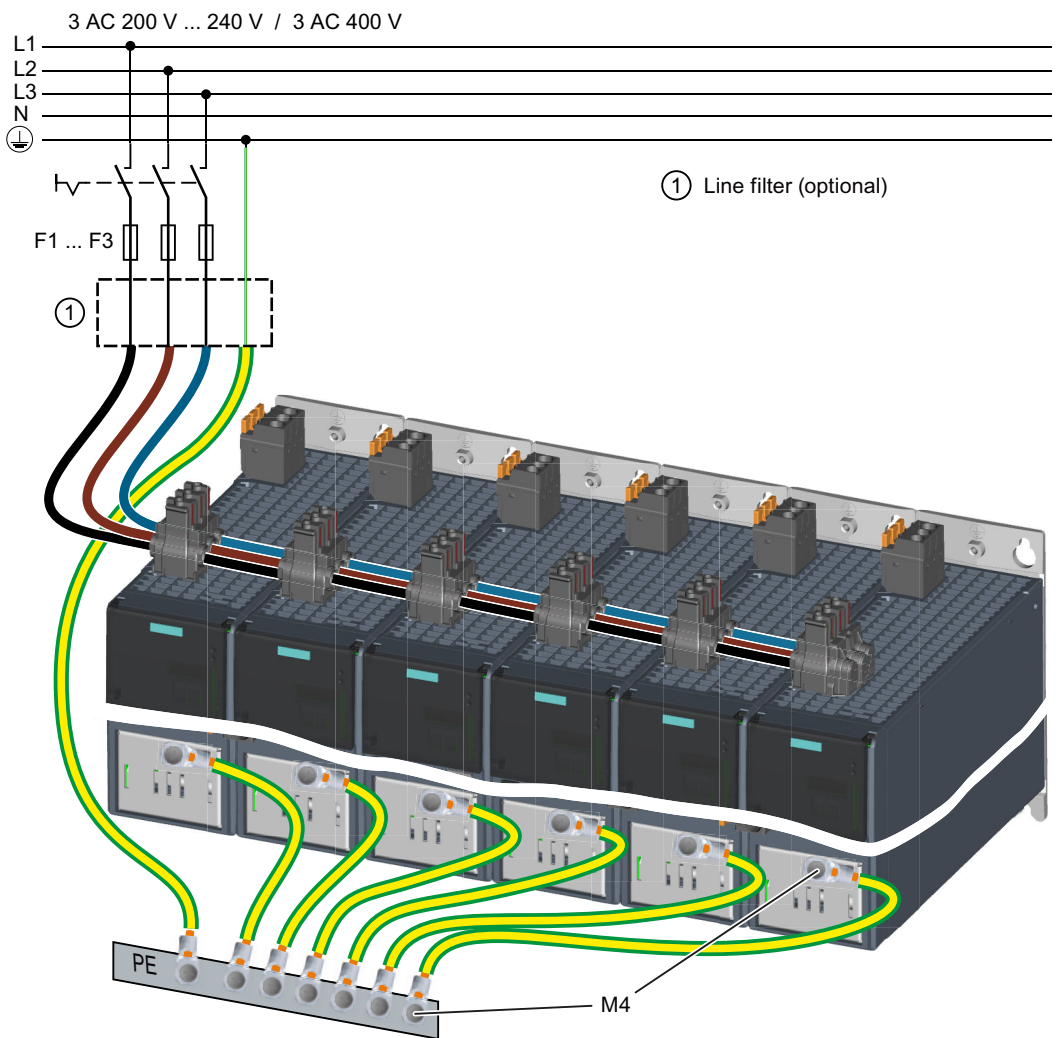



Figure 3-7 Converter with 3 AC line connection with line cabling

Sum of the input currents of all converters	40 A
Fuses, F1 ... F3	3NA3 830 (100 A) Class J 100A for UL/CSA, Alternative comparable protective elements with lower rated current
Cables for the line connection up to the terminal box	16 mm ²
Cables for establishing the connection between the terminal boxes and the converters and for the DC link coupling  Connectors and cables for line and DC link cabling (Page 340)	

3.3 Configuring the motor

3.3.1 Configuration sequence

Motion control

Drives are optimized for motion control applications. They execute linear or rotary movements within a defined movement cycle. All movements should be optimized in terms of time.

As a result, drives must meet the following requirements:

- High dynamic response, i.e. short rise times
- Capable of overload, i.e. a high reserve for accelerating
- Wide control range, i.e. high resolution for precise positioning.

The following table "Configuring procedure" is valid for synchronous and induction motors.

General configuring procedure

The function description of the machine provides the basis for configuration. The components are selected according to physical interdependencies and the selection process is usually carried out in the following sequence of steps:

Table 3-1 Configuring sequence

step	Description of the configuring activity	
1.	Clarify the drive type	Refer to the next chapter
2.	Define the boundary conditions and incorporate them into the automation system	
3.	Define the load case, calculate the maximum load torque and determine the motor	
4.	Define the converter required	Refer to catalog
5.	Repeat steps 3 and 4 for additional axes	
6.	Determine line-side power options (main switch, fuses, line filters, etc.)	
7.	Define other system components (e.g. braking resistors)	
8.	Calculate the current demand of the components for the 24 V DC power supply - and specify the power supplies (SITOP devices, Control Supply Modules)	
9.	Determine the connection system components	
10.	Configure the drive line-up components	
11.	Calculate the required cable cross sections for power supply and motor connections	
12.	Inclusion of mandatory installation clearances	

3.3.1.1 Clarify the drive type

Select the motor on the basis of the required torque (load torque), which is defined by the application, e.g. traveling drives, hoisting drives, test stands, centrifuges, paper and rolling mill drives, feed drives or main spindle drives.

Gearboxes to convert motion or to adapt the motor speed and motor torque to the load conditions must also be taken into account when selecting the motor.

You must know the following mechanical data in order to determine the torque to be supplied by the motor:

- The load torque specified by the application
- Masses to be moved
- Diameter of the drive wheel
- Leadscrew pitch, gear ratios
- Frictional resistance data
- Mechanical efficiency
- Traversing distances
- Maximum velocity
- Maximum acceleration and maximum deceleration
- Cycle time

3.3.1.2 Define the boundary conditions and incorporate them into the automation system

Take the following into account during the configuration:

- The line system configuration when using specific motor types and/or line filters
- Rated values of the motor
- The ambient temperatures and the installation altitude of the motors and drive components
- Heat dissipation from the motors

Other conditions apply when integrating the drives into an automation environment such as SIMATIC or SIMOTION.

For motion control and technology functions (e.g. positioning), as well as for synchronous operation functions, the corresponding automation system, e.g. SIMATIC S7-1500 or SIMOTION D is used.

3.3.1.3 Define the load case, calculate the maximum load torque and determine the motor

The motors are defined bases on the motor type-specific limiting characteristic curves.

The limiting characteristic curves describe the torque or power curve over the speed.

The limiting characteristic curves take the limits of the motor into account on the basis of the DC-link voltage. The DC-link voltage is dependent on the line voltage.

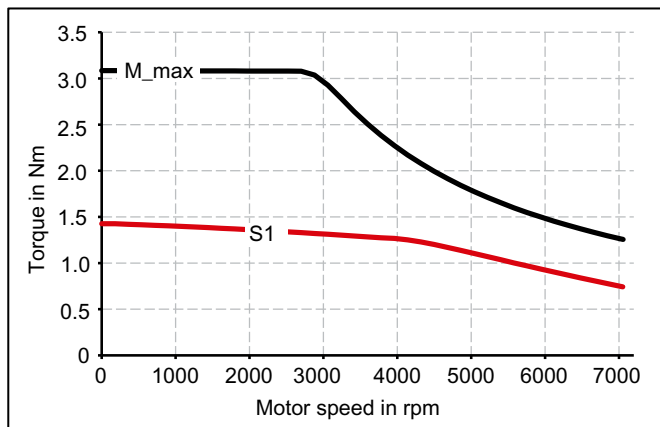

M_max Curve of the maximum torque
 S1 S1 characteristic

Figure 3-8 Limit characteristics for synchronous motors

Procedure

1. Determine the load which is specified by the application. Use different characteristics for the different loads. The following operating scenarios have been defined:
 - Duty cycle with constant ON duration
 - Free duty cycle
2. Determine the characteristic torque and speed operating points of the motor for the defined load.
3. Calculate the acceleration torque of the motor. Add the load torque and the acceleration torque to obtain the maximum required torque.
4. Verify the maximum motor torque with the limiting characteristic curves of the motors. The following criteria must be taken into account when selecting the motor:
 - Adherence to the dynamic limits
All speed-torque points of the load event must lie below the relevant limiting characteristic curve.
 - Adherence to the thermal limits
At average motor speed, the effective motor torque must be below the S1 characteristic (continuous operation) during the load.

You have specified a motor.

Duty cycles with constant ON duration

For duty cycles with constant ON duration, there are specific requirements for the torque characteristic curve as a function of the speed, for example:

$M = \text{constant}$, $M \sim n^2$, $M \sim n$ or $P = \text{constant}$.

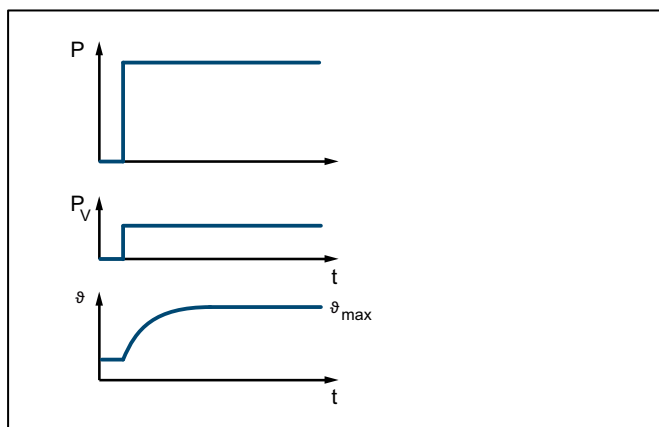
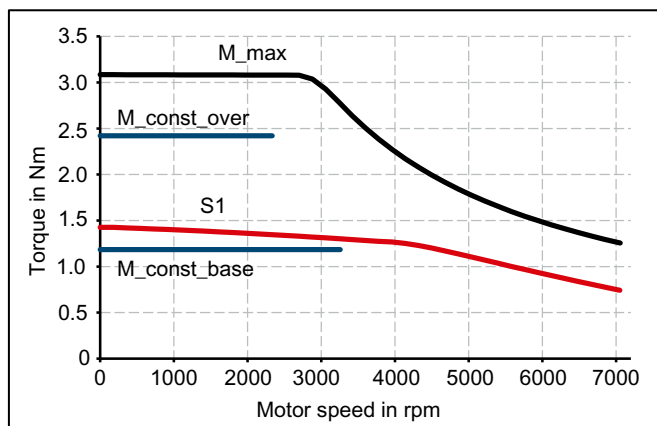

Figure 3-9 S1 duty (continuous operation)

The drives with this load cycle typically operate at a stationary operating point.

Procedure

1. Configure a base load for the stationary operating point. The base load torque must lie below the S1 characteristic.
2. In the event of transient overloads (e.g. during acceleration), configure an overload. Calculate the overload current in relation to the required overload torque. The overload torque must lie below the M_max characteristic.
In summary, the motor is configured as follows:



M_max	Curve of the maximum torque	M_const_ov	Curve of the overload torque
		er	
S1	S1 characteristic	M_const_b	Curve of the base load torque
		ase	

Figure 3-10 Motor selection for a duty cycle with constant switch-on duration

3. Select a motor that satisfies the requirements of S1 duty.



Free duty cycle

A free duty cycle defines the curve of the motor speed and the torque over time.

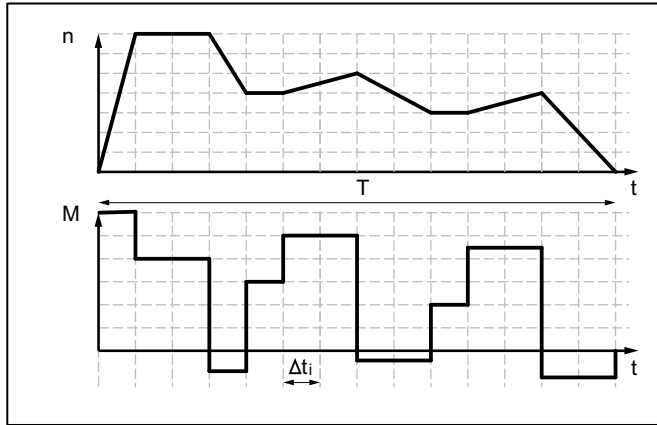

n Speed T Cycle time
 M Torque Δti Time interval
 t Time

Figure 3-11 Example of free duty cycle

Procedure

Determine the required motor torque as follows:

- Define a load torque for each time slice. Also take the average load moment of inertia and motor moment of inertia into account for acceleration operations. If required, take a frictional torque into account that opposes the direction of motion.
- With mounted gearbox:
 Determine the load torque and the acceleration torque that must be supplied by the motor. Take the gear ratio and gear efficiency into account.

Note

A higher gear ratio increases positioning accuracy in terms of encoder resolution. For any given encoder resolution, as the gear ratio increases, so does the resolution of the machine position to be detected.

The following formulas can be used for duty cycles outside the field weakening range.

For the motor torque in a time slice Δt_i , the following applies:

$$M_{Mot, i} = (J_M + J_G) \cdot \frac{2\pi}{60} \cdot \frac{\Delta n_{Last, i}}{\Delta t_i} \cdot i + \left(J_{Last} \cdot \frac{2\pi}{60} \cdot \frac{\Delta n_{Last, i}}{\Delta t_i} + M_{Last, i} + M_R \right) \cdot \frac{1}{i \cdot \eta_G}$$

The motor speed is:

$$n_{Mot, i} = n_{Last, i} \cdot i$$

The effective torque is obtained as follows:

$$M_{Mot, eff} = \sqrt{\frac{\sum M_{Mot, i}^2 \cdot \Delta t_i}{T}}$$

The average motor speed is calculated as follows:

$$n_{Mot, mittel} = \frac{\sum n_{Mot, i, A} + n_{Mot, i, E} \cdot \Delta t_i}{T}$$

J_M	Motor moment of inertia
J_G	Gearbox moment of inertia
J_{load}	Load moment of inertia
n_{load}	Load speed
i	Gear ratio
η_G	Gearbox efficiency
M_{load}	Load torque
M_R	Frictional torque
T	Cycle time
A; E	Initial value, final value in time slice Δt_i
t_e	ON duration
Δt_i	Time interval

The effective torque M_{eff} must lie below the S1 characteristic.

The maximum torque M_{max} is produced during the acceleration operation. M_{max} must lie below the voltage limiting characteristic curve. In summary, the motor is configured as follows:

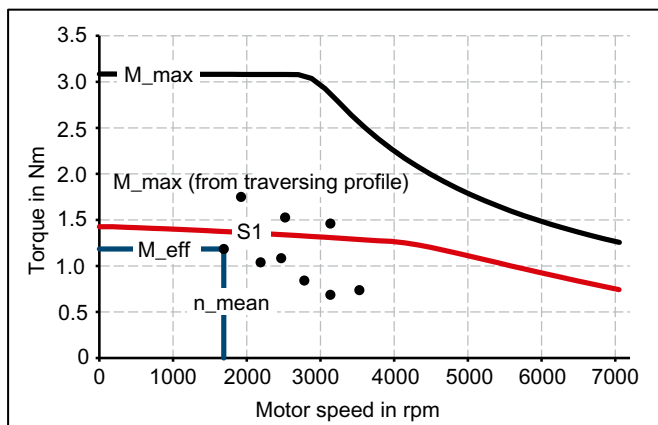

M_{max}	Curve of the maximum torque	S1	S1 characteristic = M_0
M_{eff}	Effective torque	•	Points from the traversing profile
n_{mean}	Mean speed		

Figure 3-12 Motor selection for duty cycle

You have defined the characteristic motor values corresponding to the duty cycle.



Defining the motor

By varying, you can find the motor that satisfies the conditions of the operating mode (duty cycle).

- Determine the motor current at base load. The calculation depends on the type of motor (synchronous motor or induction motor) and the operating mode (duty cycle) used.

Note

When configuring according to duty cycle with constant ON duration with overload, the overload current is calculated in relation to the required overload torque.

- Comply with the thermal limits of the motor.
- Configure the other properties of the motor through the available motor options.

3.4 Configuring the braking resistor

The converter has a Braking Module that converts regenerative energy of the servomotor into heat via an integrated braking resistor. Regenerative energy is produced, for example, when braking the connected mechanical system.

If the motor feeds back more energy than can be dissipated by the braking resistor, then the converter shuts down with fault F30002 (DC link overvoltage). In this case, you will require an external braking resistor.

If you are familiar with your system's moments of inertia in relation to the motor shaft, it is possible for you to calculate the generated braking energy using the formula in the following section.

The values for the integrated braking resistor can be obtained in the following table.



Table 3-2 Values of the integrated braking resistor in relation to the shaft of the servomotor

Converter article number (power)	Continuous braking power in W	Peak power in kW	Braking energy in J
Converter with 1 AC line connection			
6SL3210-5HB10-1UF0 (0.1 kW)	5	---	20
6SL3210-5HB10-2UF0 (0.2 kW)	10	1.1	570
6SL3210-5HB10-4UF0 (0.4 kW)	20	1.7	840
6SL3210-5HB10-8UF0 (0.75 kW)	40	3.3	1680
Converter with 3 AC line connection			
6SL3210-5HE10-4UF0 (0.4 kW)	50	3	300
6SL3210-5HE10-8UF0 (0.75 kW)	50	3	300
6SL3210-5HE11-0UF0 (1 kW)	50	3	300
6SL3210-5HE11-5UF0 (1.75 kW)	100	6.0	600
6SL3210-5HE12-0UF0 (2 kW)	100	6.0	600
6SL3210-5HE13-5UF0 (3.5 kW)			
6SL3210-5HE15-0UF0 (5 kW)			
6SL3210-5HE17-0UF0 (7 kW)			

3.4.1 Calculating the braking energy

To find out whether you require an external braking resistor, calculate the braking energy according to the following formula:

$$W = \frac{1}{2} (J_{mot} + J) \frac{4\pi^2}{3600} (n_1^2 - n_2^2)$$

W / J	Braking energy
J_{mot} / kgm^2	Moment of inertia of the servomotor
	 High Dynamic (Page 296)
	 Compact (Page 303)
J / kgm^2	Moment of inertia of the driven mechanical system in relation to the shaft of the servomotor
n_1 / rpm	Initial speed
n_2 / rpm	Speed after braking

Note

As the friction is not taken into account in the above formula, less energy is fed back to the servo drive system in practice than that calculated in the formula.

Example

Servomotor with low moment of inertia, power 0.75 kW

Moment of inertia of the servomotor 1FK2104-5AK1... $J_{mot} = 0.65 \times 10^{-4} \text{ kgm}^2$

Moment of inertia of the driven mechanical system $J = 4 \times 10^{-4} \text{ kgm}^2$

$n_1 = 3000 \text{ rpm}$ $n_2 = 600 \text{ rpm}$

$\Rightarrow W = 22.03 \text{ J}$ (1 J = 1 Ws)

The braking energy that can be absorbed by the integrated braking resistor (1680 J) is higher than the actual braking energy (22.03 J). In this case, therefore, no external braking resistor is required.

3.4.2 Requirements placed on the external braking resistor

 WARNING
Risk of fire caused by continuous overload
If the external braking resistor is continuously overloaded, for example as the result of a defective braking chopper, this can cause an explosion or fire - resulting in death or severe injury and/or could cause the housing to melt.
<ul style="list-style-type: none"> • Use only braking resistors that are intrinsically safe.

Table 3-3 Resistance data for an external braking resistor

Converter article number (power)	Braking resistor		Peak braking power in kW
	Resistance in Ω	Continuous power in W	
Converter with 1 AC line connection			
6SL3210-5HB10-1UF0 (0.1 kW)	150	50	1.09
6SL3210-5HB10-2UF0 (0.2 kW)	150	100	1.09
6SL3210-5HB10-4UF0 (0.4 kW)	100	200	1.64
6SL3210-5HB10-8UF0 (0.75 kW)	50	380	3.28
Converter with 3 AC line connection			
6SL3210-5HE10-4UF0 (0.4 kW)	200	200	3
6SL3210-5HE10-8UF0 (0.75 kW)	200	380	3
6SL3210-5HE11-0UF0 (1 kW)	200	500	3
6SL3210-5HE11-5UF0 (1.75 kW)	100	880	6
6SL3210-5HE12-0UF0 (2 kW)	100	1000	6
6SL3210-5HE13-5UF0 (3.5 kW)	30	1750	20
6SL3210-5HE15-0UF0 (5 kW)	30	2500	20
6SL3210-5HE17-0UF0 (7 kW)	30	3250	20

Table 3-4 Examples of suitable braking resistors from a third-party supplier

Converter article number (power)	Braking resistor, Michael Koch GmbH or equivalent			
	Order number	Resistance in Ω	Continuous braking power in W	Peak braking power in kW
Converter with 1 AC 230 V				
6SL3210-5HB10-1UF0 (0.1 kW)	BWG250150	150	50	1.1
6SL3210-5HB10-2UF0 (0.2 kW)	BWG250150	150	100	1.1
6SL3210-5HB10-4UF0 (0.4 kW)	BWG500100	100	200	1.7
6SL3210-5HB10-8UF0 (0.75 kW)	BWG600047 ¹⁾	47	240	3.6
Converter with 3 AC 400 V				
6SL3210-5HE10-4UF0 (0.4 kW)	BWG500430	430	200	1.5
6SL3210-5HE10-8UF0 (0.75 kW)	BWG1000200	200	400	3
6SL3210-5HE11-0UF0 (1 kW)	BWG1000200 ²⁾	200	400	3
6SL3210-5HE11-5UF0 (1.75 kW)	BWG1000100 ²⁾	100	400	6
6SL3210-5HE12-0UF0 (2 kW)	BWG1000100 ²⁾	100	400	6
6SL3210-5HE13-5UF0 (3.5 kW)				
6SL3210-5HE15-0UF0 (5 kW)				
6SL3210-5HE17-0UF0 (7 kW)				

1) For thermal reasons, it is not permissible that the continuous braking power of 240 W is exceeded.

2) For thermal reasons, it is not permissible that the continuous braking power of 400 W is exceeded.

Note

Braking resistor with temperature monitoring

Use only a braking resistor with temperature monitoring.

3.4.3 Connecting an external braking resistor

Connecting an external braking resistor

Use shielded cables to connect power to the external braking resistor.

How to connect the external braking resistor and the temperature monitoring is described in the following Sections:

for converters with 3 AC line connection:  (Page 170)

for converters with 1 AC line connection:  (Page 162)

Setting the temperature monitoring of the external braking resistor

If you have connected the external braking resistor with motor temperature monitoring, you must activate the temperature monitoring via the web server of the converter.

 Connecting a digital input (Page 171)

 Configuring digital inputs (Page 204).

Activate the digital input DI 4 "Temperature monitoring of the external braking resistor".

The converter switches the motor off as soon as the external braking resistor is too hot or when no external braking resistor is connected (wire break).

3.5 DC link coupling

DC link coupling for converters with 3 AC 400 V line connection

Using connector X3 you can connect the DC links of up to six converters with one another.

This means that the DC links of the individual converters are essentially combined to create a large common DC link. As a consequence, motors operating in the same DC link group can balance the power flow between generating and motoring operation.

As a consequence, energy recovered by drives operating in the generating mode does not have to be converted into heat in the braking resistor, but instead, can be used by drives operating in the motoring mode.

Prerequisites and conditions for the DC link coupling:

- It is permissible to couple the DC links of converters with different power ratings.
- The converters must be mounted with decreasing power ratings starting from the line supply infeed.

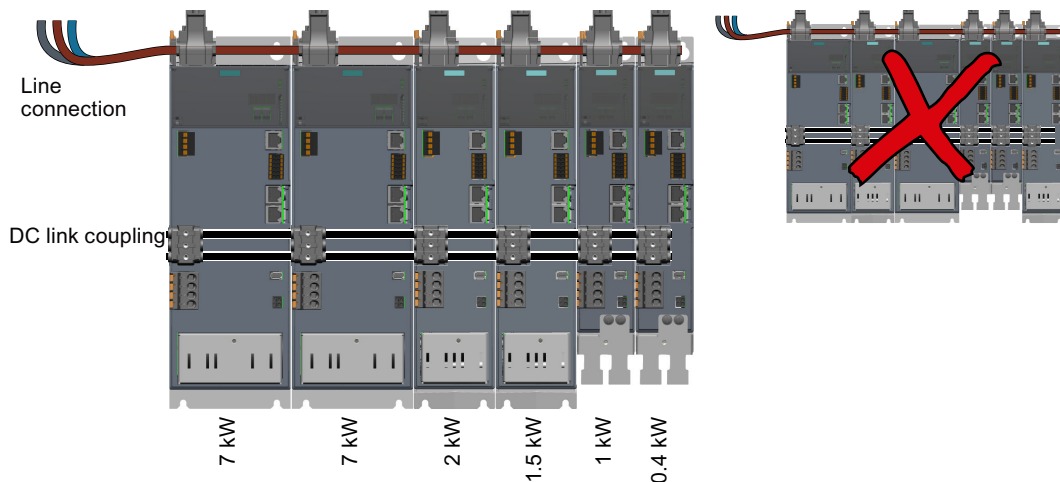

- Line cabling for up to six converters are also permissible, even if they are not operated in a common DC link group.

Note

- For a DC link coupling, line connection via the standard connector is not permissible.
- Feeding in DC power directly at the DC link is not permissible!

Procedure to establish the DC link coupling

1. Mount the converters, without any intermediate spaces, with decreasing power ratings starting from the line supply infeed.
2. Establishing the line supply and DC link cabling:
Use the connectors and cables that are described in the following section:

 Connectors and cables for line and DC link cabling (Page 340)

Note

Converters, frame size FSC

At the time the manual was being created, it was not clear as to whether converters with frame size FSC can be connected with other frame sizes.

As a consequence, when converters with frame size FSC become available, carefully observe the product information or manuals on the S210 in the Internet.

 Product information for S210, V5.2 (<https://support.industry.siemens.com/cs/ww/en/ps/24672/man>)

Additional external braking resistors for the DC link coupling

The entire braking power of all converters coupled in a group is always available for braking.

If you require an external braking resistor for your system in spite of a DC link coupling, then you must connect this to the converter with the highest power rating. If an additional external braking resistor is required, then this must be connected to the converter with the second highest power rating – and so on.

Additional information

 Configuring the braking resistor (Page 65)

Special features for converters with a 3 AC 200 V ... 240 V line connection

When this manual was prepared, the DC link coupling was only permissible for converters within the same frame size. Otherwise, the above mentioned points apply.

When connected to 3 AC 200 V ... 240 V line supplies, also refer to the following Section:

 Connecting options for converters with 3 AC line connection (Page 55)

3.6 Application examples

You can find SINAMICS application examples on the Internet page "SINAMICS application examples".

1. Call the following site in your Internet browser:
SINAMICS application examples (<https://www.automation.siemens.com/mc-app/sinamics-application-examples/Home/Index?language=en>)

2. Select the required filter in the search mask.
Example:

The screenshot shows a search filter interface with the following elements:

- DriveType:** S120 [3] (dropdown menu with a close 'X' button)
- DriveFunction:** Safety-control [3] (dropdown menu with a close 'X' button)
- Control:** (empty dropdown menu)
- EngineeringEnvironment:** (empty dropdown menu)
- Communication:** PROFIBUS [3] (dropdown menu with a close 'X' button)
- Speciality:** (empty dropdown menu)
- Reset Filter:** (button)

The result list is updated every time a filter setting is specified.

Application	DriveType	DriveFunction	Control	EngineeringEnvironment	Communication	Speciality
> SINAMICS S: Safety-control of a S120 using S7-300/400 (STEP 7 V5) with PROFIBUS and Safety Integrated (via PROFIsafe)	S120	Safety-control	S7-300/400	STEP 7 V5	PROFIBUS	Safety Integrated
> SINAMICS S: Safety-control of a S120 using S7-300/400 (STEP 7 V5) with PROFIBUS and Safety Integrated (via TM54F)	S120	Safety-control	S7-300/400	STEP 7 V5	PROFIBUS	Safety Integrated
> SINAMICS S: Safety-control of a S120 using S7-300/400 (STEP 7 V5) with PROFINET (Shared Device) and Safety Integrated (via PROFIsafe)	S120	Safety-control	S7-300/400	STEP 7 V5	PROFIBUS PROFINET	Safety Integrated

You reset individual filters by clicking the X to the right of the filter. You reset all filters simultaneously by clicking the "Reset filters" button.

3.7 Establishing communication of the converter with the controller

In order that communication between the PLC and converter is possible, configure the converter or converters in the PLC, and activate the topology-based initialization. When powering up, the converter takes the PROFINET device name as well as the IP address from the PLC.

The converter also imports the telegram settings from the PLC.

The converter supports a standard telegram with 2 supplementary telegrams and a PROFIsafe telegram.

The following telegrams are possible:

Standard telegrams:

- Telegram 3
- Telegram 5
- Telegram 102
- Telegram 105

The telegrams are suitable for IRT communication.

Telegrams 3 and 102 are also suitable for RT communication.

IRT communication is mandatory for telegrams 5 and 105.

Supplementary telegrams

- Telegram 700
- Telegram 701
- Telegram 750

PROFIsafe telegrams

- Telegram 30 (recommended for Safety Integrated Basic Functions)
- Telegram 901 (recommended for Safety Integrated Extended Functions)

For further information about telegrams

 Communication telegrams (Page 539)

3.8 Functions that require a license

You require a memory card with a license key for function packages that require a license.

The function packages requiring a license are released by inserting the memory card with the license key into a converter. The function packages are no longer released if the card is removed from the converter.

A "Certificate of License" (abbreviated, CoL) belongs to each license key as proof that you own the license.

Properties of the license key

- The license key is permanently assigned to a memory card.
- A license key cannot be transferred

Assigning a license key to a memory card

A license key can only be assigned to a SINAMICS memory card.

 Memory cards (Page 339)

You have the following options of assigning a license key to a memory card:

- You order a license together with a memory card.
You receive a memory card with the license key and a Certificate of License.
- Proceed as follows if your converter works with a memory card that you wish to assign a license to:
 - You purchase a Certificate of License.
 - With the Certificate of License, using the "WEB License Manager" you generate a license key.
WEB License Manager (<http://www.siemens.com/automation/license>)
 - Assign the license key to the memory card.
 Using functions that require a license (Page 248)

Note

Refer to your ordering documentation (e.g. catalogs) for information on basic functions and functions subject to license.

The licenses are saved to folder "KEYS" on the memory card.



Safety functions integrated in the drive

In comparison to standard drive functions, safety functions (Safety Integrated Functions) have an especially low error rate. Performance Level (PL) and Safety Integrity Level (SIL) of the corresponding standards are a measure of the error rate.

As a consequence, the safety functions are suitable for use in safety-related applications to minimize risk. An application is safety-related if the risk analysis of the machine or the system indicates a special hazard potential in the application.

Safety Integrated ("drive-integrated") means that the safety functions are integrated in the drive and can be executed without requiring additional external components.

Conformity

The Safety Integrated Functions comply with:

- Safety Integrity Level (SIL) 2 according to DIN EN 61508
- Category 3 according to DIN EN ISO 13849-1
- Performance level (PL) d according to DIN EN ISO 13849-1

The Safety Integrated Functions correspond to functions according to EN 61800-5-2.

PFH values

The probability of failure of safety functions must be specified in the form of a PFH value (Probability of Failure per Hour) according to IEC 61508, IEC 62061 and DIN EN ISO 13849-1. The PFH value of a safety function depends on the safety concept of the drive unit and its hardware configuration, as well as on the PFH values of other components used for this safety function.



- The PFH values of the SINAMICS S210 can be found at:
PFH values (<https://support.industry.siemens.com/cs/ww/en/view/76254308>)
- The PFH values of all Safety components from Siemens are available in the "Safety Evaluation Tool"; see:
Safety Evaluation Tool (<http://www.industry.siemens.com/topics/global/en/safety-integrated/machine-safety/safety-evaluation-tool/Pages/default.aspx>)

4.1 Basic Functions

These functions are part of the standard scope of the drive and can be used without requiring an additional license. The Basic Functions comprise the following functions:

- Safe Torque Off (STO)
- Safe Brake Control (SBC)
- Safe Stop 1 time-controlled (SS1-t)

Functions STO and SS1-t are selected via the F-PLC and/or via the failsafe digital input.

 Safety settings in the web server (Page 211)

In order to select the functions via the F-PLC, the communication must be configured in the F-PLC via PROFIsafe.

Details regarding the settings can be obtained in the following sections:

 Configuring safety functions (Page 118)

 Establishing communication of the converter with the controller (Page 73)

The Safety Integrated Functions are executed with a safety monitoring cycle of 4 ms.

4.1.1 Safe Torque Off (STO)

Overview

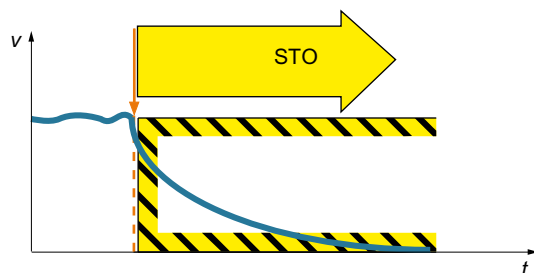

Safe Torque Off (STO) is a safety function that immediately ensures that torque or force-generating energy is not fed to the motor. This function corresponds to stop category 0 to EN 60204-1.

If the motor is still rotating when STO is selected, then it coasts down to standstill.

Functional features

The switching on inhibited prevents an automatic restart after deselection of STO and therefore satisfies the requirements of EN 60204-1. Consequently, the STO function prevents an electrically-driven machine component from restarting.

Note

There is no galvanic isolation between motor and drive.

You can select the STO function via PROFIsafe and/or the Failsafe Digital Input (F-DI).

Applications

Applications include all machines and systems with moving axes (e.g. conveyor technology, handling).

STO is suitable for applications where the motor is already at a standstill or will come to a standstill in a short, safe period of time as a result of friction.

STO allows you to work safely on the machine with the protective door open. A classic Emergency Stop with electromechanical isolation is not required. The drive remains connected to the line and can be fully diagnosed.

Note

The distinction between Emergency Off and Emergency Stop

"Emergency Off" and "Emergency Stop" are commands that minimize different risks in the machine or plant.

The STO function is suitable for implementing an Emergency Stop - but not an Emergency Off.

Details regarding the distinction between Emergency Off and Emergency Stop are provided in the following section:

 What is the difference between the Emergency Off and Emergency Stop functions? (Page 548)

Flow diagram

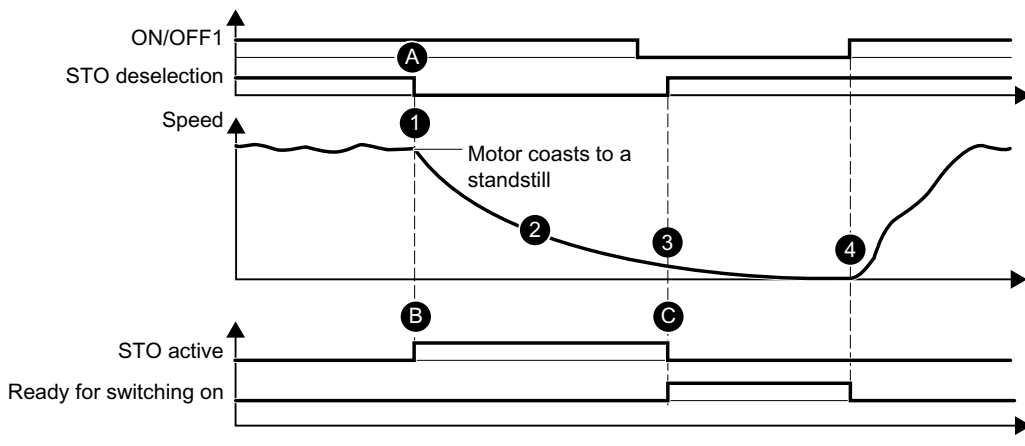

Behavior	
1	<ul style="list-style-type: none"> During operation, STO is selected via PROFIsafe and/or F-DI.
2	<ul style="list-style-type: none"> After the response time, the drive immediately initiates safe pulse suppression. This safely interrupts the torque-generating energy fed to the motor. The motor coasts down to a standstill. STO safely prevents the motor restarting.
3	<ul style="list-style-type: none"> STO is deactivated by the drive with (manual or automatic program-controlled) deselection. The drive is again "ready for switching on".
4	<ul style="list-style-type: none"> You restart the drive with a positive signal edge at ON/OFF1.

Settings	
A	<ul style="list-style-type: none"> STO is selected via the control bit of the selected PROFIsafe telegram or via the F-DI.
B	<ul style="list-style-type: none"> The "STO_active" status is signaled in the status bit of the PROFIsafe telegram. This value can be applied in the higher-level controller.
C	<ul style="list-style-type: none"> The Safety error is acknowledged with selection/deselection of the STO function. Additional information is provided in Chapter "Faults (Page 262)".

Selecting/deselecting "Safe Torque Off"

If "Safe Torque Off" is selected, the motor holding brake is closed (if connected and configured).

Deselecting "Safe Torque Off" represents an internal safety acknowledgment. The following happens once the cause of the fault has been eliminated:

1. The Safety requirement "Close motor holding brake" is canceled.
2. The possibly active F01611 fault or STO is withdrawn.
3. In addition, reset the messages in the fault buffer using the general acknowledgment mechanism.

4.1.2 Safe Stop 1 (SS1, time-controlled)

Overview

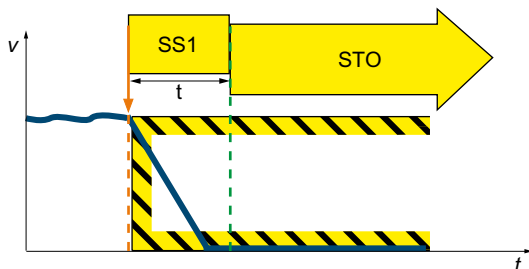

The "Safe Stop 1" function (SS1, time-controlled) causes a drive-autonomous deceleration of the motor and initiates the "Safe Torque Off" (STO) function after a predefined time interval has elapsed. This function corresponds to stop category 1 to EN 60204-1.

Functional features

The Safety Integrated Basic Function "Safe Stop 1" is available in the following versions:

- SS1 with OFF3 (SS1-t according to IEC 61800-5-2)
- SS1 with external stop (SS1E-t)

Set the SS1 response for Safety commissioning in the "Parameterization" step.

Applications

SS1 can be applied in the following cases:

- The load torque cannot reduce the motor to a standstill through friction within a sufficiently short time.
- Coasting down of the drive (STO) will pose risks to safety.

SS1 with OFF3 (SS1-t)

When SS1-t is selected, the motor speed is reduced along the OFF3 ramp for the duration of the selected delay time. After the delay time expires, the drive activates the STO function (independent of the actual speed).

Note

Braking at the OFF3 ramp is not monitored!

Flow diagram SS1 with OFF3 (SS1-t)

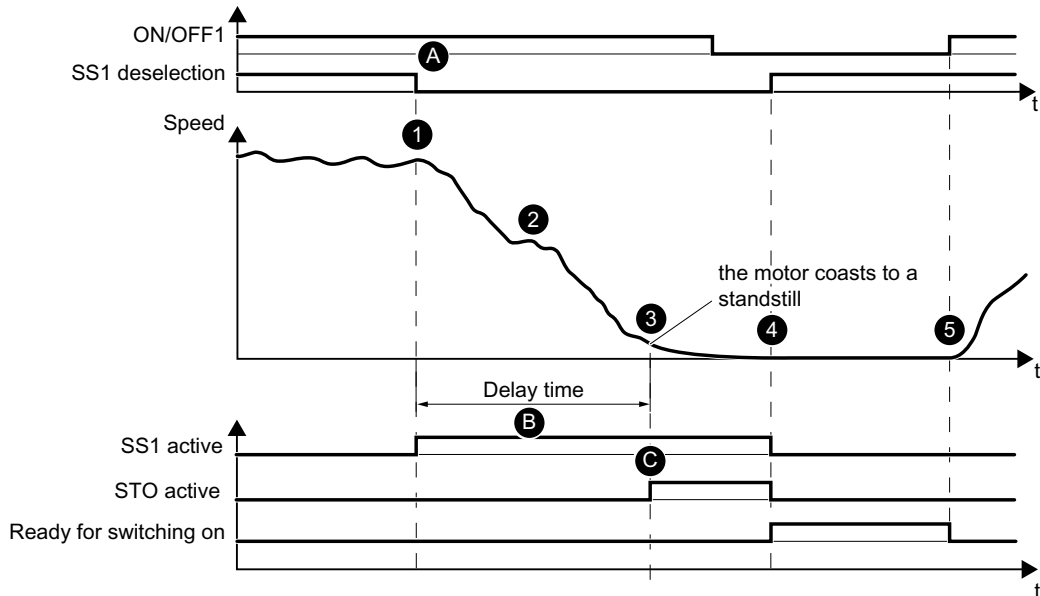

Behavior	
1	<ul style="list-style-type: none"> SS1 is selected in operation.
2	<ul style="list-style-type: none"> The drive immediately initiates braking following the response time via the OFF3 ramp. At the same time, the drive initiates the SS1 delay time.
3	<ul style="list-style-type: none"> The drive triggers STO once the SS1 delay time has elapsed. The motor coasts down to a standstill. STO safely prevents the motor restarting.
4	<ul style="list-style-type: none"> SS1 and STO are deactivated by the drive with (manual or automatic program-controlled) deselection. The drive is again "ready for switching on".
5	<ul style="list-style-type: none"> You restart the drive with a positive signal edge at ON/OFF1.

Settings	
A	<ul style="list-style-type: none"> SS1 is selected via the control bit of the selected PROFIsafe telegram or via the F-DI.
B	<ul style="list-style-type: none"> The drive brakes the motor along the OFF3 ramp. Once the SS1 delay time (p9652) has expired, the drive automatically triggers STO independently of the current speed.
C	<ul style="list-style-type: none"> The "SS1_active" status is signaled in the status bit of the PROFIsafe telegram. This value can be applied in the higher-level controller. When STO becomes active, the "SS1_active" status is also signaled in the status bit of the PROFIsafe telegram.

SS1 with external stop (SS1E-t)

If several drives are connected with one another through a material web, then braking initiated by a single drive at the related OFF3 ramp can damage the machine or system.

When the safety function SS1E-t is used, the drive is shut down using the user program of a higher-level control system. Although the safe delay time is activated when SS1E-t is selected, OFF3 is not activated. Using an appropriate program, the control must then ramp down the drives involved within the delay time to the safe state. After the delay time has elapsed, the drive activates the STO function and safely interrupts the energy feed to the motor (independent of the actual speed).

In Startdrive, select this function from the drop-down list "SI SS1 drive based braking response".

Sequence diagram, SS1 with external stop (SS1E-t)

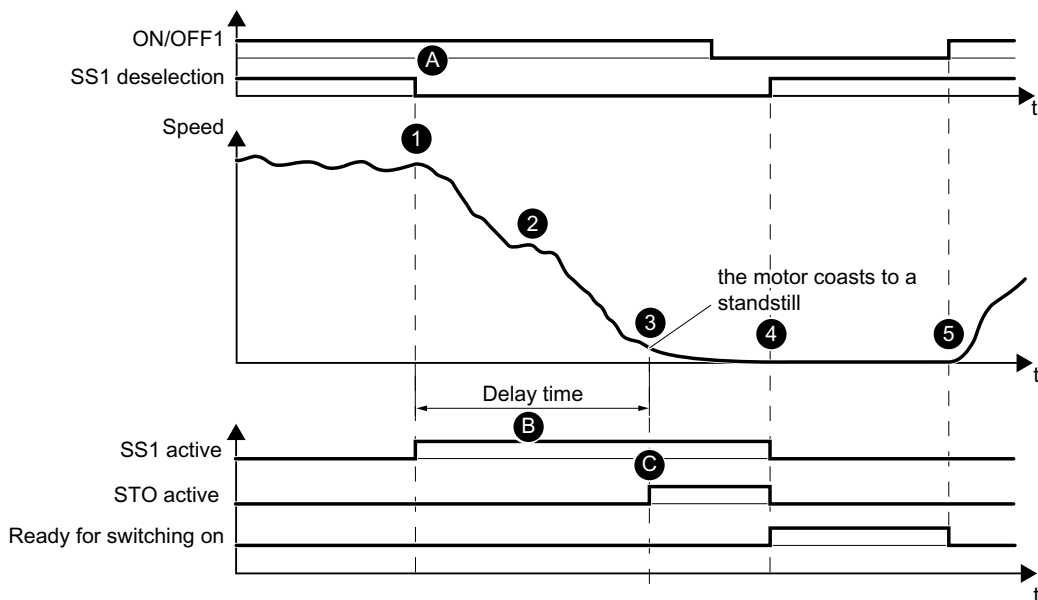

Behavior	
1	<ul style="list-style-type: none"> SS1 is selected in operation.
2	<ul style="list-style-type: none"> The control system initiates stopping using the setpoint that is entered. At the same time, the drive initiates the SS1 delay time.
3	<ul style="list-style-type: none"> The drive triggers STO once the SS1 delay time has elapsed. The motor coasts down to a standstill. The pulse inhibit safely prevents the motor restarting.
4	<ul style="list-style-type: none"> SS1 and STO are deactivated by the drive with (manual or automatic program-controlled) deselection. The drive is again "ready for switching on".
5	<ul style="list-style-type: none"> You restart the drive with the ON/OFF1 signal.

Settings	
A	<ul style="list-style-type: none"> To use SS1E, set the braking response (p9507.3 = 1) to "SS1E external stop". SS1 is selected via the control bit of the selected PROFIsafe telegram or via the F-DI.
B	<ul style="list-style-type: none"> The motor is braked by the external setpoint that is entered. Once the SS1 delay time (p9652) has expired, the drive automatically triggers STO independent of the actual speed.
C	<ul style="list-style-type: none"> The "SS1_active" status is signaled in the status bit of the PROFIsafe telegram. This value can be applied in the higher-level controller. When STO becomes active, the "SS1_active" status is also signaled in the status bit of the PROFIsafe telegram.

Note

SS1 cannot be interrupted

- If SS1 is deselected again during this time, the STO function is selected and deselected again by the drive immediately after the delay time has elapsed or the speed has dropped below the shutdown speed. This terminates the SS1 function normally. It cannot be interrupted.
- During the delay time, SS1 cannot be deselected by withdrawing the control command, therefore fulfilling the requirements of EN 60204-1 relating to an Emergency Stop function.

Setting the delay time for SS1

Select the SS1 delay time so that the drive can travel the complete OFF3 ramp, and close any motor holding brake before the torque is safely switched off.

The OFF3 ramp-down time must be orientated to the actual braking capacity of the system or machine.

Use the following procedure to select the SS1 delay time:

- SS1 delay time with parameterized motor holding brake
 $\text{SS1 delay time (p9652)} \geq \text{OFF3 ramp-down time (p1135)} + \text{pulse suppression delay time (p1228)} + \text{motor holding brake closing time (p1217)}$
- SS1 delay time, without parameterized motor holding brake:
 $\text{SS1 delay time (p9652)} \geq \text{OFF3 ramp-down time (p1135)} + \text{pulse suppression delay time (p1228)}$

Parameterize the Emergency Stop function using the "SI SS1 delay time":

- SS1 delay time = 0 → STO (stop category 0 according to EN 60204-1)
- SS1 delay time ≠ 0 → SS1 (stop category 1 according to EN 60204-1)

4.1.3 Safe Brake Control (SBC)

Overview

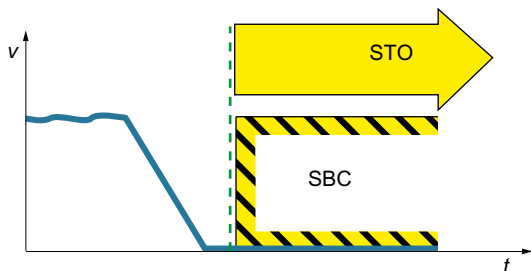

The "Safe Brake Control" function (SBC) is used to safely control the motor-integrated holding brake, which operates according to the closed-circuit principle.

Functional features

You must enable the function when commissioning in order that SBC can become active.

Note

You cannot select SBC as an autonomous function: SBC is activated (if enabled) immediately upon selection of STO.

Applications

Use SBC in applications where the drive must maintain a safe position, even when the motor is in a no-current condition. SBC thus prevents suspended or passing loads from dropping (e.g. for lifting gear, passenger elevators, winders). No external logic or switching elements required, as the functionality is completely integrated in the drive.

Note

Condition of the motor holding brake

SBC is not able to identify as to whether a holding brake is mechanically worn or is a defective.

As a consequence, observe the maximum permissible number of emergency braking operations for the motor holding brake being used.

Flow diagram

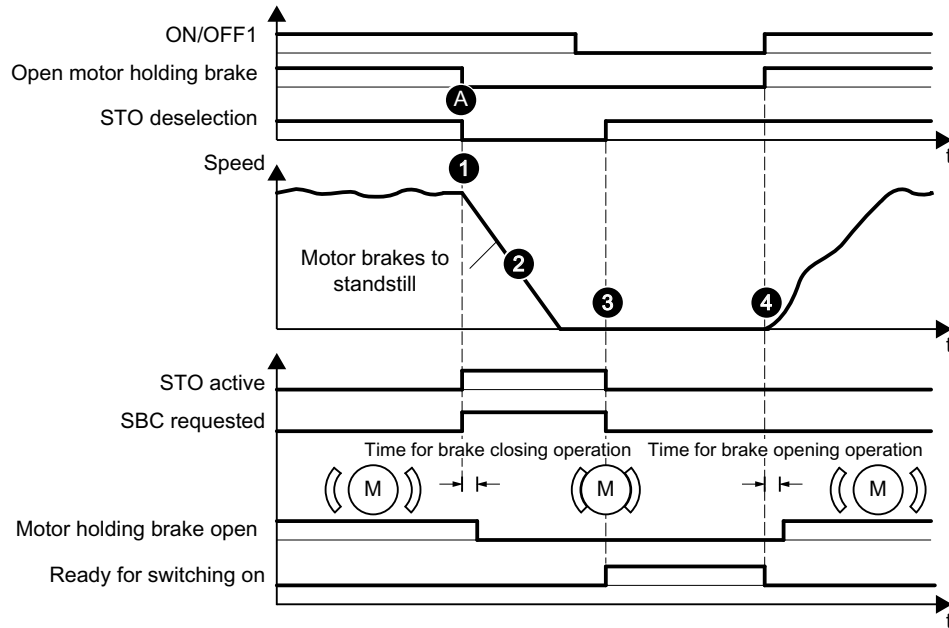

Behavior	
1	<ul style="list-style-type: none"> • STO is selected in operation. • At the same time, the drive activates SBC. • Taking the brake closing time into account, the command to close the motor holding brake closes the brake, thus supporting the shutdown process initiated by STO.
2	<ul style="list-style-type: none"> • The mechanical brake brakes the motor to a standstill.
3	<ul style="list-style-type: none"> • STO is deactivated by the drive with (manual or automatic program-controlled) deselection. • The drive is again "ready for switching on". • SBC is also simultaneously deactivated with deselection of STO. The brake remains (unsafely) closed, however, until the standard program executes the command to open the brake
4	<ul style="list-style-type: none"> • You restart the drive with a positive signal edge at ON/OFF1. Taking the brake opening time into account, the command to open the brake opens the brake.

Settings	
A	<ul style="list-style-type: none"> • STO is selected via the control bit of the selected PROFIsafe telegram or via the F-DI. • The drive activates SBC when the safe brake control is enabled (p9602 = 1). • The drive triggers SBC simultaneously with STO. • Brake management is resulted within the context of standard parameterization of the drive.

The drive adopts a controlling function for the "Safe Brake Control" function and ensures the following behavior:

- If the drive detects a fault or failure of the brake, it deactivates the brake current.
- The brake closes and a safe state is reached.



WARNING

Danger to life as a result of undesirable motor motion due to a defective brake

"Safe Brake Control" function does not detect mechanical defects of the brake.

An interrupted cable or a short-circuit in the brake winding is only detected when the state changes, i.e. when the brake either opens or closes.

The defects described above may initiate unwanted motor motion, which may result in injury or death.

- In particular, ensure the brake is not powered from an external source. Information on this topic can be found in EN 61800-5-2:2007, Appendix D.
- During commissioning, test the brake using the Safety Integrated Extended Function "Safe Brake Test (SBT)": Additional information is provided in Chapter "Safe Brake Test (SBT) (Page 110)".

4.2 Extended Functions

The Extended Functions are not included in the standard scope of the converter.

You need a license to be able to use the Extended Functions. With a license, you can use all of the Extended Functions of the converter. You require a license for each converter.

Details on the licenses are provided in the following section:

 Using functions that require a license (Page 248)

Overview of the Extended Functions

- Safe Torque Off (STO)
- Safe Stop 1 (SS1)
- Safe Brake Control (SBC)
- Safe Operating Stop (SOS with SAM or SBR)
- Safe Stop 2 (SS2)
- Safely-Limited Speed (SLS)
- Safe Speed Monitor (SSM)
- Safe Direction (SDI)
- Safely-Limited Acceleration (SLA)
- Safe Brake Test (SBT) **diagnostic function**

You select Extended Functions via the F-PLC. You can also select the STO or SS1 functions via the failsafe digital input.

 Safety settings in the web server (Page 211)

In order to be able to select the functions via the F-PLC, the communication must be configured in the F-PLC via PROFIsafe.

Details regarding the settings can be obtained in the following sections:

 Configuring safety functions (Page 118)

 Establishing communication of the converter with the controller (Page 73)

The Safety Integrated Functions are executed with a safety monitoring cycle of 4 ms.

4.2.1 Safe Torque Off (STO)

The response of STO is identical with Basic and Extended Functions: See Chapter "Safe Torque Off (STO) (Page 77)"

4.2.2 Safe Brake Control (SBC)

The response of SBC is identical with Basic and Extended Functions: See Chapter "Safe Brake Control (SBC) (Page 84)"

4.2.3 Safe Stop 1 (SS1)

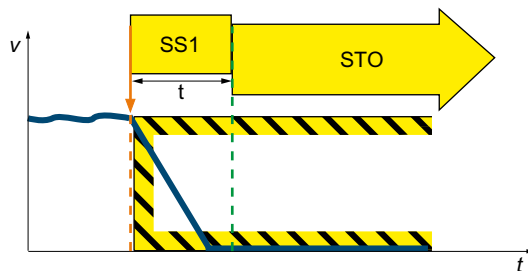

The "Safe Stop 1" function (SS1, time-controlled) causes a drive-autonomous deceleration of the motor and initiates the "Safe Torque Off" (STO) function after a predefined time interval has elapsed. This function corresponds to stop category 1 to EN 60204-1.

Functional features

The Safety Integrated Extended Function "Safe Stop 1" is available in the following versions:

- SS1-a with acceleration monitoring (SAM)
- SS1-r with braking ramp monitoring (SBR)

Set the SS1 response for Safety commissioning in the "Parameterization" step.

Note

Braking operation for SS1

When SS1 is selected, the drive brakes the motor along a braking ramp. In addition to the braking function along the OFF3 ramp integrated in the drive, you can also stop the drive using a user program in a higher-level control system (function SS1E).

Applications

SS1 can be applied in the following cases:

- The load torque does not reduce the motor to a standstill through friction within a sufficiently short time.
- Coasting down of the drive (STO) will pose risks to safety.

4.2.3.1 Safe Stop 1 with acceleration monitoring (SS1-a)

Flow diagram

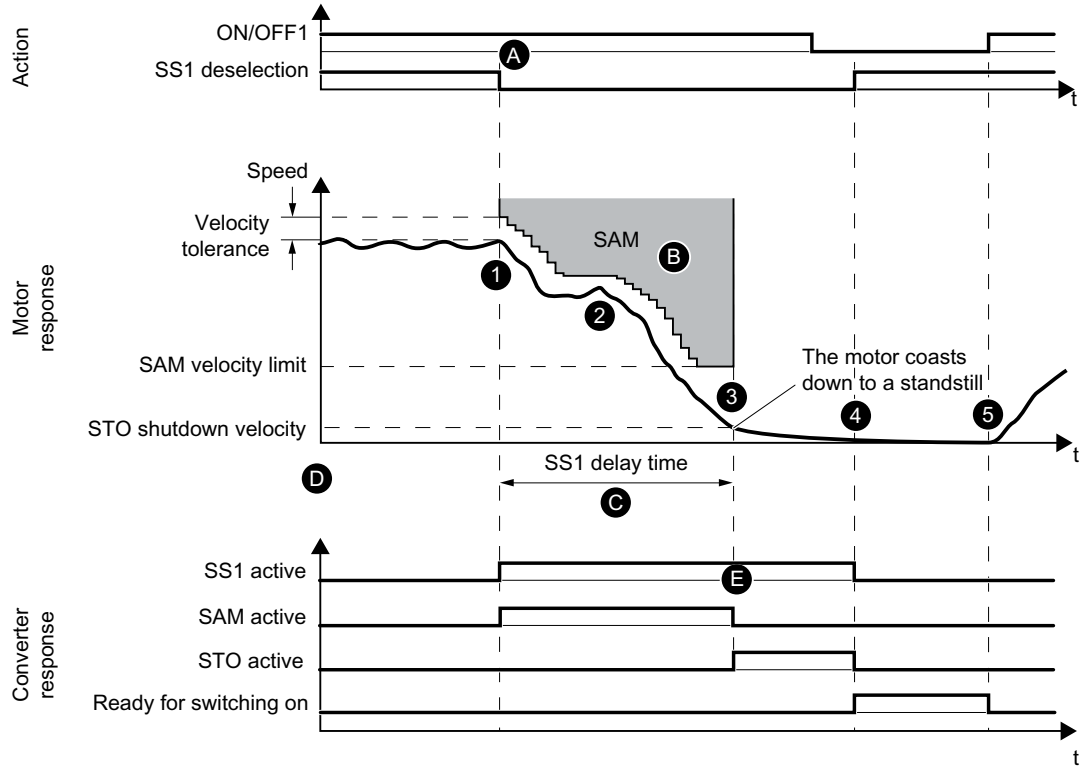

Behavior	
1	<ul style="list-style-type: none"> SS1 is selected in operation.
2	<ul style="list-style-type: none"> The drive immediately initiates braking following the response time via the OFF3 ramp. At the same time, safe acceleration monitoring (SAM) is activated. The drive monitors the speed of the motor and prevents the motor from re-accelerating by continuously adjusting the monitoring threshold to the decreasing speed.
3	<ul style="list-style-type: none"> STO is triggered upon reaching the STO shutdown speed or once the SS1 delay time has elapsed. The motor coasts down to a standstill. STO safely prevents the motor restarting.
4	<ul style="list-style-type: none"> STO and SS1 are deactivated by the drive with (manual or automatic program-controlled) deselection. The drive is again "ready for switching on".
5	<ul style="list-style-type: none"> You restart the drive with a positive signal edge at ON/OFF1.

Settings	
A	<ul style="list-style-type: none"> SS1 is selected via the control bit of the selected PROFIsafe telegram or via the F-DI.
B	<ul style="list-style-type: none"> You set the acceleration monitoring with the speed tolerance (p9548). As long as the speed reduces, the drive continuously adds the speed tolerance to the current speed so that the monitoring tracks the speed. The monitoring is deactivated when the SAM speed limit is fallen below (p9568).
C	<ul style="list-style-type: none"> In parallel to monitoring the acceleration, while braking along the OFF3 ramp you can apply the SS1 delay time (p9556). You set this time analogous to the SS1-t delay time of the Basic Functions. Once this time has expired, the drive automatically triggers STO independently of the current speed.
D	<ul style="list-style-type: none"> When the SS1 delay time (p9556) elapses OR if the speed falls below the STO shutdown speed (p9560), then the drive triggers STO.
E	<ul style="list-style-type: none"> The "SS1_active" status is signaled in the status bit of the PROFIsafe telegram. You can utilize this status in the higher-level controller. If STO is active, the "STO_active" status is also signaled in the corresponding status bit of the PROFIsafe telegram.

4.2.3.2 Safe Stop 1 with braking ramp monitoring (SS1-r)

Flow diagram

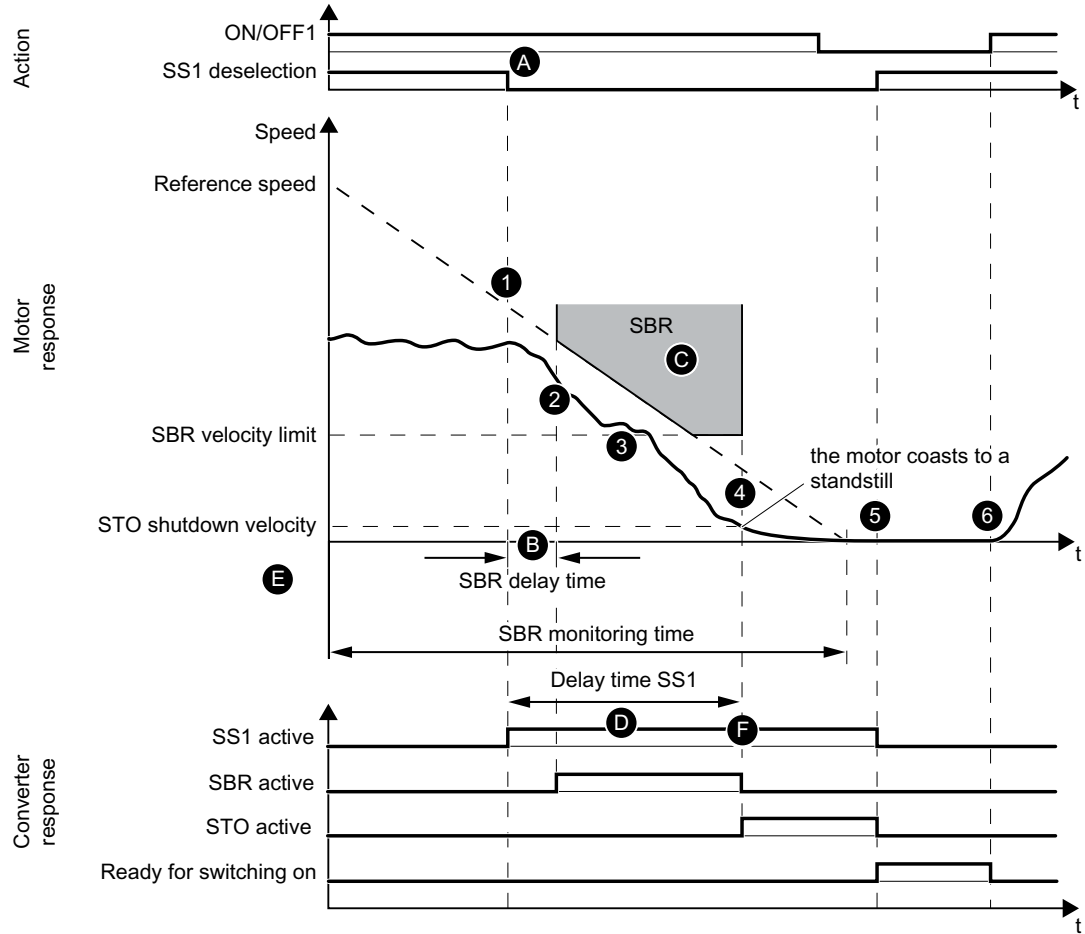

Behavior	
1	<ul style="list-style-type: none"> SS1 is selected in operation.
2	<ul style="list-style-type: none"> The drive immediately initiates braking following the response time via the OFF3 ramp. At the same time, the drive initiates the SBR delay time.
3	<ul style="list-style-type: none"> The drive monitors the motor to ensure that it does not exceed the set braking ramp when braking. Upon reaching the SBR speed limit, the drive deactivates monitoring of the braking ramp. Braking continues.
4	<ul style="list-style-type: none"> STO is triggered by the drive when the STO shutdown speed is reached or when the SS1 delay time has elapsed. The motor coasts down to a standstill. The drive safely prevents a restart of the motor with the pulse inhibit.

4.2 Extended Functions

5	<ul style="list-style-type: none"> • STO and SS1 are deactivated by the drive with (manual or automatic program-controlled) deselection. • The drive is again "ready for switching on".
6	<ul style="list-style-type: none"> • You restart the drive with a positive signal edge at ON/OFF1.

Settings	
A	<ul style="list-style-type: none"> • SS1 is selected via the control bit of the selected PROFIsafe telegram or via the F-DI.
B	<ul style="list-style-type: none"> • The drive initiates the SBR delay time (p9582) with selection of SS1. • Monitoring of the braking ramp is initiated by the drive when the delay time has elapsed.
C	<ul style="list-style-type: none"> • You set the braking ramp with the reference speed (p9581) and the SBR monitoring time (p9583). • The drive deactivates monitoring of the braking ramp if speed falls below the SBR speed limit (p9568).
D	<ul style="list-style-type: none"> • In parallel to monitoring the braking ramp, while braking along the OFF3 ramp, you can apply the SS1 delay time (p9556). When this time elapses, the drive automatically triggers STO independently of the current speed.
E	<ul style="list-style-type: none"> • When the SS1 delay time (p9556) elapses OR if the speed falls below the STO shutdown speed (p9560), then the drive triggers STO.
F	<ul style="list-style-type: none"> • The drive signals the "SS1_active" status in the status bit of the PROFIsafe telegram. • You can utilize this status in the higher-level controller. • If STO is active, the drive also signals the "STO_active" status in the corresponding status bit of the PROFIsafe telegram.

4.2.4 Safe Stop 2 (SS2)

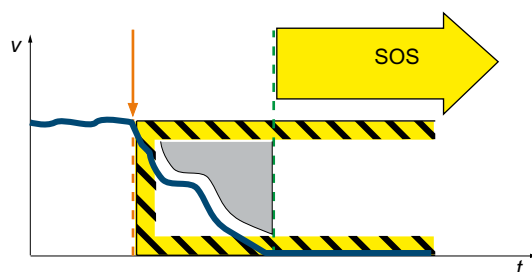

The SS2 function brings the motor to a standstill with subsequent safe monitoring of the standstill position. When SS2-r is selected, the drive brakes the motor along a braking ramp. In addition to the braking function along the OFF3 ramp integrated in the drive, you can also stop the drive using a user program in a higher-level control system (function SS2E).

SS2 distinguishes the following variants:

- SS2-a with acceleration monitoring (SAM)
- SS2-r with braking ramp monitoring (SBR)
- Additionally, SS2 can be parameterized with a delay time before activation of SOS.

Selection and monitoring of the acceleration (SAM) and the braking ramp (SBR) are realized with two channels. Braking with the OFF3 ramp is realized with one channel.

Interruption of the ramp function with OFF2

Activating SS2 can mean that the higher-level controller (PLC, motion controller) which specifies the speed setpoint, interrupts the ramp function (e.g. with OFF2). The device behaves in this way as a result of a fault response triggered by OFF3 activation. This fault reaction must be prevented by way of appropriate parameterization/configuration.

Note

If a higher-level motion controller is used, Safety function SS2E or SOS should be applied.

Reason: With Safety function SS2-r/SS2-a, SINAMICS S210 brakes autonomously along the OFF3 ramp. The motion controller detects a deviation between target value and actual value and shifts the drive to pulse cancellation.

Applications

Use the SS2 for applications where an axis must be safely stopped and where the standstill position must then be safely monitored. Following deselection of SS2, you can continue traversing the axis without reference point approach.

4.2.4.1 SS2 with acceleration monitoring (SS2-a)

Flow diagram

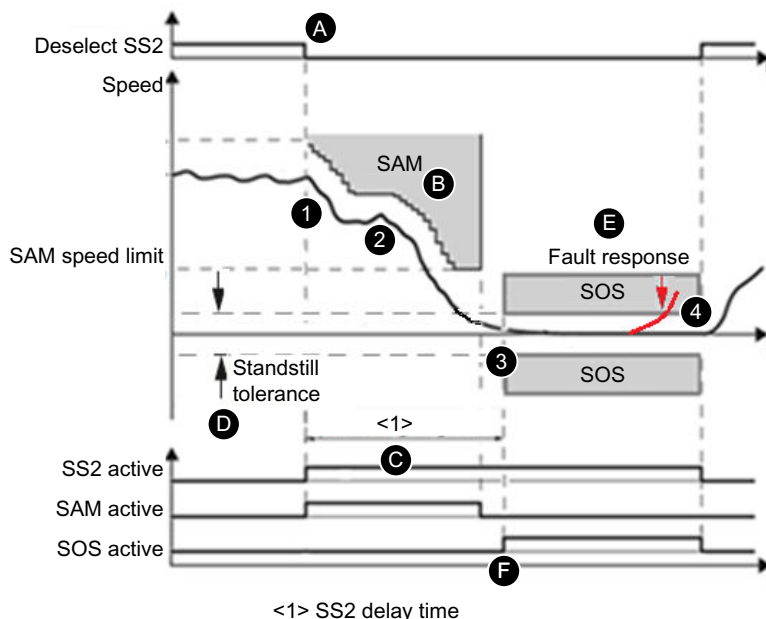

Behavior	
1	<ul style="list-style-type: none"> SS2 is selected during operation.
2	<ul style="list-style-type: none"> The drive immediately initiates braking following the response time via the OFF3 ramp. At the same time, the drive activates safe acceleration monitoring (SAM). The drive monitors the speed of the motor and prevents the motor from re-accelerating by continuously adjusting the monitoring threshold to the decreasing speed.
3	<ul style="list-style-type: none"> SOS is triggered once the SS2 delay time has elapsed. The SS2 delay time set must allow the drive to brake to a standstill from every speed of the operating process within this time. The drive safely monitors standstill of the motor with the Safety function SOS. The motor remains in control mode.
4	<ul style="list-style-type: none"> SS2 and SOS are deactivated by the drive with (manual or automatic program-controlled) deselection. You can immediately continue traversing the axis from the standstill position.

Settings	
A	<ul style="list-style-type: none"> SS2 is selected via the control bit of the selected PROFIsafe telegram.
B	<ul style="list-style-type: none"> The acceleration monitoring SAM is set with the speed tolerance (p9548). SINAMICS S210 monitors the change in speed between 2 safety monitoring cycles to ensure that it does not exceed the speed tolerance (p9548). The monitoring is deactivated when the SAM speed limit is fallen below (p9568).
C	<ul style="list-style-type: none"> Standstill is safely monitored (SOS becomes active) once the SS2 delay time (p9552) has elapsed.

D	<ul style="list-style-type: none">• The drive is in control mode and monitors the standstill tolerance (p9530).
E	<ul style="list-style-type: none">• If the standstill tolerance is violated, the drive executes SS1 as a stop reaction with subsequent transition to STO.
F	<ul style="list-style-type: none">• The "SS2_active" status is signaled in the status bit of the PROFIsafe telegram.• You can utilize this status in the higher-level controller.• If SOS is active, the drive also signals "SOS_active" in the corresponding status bit of the PROFIsafe telegram.

4.2.4.2 SS2 with braking ramp monitoring (SS2-r)

Flow diagram

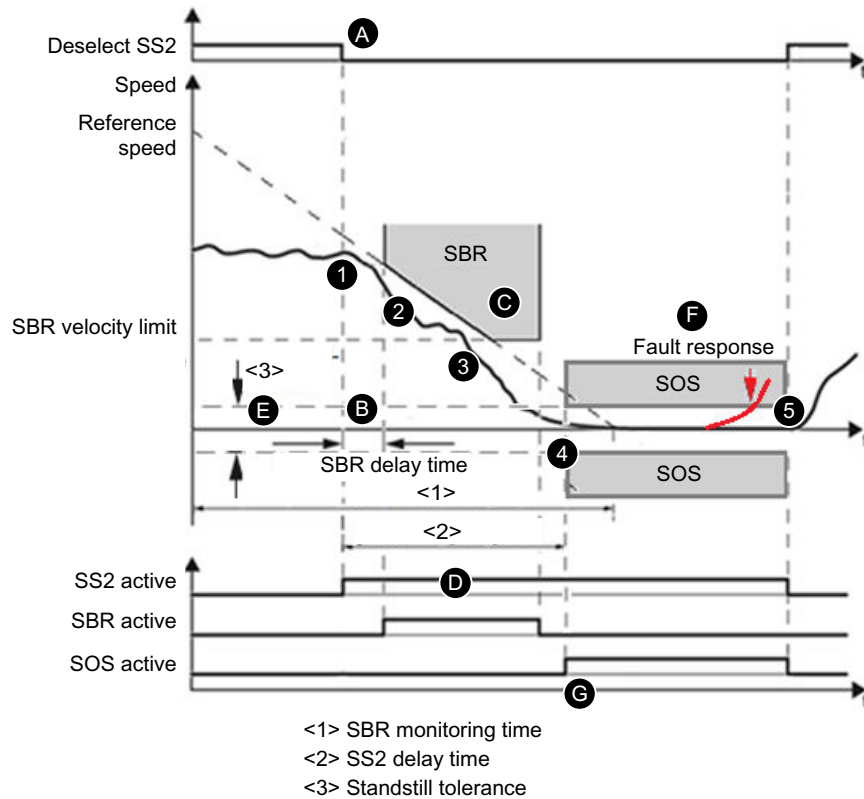

Behavior	
1	<ul style="list-style-type: none"> SS2 is selected during operation.
2	<ul style="list-style-type: none"> The drive immediately initiates braking following the response time via the OFF3 ramp. The SBR delay time is initiated at the same time.
3	<ul style="list-style-type: none"> The drive monitors the motor to ensure that it does not exceed the set braking ramp when braking. Upon reaching the SBR speed limit, monitoring of the braking ramp is deactivated. Braking continues.
4	<ul style="list-style-type: none"> SOS is triggered once the SS2 delay time has elapsed. The SS2 delay time set must allow the drive to brake to a standstill from every speed of the operating process within this time. Standstill of the motor safely monitored with Safety function SOS. The motor remains in control mode.
5	<ul style="list-style-type: none"> SS2 and SOS are deactivated with (manual or automatic program-controlled) deselection. You can immediately continue traversing the axis from the standstill position.

Settings	
A	<ul style="list-style-type: none"> SS2 is selected via the control bit of the selected PROFIsafe telegram.
B	<ul style="list-style-type: none"> The SBR delay time (p9582) is initiated with selection of SS2. Monitoring of the braking ramp is initiated once the delay time has elapsed.
C	<ul style="list-style-type: none"> You set the braking ramp with the reference speed (p9581) and the SBR monitoring time (p9583). The drive deactivates monitoring of the braking ramp if speed falls below the SBR speed limit (p9568).
D	<ul style="list-style-type: none"> Standstill is safely monitored (SOS becomes active) once the SS2 delay time (p9552) has elapsed.
E	<ul style="list-style-type: none"> The drive is in control mode and monitors the standstill tolerance (p9530).
F	<ul style="list-style-type: none"> If the standstill tolerance is violated, then the drive responds with SS1 and then transitions into STO.
G	<ul style="list-style-type: none"> The "SS2_active" status is signaled in the status bit of the PROFIsafe telegram. This value can be applied in the higher-level controller. If SOS is active, the "SOS_active" status is also signaled in the corresponding status bit of the PROFIsafe telegram.

4.2.5 Safe Operating Stop (SOS)

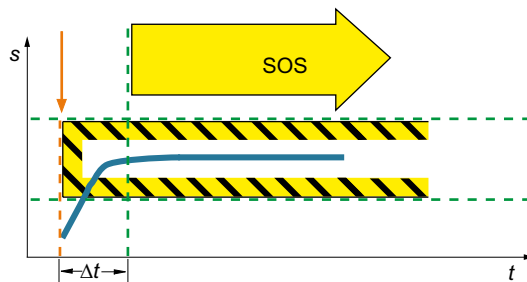

When SOS is selected, the drive safely monitors the drive position for standstill. The drive is in the closed-loop control mode, and can therefore withstand external forces.

After SOS has been selected it becomes active after the parameterizable delay time has expired. The drive must be braked to standstill within this delay time, e.g. by the controller.

Applications

SOS is suitable for the following applications:

- Machine parts must be safely monitored that they actually are at a standstill.
- A holding torque is required.

Flow diagram

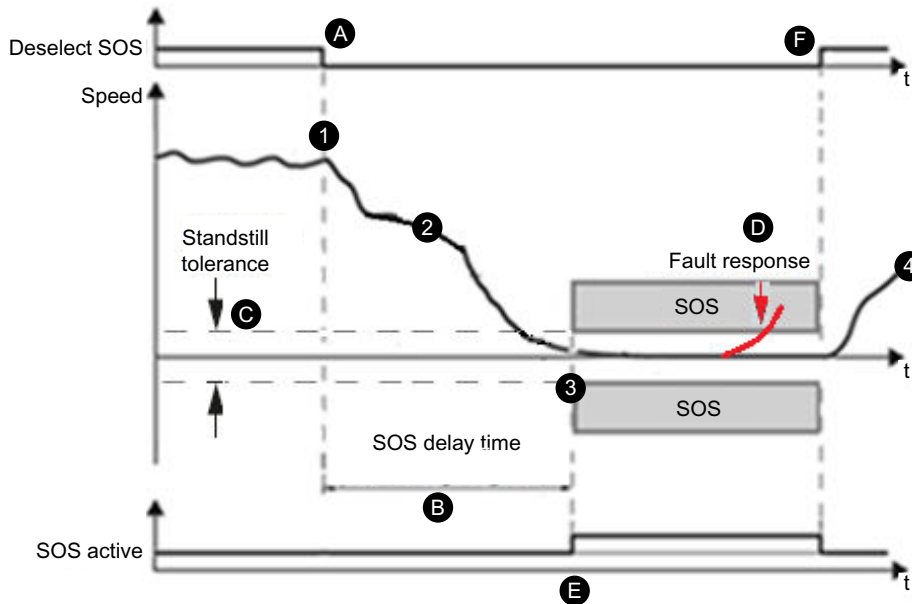

Behavior	
1	<ul style="list-style-type: none"> SOS is selected during operation.
2	<ul style="list-style-type: none"> The control system initiates stopping using the setpoint that is entered. At the same time, the drive initiates the SOS delay time.
3	<ul style="list-style-type: none"> SOS is triggered when the SOS delay time elapses. The SOS delay time set must allow the drive to brake to a standstill from every speed of the operating process within this time. The motor is then safely monitored in the standstill position.
4	<ul style="list-style-type: none"> SOS is deactivated by the drive with (manual or automatic program-controlled) deselection. You can immediately continue traversing the axis from the standstill position.

Settings	
A	<ul style="list-style-type: none"> SOS is selected via the control bit of the selected PROFIsafe telegram.
B	<ul style="list-style-type: none"> The drive is braked by external setpoint value specification. SOS becomes active when the SOS delay time (p9551) has elapsed.
C	<ul style="list-style-type: none"> The drive is in control mode and monitors the standstill tolerance (p9530).
D	<ul style="list-style-type: none"> If the standstill tolerance is violated, then the drive responds with SS1 and then transitions into STO.
E	<ul style="list-style-type: none"> The "SOS active" status is signaled in the status bit of the PROFIsafe telegram. You can utilize this status in the higher-level controller.
F	<ul style="list-style-type: none"> Monitoring of the position window is concluded with "Deselect SOS" via the control bit of the selected PROFIsafe telegram. The drive may be operated freely.

Contrary to SS1 and SS2, SOS does not automatically brake the drive.

The control still enters the setpoint.

The response to "Deselect SOS" in the user program of the control must ensure that the control brings the drive to a standstill within the delay time.

WARNING

Drive can be forced out of the SOS position by mechanical forces

A drive under position control can be forced out of the "Safe Operating Stop" (SOS) position by mechanical forces that are greater than the maximum torque of the drive. This unwanted drive movement then triggers a Category 1 Stop function according to EN 60204-1 (fault response function STOP B). The alarms for SS1 and STO must be observed.

- If there is a hazard due to unwanted motion in your application, take measures to counter it, for example, by using a brake with safe monitoring. Additional information is provided in Chapter "Safe Brake Control (SBC) (Page 84)".

Note

Size of the tolerance window

The size of the tolerance window must be adapted to the respective application, otherwise the standard monitoring functions will no longer be effective.

4.2.6 Safely-Limited Speed (SLS)

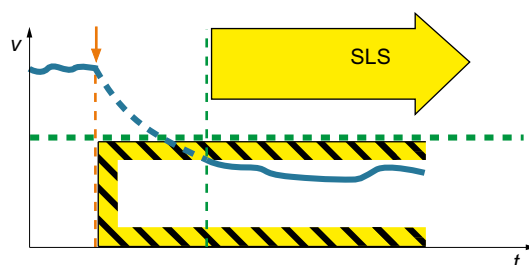

The drive with active SLS function monitors speed/velocity of the motor to ensure that it does not exceed the speed/velocity threshold valid for the SLS (SLS monitoring).

The SLS function prevents the parameterized maximum velocity from being exceeded. If the permitted speed is exceeded, then the drive initiates a parameterizable stop response. It is possible to switch between 4 different limit value levels in operation. Additionally, you can specify variable limit values during operation via PROFI-safe.

Applications

SLS is suitable for machines susceptible to hazardous situations if a speed is exceeded and wherever work must be performed directly on a machine, for example:

- During operation
- In setup mode
- For maintenance work

4.2.6.1 SLS with a speed level

Flow diagram

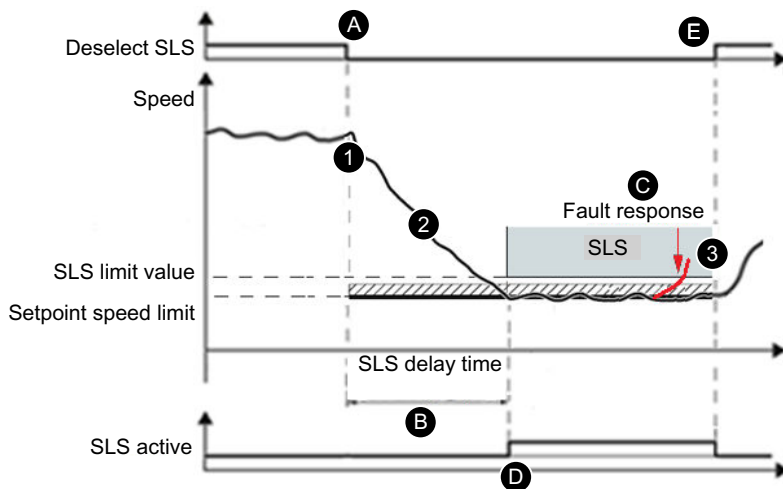

Behavior	
1	<ul style="list-style-type: none"> SLS is selected during operation. The speed is higher than the SLS limit value. The drive initiates the SLS delay time.
2	<ul style="list-style-type: none"> The actual speed must remain below the SLS limit value until the SLS delay time has elapsed. Monitoring becomes effective once the SLS delay time has elapsed (e.g. in the "Setup" operating mode).
3	<ul style="list-style-type: none"> SLS is deactivated by the drive with (manual or automatic program-controlled) deselection. You can continue traversing the axis immediately with greater setpoints (e.g. changing over to "Automatic" mode).

Settings	
A	<ul style="list-style-type: none"> SLS is selected via the control bit of the selected PROFIsafe telegram.
B	<ul style="list-style-type: none"> The drive is braked by external setpoint value specification. Monitoring of the SLS limit value (level 1 = p9531[0]) becomes effective once the SLS delay time (p9551) has elapsed.
C	<ul style="list-style-type: none"> If the SLS limit value is violated, the drive executes the set stop reaction (level 1 = p9563[0]).
D	<ul style="list-style-type: none"> The drive signals the "SLS active" status in the status bit of the PROFIsafe telegram. You can utilize this status in the higher-level controller.
E	<ul style="list-style-type: none"> The drive ends monitoring of the SLS limit value with deselection of SLS via the control bit of the selected PROFIsafe telegram. The drive may be operated freely.

4.2.6.2 SLS with switchover of speed levels

Flow diagram

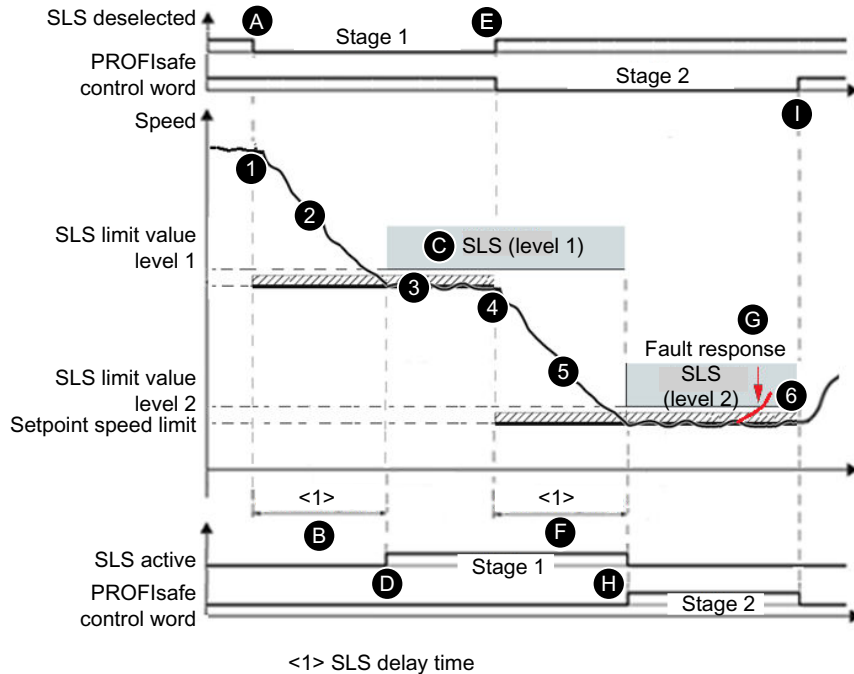

Behavior	
1	<ul style="list-style-type: none"> SLS level 1 is selected during operation. The speed is higher than the SLS limit value. The drive initiates the SLS delay time.
2	<ul style="list-style-type: none"> The actual speed must remain below the SLS limit value level 1 until the SLS delay time has elapsed. Monitoring of level 1 becomes active once the SLS delay time has elapsed.
3	<ul style="list-style-type: none"> The SLS limit value level 1 can be evaluated with the relative setpoint speed limit and made available as a setpoint limit.
4	<ul style="list-style-type: none"> Switchover to SLS level 2 is initiated subsequently in the process.
5	<ul style="list-style-type: none"> When changing over to a lower limit value, the SLS delay time is (re)started. The actual speed must remain below the SLS limit value level 2 until this delay time has elapsed. The existing limit remains active during the delay time. The lower limit value becomes active and monitoring of SLS level 2 becomes effective once the SLS delay time has elapsed.
6	<ul style="list-style-type: none"> SLS is deactivated by the drive with (manual or automatic program-controlled) deselection. You can continue traversing the axis immediately with greater setpoints (e.g. changing over to "Automatic" mode).

Settings	
A	<ul style="list-style-type: none"> SLS (level 1) is selected via the control bit of the selected PROFIsafe telegram.

4.2 Extended Functions

B	<ul style="list-style-type: none"> The drive is braked by external setpoint value specification. The SLS limit value (level 1 = p9531[0]) is monitored once the SLS delay time (p9551) has elapsed.
C	<ul style="list-style-type: none"> If the SLS limit value (level 1) is violated, the drive executes the set stop response (level 1 = p9563[0]).
D	<ul style="list-style-type: none"> The drive signals the "SLS active (level 1)" status in the status bit of the PROFIsafe telegram. You can utilize this status in the higher-level controller.
E	<ul style="list-style-type: none"> Switchover to SLS (level 2) is performed via the control bit of the selected PROFIsafe telegram.
F	<ul style="list-style-type: none"> The drive is braked by external setpoint value specification. Monitoring of the SLS limit value (level 2 = p9531[1]) becomes effective once the delay time for SLS switchover = SLS delay time (p9551) has elapsed.
G	<ul style="list-style-type: none"> If the SLS limit value (level 2) is violated, the drive executes the set stop response (level 2 = p9563[1]).
H	<ul style="list-style-type: none"> The SLS active (level 1 and level 2) statuses are signaled in the status bits of the PROFIsafe telegram. You can utilize these values in the higher-level controller.
I	<ul style="list-style-type: none"> The drive ends monitoring of the SLS limit value with deselection of SLS (level 2) via the control bit of the selected PROFIsafe telegram. The drive may be operated freely.

4.2.6.3 SLS with variable speed limit value

SINAMICS offers the option of influencing the first SLS limit value via PROFIsafe:

- The transfer of the first SLS limit value via PROFIsafe is active if the speed level 1 in the PROFIsafe telegram is selected and the bit "Enable transfer SLS limit value via PROFIsafe" (p9501.24) is set.
- S_SLS_LIMIT_A has the value range 1 ... 32767; the following applies:
 - $32767 \triangleq 100\%$ of the 1st SLS level
 - The actually monitored limit value is calculated as follows:
SLS limit value = $(S_SLS_LIMIT_A/32767) \cdot p9531[0]$
- Speed levels 2, 3 and 4 can also be parameterized and selected in this case.
- The selected delay time cannot be changed during operation. If you require various delay times in your application, then you must realize this requirement using a time-delayed transfer of the SLS limit value using your control system (F-CPU).
- If an incorrect SLS limit value is transferred, the drive responds with the stop response parameterized in p9563 for speed level 1 and Safety alarm A01711.

4.2.6.4 Additional functional features

Setpoint speed limit and SLS

It makes sense to configure the set velocity limit if SLS is also parameterized. This configuration is realized, for example in a higher-level control that evaluates the Safety Info Channel.

In parameter "SI Motion SLS setpoint speed limiting" (p9533) enter the weighting factor to determine the setpoint limit from the selected actual speed limit in percent. The active limit value is evaluated using this factor, and is made available as "Setpoint speed limit effective" (r9733).

- $r9733[0] = p9531[x] \cdot p9533$ (converted from the load to the motor side)
- $r9733[1] = -p9531[x] \cdot p9533$ (converted from the load to the motor side)
[x] = selected SLS stage

Conversion factor from the motor to the load side:

- Motor type = rotary and axis type = linear: $p9522/(p9521 \cdot p9520)$
- Otherwise: $p9522/p9521$

SLS limit value

- $r9733[0] = p9531[x] \cdot p9533$
- $r9733[1] = -p9531[x] \cdot p9533$
[x] = selected SLS limit value

"Setpoint speed limit effective" r9733 is used, for example, for transferring values to a higher-level control, which can then, for example, adjust traversing speeds to the SLS levels. r9733 is a part of the Safety Info Channel (SIC).

Toggling between SLS limit values

The changeover is performed binary-coded via 2 PROFIsafe control bits. The speed selection statuses can be checked using parameters "Select SLS bit 0" and "Select SLS bit 1" (r9720.9 and r9720.10). The actual speed limit value is indicated using parameters "Active SLS level bit 0" and "Active SLS level bit 1" (r9722.9 and r9722.10), "SLS active" (r9722.4) must be a "1".

Switchover to another stage may also be performed with time delay. This corresponds to the processes from "SLS with one speed level" with a different respective SLS stage.

When changing over from a lower to a higher limit value, the delay time is not effective: The higher limit value immediately becomes active.

Response in the event of a communication error

If the "Stop response delay bus failure" (p9580) $\neq 0$ and SLS is active, in the event of communication failure, the parameterized ESR reaction is only realized if, as SLS response, a stop reaction with delayed pulse cancellation when the bus fails has been parameterized ($p9563[0...3] \geq 10$).

4.2.7 Safe Speed Monitor (SSM)

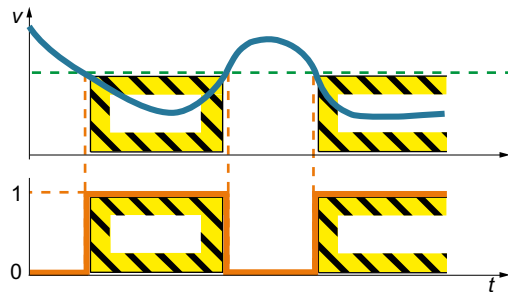

The Safe Speed Monitor function is used for safely identifying when a speed limit is fallen below in both directions of rotation, e.g. to identify zero speed.

The drive provides a safe output signal for further processing.

Applications

SSM is suitable for the realization of enabling access to the machine by way of safe SSM feedback. For example, to ensure that protective doors can only be unlocked when the critical speeds fall below those specified.

Flow diagram

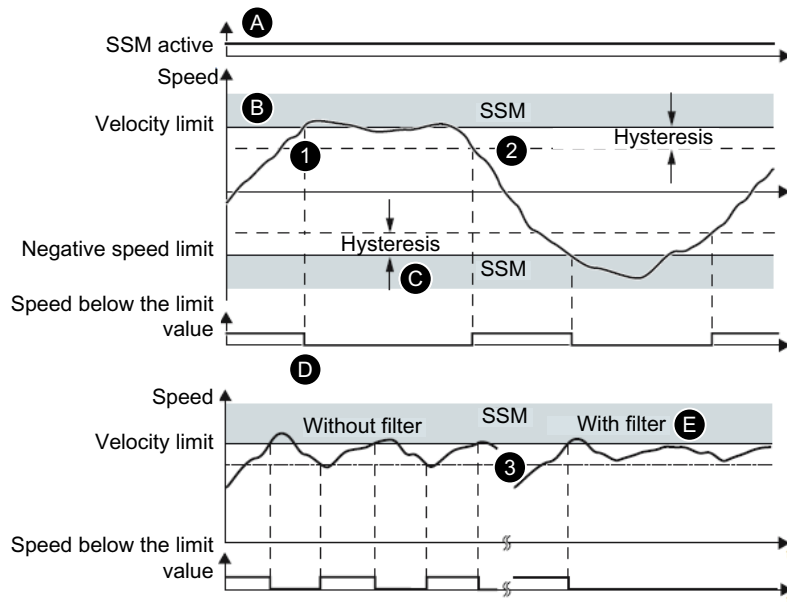

Behavior	
1	<ul style="list-style-type: none"> Function SSM is enabled with p9501.16. If the speed falls below the speed limit, the "Speed below limit value" signal is set. If the speed is greater than the limit, the "Speed below limit value" is not set.

4.2 Extended Functions

2	<ul style="list-style-type: none"> The parameterizable hysteresis ensures that a stable signal characteristic is achieved for speeds close to the monitoring threshold: This ensures that the SSM output signal does not jump between the values "0" and "1" in the limit range. When "hysteresis and filtering" is activated with output signal SSM, a time-delayed SSM feedback signal occurs for the axes. This is a characteristic of the filter.
3	<ul style="list-style-type: none"> The signal filter smoothes the speed measured by the drive. Use the filter if you wish to monitor speeds that lie just below the speed limit.

Settings	
A	<ul style="list-style-type: none"> The function is activated automatically as soon as the Safety Integrated Extended Functions (p9501.0 = 1) are enabled - and the enable for SSM with hysteresis and filtering is set (p9501.16 = 1).
B	<ul style="list-style-type: none"> The speed limit (p9546) is effective in both directions of rotation. The SSM function is deactivated with the setting speed limit = 0.
C	<ul style="list-style-type: none"> The speed hysteresis (p9547) stabilizes the output signal speed below limit value. The speed hysteresis must be $\leq 0.75 \cdot \text{speed limit}$.
D	<ul style="list-style-type: none"> The "Speed below limit value" status is signaled in the status bit of the PROFIsafe telegram. You can utilize this status in the higher-level controller.
E	<ul style="list-style-type: none"> You set the response with the filter time (p9545).

SSM is a pure signaling function

Contrary to other Safety Integrated Functions, a violation of the SSM limit does not result in a drive-based stop response.

Relationship between SSM and SAM

If 0 is entered for p9568 (SAM shutdown threshold), the speed limit of the SSM function (p9546) is simultaneously the lower limit for the Safe Acceleration Monitor function (SAM).

In this case, the effects of safe acceleration monitoring are therefore restricted if a relatively high SSM speed limit is set when using the SS1 and SS2 stop functions.

4.2.8 Safe Direction (SDI)

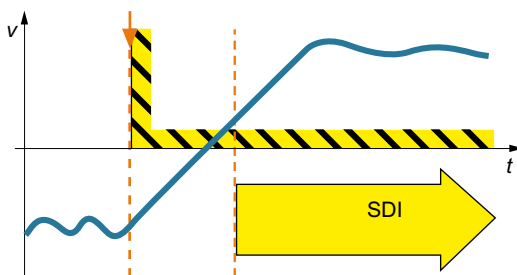

The drive with active SDI function monitors the motor's direction of rotation. If the motor rotates in the impermissible direction, the drive stops the motor as quickly as possible.

Applications

SDI is suitable for the following cases:

- Machines on which cyclic material must be loaded and removed
- For protection against impermissible direction of rotation

Flow diagram

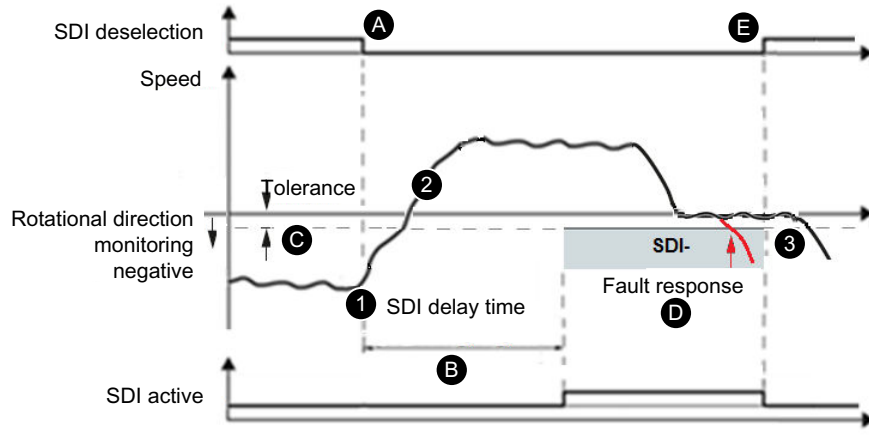

Behavior	
1	<ul style="list-style-type: none"> • SDI is selected during operation. • The drive initiates the SDI delay time.
2	<ul style="list-style-type: none"> • You must actuate the drive in the enabled safe direction until the SDI delay time has elapsed. • Monitoring of the direction of rotation becomes effective once the SDI delay time has elapsed.
3	<ul style="list-style-type: none"> • SDI is deactivated by the drive with (manual or automatic program-controlled) deselection. • You can traverse the axis immediately in both directions of rotation.

Settings	
A	<ul style="list-style-type: none"> • "Select SDI" is performed via the control bits of the selected PROFIsafe telegram.
B	<ul style="list-style-type: none"> • The drive is operated in the enabled direction via external setpoint specification. • Monitoring of the direction of rotation becomes effective once the SDI delay time (p9565) has elapsed.
C	<ul style="list-style-type: none"> • Monitoring takes the tolerance (p9564) into account.
D	<ul style="list-style-type: none"> • The drive signals the "SDI active" status in the status bit of the PROFIsafe telegram. • You can utilize this status in the higher-level controller.
E	<ul style="list-style-type: none"> • The drive ends monitoring of the direction of rotation with "Deselect SDI" via the control bit of the selected PROFIsafe telegram. • You can traverse the axis immediately in both directions of rotation.

No detection of a change in direction by means of p1821

If the direction of rotation is reversed using p1821 (direction of rotation), then safe monitoring is still possible: However, in this case, the setpoint limitation r9733 is calculated with the wrong direction of rotation. A reversal of the direction of rotation with p1821 is therefore not practical.

Response to bus failure

If p9580 ≠ 0 and SDI is active, in the event of a communication failure, the parameterized ESR reaction only occurs if a stop response with delayed pulse suppression when the bus fails has been parameterized as the SDI response (p9566[0...3] ≥ 10).

4.2.9 Safely-Limited Acceleration (SLA)



"The SLA function prevents the motor from exceeding the defined acceleration limit."

Applications

SLA is suitable for machines for which the permissible acceleration may not be exceeded, for example in setup mode.

Flow diagram

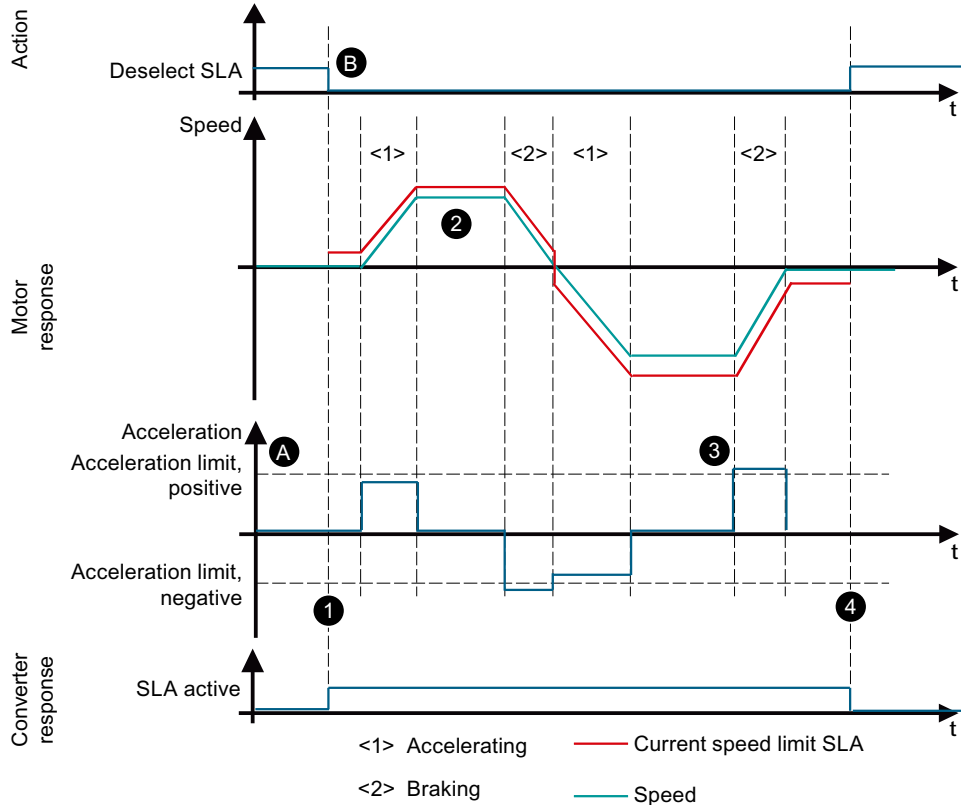

Behavior	
1	<ul style="list-style-type: none"> • SLA is selected during operation. • The drive initiates acceleration monitoring. • The drive signals the "SLA active" status in the status bit of the PROFIsafe telegram. You can utilize this status in the higher-level controller.
2	<ul style="list-style-type: none"> • When accelerating, the drive monitors to ensure that the defined acceleration limit is not exceeded.
3	<ul style="list-style-type: none"> • If SLA detects that the acceleration limit has been violated, the drive initiates the configured stop response.
4	<ul style="list-style-type: none"> • SLA is deactivated with (manual or automatic program-controlled) deselection. • If you deactivate SLA with "Deselect SLA" = 1 in the Profisafe telegram, then the drive responds by withdrawing the "SLA active" (= 0) signal. • You can traverse the axis immediately in both directions of rotation.

Settings	
A	<ul style="list-style-type: none"> • Define the maximum permissible acceleration with the acceleration limit (p9578).
B	<ul style="list-style-type: none"> • Select SLA via a control bit of the PROFIsafe telegram.

4.2.10 Safe Brake Test (SBT)

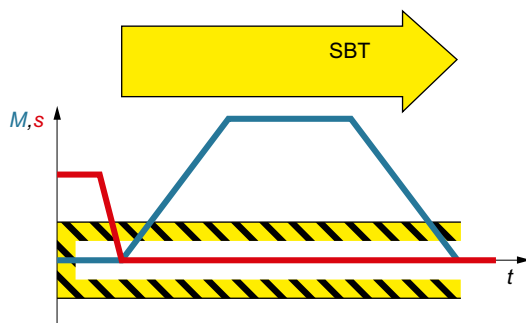

The diagnostic function "Safe Brake Test" (SBT) checks the required holding torque of a motor holding brake.

This diagnostic function exceeds the scope of EN 61800-5-2.

The drive purposely generates a force/torque against the applied brake. If the brake is operating correctly, the axis movement remains within a parameterized tolerance. However, if the drive determines higher axis motion, then this indicates that the braking force or the braking torque has diminished. In this case, maintenance work must be performed.

Applications

SBT is suitable for implementing a "safe brake" in conjunction with SBC. This allows errors or wear to be detected in the brake mechanics. Automatic testing of the braking effect reduces maintenance costs and increases safety and availability of the machine or plant.

Flow diagram

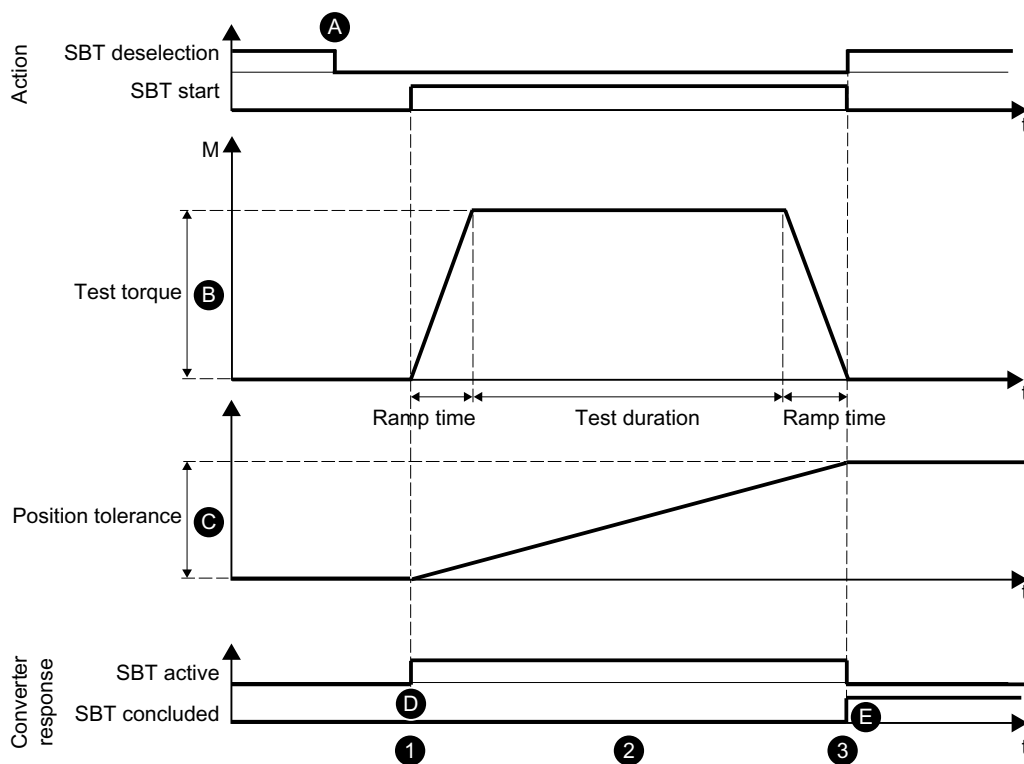

Behavior	
1	<ul style="list-style-type: none"> • SBT is selected during operation. • The drive initiates the brake test.
2	<ul style="list-style-type: none"> • The drive generates the test torque against the applied brake. If the brake is functioning correctly, motion of the axis remains within a defined tolerance. However, if a larger axis movement is identified from the encoder actual values, the brake is not in a position to provide the specified holding torque. • Service or replace the brake.
3	<ul style="list-style-type: none"> • SLS is deactivated by the drive with (manual or automatic program-controlled) deselection. • Depending on the result of the brake test, the automation program can initiate the next step.

Settings	
A	<ul style="list-style-type: none"> • Select SBT and Start SBT are implemented via the control bits of the Safety Control Channel (SCC) - in PROFIdrive telegram 701. The SBT function is thus controlled directly from a higher-level controller.
B	<ul style="list-style-type: none"> • The drive performs the brake test with the following variables: <ul style="list-style-type: none"> – Ramp time (p10208[0]) – Holding torque (p10209[0]) – Test torque = Factor (p10210[0]) – Test duration (p10211[0])
C	<ul style="list-style-type: none"> • Define the maximum permissible axis motion with the position tolerance (p10212[0]).
D	<ul style="list-style-type: none"> • The drive signals the "SBT active" status in the status bit of the SIC/SCC. • You can utilize this status in the higher-level controller.
E	<ul style="list-style-type: none"> • Once SBT is concluded, the drive withdraws the SBT selection.

Starting SBT

1. Enable
 - Selection via fieldbus (SCC)
Selection of brake test sequence with 0/1 edge in S_STW3B.0

Note

Observe sequence

With selection via fieldbus (SCC, S_STW3B.0), the sequence of steps 2 to 5 described as follows must be observed.

2. Wait for the following feedback: r10231[0] = 1
3. Select brake and test sequence.
Decide upon the following before initiating the brake test sequence:
 - Brake to be tested S_STW3B.2
 - Positive or negative direction of the test torque S_STW3B.3
 - Brake test sequence 1 or 2 S_STW3B.4

4.2 Extended Functions

4. Start brake test
Start the brake test sequence in S_STW3B.1.
5. Exit brake test
 - Withdraw the "Start brake test" in S_STW3B.1.
 - Withdraw "Select brake test" in S_STW3B.0.

4.2.11 Safe Acceleration Monitor (SAM)

The "Safe Acceleration Monitor" (SAM) function is used for safe monitoring of braking. The Safe Acceleration Monitor function is applied to monitor braking for functions SS1 and SS2 (selected directly or as a response to a limit value violation).

- As long as the speed reduces, the drive continuously adds the adjustable speed tolerance to the current speed so that the monitoring tracks the speed.
- A renewed acceleration, i.e. an increase in speed by more than the speed tolerance (p9548), will trigger the limit violation function.
- The drive continues to reduce the monitoring limit in accordance with the current speed until it has fallen below the SAM speed limit (p9568).
- If the speed does not decrease temporarily, then the drive freezes the monitoring limit until the speed again decreases.
- If the motor accelerates by the speed tolerance during the OFF3 deceleration ramp, SAM detects the process and triggers STO. Monitoring using SAM is activated for SS1 and SS2, and ends if STO or SOS take over the monitoring.

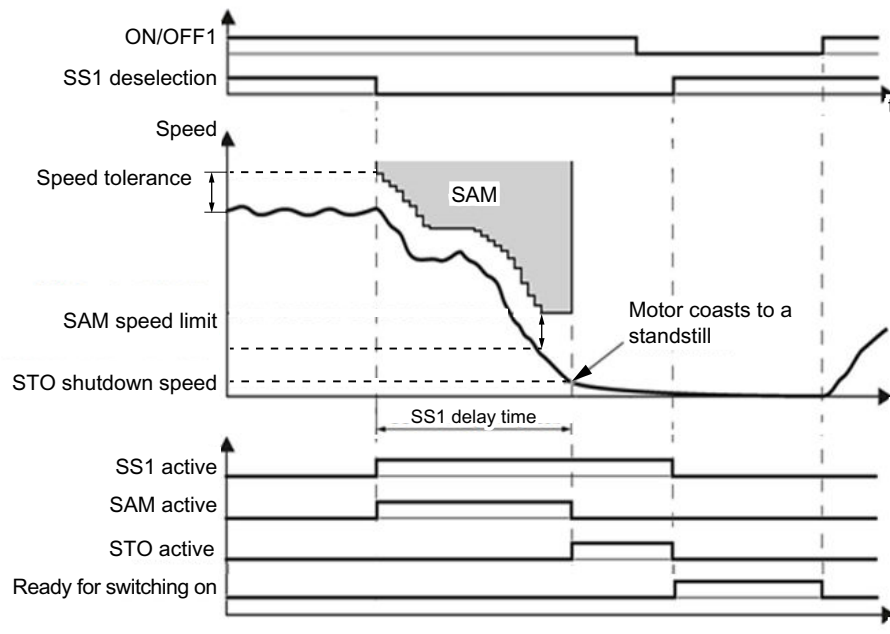

Figure 4-1 Example: SS1 with SAM

Calculating the SAM tolerance of the actual velocity

- The following applies when parameterizing the SAM tolerance:
 - The possible velocity increase after SS1 or SS2 is triggered results from the effective acceleration a and the duration of the acceleration phase.
 - The duration of the acceleration phase is equal to a monitoring cycle ($MC = 4 \text{ ms}$)
- The following applies for calculation of the SAM tolerance:
Actual velocity for SAM = acceleration · acceleration duration
The following setup rule is derived thereof:
 - For a linear axis:
SAM tolerance [mm/min] = $a \text{ [m/s}^2\text{]} \cdot MC \text{ [s]} \cdot 1000 \text{ [mm/m]} \cdot 60 \text{ [s/min]}$
 - For a rotary axis:
SAM tolerance [rpm] = $a \text{ [rev/s}^2\text{]} \cdot MC \text{ [s]} \cdot 60 \text{ [s/min]}$
- Recommendation
The SAM tolerance value entered should be approx. 20% higher than the calculated value.
- You set the tolerance such that the "overshoot" is tolerated that necessarily occurs when standstill is reached after braking along the OFF3 ramp. However, the size of this cannot be calculated.

Responses to braking ramp violations

- Safety alarm A01706 (SI Motion: SAM/SBR limit exceeded)
- Stopping the drive with STO

4.2.12 Safe Brake Ramp (SBR)

The Safe Brake Ramp (SBR) function provides a safe method for monitoring the brake ramp. Safe Brake Ramp is applied for monitoring of braking for functions SS1 and SS2 (selected directly or as a response to a limit value violation).

The drive brakes the motor immediately with the OFF3 ramp as soon as SS1 or SS2 is triggered. Monitoring of the braking ramp is activated once the SBR delay time (p9582) has elapsed. The drive monitors the motor to ensure that it does not exceed the set braking ramp (SBR) when braking. The drive deactivates safe monitoring of the braking ramp for the various functions used as follows:

- For SS1
 - As soon as the speed drops below the STO shutdown speed (p9560).
or
 - As soon as the SS1 delay time (p9556) has elapsed.

For SS2

- As soon as the SS2 delay time (p9552) has elapsed.

Following deactivation of the SBR monitoring, depending on the function used, the drive activates the specific subsequent function:

Function used	Subsequent function
SS1	STO
SS2	SOS

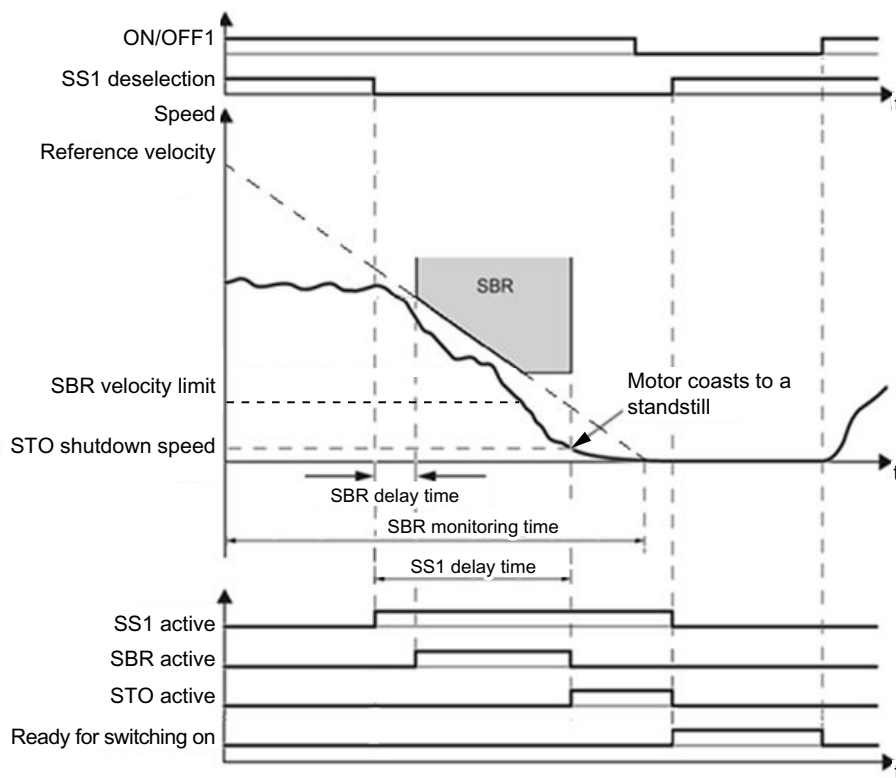

Figure 4-2 Example: SS1 with SBR

Limitation of the SBR delay time

The SBR delay time (p9582) has a minimum value of 10 ms or twice the value of the safety monitoring cycle time. SBR becomes active upon SS1 selection after the SBR delay time (p9582).

It should be noted that the specified SBR delay time is rounded to an integer multiple of the safety monitoring cycle of 4 ms.

Note

If the ramp-down time OFF3 (p1135) in your application is less than 10 seconds, then leave the SBR delay time (p9582) at its factory setting (250 ms). If SS1 goes into a fault condition during the function test, increase this value until the motor brakes normally without a fault. If the ramp-down time OFF3 (p1135) is set to several minutes, you must extend the delay time to several seconds in order to avoid any unwanted faults when selecting SS1.

Setting the SBR ramp

Align the SBR curve to the OFF3 curve. Also check that for every load condition the drive can follow this OFF3 ramp. If you want a monitoring curve that is parallel to the down ramp of the load, then you must set the following:

- Set the reference velocity (p9581) (reference speed) to the value of the maximum speed.
- SBR monitoring time (p9583) = OFF3 ramp-down time (p1135)/gear ratio
- Where: Gear ratio = Load revolutions / motor revolutions.
- Example: Gear ratio = 1/3 \Rightarrow SBR monitoring time = OFF3 ramp-down time (p1135) \cdot 3

An SBR monitoring time shorter than the value calculated above does not make sense, as the drive in this case can reduce its monitoring curve faster than the load can be braked.

The longer the monitoring time settings, the more tolerant the monitoring.

Responses to braking ramp violations

- Safety alarm A01706 (SI Motion: SAM/SBR limit exceeded)
- Stopping the drive with STO

4.3 Configuring safety functions

When configuring the safety functions, you specify the interfaces that activate the safety functions.

Selecting Basic Functions via F-DI

You can select or deselect the safety function via the Failsafe Digital Input (F-DI).

Whether STO or SS1 is activated when you select the safety function depends on the setting of the SS1 delay time:

- SS1 delay time = 0: STO is activated immediately
- SS1 delay time > 0: SS1 is activated; STO is activated after the SS1 delay time has expired

Controlling Basic and Extended Functions

The following safety telegrams are available for the safety functions:

- PROFIsafe telegram 30 (recommended for Safety Integrated Basic Functions)
- Telegram 901 (recommended for Safety Integrated Extended Functions)

If you enable the Safety Integrated Extended Functions SS2E (p9501.18 = 1) or "Transfer SLS limit value via PROFIsafe" (p9501.24 = 1), then it is imperative that you use PROFIsafe telegram 901. This means that if you do not enable these two functions, then you can use telegram 30 or 901 for PROFIsafe communication.

Detailed information about the telegrams and control word and status word assignments can be found in Sections Supplementary telegrams (Page 541) and Standard telegrams (Page 539).

Supplementary telegrams for the safety functions

The following supplementary telegrams are available for non-safety-relevant diagnostics of the safety functions:

- Telegram 700
- Telegram 701

For example, you use telegram 701 to perform the Safe Brake Test - or the manual test stop for Safety Integrated Extended Functions.

Detailed information about the telegrams and control word and status word assignments can be found in Sections Supplementary telegrams (Page 541) and Standard telegrams (Page 539).

4.4 Responses to safety faults and alarms

The stop responses of the Safety Integrated Functions are initiated by faults, and serve to brake a moving drive down to standstill. The type of response that occurs in the event of alarms and faults can either be permanently specified by the system or configured by the machine manufacturer – for example, if a limit value is violated or an internal fault occurs. The converter internally initiates the responses. They do not have to be selected by selecting an external source, e.g. PROFIsafe or F-DI.

In this way, you can stop the machine optimally adapted to the specific situation.

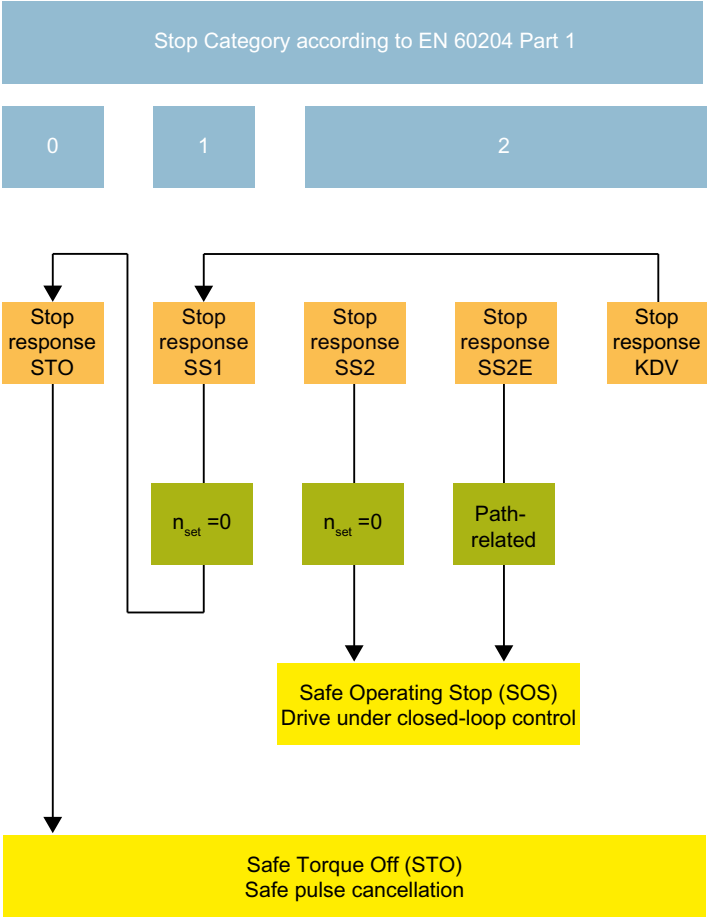

Figure 4-3 Overview of the responses

More detailed information about the various stop responses is provided in the description of the specific Safety Integrated Function.

4.4.1 Discrepancy at the inputs of the F-DI

The monitoring functions must be selected/deselected simultaneously in both monitoring channels via the input terminals and only have an effect on the associated drive.

- 1 signal: Deselecting the function
- 0 signal: Selecting the function

A time delay, for example caused by mechanical switching operations, cannot be avoided. Define a (permissible) discrepancy time so that undesirable converter responses do not occur. The selection or deselection must take place in both monitoring channels within this (permissible) discrepancy time to be interpreted as "simultaneous".

Note

Parameterization of the (permissible) discrepancy time (p9650)

To avoid that faults (nuisance faults) are incorrectly initiated, at these inputs the (permissible) discrepancy time (p9650) must always be set shorter than the shortest time between 2 switching events (ON/OFF, OFF/ON).

- If the permissible discrepancy time was exceeded (discrepancy error) then the converter outputs F01611/F30611.
Under "Response of the safety functions in detail", detailed information is provided as to precisely when STO becomes active.
- The drive indicates the discrepancy error when the RDY-LED flashes quickly red. More detailed information is provided in "Table 8-2 Status explanation of the RDY LED (Page 256)".
- The drive sets the error bit of the safety functions (= internal event).
 Communication telegrams (Page 539) and Bit assignments of the process data (Page 542)

Response of the safety functions in detail

Regarding the drive response, a distinction should be made between 2 cases:

- The initial state of both DIs is "Low" and STO is active:
 - If one of the two digital inputs is switched to "High", then the debounce time (p9651) elapses.
 - The converter does not respond if the DI returns to "Low" within the debounce time (p9651) (filtering noise pulses).
 - The (permissible) discrepancy time then elapses (p9650).
 - If there is still a discrepancy at the F-DI after the (permissible) discrepancy time elapses, then the converter issues faults F01611/F30611 (internal event).
 - The transition time "F01611 → STO" (p9658) elapses. The converter outputs faults F01600/F30600(9999) after this transition time elapses. STO remains active or becomes active again.
 - **Please note:** Even for an active internal event, i.e. after p9650 elapses, STO becomes inactive if the other DI is also switched to "High" before p9658 elapses. In this case, this means that the motor can be switched on as long as the transition time (p9658) has not yet expired.
- The initial state of both DIs is "High":
 - If one of the two digital inputs is switched to "Low", then the debounce time (p9651) elapses.
 - The converter does not respond if the DI returns to "High" within this debounce time (filtering noise pulses).
 - The following response chain subsequently occurs:
 - (a) The converter immediately initiates SS1 (for "SI SS1 delay time" (p9652) ≠ 0) or STO (for "SI SS1 delay time" = 0); regardless of when the other DI is switched.
 - (b) If "SI SS1 delay time" ≠ 0 is parameterized, then the converter starts the transition time SS1 → STO.
 - (c) The (permissible) discrepancy time (p9650) elapses. If there is still a discrepancy at the F-DI after the (permissible) discrepancy time (p9650) elapses, then the converter issues faults F01611/F30611 (internal event).
 - After the (permissible) discrepancy time (p9650) elapses, the "transition time F01611 to STO" (p9658) elapses. The converter then initiates faults F01600/F30600(9999). For "SI SS1 delay time" (p9652) ≠ 0, STO is initiated as follows (depending on which occurs first):
 - After the "SI SS1 delay time" expires
 - Or
 - After "(permissible) discrepancy time" + "transition time F01611 to STO" expires (p9650 + p9658).
 - **Please note:** For active discrepancy errors F01611/F30311 (internal event), the motor can still be operated as long as STO is not yet active.

4.4.2 Acknowledging alarms and/or faults and switching on the motor again

Acknowledging a fault

To acknowledge faults and to switch on the motor again, proceed as follows:

1. Rectify the cause of this fault.
2. Acknowledge the fault:
 - Basic Functions - Safety faults
Safety faults associated with Basic Functions require a safety-related acknowledgment followed by a standard acknowledgment.
 - Extended Functions - Safety alarms
Safety alarms associated with Extended Functions become active after a limit value is exceeded or other internal events. After the cause has been removed, these alarms require safety-related acknowledgment.
 - Extended Functions - Safety faults
Stop responses initiated by internal events are indicated using Safety faults, which after safety-related acknowledgment, require a standard acknowledgment.
3. You have the following options:
 - **POWER ON** By switching off the supply voltage and switching it on again
 - **Selecting/deselecting STO** - By selecting/deselecting F-DI
or
 - Using the PROFIsafe telegram

Note that you can only acknowledge Safety alarms, such as A01711 and other internal events caused by limit values being exceeded for Extended Safety, in a safety-related way using STO if p9507.0 = 1 is set. (extended message acknowledgment to default value).
 - **Safe acknowledgment** Using PROFIsafe telegram (S_STWx byte 0 bit 7)

Switching the motor on again

- Acknowledge the drive faults.
- Switch the motor off and then on again. (Bit 0 in the STW1: 0 → 1)
-
- Safety alarms, such as A01711 and other internal events caused by limit values being exceeded for Extended Safety, can only be acknowledged in a safety-related way using STO if p9507.0 = 1 is set. (extended message acknowledgment to default value).

See also

Communication telegrams (Page 539)

Bit assignments of the process data (Page 542)

4.5 Response times

The Safety Integrated Functions are executed with a safety monitoring cycle of 4 ms.

PROFIsafe telegrams are evaluated in the PROFIsafe scan cycle. The PROFIsafe scan cycle corresponds to twice the monitoring cycle.

Note for understanding the following tables

The drive system is the component that provides the safety functions. The designation "fault-free drive system" means that the component that provides the safety functions does not have a defect itself:

- Worst case for a fault-free drive system
For faults outside the drive system, the "Worst case for a fault-free drive system" reaction time is guaranteed.
Faults outside the drive system are, for example, faulty setpoint specification by the control system, limit value violations as a result of the behavior of the motor, closed-loop control, load, etc.
- Worst case when a fault exists
For a single fault within the drive system, the "Worst case when a fault exists" reaction time is guaranteed.
Faults within the drive system are, for example, a defect in a switch-off signal path of the power unit, a defect in an encoder actual value measurement, a defect in a microprocessor, etc.

4.5.1 Reaction times of Safety Integrated Basic Functions

4.5.1.1 Control of the Safety Integrated Basic Functions via terminals

The following table lists the response times from the control via terminals until the response actually occurs.

Table 4-1 Response times when controlling via terminals

Function	Worst case for	
	Drive system has no fault	A fault is present
STO	8 ms + $t_E^{1)}$	12 ms + $t_E^{1)}$
SBC	16 ms + $t_E^{1)}$	32 ms + $t_E^{1)}$
SS1/SS1E (time-controlled) Selection until STO is initiated	8 ms + $p9652^{2)}$ + $t_E^{1)}$	12 ms + $p9652^{2)}$ + $t_E^{1)}$
SS1/SS1E (time-controlled) Selection until SBC is initiated	16 ms + $p9652^{2)}$ + $t_E^{1)}$	32 ms + $p9652^{2)}$ + $t_E^{1)}$
SS1 (time-controlled) Selection until braking is initiated	12 ms + 2 ms + $t_E^{1)}$	16 ms + 2 ms + $t_E^{1)}$

¹⁾ The following applies for t_E (debounce time of the digital input being used):

4.5 Response times

p9651 ³⁾ = 0	t _E = 8 ms
p9651 ³⁾ ≠ 0	t _E = p9651 + 5 ms

²⁾ p9652: SI SS1 delay time

³⁾ p9651: SI STO/SBC/SS1 debounce time

4.5.1.2 Control of the Safety Integrated Basic Functions via PROFIsafe

The following table lists the response times¹⁾ from receiving the PROFIsafe telegram at the converter up to initiating the specific response.

Table 4-2 Response times when controlling via PROFIsafe

Function	Worst case for	
	Drive system has no fault	A fault is present
STO	20 ms + t _K ²⁾	20 ms + t _K ²⁾
SBC	24 ms + t _K ²⁾	40 ms + t _K ²⁾
SS1/SS1E (time-controlled) Selection until STO is initiated	20 ms + p9652 ³⁾ + t _K ²⁾	20 ms + p9652 ³⁾ + t _K ²⁾
SS1/SS1E (time-controlled) Selection until SBC is initiated	24 ms + p9652 ³⁾ + t _K ²⁾	40 ms + p9652 ³⁾ + t _K ²⁾
SS1 (time-controlled) Selection until braking is initiated	20 ms + 2 ms + t _K ²⁾	20 ms + 2 ms + t _K ²⁾

¹⁾ The specified response times involve SINAMICS-internal response times. Program run times in the F-host and the transmission time via PROFINET are not taken into account. When calculating the response times between the F-CPU and the drive, you must take into account that faults in the communication can result in a safety function only being selected after the PROFIsafe monitoring time (F_WD_Time) has expired. The PROFIsafe monitoring time (F_WD_Time) must also be included in the calculation when an error occurs.

²⁾ t_K is the time for internal communication within the SINAMICS module; t_K can be determined as follows:

For isochronous communication	t _K = T _o (determine T _o from the bus configuration on the control side)
For non-isochronous communication	t _K = 4 ms

³⁾ p9652: SI SS1 delay time

4.5.2 Response times of Safety Integrated Extended Functions

4.5.2.1 Controlling Safety Integrated Extended Functions via PROFIsafe

The following table lists the response times¹⁾ from receiving the PROFIsafe telegram at the converter up to initiating the specific response.

Table 4-3 Response times when controlling via PROFIsafe

Function	Worst case for	
	Drive system has no fault	A fault is present
STO	$5 \cdot t_{EF^5} + t_{BF^6} + t_{K^4}$	$5 \cdot t_{EF^5} + 2 \cdot t_{BF^6} + t_{K^4}$
SBC	$5 \cdot t_{EF^5} + 2 \cdot t_{BF^6} + t_{K^4}$	$5 \cdot t_{EF^5} + 6 \cdot t_{BF^6} + t_{K^4}$
SS1 (time controlled), SS1E, SS2E: Time from selecting up to starting the safe timer SS1 (acceleration controlled), SS2: Time from selecting up to initiating braking SOS: Time from selecting up to starting standstill monitoring	$5 \cdot t_{EF^5} + 2 \text{ ms} + t_{K^4}$	$5 \cdot t_{EF^5} + 2 \text{ ms} + t_{K^4}$
SBR or SAM (limit value violation until STO active)	$2 \cdot t_{EF^5} + t_{BF^6}$	$2.5 \cdot t_{EF^5} + t_{BF^6} + 1 \text{ ms}$
SOS standstill tolerance window violated	$1.5 \cdot t_{EF^5} + 2 \text{ ms}$	$3 \cdot t_{EF^5} + 2 \text{ ms} + 1 \text{ ms}$
SLS speed limit violated ²⁾	$2 \cdot t_{EF^5} + 2 \text{ ms}$	$3.5 \cdot t_{EF^5} + 2 \text{ ms} + 1 \text{ ms}$
SSM ³⁾	$4 \cdot t_{EF^5}$	$4.5 \cdot t_{EF^5} + 1 \text{ ms}$
SDI (limit value violation until braking is initiated)	$1.5 \cdot t_{EF^5} + 2 \text{ ms}$	$3 \cdot t_{EF^5} + 2 \text{ ms} + 1 \text{ ms}$
SLA: Selection or deselection	$5 \cdot t_{EF^5} + t_{K^4}$	$5 \cdot t_{EF^5} + t_{K^4}$
SLA: Limit value violation	$3 \cdot t_{EF^5} + 2 \text{ ms}$	$4 \cdot t_{EF^5} + 2 \text{ ms} + 1 \text{ ms}$

- 1) The specified response times involve internal SINAMICS response times. Program run times in the F-host and the transmission time via PROFINET are not taken into account. When calculating the response times between the F-CPU and the drive, you must take into account that faults in the communication can result in a safety function only being selected after the PROFIsafe monitoring time (F_WD_Time) has expired. The PROFIsafe monitoring time (F_WD_Time) must also be included in the calculation when an error occurs.
- 2) SLS: Specification of the response time required to initiate a braking response in the drive - or for the output of the "SOS selected" message to the motion control system.
- 3) SSM: The data corresponds to the times between the limit value being undershot up to sending the information via PROFIsafe.
- 4) t_K is the time for internal communication within the SINAMICS module; t_K can be determined as follows:

For isochronous communication	$t_K = T_o$ (determine T_o from the bus configuration on the control side)
For non-isochronous communication	$t_K = 4 \text{ ms}$

- 5) Safety monitoring cycle Extended Functions $t_{EF} = 4 \text{ ms}$
- 6) Safety monitoring cycle Basic Functions $t_{BF} = 4 \text{ ms}$

4.6 Acceptance - completion of commissioning

What is an acceptance?

The machine manufacturer is responsible in ensuring that the plant or machine functions perfectly. As a consequence, after commissioning, the machine manufacturer must check those functions or have them checked by specialist personnel, which represent an increased risk of injury or material damage. This acceptance or validation is, for example, also specified in the European machinery directive and essentially comprises two parts:

- **Acceptance test:** Checking the safety-relevant functions and machine parts after startup.
- **Documentation:** Generate an "Acceptance report" that describes the test results.

Supply information for the validation, e.g. the harmonized European standards EN ISO 13849-1 and EN ISO 13849-2.

Acceptance test of the machine or plant

The acceptance test is used to check whether the safety-relevant functions in the machine or system function properly. The documentation of the components used in the safety functions can also provide information about the necessary tests. Testing the safety-relevant functions includes, e.g. the following:

- Are all safety equipment such as protective door monitoring devices, light barriers or emergency-off switches connected and ready for operation?
- Does the higher-level control respond as expected to the safety-relevant feedback signals of the drive?
- Do the drive settings match the configured safety-relevant function in the machine?

Acceptance test of the drive

The acceptance test of the drive is a part of the acceptance test of the entire machine or plant.

The acceptance test of the drive checks whether the settings of the Safety Integrated Functions are compatible with the configured safety functions of the machine. The acceptance test documents the settings with which the real function fulfills the intended functionality.

Documentation

The following must be documented for the drive:

- Result of the acceptance tests
- Settings of the integrated drive safety functions

This documentation must be countersigned.

Persons authorized for acceptance

Personnel from the machine manufacturer, who, on account of their technical qualifications and knowledge of the safety functions, are in a position to perform the acceptance test in the correct manner are authorized to perform the acceptance testing of the drive.

Recommendations

For the acceptance test, check whether the safety functions in the drive have been set correctly.

- Perform the acceptance test with the maximum possible velocity and acceleration to test the expected maximum braking distances and braking times.
- Alarm A01697 (Test stop for motion monitoring is required):
This alarm is issued following each system startup and is not critical for acceptance.

After the acceptance test of the drive's safety functions, you must also check whether the safety-related functions in the machine or system are functioning correctly.

Note

Examples of acceptance tests

The following acceptance tests are examples which demonstrate the basic procedure. They are not suitable for every possible setting of the drive.

When do you have to conduct an acceptance test of the machine or plant?

You must conduct an acceptance test of the machine or plant in the following cases:

- After commissioning
- After importing a new firmware version to the drive
- If you changed the parameter assignment of the drive
- After the maximum time between 2 acceptance tests set using p9659 has expired (forced checking procedures).

When do you have to conduct an acceptance test of the drive?

If you replaced the drive, you have to conduct an acceptance test for it.

Note

When you replace the drive, an error message appears. Acknowledge this error message, e.g. by switching off and on.

What does the acceptance test for the drive consist of?

Documentation

1. Supplement/change the hardware data
2. Supplement/change the software data (specify version)

Function test, safety functions

You must perform an acceptance test individually for each function used and each configured control.

As far as possible, the acceptance tests are to be carried out at the maximum possible machine speed and acceleration rates to determine the maximum braking distances and braking times that can be expected.

If Basic Functions and Extended Functions are combined, the acceptance test for both types must be carried out for the functions used.

Functional testing of forced checking procedure (test stop)

Select and deselect STO. More detailed information on the topic of "Forced checking procedure (test stop)" is provided in Chapter "Test stop (forced checking procedure) (Page 223)".

4.6.1 Acceptance tests – Basic Functions

4.6.1.1 STO acceptance test

Precondition

The drive is ready.

- The drive signals neither faults nor alarms of the safety functions (r0945[0...7], r2122[0...7]).
- STO is not active (r9734.0 = 0).

Procedure

Use the following procedure for the acceptance test of the Basic Function STO:

Switch on motor

1. Enter a speed setpoint $\neq 0$.
2. Switch on the motor (ON command).
3. Check that the motor rotates as required.

Select STO

1. Select STO while the motor is running.
Test each configured activation, e.g. via digital inputs and PROFIsafe.
2. Check the following:
 - If a mechanical brake is not available, the motor coasts to a standstill.
A mechanical brake brakes the motor and holds it to ensure that it remains at a standstill.
 - The drive signals neither faults nor alarms of the safety functions (r0945[0...7], r2122[0...7]).
 - The drive signals the following:
"STO is active" (r9734.0 = 1).

Deselect STO

1. Deselect STO.
2. Check the following:
 - STO is not active (r9734.0 = 0).
 - The drive signals neither faults nor alarms of the safety functions (r0945[0...7], r2122[0...7]).
 - Check that the motor rotates as required.

4.6.1.2 Acceptance test SS1

Precondition

The drive is ready.

- The drive signals neither faults nor alarms of the safety functions (r0945[0...7], r2122[0...7]).
- SS1 is not active (r9734.1 = 0).

Procedure

To perform the acceptance test of the SS1 Basic Function, proceed as follows:

Switch on motor

1. Enter a speed setpoint $\neq 0$.
2. Switch on the motor (ON command).
3. Check that the motor rotates as required.

Select SS1

1. Select SS1 while the motor is switched on.
Test each configured activation, e.g. via digital inputs and PROFIsafe.
2. In your machine, check the following:
 - The motor brakes on the OFF3 ramp.
 - SS1 is active (r9734.1 = 1).
 - STO becomes active after the time p9652 elapses and the drive then signals: "STO is active" (r9734.0 = 1).

Deselect SS1

1. Deselect SS1.
2. Check the following:
 - SS1 is not active (r9734.1 = 0).
 - The drive signals neither faults nor alarms of the safety functions (r0945[0...7], r2122[0...7]).
 - Check that the motor rotates as required.

4.6.1.3 SBC acceptance test

Precondition

The drive is ready.

- The drive signals neither faults nor alarms of the safety functions (r0945[0...7], r2122[0...7]).
- SBC is not active (r9734.0 = 0 **and** r0899.12 = 1).

Procedure

Use the following procedure for the acceptance test of the Basic Function SBC:

Switch on motor

1. Enter a speed setpoint $\neq 0$.
2. Switch on the motor (ON command).
3. Check that the motor is running.
4. Enter the speed setpoint = 0.

Select SBC

1. Select the STO function or the SS1 function.
2. Check the following: The drive signals the following: "SBC is active" (r9734.0 = 1 **and** r0899.12 = 0).

Deselect STO

1. Deselect STO.
2. Check the following:
 - The drive signals the following: "SBC is not active" (r9734.0 = 0 **and** r0899.12 = 1).
 - The drive signals neither faults nor alarms of the safety functions (r0945[0...7], r2122[0...7]).

4.6.2 Acceptance tests Extended Functions

As with the Basic Functions, you must perform an acceptance test for each Extended Function and each control type that you use.

As of version 15.1 of the commissioning tool Startdrive, a wizard is available for this purpose to guide you step by step through the acceptance process.

4.7 Information pertaining to component replacements

Replacing a component from the perspective of Safety Integrated

Note

Note additional safety instructions

Observe the instructions with regard to changing or replacing software components in Section "Safety instructions (Page 15)"!

The faulty component was replaced according to safety regulations. The information relevant from the perspective of Safety Integrated is provided in the following.

- Based on the NodeID and the saved CRC of the particular hardware component, the drive identifies that a component has been replaced. You can take the responses of the drive and the actions that have to be carried out from the following table:

	Replaced component	Control type	Drive response (fault)	User action			Diagnostic parameters
				Fault acknowledgment required ¹⁾	Acknowledgment is required that the component has been replaced ²⁾	Save ³⁾	
Basic Functions	Motor	All	F01641.1 = 1	Yes	No	Yes	r9776.2 = 1
Extended Functions	Motor	All	F01640.3 = 1 F01640.4 = 1 F01641.1 = 1 F01641.5 = 1 F01641.6 = 1	Yes	Yes	Yes	r9776.2 = 1 r9776.3 = 1

- The fault must be acknowledged each time a component is replaced using a standard acknowledgment. However, even without acknowledgment the drive can still be operated.
- To acknowledge that the component has been replaced, set parameter p9702 = 29. p9702 jumps back up to a value of 0 once the acknowledgment process has been completed.
- You must save the modified data after a component has been replaced:
 - It is not permissible that the firmware update is active on the drive object.
 - Copy from RAM to ROM by setting p0977 = 1.
 If the modified data is not saved, then the drive re-issues the fault at the next power on.

Acceptance test and acceptance report



WARNING

Unwanted motion if components are replaced without a function test

After a component replacement, connections or functions can be defective so that death or serious injury can result if a person enters the danger zone of the motors.

- After component replacement, always run a simplified function test.

After the machine has been modified, a full verification is required again – including the acceptance test and appropriate documentation. The drive identifies when a component has been replaced based on the saved checksums (CRC):

- Message F01640/F01641 identifies as to which component was replaced.
- Message F01650 indicates as to whether an acceptance test is required, and the test depth that should be performed.
- Each time a component is replaced, a function test should always be carried out so that incorrect connections and/or wiring can be ruled out.
- For SINAMICS drives, after a component has been replaced, generally a reduced/partial acceptance test is sufficient.

Replacing a converter

When replacing a converter, after it has run-up, fault F01641 is displayed as a result of the changed checksums. No additional fault response is initiated, and operation of the drive is not restricted as a result.

- The message can be deleted with a standard acknowledgment.
- Copying from RAM to ROM should be carried out to avoid that the message is output again after the next power on.
- A reduced acceptance test of the safety functions is required.
 - Check the Emergency Stop function (STO or SS1), as well as the SBC function assuming that it is being used.
 - Test the forced checking procedure (test stop) of the safety function on the drive
 - After replacing a component, check the actual value sensing by switching on the drive and briefly operating in both directions of rotation.
 - The converter data (hardware/software version) should be added to the acceptance protocol, the changed checksum and time stamp should be documented and countersigned.

Replacing the motor

When replacing the motor, after it has run-up, fault F01640 (channel 2) and F01641 (channel 1) is displayed as a result of the changed checksums. Further, a fault response is initiated, which prevents the drive from being operated.

- The component replacement must be acknowledged: p9702 = 1D hex; then save by copying from RAM to ROM
- A reduced acceptance test is required.
 - After replacing a component, check the actual value sensing by switching on the drive and briefly operating in both directions of rotation.
 - Only for Extended/Advanced Functions: Check the safety-related actual value sensing: With the motion monitoring functions activated (e.g. SLS or SSM with hysteresis), briefly operate the drive in both directions.
 - Only for Extended/Advanced Functions and only after the encoder has been replaced: Test the encoder parameterization (a trace recording is not required)
- The converter data (hardware/software version) should be added to the acceptance protocol, the changed checksum and time stamp should be documented and countersigned.

4.8 Functional safety

Safety, from the perspective of the object to be protected, cannot be split-up. The causes of hazards and, in turn, the technical measures to avoid them can vary significantly. This is why a differentiation is made between different types of safety (e.g. by specifying the cause of possible hazards). "Functional safety" is involved if safety depends on the correct function.

To ensure the functional safety of a machine or plant, the safety-related parts of the protection and control devices must function correctly. In addition, the systems must behave in such a way that either the plant remains in a safe state or it is brought into a safe state if a fault occurs. In this case, it is necessary to use specially qualified technology that fulfills the requirements described in the associated Standards. The requirements to implement functional safety are based on the following basic goals:

- Avoiding systematic faults
- Controlling random faults or failures

Benchmarks for establishing whether or not a sufficient level of functional safety has been achieved include the probability of hazardous failures, the fault tolerance, and the quality that is to be ensured by avoiding systematic faults. This is expressed in the standards using specific classification. In IEC/EN 61508, IEC/EN 62061 "Safety Integrity Level" (SIL) and EN ISO 13849-1 "Category" and "Performance Level" (PL).

4.9 Machinery Directive

The basic safety and health requirements specified in Annex I of the Directive must be fulfilled for the safety of machines.

The protective goals must be implemented responsibly to ensure compliance with the Directive.

Manufacturers of a machine must verify that their machine complies with the basic requirements. This verification is facilitated by means of harmonized standards.

IEC 61800-5-2 Adjustable-speed electrical power drive systems Part 5-2 is relevant for the Machinery Directive: Safety requirements - Functional safety

Within the context of IEC 61508, IEC 61800-5-2 considers adjustable speed electric power drive systems (PDS), which are suitable for use in safety-related applications (PDS(SR)).

IEC 61800-5-2 places demands on PDS(SR) as subsystems of a safety-related system. This therefore permits the implementation of the electrical/electronic/programmable electronic elements of a PDS(SR) taking into account the safety-relevant performance of the safety function(s) of a PDS.

Manufacturers and suppliers of PDS(SR) can prove to users (e.g. integrators of control systems, developers of machines and plants etc.) the safety-relevant performance of their equipment by implementing the specifications stipulated in standard IEC 61800-5-2.

Installing

5.1 Safety instructions



NOTICE

Thermal damage to temperature-sensitive parts

Some parts of the electrical motor enclosure can reach temperatures that exceed 100 °C. If temperature-sensitive parts, for instance electric cables or electronic components, come into contact with hot surfaces then these parts can be damaged.

- Ensure that no temperature-sensitive parts come into contact with hot surfaces.

5.2 Installing the motor

5.2.1 Checklists prior to assembly

Note

Required checks

The checks listed below are a minimum benchmark and must be performed in any case. Further checks before, during and after the installation of the motor depend on the system-specific conditions and are the responsibility of the plant or system manufacturer.

- Thoroughly familiarize yourself with the safety instructions and observe the checklists below before starting any work.

Table 5-1 Checklist

Check	OK
General checks	
Are the environmental conditions in the permissible range?  Chapter Permissible environmental conditions for the motor (Page 280).	
Checks regarding the mechanical system	
Is the motor free of visible damage?	
Have the mounting surfaces (e.g. flange, shaft) on the customer machine and on the motor been cleaned?	
Are the mounting surfaces free of corrosion?	
Do the mounting dimensions (e.g. shaft diameter, shaft length, true run) on the customer machine meet the specification?	

5.2.2 Mounting instructions for the motor

NOTICE
Damage to shaft sealing rings caused by solvent
If shaft sealing rings come into contact with solvents when removing the corrosion protection, the shaft sealing rings can be damaged.
<ul style="list-style-type: none"> • Avoid contact between solvents and shaft sealing rings.

NOTICE
Damage to the motor due to runout on the shaft extension
Blows and pressure applied to the motor shaft extension can damage the motor.
<ul style="list-style-type: none"> • Mount the motor without runout and thrust on the shaft extension.

- Observe the specifications on the rating plate.
- Observe the warning and information plates on the motor.
- Remove the anti-corrosion protection thoroughly from the motor shaft. Use commercially available solvents.
- Please pay attention to the notes on the thermal mounting variants.
- If the motor is installed vertically with the shaft extension facing up, ensure that no liquid can enter the upper bearing.
- Ensure that the flange is in even contact with the mounting surface.
- Use hexagon socket head cap screws with a property class of at least 8.8.
- When tightening the fastening bolts avoid any uneven stressing.
- Observe the tightening torques for the fastening bolts.

Tightening torques for fastening bolts

The general tolerance for the tightening torque is 10%. The tightening torque is based on a friction coefficient of $\mu = 0.14$.

Motor	Bolt DIN 7984	Washer ISO 7092 in mm	Tightening torque for bolts (not for electrical connections)
1FK2□02	M4	4 (d2 = 8)	2.2 Nm
1FK2□03	M5	5 (d2 = 9)	4 Nm
1FK2□04 1FK2105	M6	6 (d2 = 11)	8 Nm
1FK2205 1FK2□06	M8	8 (d2 = 15)	20 Nm
1FK2□08	M10	10 (d2 = 18)	35 Nm
1FK2□10	M12	12 (d2 = 20)	60 Nm

5.2.3 Attaching the output elements

Reduce the bending torque load applied to the shaft and the bearing by appropriately arranging the output elements.

Mount the output elements as close as possible to the motor bearing.

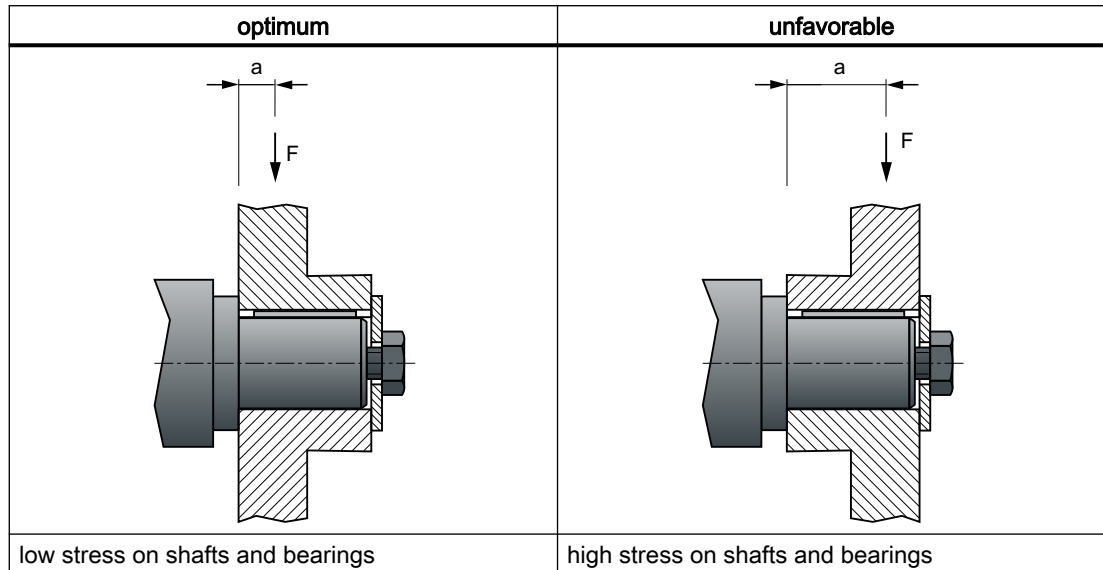

Mount or remove the power output elements (e.g. couplings, gear wheels, belt pulleys) using suitable devices only (see figure).

- Use the threaded hole in the shaft extension.
- If required, heat up the output elements before mounting or removing.
- When removing the output elements, use an intermediate disk to protect the centering in the shaft extension.

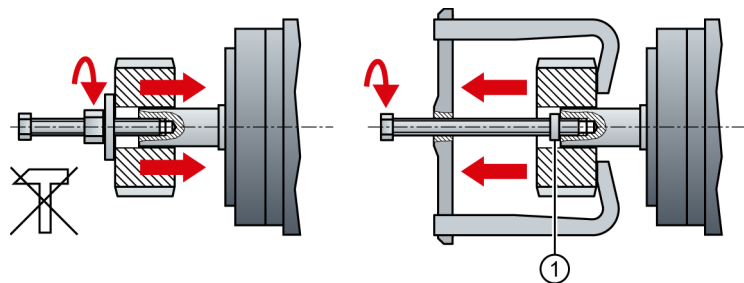

1 Intermediate washer/disk (to protect the centering in the shaft extension)

Figure 5-1 Mounting and removing output elements

- If necessary, completely balance the motor together with the output elements according to ISO 1940.

Note

Motors with feather key are half-key balanced. The motors have been balanced with half a feather key.

The motor dimensions can be found in Chapter:



"Dimension drawings (Page 321)"

5.3 Installing the converter

5.3.1 Installation conditions

When installing the converter carefully observe the conditions listed below in order to guarantee reliable, continuous and trouble-free operation.

- The converter is designed for installation in a control cabinet.
- The converter is certified for use in environments with degree of pollution 2 without condensation; i.e. in environments where no conductive pollution/dirt occurs. Condensation is not permissible.
- The converter fulfills degree of protection IP20 according to IEC 60529.
- EMC-compliant installation:
 EMC-compliant installation of a machine or system (Page 47).

Additional requirements for plants and systems in the United States / Canada (UL/cUL)

A label with the following number is provided with the device: A5E36790112.

Note the instructions on the label and attach the label in a clearly visible location close to the converter in the control cabinet.

Installation notes

- Install the converter vertically with the flap for the LED display facing upwards.

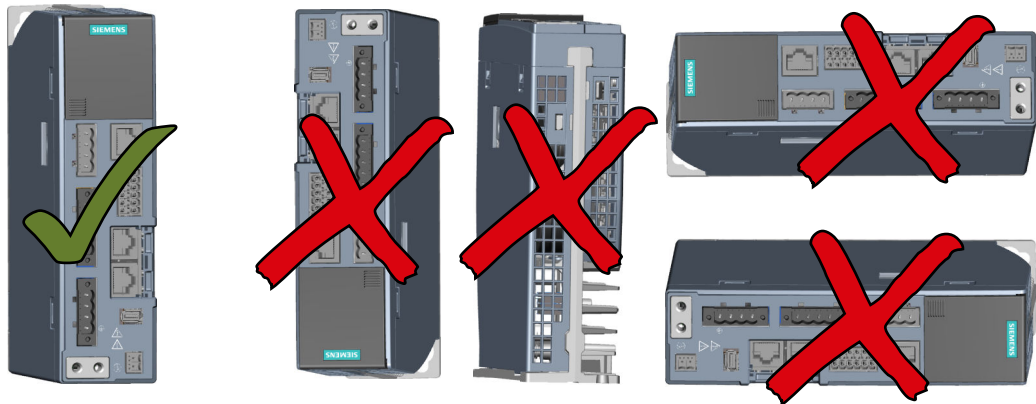

Figure 5-2 Mounting position of the converter

- Maintain the minimum clearances to other components.
- Use the recommended fastening elements and comply with the specified torques.

Clearances to cabinet panels and other components

Leave a minimum 100 mm clearance to other devices at the top and bottom. A lateral clearance between multiple SINAMICS S210 converters is not mandatory. Observe a lateral clearance of at least 10 mm to other devices.

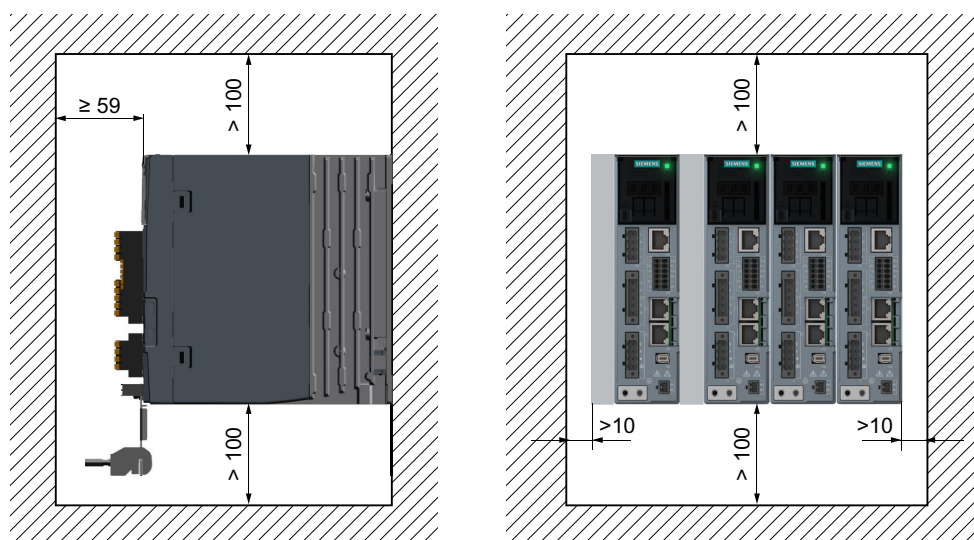

Figure 5-3 Clearances to cabinet panels and other components for converters with 1 AC line connection

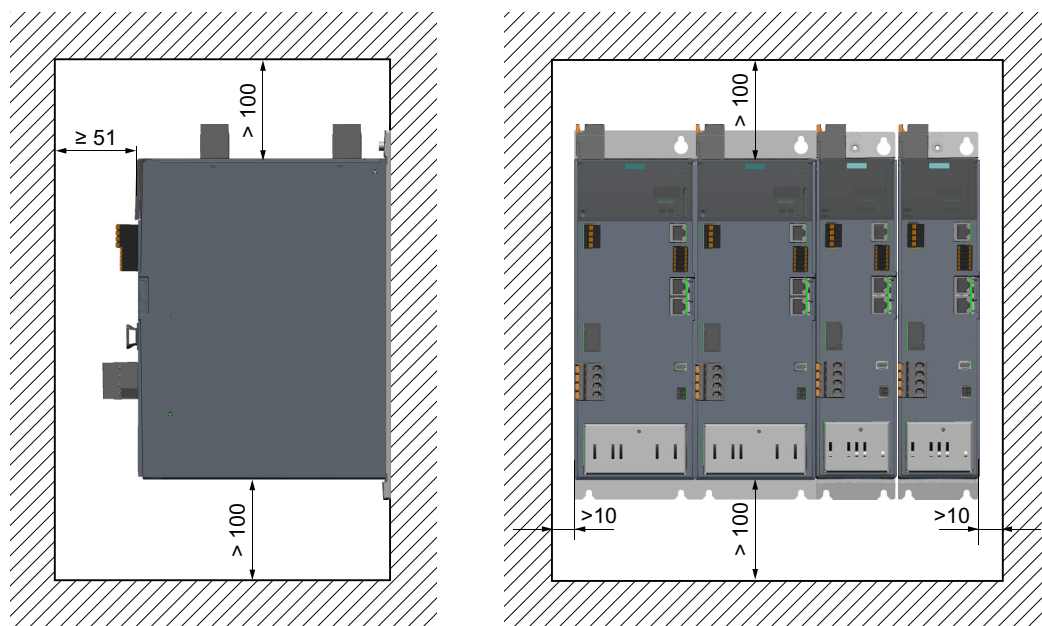

Figure 5-4 Clearances to cabinet panels and other components for converters with 3 AC line connection

5.3.2 Dimensions and drilling dimensions

Dimension drawings and drilling dimensions for converters with 1 AC line connection

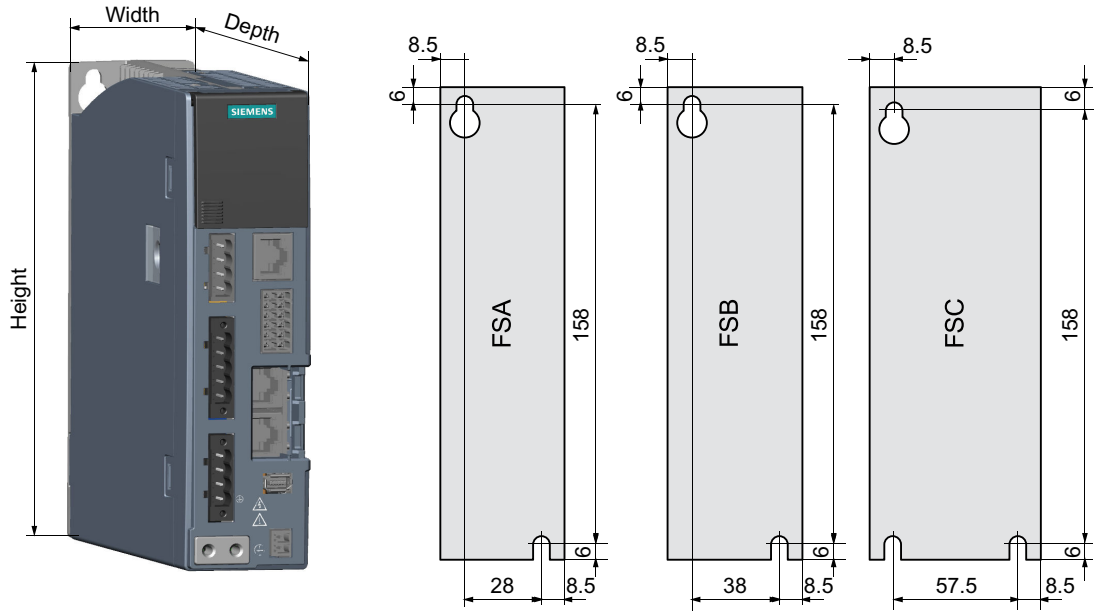

Figure 5-5 Dimension drawing and drilling dimensions

Table 5-2 Dimensions and mounting

Frame size	Width	Height	Depth	Weight	Mounting
FSA	45 mm	170 mm	170 mm	1.1 kg	2 x M5 / 4 Nm
FSB	55 mm	170 mm	170 mm	1.2 kg	2 x M5 / 4 Nm
FSC	74.5 mm	170 mm	197.4 mm	1.9 kg	3 x M5 / 4 Nm

Dimension drawings and drilling dimensions for converters with 3 AC line connection

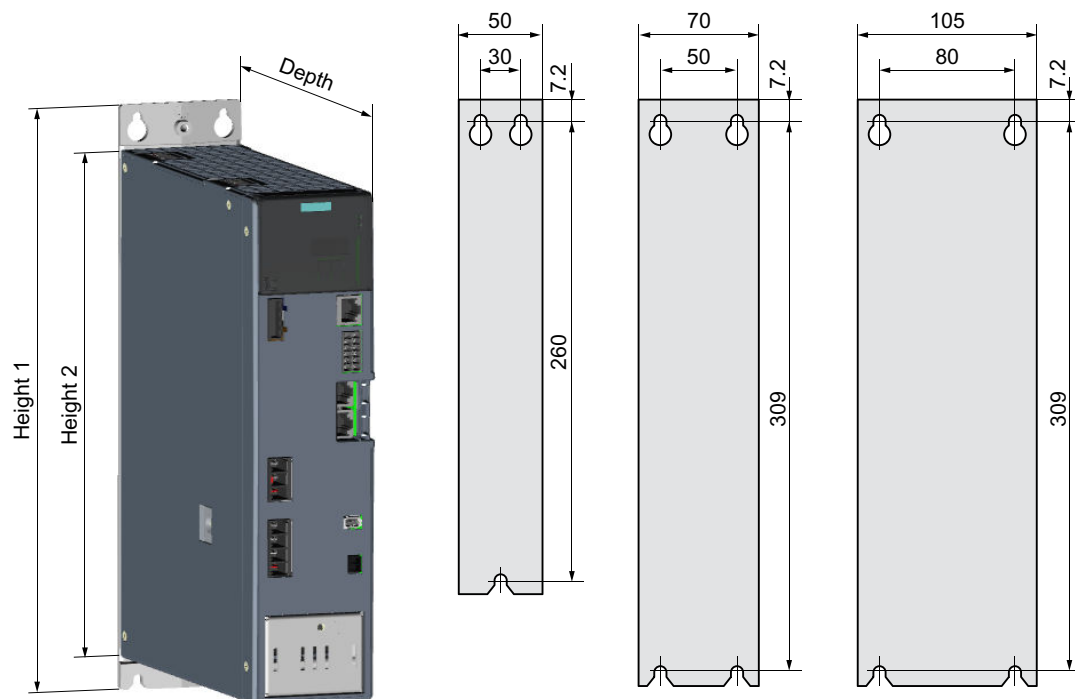

Figure 5-6 Dimension drawing and drilling dimensions

Table 5-3 Dimensions and mounting

Frame size	Width	Height 1	Height 2	Depth	Weight	Mounting
FSA	50 mm	272.9 mm	231 mm	223.3 mm	2.1 kg	3 x M5 / 4 Nm
FSB	70 mm	322 mm	280 mm	223.3 mm	3.2 kg	4 x M5 / 4 Nm
FSC	105 mm	322 mm	280 mm	223.3 mm		4 x M5 / 4 Nm

5.4 Connecting the converter and the motor

5.4.1 Cable lengths

Cable lengths for connecting the motor to the converter

The motor is connected to the converter using a one cable system (OCC - one cable connection) via the MOTION-CONNECT cable. The MOTION-CONNECT cable includes the power connections for the motor, the encoder connection and the connections for the motor holding brake.

Ordering information for MOTION-CONNECT cables is provided in the following Section:

 Connection cables between the motor and the converter (Page 336)

Ordering information for external line filters is provided in the following Section:

 External line filter (Page 341)

Additional information about electromagnetic compatibility is provided at:

 Electromagnetic compatibility according to EN61800-3 (Page 310)

Table 5-4 Converters with 1 AC line connection

	Converters with internal line filter	Converters with additional external filter
EMC category C2	10 m	25 m
EMC category C3	25 m	50 m

Table 5-5 Converters with 3 AC line connection

	Converters with internal line filter	Converters with additional external filter ¹⁾
Without DC link coupling		
EMC category C2	---	25 m
EMC category C3	25 m	50 m
with DC link coupling ≤ 6 converters ²⁾		
EMC category C2	---	100 m
EMC category C3	100 m	250 m

¹⁾ The filters are scheduled for supply in the 4th quarter of 2019.

²⁾ The data is applicable for the complete cable length of the motors, whose associated converters are coupled with one another through the DC link. The maximum cable length for a motor is 50 m.

Cable lengths for additional converter connections

Type of connection	Connection via	Permissible cable length
Control voltage 24 VDC	X124	30 m
External braking resistor for converters with 1 AC line connection	X1 (R1, DCP)	3 m
External braking resistor for converters with 3 AC line connection	X4 (R1, DCP)	10 m
Service interface	X127	10 m
Digital inputs	X130	30 m
Connection to the control system via PROFINET	X150 P1 X150 P2	100 m

5.4.2 Connecting a MOTION-CONNECT cable at the motor

NOTICE
Destruction of the motor if it is directly connected to the three-phase line supply
The motor will be destroyed if it is directly connected to the three-phase line supply.
<ul style="list-style-type: none"> Only operate motors with the permitted converters.

The manufacturer of the system/machine is responsible for ensuring that installation is performed correctly.

Ensure that the associated warning labels in the appropriate national language are attached.

The motors have SPEED-CONNECT M12, M17 or M23 connectors that can be rotated.

You connect the motor to the converter using a MOTION-CONNECT OCC cable. The cables for the power, the holding brake, the encoder and the shielding are integrated in the OCC cable.

- Use the prefabricated MOTION-CONNECT OCC cables from SIEMENS. This reduces the installation time and costs, and increases the operational reliability of the drive.

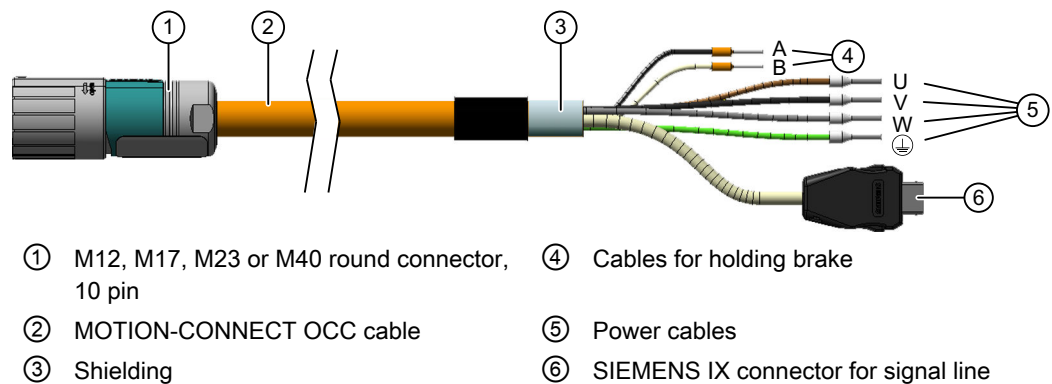

Figure 5-7 MOTION-CONNECT OCC (sample image)

- Check that the sealing surfaces of the connectors have not been damaged.

Clearance required when connecting the motor

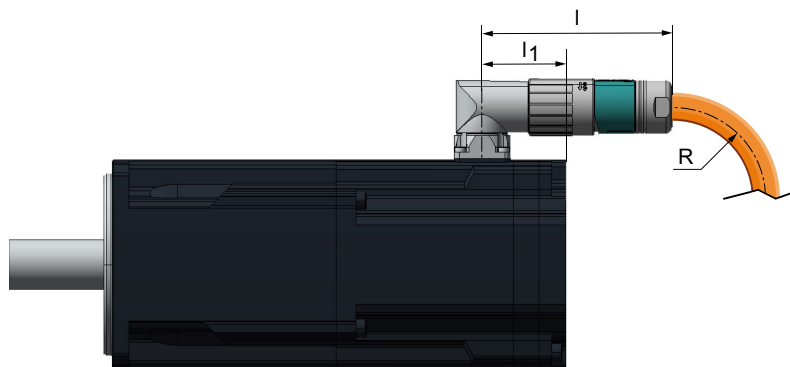

Figure 5-8 Sample image

Motor	Connector size	Distance, point of rotation to NDE		Length of the plug connection	Minimum bending radius, static	
		Without brake	With brake		MC500	MC800 PLUS
		l_1 / mm			R_{static} / mm	
1FK2□02	M12	33		61	23.5	28.2
1FK2□03		23				
1FK2□04	M17	26		70	25.5	30.6
1FK2205		28	34			
1FK2105		20	36			
1FK2□06	M23	41	53	99	30.7	36.9
1FK2□08		39				
1FK2□10		43				

Rotation range of the OCC connector on the motor

You can rotate the motor connector. Use a suitable socket connector as lever to rotate the connector.

Note

A maximum of 10 rotations are permitted so as not to impair the degree of protection of the motor.

Table 5-6 Rotational range of the connector

Motor	Angle α	Angle α'	Connector size	Drawing
1FK2□02 1FK2□03	261°	45°	M12	

Table 5-7 Rotational range of the connector

Motor	Angle α	Angle α'	Connector size	Drawing
1FK2□04	205°	80°	M17	
1FK2□05	255°	35°		
1FK2□06	312°	13°	M23	
1FK2□08				
1FK2□10				

The motors are equipped with SPEED-CONNECT connectors.

You can also connect quick-connection cables with SPEED-CONNECT to motor connectors as conventional cables with screw locks (fully threaded).

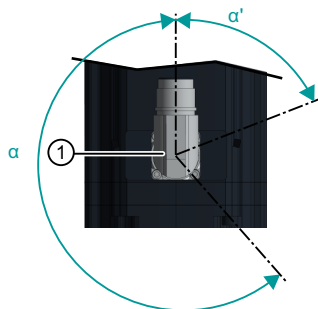
Note

We recommend cables with SPEED-CONNECT because they are easier to use.

Establishing a SPEED-CONNECT connection

Procedure

Note

- Only tighten the connector by hand.
- Do not use any wrenches or similar tools.

1. Ensure that the union nut of the SPEED-CONNECT connector is rotated to the end stop in the direction of the "open" arrow.
2. Align the SPEED-CONNECT connector so that the triangles on the top of the connectors are opposite one another.



3. Push the power connector onto the motor connecting socket as far as it will go.
4. Turn the union nut by hand in the direction of "close" through at least 45° (position A) or up to the end stop (position B)

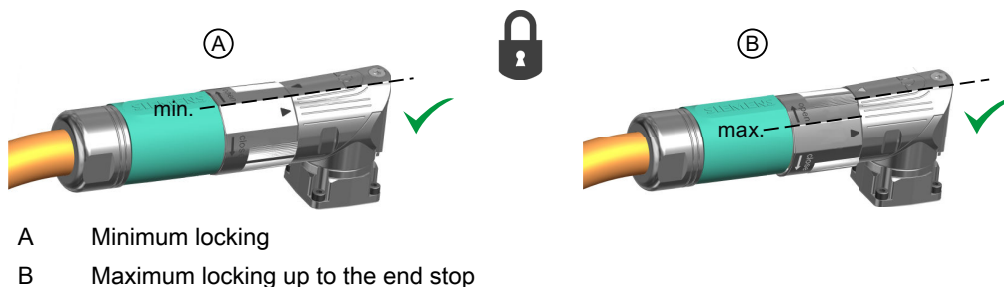

Note

A secure connection is only guaranteed from position A onward.

You have established a secure connection.



Releasing a SPEED-CONNECT connection

Procedure

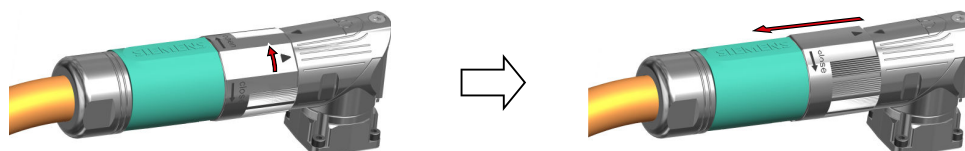

1. Turn the union nut of the SPEED-CONNECT connector in the direction of "open" to the end stop. The triangles on the top of the connectors must be opposite one another.
2. Withdraw the connector.

Note

Pull out the connector at the connector itself, do not pull on the cable.

You have disconnected the SPEED-CONNECT connection.



Routing cables in damp environments

If you are operating the motor in environments in which moisture can arise follow the installation instructions below.

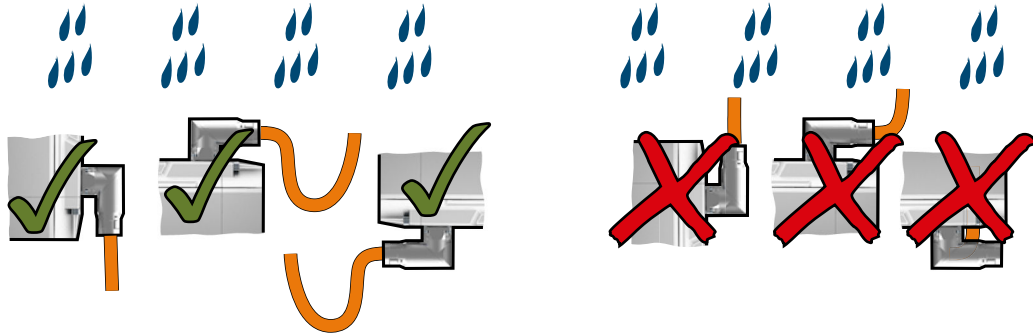

Figure 5-9 Permissible and impermissible cable routing when connecting in a damp environment

5.4.3 Connecting the converter

Install the converter so that you are compliant with local regulations for erecting and installing low-voltage systems.

Carefully observe the following product note about protection against indirect contact:



To protect against indirectly touching part of the motor circuit of a frequency converter and to automatically shut down in the case of a fault according to DIN EN 60364-4-41 (VDE 0100-410) (<http://support.automation.siemens.com/WW/view/en/103474630>)

Protection and monitoring equipment

To provide protection against short-circuits, install the overcurrent devices listed in the Technical data (fuses, circuit breakers or motor protection circuit breakers) between the line supply and converter.

 Technical specifications of the converter (Page 308)

If the apparent impedance of the line supply at the infeed point is not suitable, so that fuses do not rupture in the specified time in the case of insulation failure (ground fault, fault to frame), then you must use additional residual current protective devices RCD (RCCB or MRCD), type B.

- RCCB: Residual current circuit breaker
- MRCD: An MRCD comprises an RCM (differential current monitoring device), a measuring current transducer and a circuit breaker with additional undervoltage release, listed in the Technical data.

To prevent an RCD from unnecessarily tripping as a result of operational leakage currents, the following preconditions must be fulfilled:

- The neutral point of the line supply is grounded.
- Use an RCCB type B with a response limit current of 300 mA. Connect the RCCB in series with the overcurrent protective devices.
- Use a separate RCD for each converter.
- The motor cables are shorter than 50 m (164 ft) and shielded.

Notes for connecting up the converter

Operating displays for converter operation

If, when switching over a function from ON to OFF, an LED or other similar display is not lit or not active; this does not indicate that the device is switched-off or in a no-current condition.

Shield plate

For converters, frame sizes FSB and FSC with 3 AC line connection, the shield plate is integrated in the converter itself. For the other converters, the shield plate is included in the accessories pack of the converter.

Fixing connecting cables

Fix all of the connecting cables using shield clamps or suitable cable ties to the converter shield plate.

Connection of motor holding brake, connector X107

Also connect the conductors for the motor holding brake to the connector at X107, even when you are using a motor without holding brake.

Shielded cables

Shielded cables are required for connecting the OCC cable, the external braking resistor and the fail-safe digital inputs to ensure that the drive functions perfectly.

- Connect the shield at both ends of the cable.
Use the converter shield plate to connect the shield at the converter.
Siemens recommends connecting the shield using the shield clamp that is provided with the prefabricated OCC cable for the motor connection. See the following diagram:
- Use cables with finely-stranded, braided shields.
- Carefully ensure that the shield is not interrupted or broken.

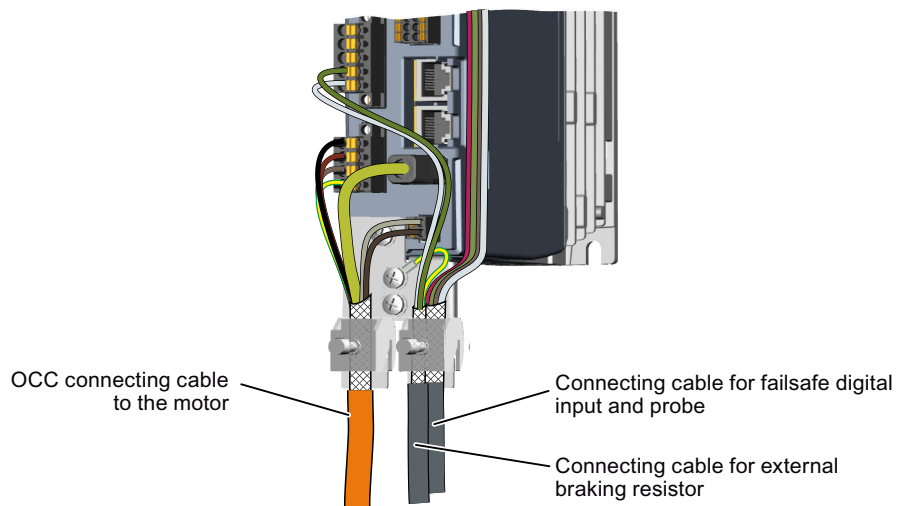
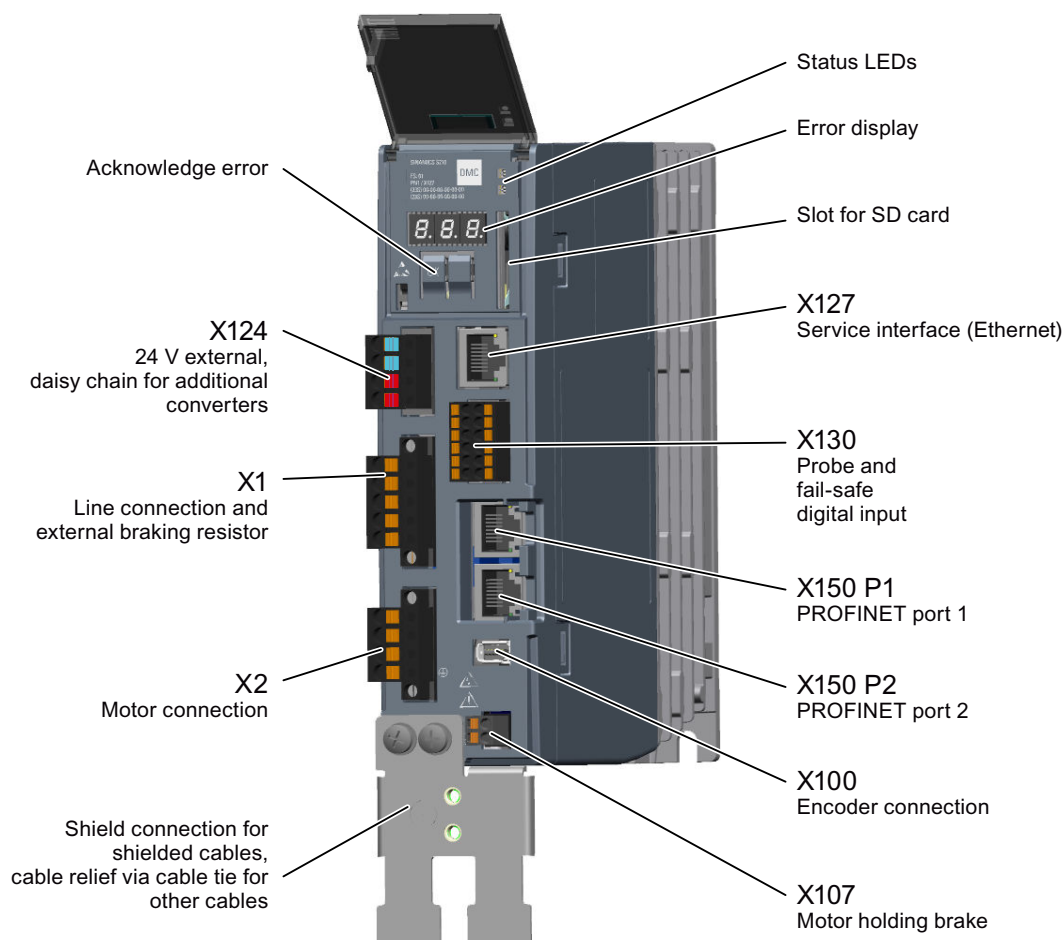

Figure 5-10 Shield support with shield plate and shield clamps for prefabricated OCC cable shown using an example of a converter with 1 AC line connection

Connections and operating elements of the converter with 1 AC line connection



Connectors X1, X2, X107, X124 and X130 are included in the scope of delivery of the converter.

Encoder connector X100 is included with the OCC cable.

You require Ethernet cables with RJ45 connectors to connect service interface X127 - as well as for PROFINET ports X150 P1 and X150 P2.

Connections and operating elements of the converter with 3 AC line connection

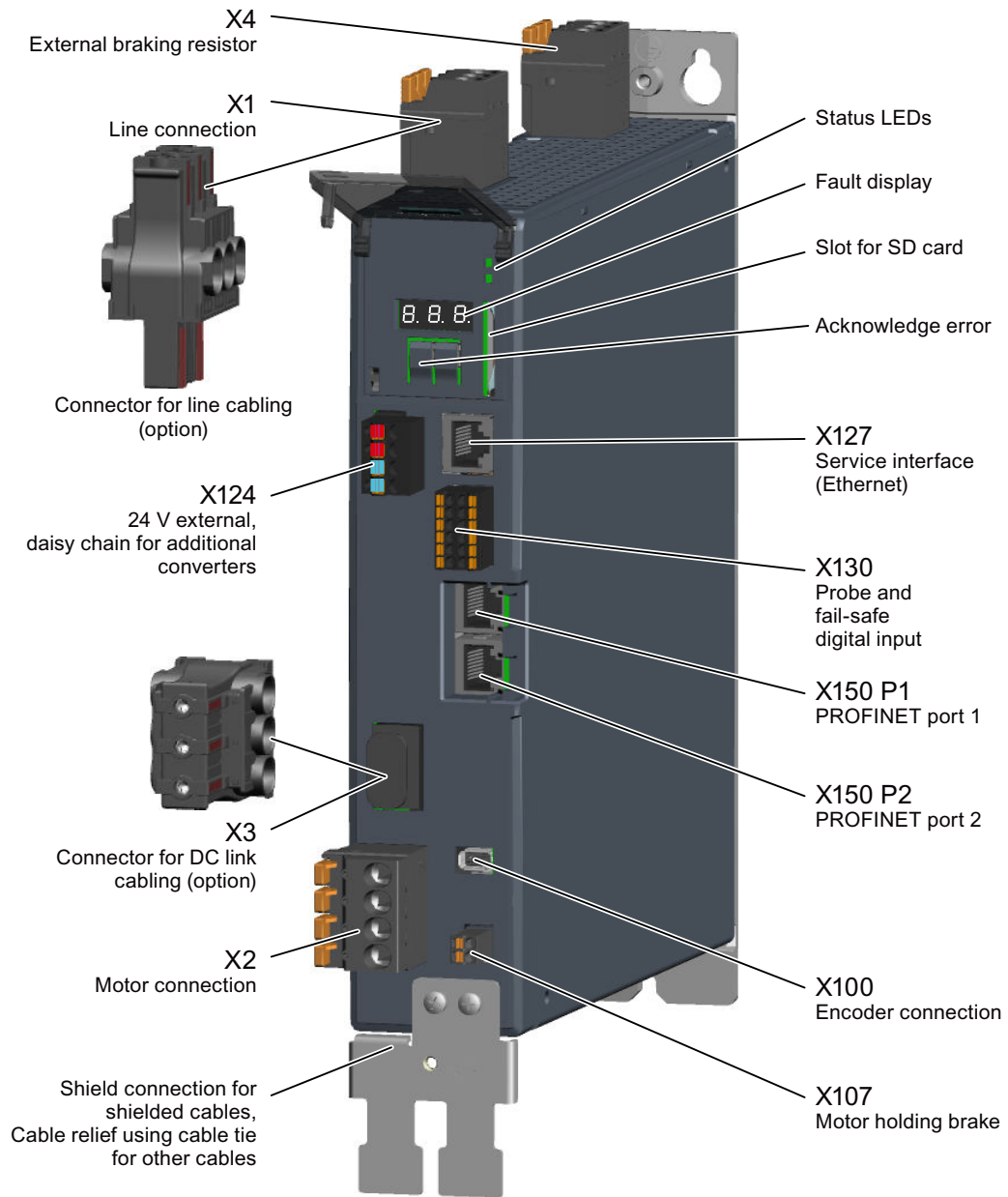

Connectors X1 standard, X2, X4, X107, X124 and X130 are included in the scope of delivery of the converter.

Encoder connector X100 is included with the OCC cable.

You require Ethernet cables with RJ45 connectors to connect service interface X127 - as well as for PROFINET ports X150 P1 and X150 P2.

You must separately order the connectors for line supply cabling X1 and for DC link cabling X3 as required.

 Connectors and cables for line and DC link cabling (Page 340)

5.4.4 Converters with 1 AC line connection

5.4.4.1 Connecting the MOTION-CONNECT cable to the converter

In addition to the motor connections, the MOTION-CONNECT cable from the motor to the converter also includes the conductors for the encoder and the motor holding brake.

NOTICE

Damage to the device by connecting other motors or devices

Connecting other devices (motors, encoders) can destroy the converter or the connected device.

- Only connect 1FK2 motors to the converter.
- Use only MOTION-CONNECT cables from Siemens or cables that you have fabricated yourself with the correct pin assignment.

Connecting the motor cable to the converter

Connect conductors U, V, W of the MOTION-CONNECT cable to connector X2 of the converter as shown below.

Connect the shield of the MOTION-CONNECT cable to the shield plate through a large surface area. Use commercially available clamps, the clamps supplied with the prefabricated cable or the shield connection clamps supplied as accessories.

The terminals are spring-loaded terminals.

Color coding for MOTION-CONNECT cables: Phase U = brown, phase = V black, phase W = gray

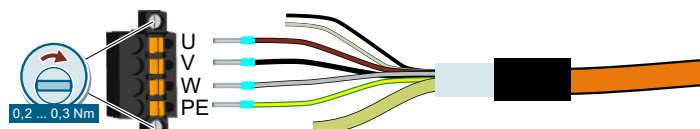

Figure 5-11 X2 - motor connection

Permissible conductor cross-sections for single-conductor connection or for connecting flexible cables with end sleeves:

- 0.2 mm² ... 2.5 mm²
- AWG: 26 ... 12

Connecting the encoder to the converter

The cables and the connector for the encoder connection are part of the MOTION-CONNECT cable from the motor to the converter.

Insert the Siemens IX connector in the X100 socket connector as shown in the diagram.

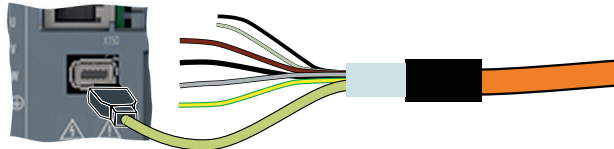

Figure 5-12 X100 - encoder connection

Connecting the motor holding brake

The cables for the motor holding brake are part of the MOTION-CONNECT cable from the motor to the converter.

Connect the cables to the connector X107 of the converter as shown in the diagram.

The terminals are spring-loaded terminals.

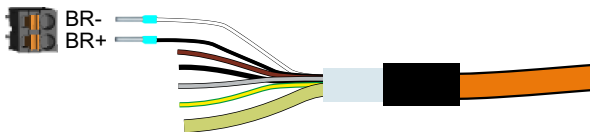

Figure 5-13 X107 - connection for the motor holding brake

Permissible conductor cross-sections:

- For single-conductor cables or for flexible cables with end sleeves without plastic protection:
 - 0.25 mm² ... 1.5 mm²
 - AWG: 24 ... 16
- For flexible cables with end sleeves with plastic protection:
 - 0.25 mm² ... 0.75 mm²
 - AWG: 24 ... 19

Note

Connection of motor holding brake, connector X107

Also connect the conductors for the motor holding brake to the connector at X107, even when you are using a motor without holding brake.

5.4.4.2 Connecting the converter to the line supply

Connect the line supply as shown in the following to connector X1 of the converter. Connect the protective conductor with a cable lug and an M4 screw to the shield plate of the converter.

If you do not use a shield plate, then you must connect the protective conductor directly at the device.

The terminals are spring-loaded terminals.

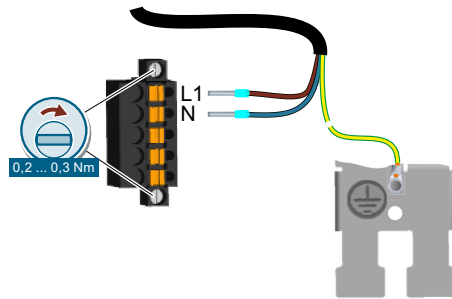

Figure 5-14 X1 - line connection 1 AC

Permissible conductor cross-sections for single-conductor connection or for connecting flexible cables with end sleeves:

- 0.2 mm² ... 2.5 mm²
- AWG: 26 ... 12

5.4.4.3 Connecting an external braking resistor

If you are using the internal braking resistor, DCP and R2 must be jumpered.

If you are using an external braking resistor, DCP and R2 must not be jumpered. Connect the braking resistor via the DCP and R1 terminals.

The terminals are spring-loaded terminals.

The permissible cable length cable length is 3 m.

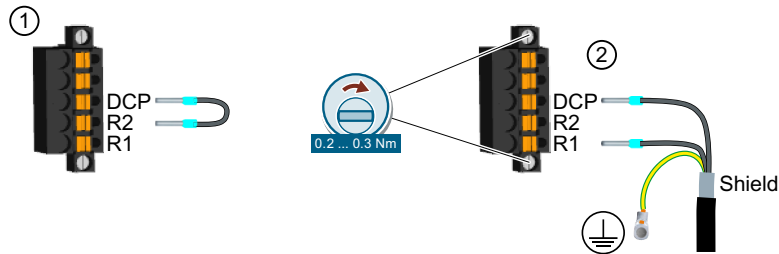

- ① Jumper between DCP and R2 when you use the internal braking resistor.
The jumper is included in the scope of delivery of the converter
- ② Connect an external braking resistor
Protective conductor connection and shield support via the shield plate

Figure 5-15 X1 - connection for an external braking resistor

Permissible conductor cross-sections for single-conductor connection or for connecting flexible cables with end sleeves:

- 0.2 mm² ... 2.5 mm²
- AWG: 26 ... 12

5.4.5 Converter with 3 AC line connection

5.4.5.1 Connecting the MOTION-CONNECT cable to the converter

In addition to the motor connections, the MOTION-CONNECT cable from the motor to the converter also includes the conductors for the encoder and the motor holding brake.

NOTICE

Damage to the device by connecting other motors or devices

Connecting other devices (motors, encoders) can destroy the converter or the connected device.

- Only connect 1FK2 motors to the converter.
- Use only MOTION-CONNECT cables from Siemens or cables that you have fabricated yourself with the correct pin assignment.

Connecting the motor cable to the converter

Connect conductors U, V, W of the MOTION-CONNECT cable to connector X2 of the converter as shown below.

Connect the shield of the MOTION-CONNECT cable to the shield plate through a large surface area. Use commercially available clamps, the clamps supplied with the prefabricated cable or the shield connection clamps supplied as accessories.

The terminals are spring-loaded terminals.

Color coding for MOTION-CONNECT cables: Phase U = brown, phase = V black, phase W = gray

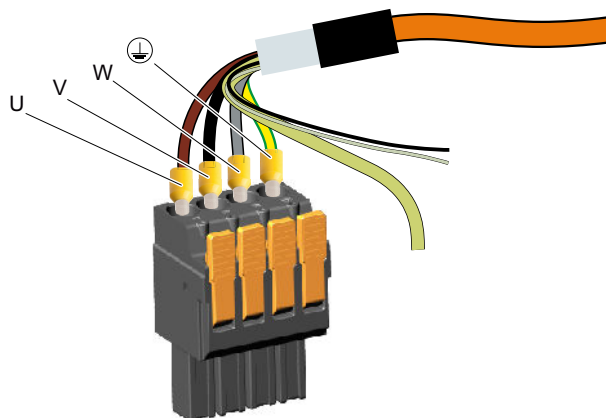

Figure 5-16 X2 - motor connection

Permissible conductor cross-sections for single-conductor connection or for connecting flexible cables with or without end sleeves:

- 0.75 mm² ... 6 mm²
- AWG: 18 ... 10

Connecting the encoder to the converter

The cables and the connector for the encoder connection are part of the MOTION-CONNECT cable from the motor to the converter.

Insert the Siemens IX connector in the X100 socket connector as shown in the diagram.

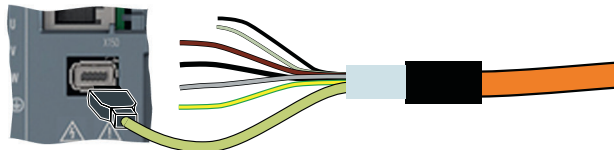

Figure 5-17 X100 - encoder connection

Connecting the motor holding brake

The cables for the motor holding brake are part of the MOTION-CONNECT cable from the motor to the converter.

Connect the cables to the connector X107 of the converter as shown in the diagram.

The terminals are spring-loaded terminals.

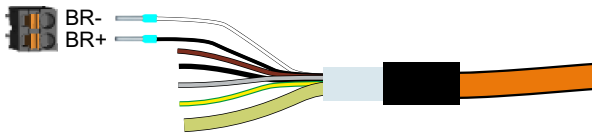

Figure 5-18 X107 - connection for the motor holding brake

Permissible conductor cross-sections:

- For single-conductor cables or for flexible cables with end sleeves without plastic protection:
 - 0.25 mm² ... 1.5 mm²
 - AWG: 24 ... 16
- For flexible cables with end sleeves with plastic protection:
 - 0.25 mm² ... 0.75 mm²
 - AWG: 24 ... 19

Note

Connection of motor holding brake, connector X107

Also connect the conductors for the motor holding brake to the connector at X107, even when you are using a motor without holding brake.

5.4.5.2 Connecting the converter to the line supply

Spring-loaded terminals are provided with the converter to connect it to the line supply.

If you connect several converters in parallel, the optional terminals for the line cabling are available to connect to the line supply. This significantly reduces the wiring costs.

Both connection options are shown below.

Connecting a converter with standard terminals

The terminals are spring-loaded terminals.

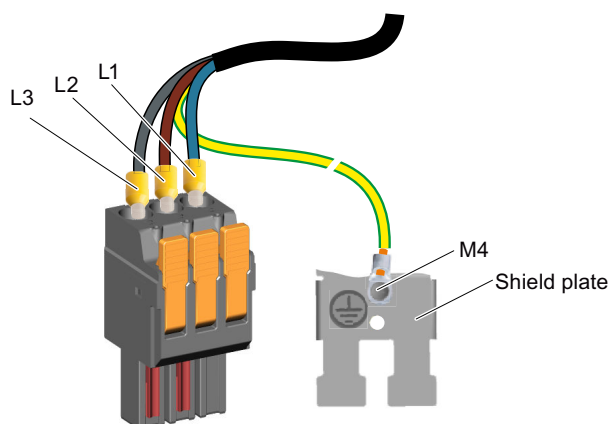

Figure 5-19 X1 - line connection 3 AC - standard

Permissible conductor cross-sections for single-conductor connection or for connecting flexible cables with or without end sleeves:

- 0.75 mm² ... 6 mm²
- AWG: 18 ... 10

Connecting a converter with terminals for the line cabling

The connectors for the line cabling are not included in the scope of delivery of the converter.

Ordering data:

Connectors and cables for line and DC link cabling (Page 340)

The permissible cables for the line cabling as well as the installation instructions are provided in the following Section:

 Connecting the line cabling and DC link coupling (Page 168)

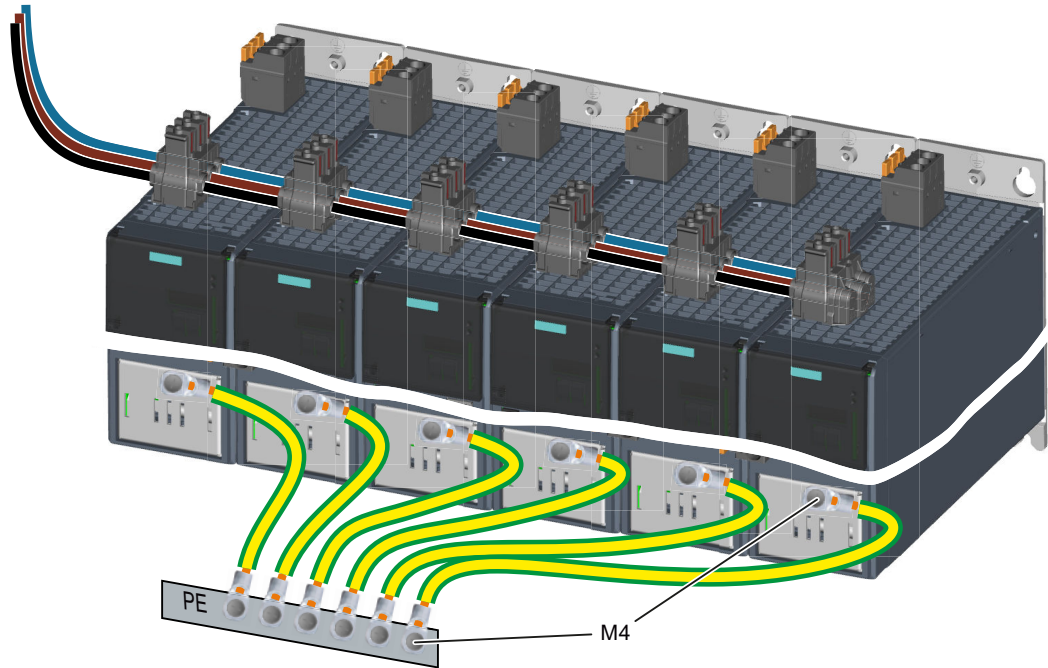



Figure 5-20 X1 - line connection 3 AC - cabling

5.4.5.3 DC link cabling

The connectors for the DC link coupling are not included in the scope of delivery of the converter.

Ordering data:

 Connectors and cables for line and DC link cabling (Page 340)

The permissible cables for the DC link cabling as well as the installation instructions are provided in the following Section:

 Connecting the line cabling and DC link coupling (Page 168)

The preconditions for the DC link coupling are described in the following Section:

 DC link coupling (Page 70)

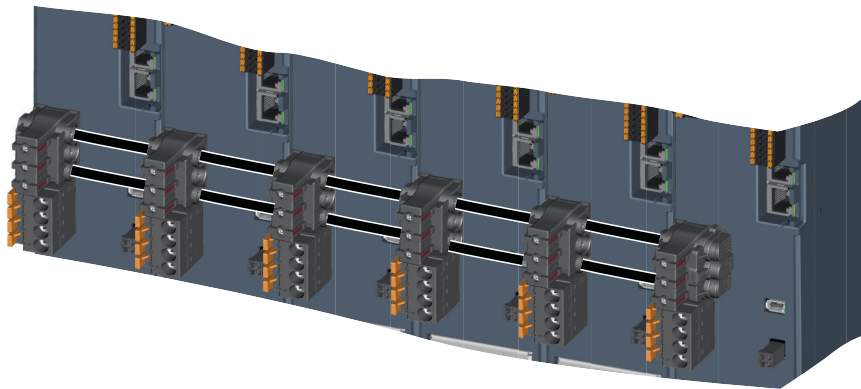

Figure 5-21 X3 - connecting the DC link cabling

5.4.5.4 Connecting the line cabling and DC link coupling

Permissible cables for the line cabling and DC link coupling

Permissible cables for IEC applications:

Use the following cables for the line connection and for the DC link coupling:

- 16 mm², Class 5 (finely-stranded, PVC-insulated), H07V2-K according to DIN EN 50525-2-31
- Outer diameter 6.7 mm ... 8.1 mm

Permissible cables for UL and cUL applications:

Only use copper cables with the following properties for the line connection and the DC link coupling:

- AWG 6, with PVC insulation, with or without nylon jacket, with 19 stranded conductors.
- Types: MTW, THHW, THW, THW-2, THHN, THWN-2, TW, TWN
- CSA types: TW, TWU, TWN75, TW75, TWU75, T90. It is not permissible that other cables are used.

Establishing the cabling

1. Connect the converters with one another using the insulated cables. Tighten the connector screws with a torque of 3 Nm. Please note that you must tighten the screws so that the red marking on the connector is no longer visible. The electrical contact has not been reliably established if the red marking is still visible.
2. At the end connectors, allow the cable to protrude by 3 mm ... 5 mm. Markings are provided on the end caps showing the permissible amount of protrusion. To do this, place the end cap on the connector as shown in the diagram and then pinch off the conductors.

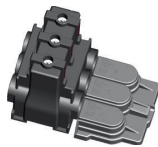

3. For the line cabling, close and seal the connector of the last converter using an end cap - and for the DC link coupling of the first and last converter using end caps.

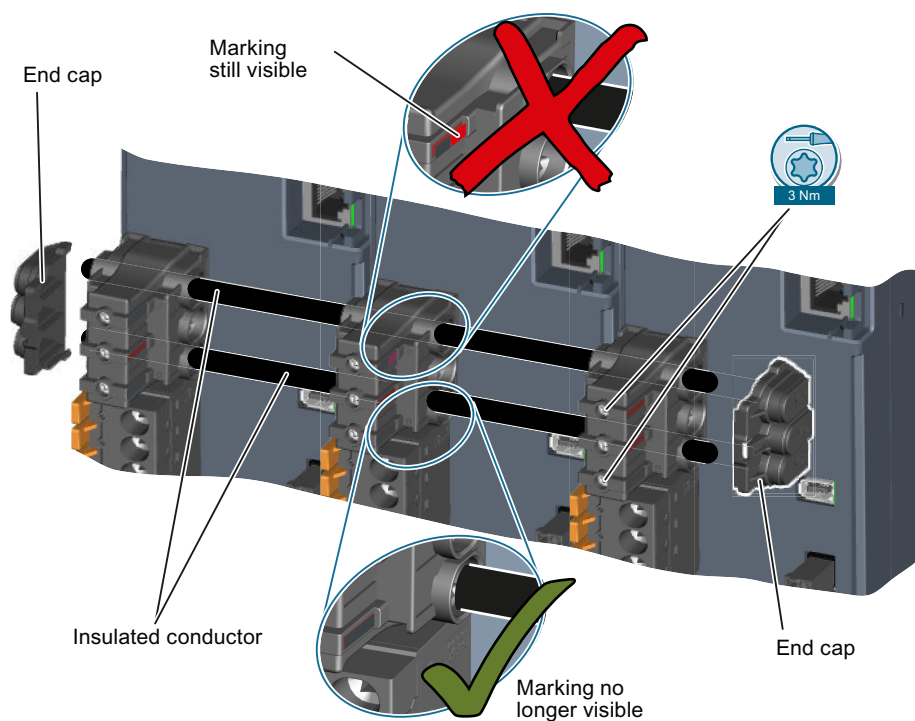

Figure 5-22 Establishing the line cabling - example for the DC link

Note

The cables for the line and DC link coupling may only be used once.

Further, comply with the notes provided in the documentation supplied with the contactors.

5.4.5.5 Connecting an external braking resistor

DCP and R2 must be jumpered if you are not using an external braking resistor.

If you are using an external braking resistor, DCP and R2 must not be jumpered. Connect the braking resistor via the DCP and R1 terminals.

The terminals are spring-loaded terminals.

The permissible cable length is 10 m.

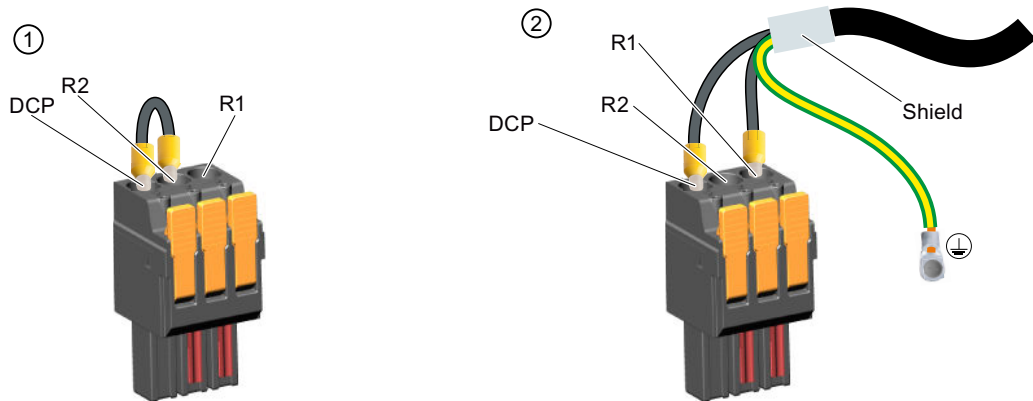

- ① Jumper between DCP and R2 when you use the internal braking resistor.
The jumper is included in the scope of delivery of the converter
- ② Connect an external braking resistor
Protective conductor connection and shield support via the back panel of the device

Figure 5-23 X4 - connection for an external braking resistor

Permissible conductor cross-sections for single-conductor connection or for connecting flexible cables with or without end sleeves:

- 0.75 mm² ... 6 mm²
- AWG: 18 ... 10

5.4.6 Additional connections at 1 AC / 3 AC converters

5.4.6.1 Connecting digital inputs and the external 24 V supply

Connecting the external 24 V supply

Connect a 24 V power supply to the converter.

The terminals are spring-loaded terminals

Permissible cable length: 30 m

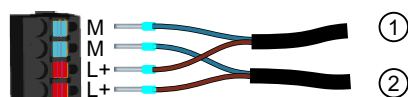

- ① 24 V external
- ② Loop-through for additional converters

Figure 5-24 X124 - 24 V external

Permissible conductor cross-sections for single-conductor connection or for connecting flexible cables with end sleeves:

- 0.2 mm² ... 2.5 mm²
- AWG: 26 ... 12

Connecting digital inputs

Digital inputs DI 0 and DI 1 are high-speed digital inputs and can be used as measuring inputs.

Digital Inputs DI 2 and DI 3 form a Failsafe Digital Input.

You can connect the temperature monitoring for an external braking resistor to DI 4.

When you use the temperature monitoring function, the converter shuts down the motor if the external braking resistor temperature becomes too high.

The terminals are spring-loaded terminals

Permissible cable length: 30 m

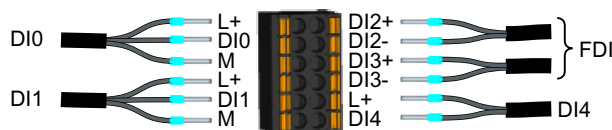

Figure 5-25 X130 - connector for digital inputs

5.4 Connecting the converter and the motor

Permissible conductor cross-sections:

- For single-conductor connection:
 - 0.2 mm² ... 1.5 mm²
 - AWG: 24 ... 16
- For flexible cables with end sleeves:
 - 0.25 mm² ... 1.5 mm²
 - AWG: 24 ... 16
- For flexible cables with end sleeves with plastic protection:
 - 0.25 mm² ... 0.75 mm²
 - AWG: 24 ... 19

The three "L+" terminals are designed as power supply for external sensors. They are short-circuit proof and provide a max. of 50 mA per sensor. A sensor short-circuit interrupts the power supply for all three sensors.

5.4.6.2 Connecting service interface and PROFINET

Connect your commissioning device using an Ethernet cable to the service interface (socket X127).



The transmission rates are 10 Mbit/s or 100 Mbit/s.

Connect the converter with PROFINET cables with RJ45 FastConnect connectors or with PROFINET patch cables (see accessories) via the sockets X150 P1 and X150 P2 to the PROFINET network.

Table 5-8 Pin assignment for X127, X150 P1 and X150 P2

	Pin	Pin assignment	Explanation
	1	RXP	Receiving data +
	2	RXN	Receiving data -
	3	TXP	Sending data +
	4	Reserved	
	5	Reserved	
	6	TXN	Sending data -
	7	Reserved	
	8	Reserved	

Permissible cable length for PROFINET (terminals X150 P1 and X150 P2): 100 m

Permissible cable length for the service interface (terminal X127): 10 m

5.4.7 Connection example

Connection example for converters with 1 AC line connection

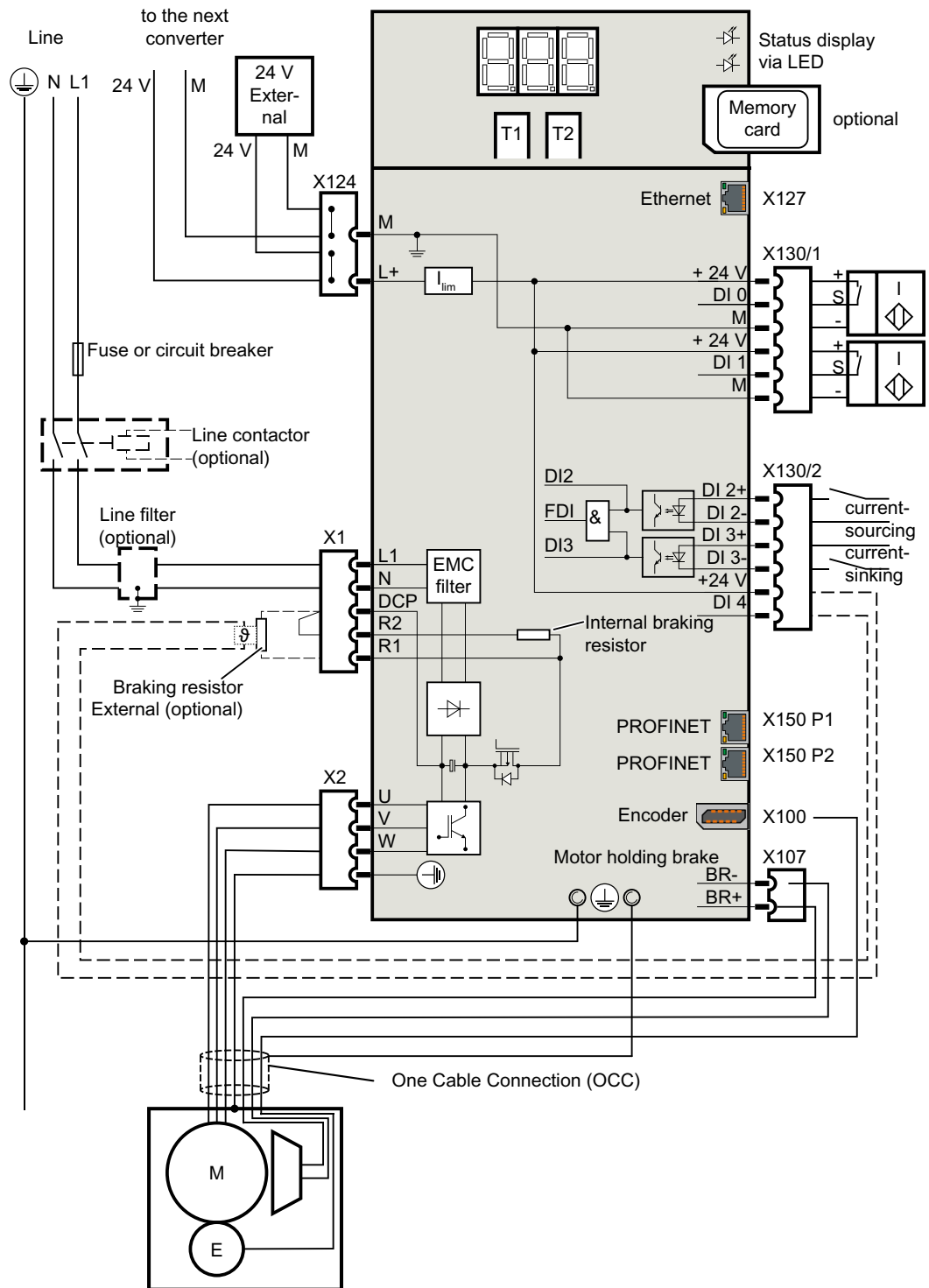

Connection example for converters with 3 AC line connection

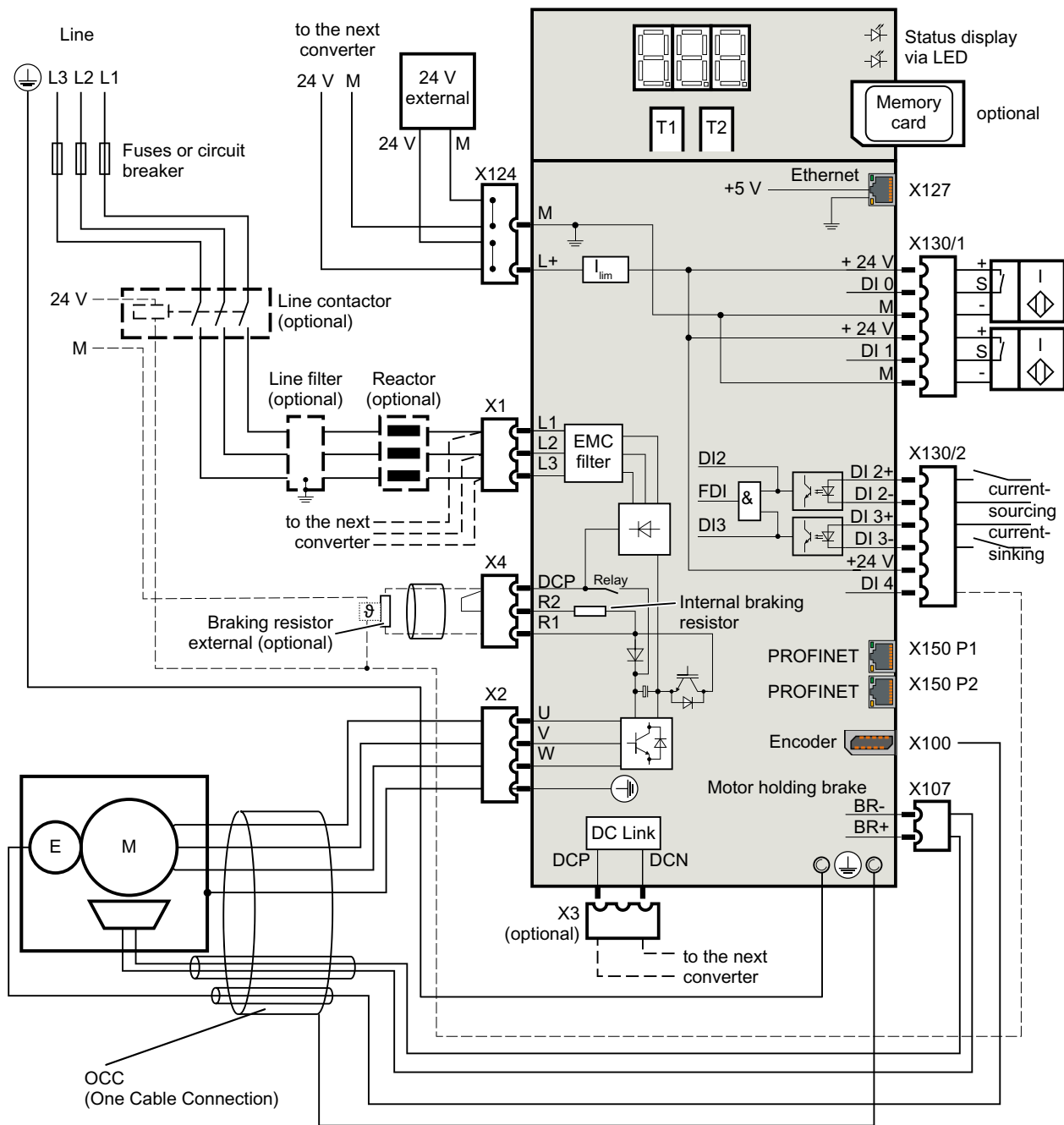

5.4.8 Connection example of the Failsafe Digital Input

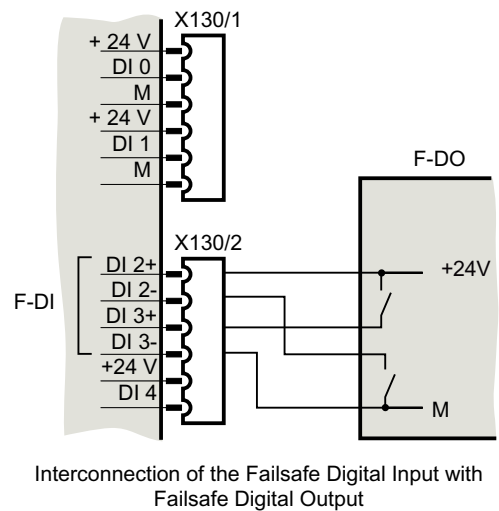
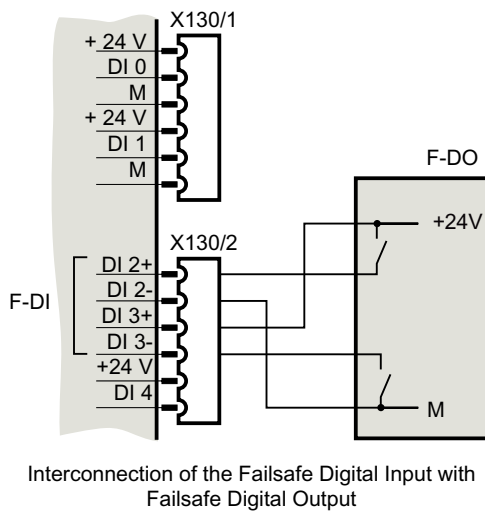
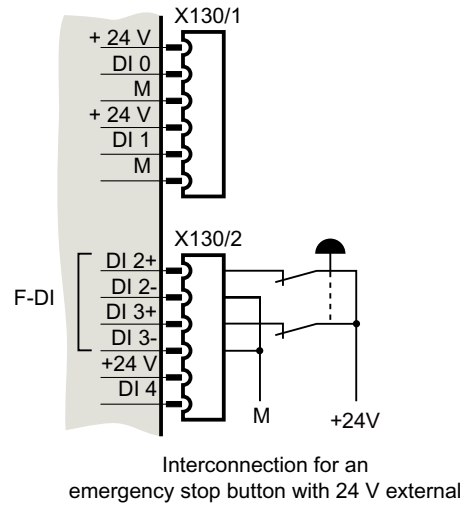
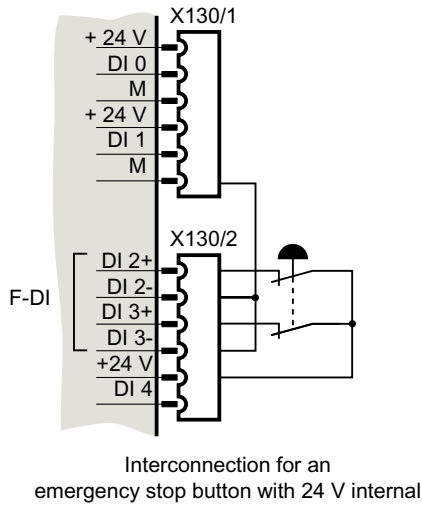

Commissioning and diagnostics using the web server

6

The converter settings are made via the web server integrated in the converter.

Supported browsers

The web server integrated in the converter supports the following browsers:

Commissioning device	Operating system	Supported browsers
PC	Windows, version 7 or higher	<ul style="list-style-type: none">• Microsoft Internet Explorer, version 11 or higher• Microsoft Edge, version 14 or higher• Mozilla Firefox, version 62 or higher• Google Chrome, version 69 or higher
Smartphone/ tablet	Apple iOS, version 12 or higher	<ul style="list-style-type: none">• Google Chrome, version 69 or higher• Safari, version 12.0 or higher
	Android, version 4.4.4 or higher	<ul style="list-style-type: none">• Google Chrome, version 69 or higher

If the web server does not respond, or if buttons are inactive or are not labeled, although the converter is not fully utilized with internal calculations, load the web server page again as follows:

- from the PC via <F5>
- from the smart phone or tablet via 

6.1 Fundamentals

6.1.1 Accessing the web server

For access to the web server, the following interfaces are available on the converter:

- Service interface X127 (standard)
- PROFINET interface X150

Access via the service interface X127

The web server is accessed per default via the service interface X127.

The service interface has the following default setting:

- IP address: 169.254.11.22
- Subnet mask: 255.255.0.0

For commissioning or for diagnostics using mobile devices, interface X127 can be temporarily connected to an external WLAN access point, and an IP address can be sourced via DHCP.

Carefully comply with the following safety instructions.

Note

Using the X127 interface

Ethernet interface X127 is intended for commissioning and diagnostics, which means that it must always be accessible.

Carefully note the following restrictions for the X127 interface:

- Only local access is permissible
- No networking - or only local networking in a closed and locked electrical cabinet is permissible

If it is necessary to remotely access the electrical cabinet, then you must apply additional security measures so that misuse through sabotage, data manipulation by unqualified persons and intercepting confidential data is completely ruled out.

 [Industrial Security \(Page 24\)](#)

Access via PROFINET interface X150

As an alternative to access via X127, you can also access the web server via PROFINET interface X150.

Access via PROFINET interface

 [Configuring the IP connection \(Page 243\)](#)

The IP addresses of the service and PROFINET interfaces must not be in the same subnet.

Preparations

1. Install the motor and converter according to the specifications in the following section:
 Installing (Page 139)
2. Mount the motor on the mechanical system. Connect the motor to the converter.
3. Connect the converter to your commissioning device via the service interface (X127).
4. Switch the converter on.
The converter powers up and reads the motor data.
5. Start the browser for commissioning.
6. Enter the IP address of the converter in the input line of your browser.
Default IP address: 169.254.11.22

Interfaces and connection type

Using the default configuration of the web server, you can access the SINAMICS frequency converter using the service interface (X127) - both via an HTTP connection as well as via an encrypted HTTPS connection.

In the standard configuration, interface X150 is deactivated for web server access operations. If the X150 interface is activated to access the web server, then access can only take place via a secure HTTPS connection.

For details on this, see:

 "Configuring the IP connection (Page 243)"

NOTICE

Software manipulation when using non-encrypted connections (HTTP)

The HTTP protocol transfers data without encryption. This facilitates password theft, for example, and can lead to data manipulation by unauthorized parties and thus ultimately to damage.

- Limit access to HTTPS connections so that all data is transferred encrypted.

6.1.2 Users and access rights

There are 2 pre-defined users for access to the converter via the Web server:

- Administrator
The user "Administrator" has full access to the converter data displayed in the web server. A password is always required for access as administrator.
- SINAMICS
The "SINAMICS" user has restricted access rights, see the following table. Per default, a password is not assigned for the SINAMICS user.

Note

Configuring passwords for the users

You can configure the passwords of the two users in the system settings with administrator rights (see Chapter "Setting or changing user accounts (Page 240)").

The following access rights apply for the users of the web server:

Functions of the web server	Access rights	
	Administrator	SINAMICS
Home page Password input	Write	Write
Perform commissioning <ul style="list-style-type: none"> • Change drive name • Perform One Button Tuning • Use control panel 	Write	None ¹⁾
Safety settings <ul style="list-style-type: none"> • Make commissioning settings • Check commissioning in read-only mode • Diagnostics 	Write Read Read	None ¹⁾ None ¹⁾ Read
Diagnostics <ul style="list-style-type: none"> • Display communication settings • Adapt message list • Acknowledge alarms 	Write Write Write	Write Write Write
Settings <ul style="list-style-type: none"> • Set limits • Adapt brake control • Adapt digital inputs • Adapt parameter list • Change parameterization 	Write Write Write Write Write	Read Read Read Write Read
Backup and restore <ul style="list-style-type: none"> • Back up parameter settings externally • Load externally backed-up parameter settings • Restoring factory settings 	Write	None ¹⁾
Adapt system settings <ul style="list-style-type: none"> • Set user accounts • Configure IP connection • Configure system time 	Write	None ¹⁾
Save permanently (copy RAM to ROM)	Write	None ¹⁾
Call support information	Read	Read

¹⁾ This function is not displayed for a "SINAMICS" user.

6.1.3 Dialog screen forms in the web server

You make most of the important converter settings in the dialog screen forms of the web server. The web pages are subdivided into an information part (①), a graphic part (②) and a table part (③) with parameters.

Example of a dialog screen form

Switching on inhibited - set "OC/OFF2" = "1"

Parameters > Limits

Illustration

```

    graph LR
      nset((nset)) --> DL[Direction limit]
      DL --> SL[Speed limit]
      SL --> SC[Speed controller]
      SC -- Mset --> TCL[Torque / current limit]
      TCL --> CC[Current controller]
      CC --> M((M))
      M --> E((E))
      E -- nact --> SC
  
```

Parameter name	Value	Unit
Maximum speed	7300	rpm
Torque limit motoring	4.45	Nm
Torque limit regenerating	-4.45	Nm
Torque limit motoring active	4.45	Nm
Torque limit when regenerating active	-4.45	Nm

In most cases you will be able to work with the parameters in the table directly below the diagram.

In some cases, you must make the parameter settings or read out values which can only be found in the parameter list of the converter.

Details on this are provided in Section:

Adapting parameters (Page 206)

6.1.4 Changing parameter values

The parameters are subdivided into adjustable parameters and display parameters.

Individual parameters in the parameter list are shown in precisely the same way as in the dialog screen forms.

More information about adapting the parameter list is provided at:

 Adapting parameters (Page 206)

Adjustable parameters

Adjustable parameters are identified by a frame in which you can either enter values or select values via a drop-down menu. Invalid values have a red background and are rejected.

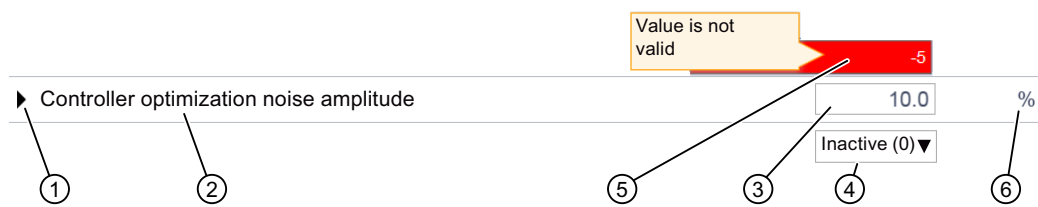

① Adjustable parameters with this icon have several indices or bit arrays

② Name of the parameter

③ Input field for the parameter value

④ Select the parameter value via the drop-down menu

⑤ Invalid value

⑥ Unit of the parameter

Figure 6-1 Example of the representation of an adjustable parameter

Display parameters

Display parameters are for information purposes only and cannot be changed.



① Display parameters with this icon have several indices or bit arrays

Figure 6-2 Example of the representation of a display parameter

6.1.5 Logging on for the first time and assigning an administrator password

When logging onto the converter for the first time you must assign the administrator password.

Accessing the converter when the administrator password has been lost

Note

Remember the password or store it in a secure place that cannot be accessed by unauthorized persons.

If the password is lost, then you must reset the converter to the factory settings as described at the following link.

 [Reset converter/password - restore the state when originally delivered \(Page 270\).](#)

Assigning the administrator password

You must log in as administrator to obtain complete access to the converter. A password is required for access as administrator.

Proceed as follows to assign an administrator password:

1. Switch the converter on.
2. Connect the commissioning device to the service interface (X127) using a LAN cable.

6.1 Fundamentals

3. Call the web server of the converter (standard IP address: 169.254.11.22).
The following screen form is only displayed if an administrator password has still not been assigned.

If, within ten minutes after the line cable was inserted, no password is assigned, then the display transitions into the login screen (Page 186). In order to return to the "Initial Setup" screen form, you must withdraw the LAN cable from the service interface and reinsert again.

Initial Setup

i To receive access to the drive you must log in as Administrator within ten minutes. Assign a password for this.

To protect against unauthorized access choose a secure password, consisting of at least eight characters, uppercase and lowercase letters. Numbers and special characters (eg. ?!% +) are also recommended.

Password

Confirm password

Security information

In order to protect plants, systems, machines and networks against cyber threats, it is necessary to implement - and continuously maintain - a holistic, state-of-the-art industrial security concept. Siemens' products and solutions only form one element of such a concept.

<http://www.siemens.com/industrialsecurity>

OK

Figure 6-3 Prompt to enter the administrator password

4. Enter an administrator password in the "Password" field.

Note

To protect against unauthorized access, by an attacker, for example, select a secure password that consists of:

- At least 8 characters
- Uppercase and lowercase letters
- Numbers and special characters (e.g.: ?!%+ ...)

It is not permissible that the password is used elsewhere.

Checking the password

The length of the password is checked by the converter. There is no check for uppercase and lowercase letters and special characters!

5. Repeat the password in the "Confirm password" field.
If the input is not identical in both fields, the "OK" button is not enabled.

6. Confirm the password that you entered with "OK".
7. The display changes to the Login screen form. Log in there with the administrator password.
 Figure 6-4 Login screen (Page 186)

6.1.6 Login/logout

In order to be able to work with the web server, you must be logged in as "SINAMICS" or "Administrator" user.

For commissioning, you must be logged in as "administrator".

Logging in to the web server

1. Enter the IP address for the converter in the entry line of your browser (default IP address: 169.254.11.22).
The password prompt appears in the browser.

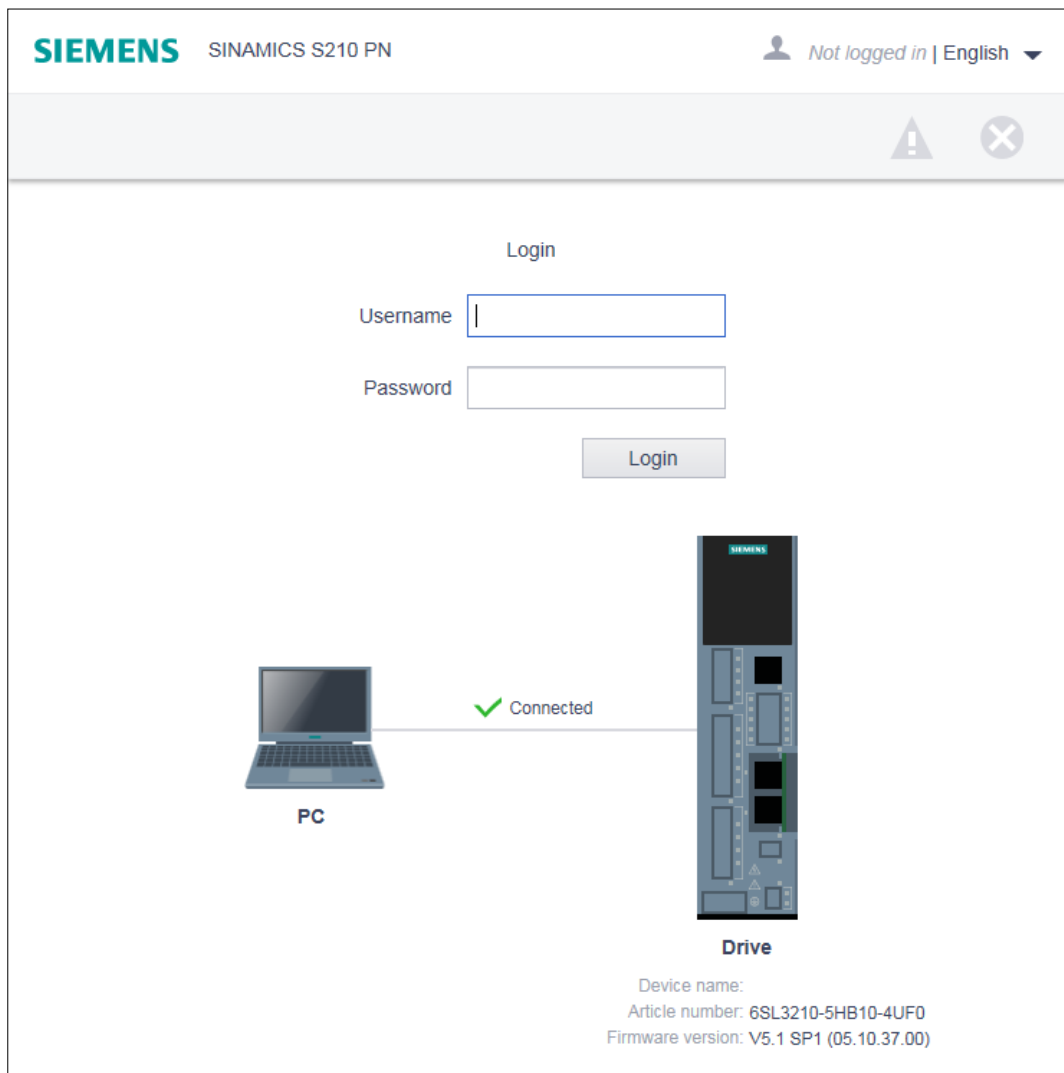



Figure 6-4 Login screen

2. Enter the name of the user (Administrator or SINAMICS) in the "User name" field.

3. Then enter the password of the user.
Per default, a password is not assigned for the "SINAMICS" user. In this case, you can skip the password input.
4. Click "Login".
When you have successfully logged in, the browser displays the user name at the top right. The most important elements of your drive system are shown centrally in the view:

Logging out from the web server

1. In the window, click the  icon with the user name at the top right.
2. Click "Logout".
If have changed the converter settings, a save prompt appears. You can select here whether to save or discard the changes.

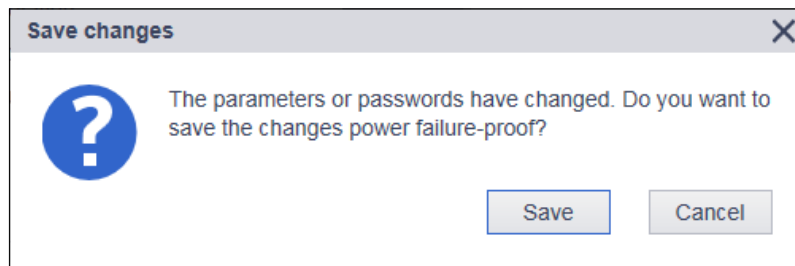



Figure 6-5 Save prompt when logging out

3. If you want to save the changes, click "Save changes".

Automatic logout

If you are not using the web server, access to the web server is automatically logged out after 10 minutes. You must log in again to access the web server.

Any changes that you made are not lost when automatically logging out. After logging in again, you have the option of opening a memory dialog via .

 Saving data in a non-volatile fashion (Page 193)

6.1.7 Start page of the web server

After you have logged in, the web server will display the following start page:



- ① Navigation bar
- ② Status bar with the following contents:
 Top: Device designation / drop-down list for the language selection and to log out.
 Bottom: Name of the converter (if entered) / Status of the converter / Fault and warning messages
- ③ Navigation-dependent main window
- ④ Action bar (from left to right): Support information / Call control panel / Save retentively (RAM to ROM)

Figure 6-6 Basic structure of the web server

6.1.7.1 Navigating in the web server

The web server provides the following options for navigating:

- Multi-level navigation bar of the web server
- In the active web server view via drop-down lists

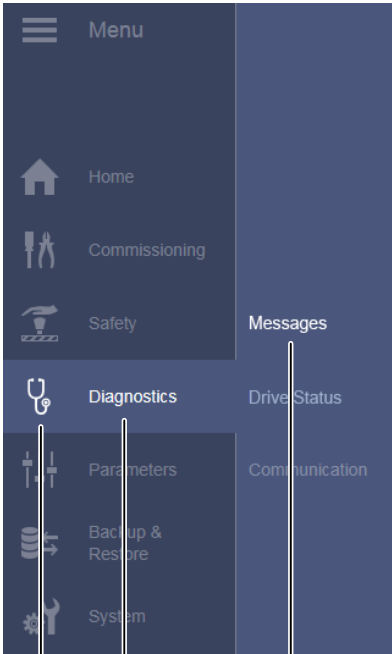
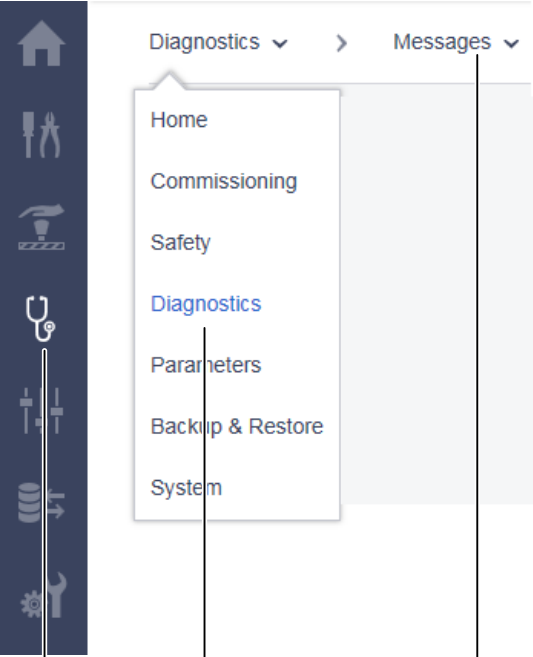
Navigation via the navigation bar	Navigation via drop-down lists (drop-down menus)
<p>The navigation bar of the web server has a multi-level structure. Example:</p>  <p>① Main menu as icon</p> <p>② Main menu in text format</p> <p>③ Submenus of the active main menu</p>	<p>Alternatively, the screen forms can also be called in the active view of the web server via drop-down lists (drop-down menus). This also allows easy navigation in small displays (smartphone).</p>  <p>① Main menu as icon</p> <p>② Main menu in text format</p> <p>③ Submenus of the active main menu</p>

- ① Main menu as icon
- ② Main menu in text format
- ③ Submenus of the active main menu

6.1.7.2 Calling Support information

You can call the Support addresses for the SINAMICS S210 via the footer of the Web server.

1. Click "Support" in the footer of the Web server.
The following information is displayed:

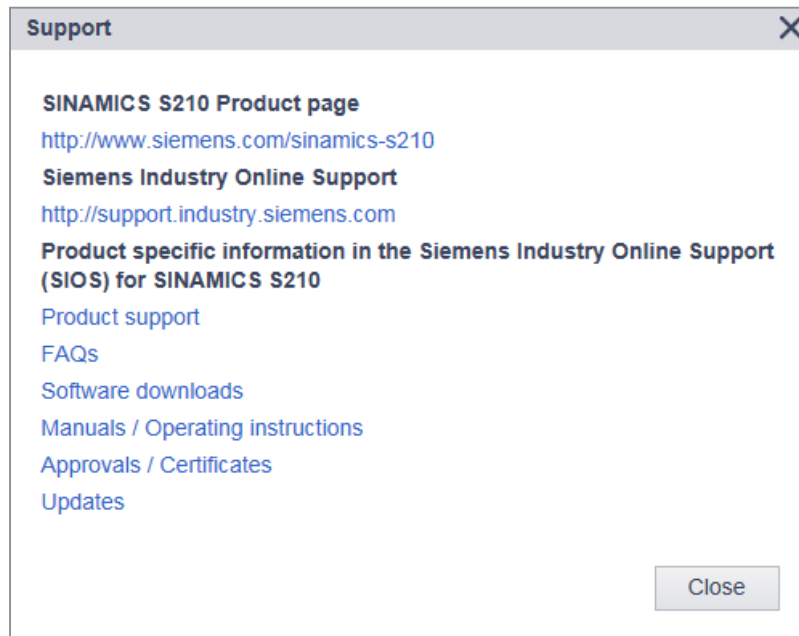

Figure 6-7 Support addresses

Open or copy the required support addresses via the links.

2. Click "Close" to close the Support information.

6.1.7.3 Using the control panel

The control panel is used to control and monitor the drive during the commissioning phase. Apply the safety measures required when using the control panel. The control panel offers the following functions:

- Checking missing enables
- Testing drive movements or traversing manually
- Monitoring drive movements

Call the control panel

You can always call the control panel when you access the web server in the converter with your commissioning device.

1. To call the control panel, click "Control panel" in the footer of the web server. The control panel is started in monitoring mode.

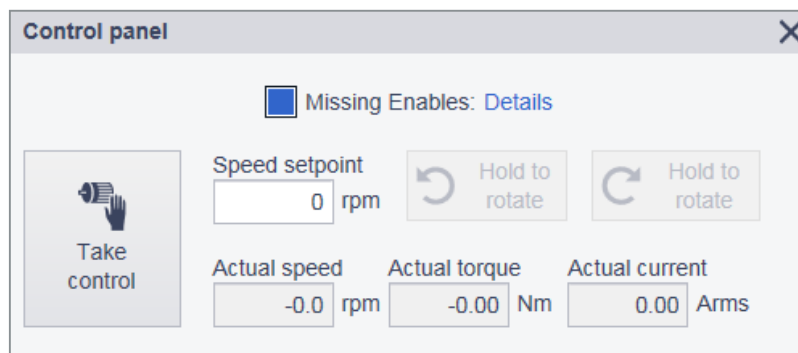

Figure 6-8 Control panel - Monitoring mode

2. To close the control panel again, click the "Control panel" button again in the footer of the web server or on the X at the top right in the header of the control panel.

Control panel in monitoring mode

When all enables are present, the "Missing Enables" line is not displayed and the "Actual speed value", "Actual torque" and "Actual current" display fields show the current values of the drive.

If enables are missing, the motor does not turn. In this case the "Missing Enables" LED lights up in blue.

1. Click the "Click here for details" link to display the details. The "Missing enables" dialog opens:
2. Click "Close" to close the display dialog.

Control panel in control mode

If you assume control, you can test the drive movements or traverse manually.

1. To call the control panel, click the "Control panel" button in the footer of the web server. The control panel is displayed in monitoring mode.
2. Click the "Assume control" button.

6.1 Fundamentals

3. Confirm the "Assume control" confirmation prompt with "Confirm".
The control panel now has master control over the drive. This is indicated by a broken orange line. All other control sources are switched off.

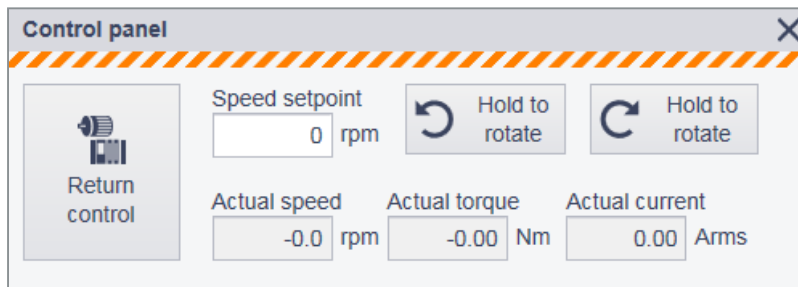

Figure 6-9 Control panel - Control mode

4. To specify a new speed for traversing, click in the "Speed setpoint " field.
The "Speed setpoint" dialog is opened. Define the speed and acknowledge with "OK".
5. To traverse the drive manually, click the "Rotate" button with counterclockwise or clockwise arrow briefly and check the response in the display fields or at the missing enables.
The traversing motion is only performed as long as you activate the button. Traversing motion stops as soon as the button is no longer activated.
The arrow on the buttons indicates the direction of rotation of the motor when rotating clockwise when looking at the motor shaft from the front. For counter-clockwise direction of rotation, the motor runs in the other direction.
Check the correct direction of rotation of the motor shaft.
6. To return master control, click "Return control".
Confirm the confirmation prompt with "Confirm".
7. To close the control panel again, click the "Control panel" button again in the footer of the web server or the X at the top right in the "Control panel" dialog.

6.1.7.4 Saving data in a non-volatile fashion

The changed settings are only saved in the volatile memory of the converter. They are lost when you switch off the drive or close the Web server.

For this reason, it is important that the changes are regularly stored in a power-independent manner (also known as "Copy RAM to ROM"). You can either save the setting for each individual commissioning step or save all the settings made and the tuning results at the end of the commissioning.

1. To save powerfail-proof, click  in the footer of the Web server.
A save prompt appears:

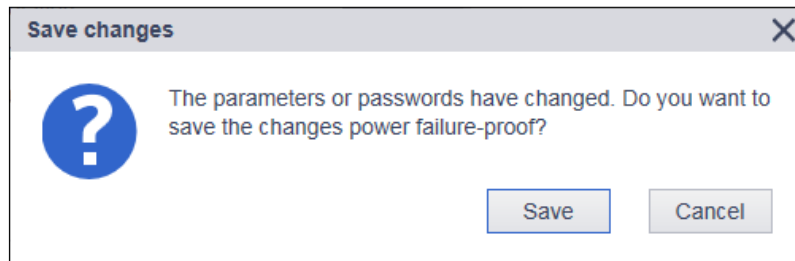

Figure 6-10 Permanent saving prompt

2. Click "Save" to save the data permanently.

Note:

Note

Operation with memory card

If a memory card is inserted in the converter, the settings are then not only saved powerfail-proof in the converter, but are also saved on the memory card. This allows you to easily replace the converter in a spare part scenario.

 [Replacing the converter with memory card \(Page 274\)](#)

6.2 Commissioning using the web server

Overview

After being switched on, the converter starts extensive self-configuration. The most important data is read from the electronic rating plate of the motor connected using the OCC cable and used for the self-configuration routine.

Refer to the following sequence diagram for additional commissioning steps.



Note

Rights required for commissioning

You must login as administrator, as administrator rights are required when commissioning the system.

 [User and access rights \(Page 179\)](#)

Requirements for commissioning

- The motor and converter have been installed according to data provided in the following Chapter.
 [Installing \(Page 139\)](#)
- The mechanical system is mounted onto the motor.
- The converter is connected to the commissioning device via the service interface (X127).
- You have assigned the administrator password.
 [Logging on for the first time and assigning an administrator password \(Page 183\)](#)

Commissioning sequence

Commissioning is carried out in the subsequently listed steps. The individual commissioning steps are optional, and can be carried out when required.

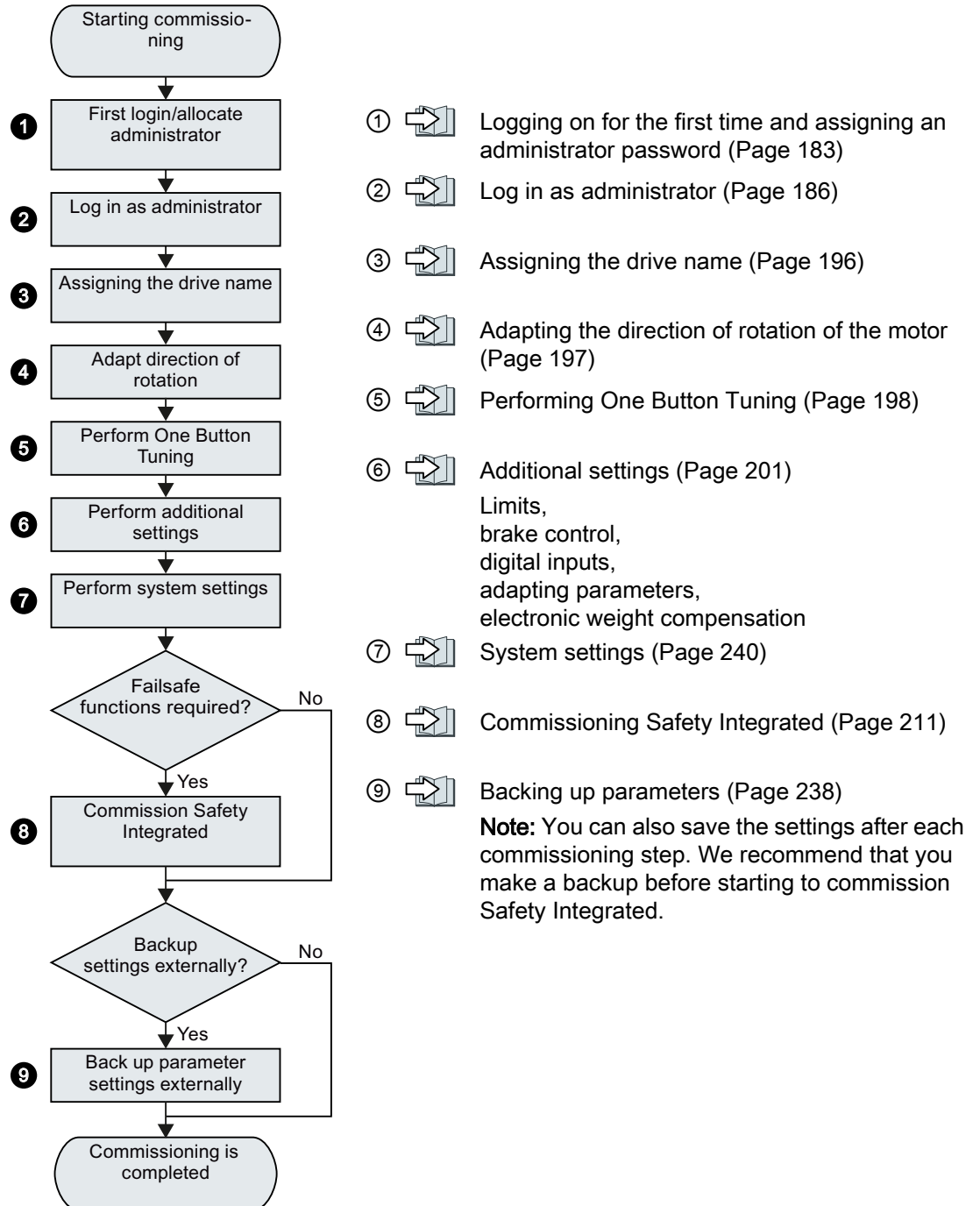

6.2.1 Assigning the drive name



During converter commissioning you can allocate a specific system name.

Procedure

1. Select "Commissioning > Device" in the navigation.

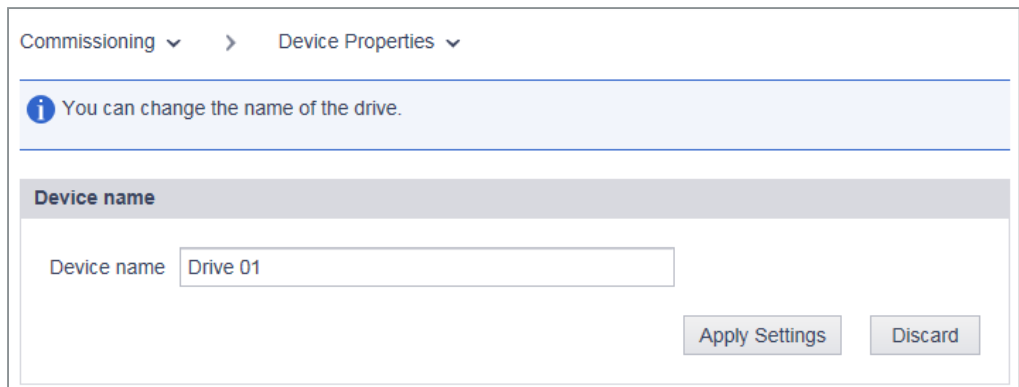



Figure 6-11 Device name

2. Enter a new drive name in the "Drive name" field.
Do not use special characters for the drive name. The name cannot be saved when special characters are used.
3. Click "Apply Settings" to save the changes in the RAM of the device.
The assigned drive name is displayed in the status bar of the web browser, on the overview page for the converter data and on the tab of the browser window.
4. Click  to save the data permanently.

You have assigned the drive name.



6.2.2 Adapting the direction of rotation of the motor



In the factory, the direction of rotation is set so that the motor rotates clockwise when you are looking at the motor shaft from the front.

If you enter a setpoint from the PLC, and the motor rotates with the incorrect direction of rotation, then you can change the direction of rotation as shown below.

Changing the direction of rotation of the motor via the web server

Procedure

1. Select "Commissioning > Device properties " in the navigation.
2. Change the direction of rotation in the dialog screen form.

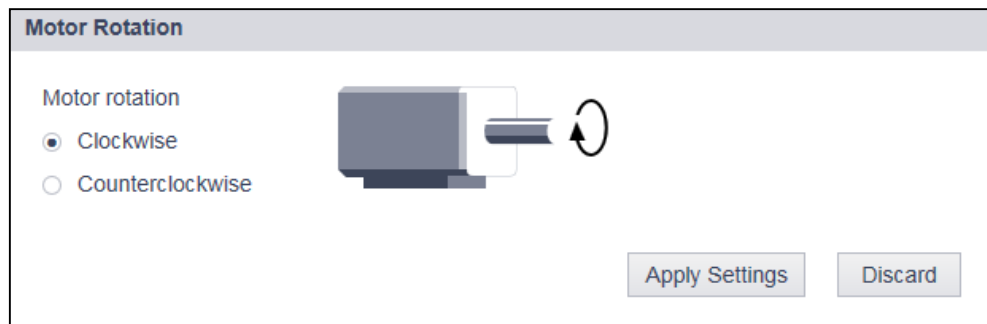

3. Apply the changes.
4. Check the new setting.
5. Save the setting using .



You have changed the motor direction of rotation.



Note

Entering the setpoint from the web server control panel

If you change the direction of rotation as described above, this does not influence the setpoint input from the web server control panel.

This means that you must enter a setpoint for clockwise rotation ( Hold to rotate) at the control panel, in order that the motor rotates counter-clockwise (.

6.2.3 Performing One Button Tuning



An important part of the basic commissioning is the "One Button Tuning" ("OBT"). The converter closed-loop control is optimally set using the One Button Tuning

Note

Both directions of rotation for One Button Tuning

Please note that when performing One Button Tuning the motor rotates in both directions.

If the application does not permit this, then it is not permissible that One Button Tuning is carried out.

Procedure

1. Select "Commissioning > Tuning" in the navigation.

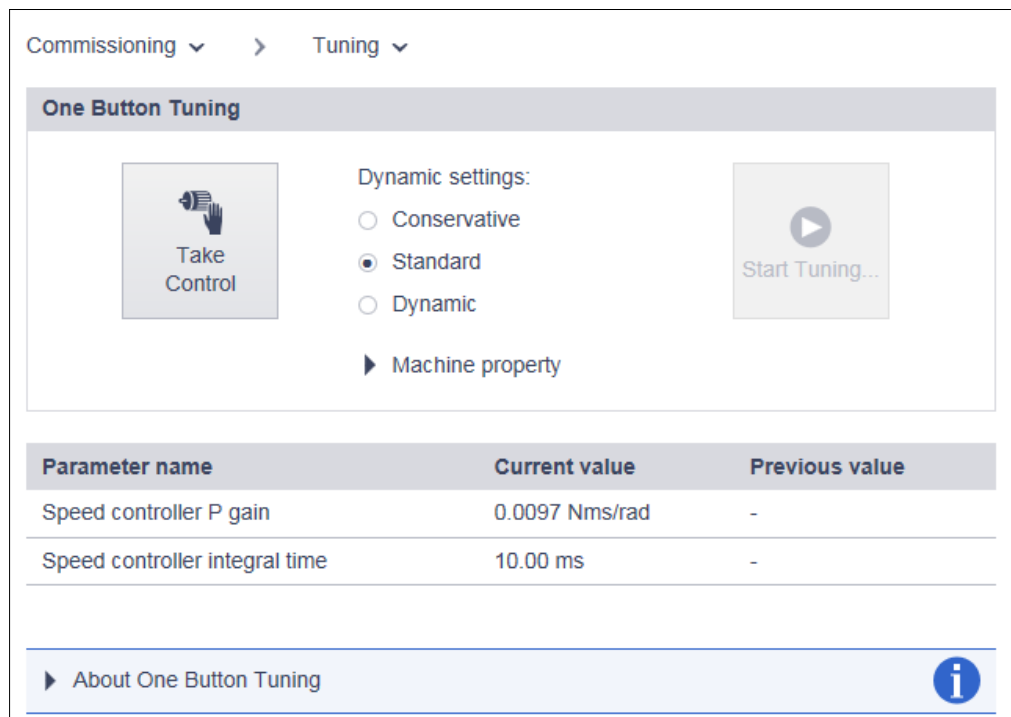

Figure 6-12 View before performing the One Button Tuning

2. Click "Take Control".
Confirm the safety prompt.
The master control is indicated by a broken orange bar.

3. Select the desired dynamic response setting for the One Button Tuning corresponding to the mechanical system of your machine.

One Button Tuning optimizes the drive based on the selected dynamic response setting.

- "Conservative":
60 % speed control dynamic performance without precontrol
- "Standard":
80 % speed control dynamic performance with torque precontrol
- "Dynamic":
100 % speed control dynamic performance with fast torque precontrol

You can activate the higher dynamic performance if your machine satisfies the conditions listed under "Machine property".

4. Click "Start Tuning...".

A prompt for the permissible angle of rotation (rotation limit) of the motor shaft appears.

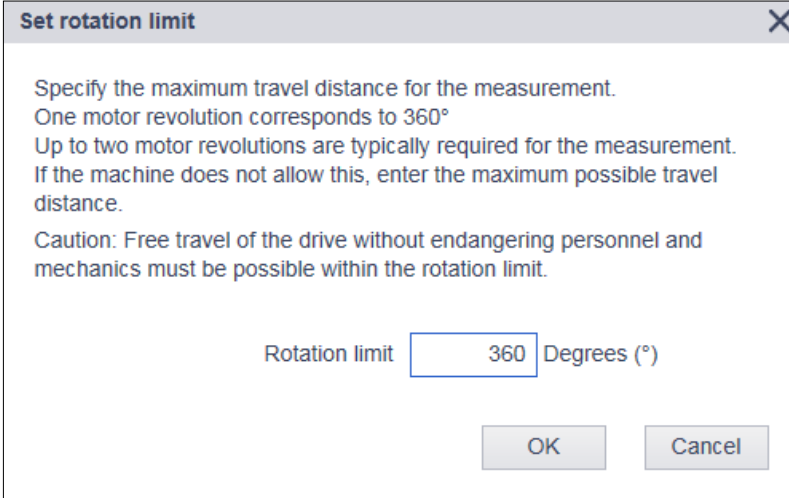

Set rotation limit

Specify the maximum travel distance for the measurement.
One motor revolution corresponds to 360°
Up to two motor revolutions are typically required for the measurement.
If the machine does not allow this, enter the maximum possible travel distance.
Caution: Free travel of the drive without endangering personnel and mechanics must be possible within the rotation limit.

Rotation limit Degrees (°)

OK Cancel

Figure 6-13 Rotation limit

5. Enter the angle through which the motor and the connected machine are permitted to turn for the required measurements (e.g. 360 °) without the mechanical system being damaged.

Note

If you enter a negative angle, then the motor moves in the opposite direction.

Generally, longer traversing distances result in better optimization results.

6.2 Commissioning using the web server

6. Click "OK".
The tuning through the One Button Tuning starts. No entries are possible during the tuning. After the tuning has been completed, a message appears as to whether the "One Button Tuning" was successful - or not. If the OBT was not successful, then optimization must be repeated, possibly with modified entries.

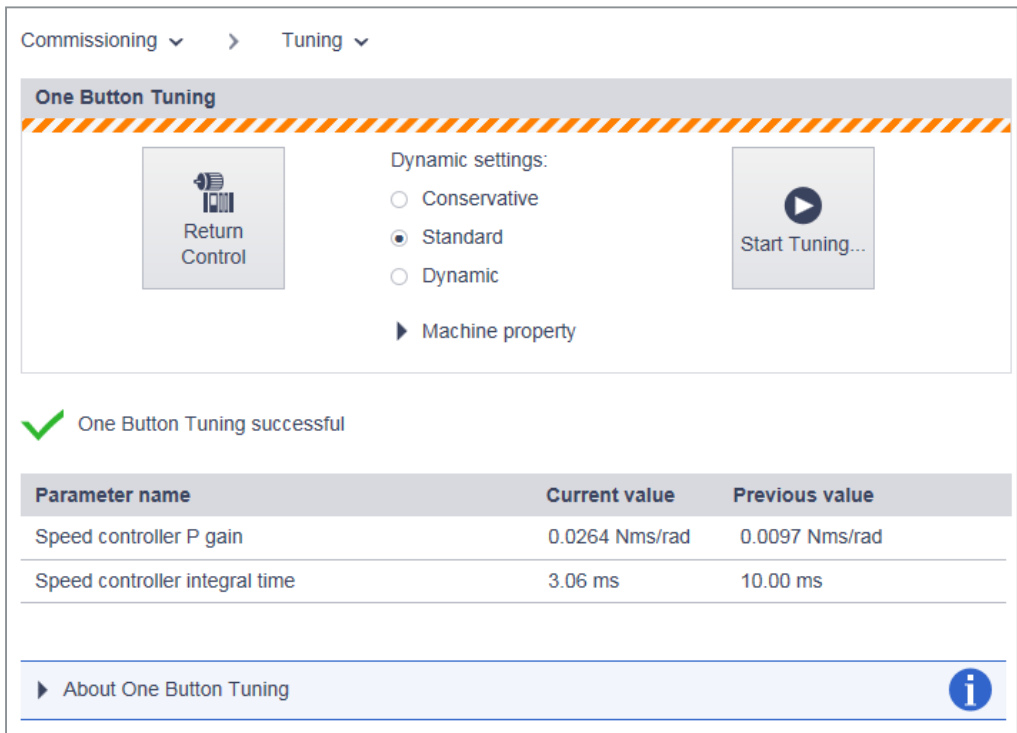



Figure 6-14 View after performing the One Button Tuning

A list in the lower part of the window shows how the settings have been changed by the One Button Tuning.

Note

If the machine vibrates or whistles at certain speeds following One Button Tuning, then the dynamic response setting is too high. In this case, select a lower dynamic response and repeat the One Button Tuning.

7. After you have optimized the controller, you must relinquish master control to the converter. Click "Return control".
8. Confirm the confirmation prompt with "Confirm".
The color bar is no longer displayed.
9. Click  to save the data permanently.

This means that you have executed One Button Tuning.

□

6.2.4

Setting limits



When required, you can configure limits for elements of your converter and adapt to the requirements of your mechanical system in the "Parameters - Limits" view.

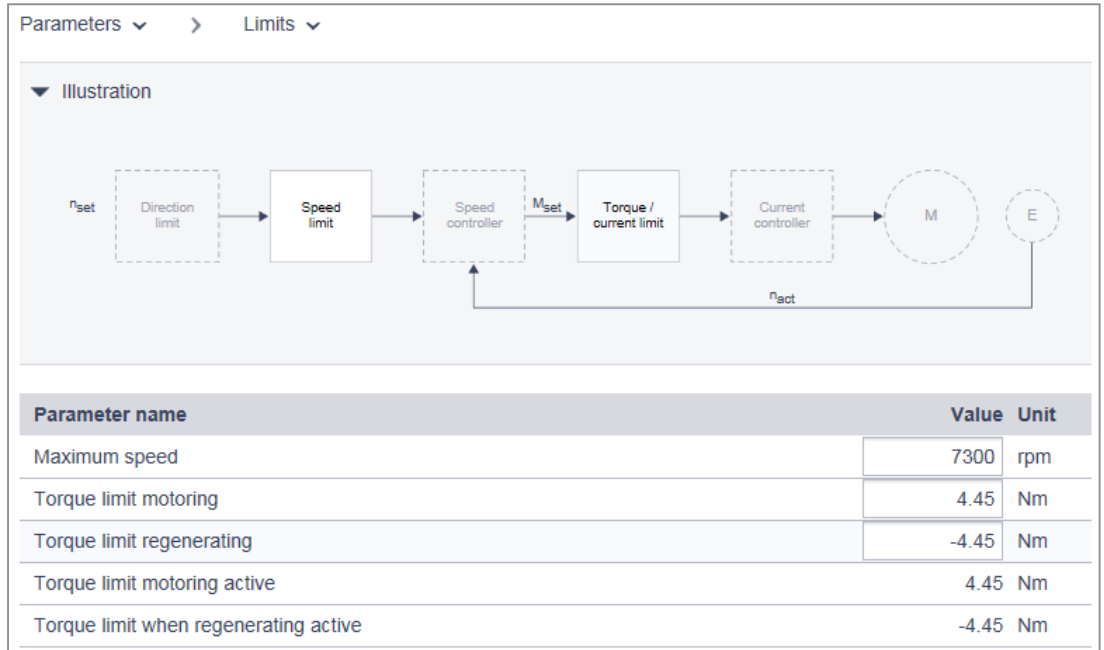



Figure 6-15 Parameters - Limits

Setting limits

1. Select "Parameters > Limits" in the navigation.
The table below the graphic shows the "Maximum speed" line of the speed limitation.
2. Enter the maximum speed in the input field of the same name.
3. Enter the two torque limit values.
 - "Torque limit, upper"
 - "Torque limit, lower"
4. Click  to save the data permanently.

6.2.5 Setting the brake control



The simple brake control is used exclusively for the control of holding brakes. The holding brake is used to secure drives against unwanted motion when deactivated.

Based on system-internal sequences, the converter checks and monitors the commands for opening and closing the holding brake and controls the output accordingly. The data required for the brake control is stored in the motor and only has to be corrected in exceptional circumstances.

More detailed information on the closing and opening times of the motor can be found in Chapter:

 Brake data (Page 295)

The start of the closing time for the brake depends on the end of the shorter of the two times "Standstill detection monitoring time" and "Pulse cancellation delay time".

Note

Automatic default setting

The values of the holding brake are automatically set correctly through the self-configuration of the converter in accordance with the electronic rating plate. As a consequence, generally the displayed values no longer have to be corrected.

The values in this screen form serve more as a check. It may only be necessary to adapt the values for suspended /vertical axes.

 Electronic weight counterbalance for a vertical axis (Page 210)

Procedure

1. Select "Parameters > Brake control" in the navigation.

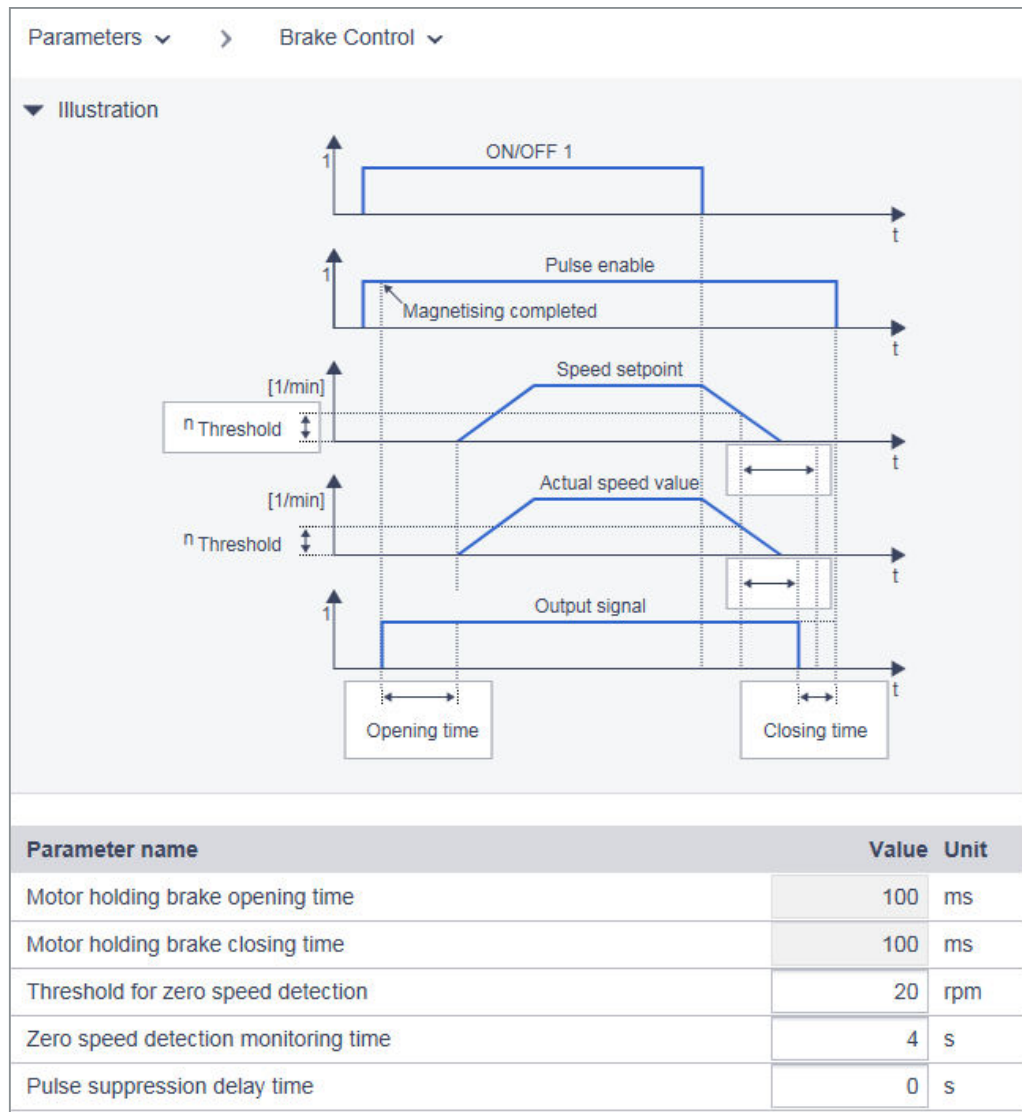



Figure 6-16 Brake control

2. If required, adapt the brake control values in the "Value" column:
 - "Standstill detection speed threshold"
 - "Standstill detection monitoring time"
 - "Pulse cancellation delay time"
3. Click  to save the data permanently.

6.2.6 Configuring digital inputs



In addition to the Failsafe Digital Input (F-DI, DI 2 and DI 3), the converter has two high-speed digital inputs (DI 0 and DI 1) as measuring inputs and for the evaluation in the controller.

If you use these digital inputs, you have to set a telegram in the controller that transfers the values, e.g. the PROFIdrive telegram 105.

The converter also has an input (DI 4) to monitor the temperature of an optional external braking resistor.

 Connection example (Page 174)

Setting digital inputs

1. Select "Parameters > Inputs" in the navigation.

Parameters > Inputs

i Specify the function of the digital inputs.

▼ Illustration

L+	•	▶	•	DI2+
DI0	•	▶	•	DI2-
M	•	▶	•	DI3+
L+	•	▶	•	DI3-
DI1	•	▶	•	L+
M	•	▶	•	DI4

X130

Terminal	Function
Digital Input 0 (X130/DI0)	No measuring sensor ▼
Digital Input 1 (X130/DI1)	No measuring sensor ▼
Digital Input 2, 3 (X130/DI2+, DI2-, DI3+, DI3-)	See Safety Integrated commissioning
Digital Input 4 (X130/DI4)	No function ▼

Figure 6-17 Digital inputs

2. Select the appropriate input signal in the table for the measuring inputs and the temperature control:
 - "Digital input 0 (X130/DI 0)": Measuring input 1
 - "Digital input 1 (X130/DI 1)": Measuring input 2
 - "Digital input 2, 3 (X130/DI 2+, DI 2-, DI 3+, DI 3-)":
 Failsafe Digital Input for the Safety Integrated Basic Functions "STO" or "SS1".
 The configuration is performed via the Safety commissioning. By clicking "Safety", you open the Safety commissioning and can make the appropriate settings there.
 "Commissioning Safety Integrated (Page 211)"
 - "Digital input 4 (X130/DI 4)": Temperature monitoring of ext. braking resistor
3. Click to save the data permanently.

6.2.7 Adapting parameters

You make most of the important converter settings in the dialog screen forms of the web server. In individual cases, it can be necessary to directly read out values from a parameter or enter these into a parameter.

The parameter list is used for this purpose, in which all device parameters are listed.

Select "Parameters > Parameter List" in the navigation to call up the parameter list.

This means, independent of previous settings, you always open the standard view of the parameter list.

The following sections describe how you can adapt the parameter list to address your specific requirements.

You will find a detailed description of the individual parameters and parameter types in the following Section:

 Parameters (Page 349)

6.2.7.1 Configuring the parameter list



To maintain the presentation of parameters as compact and transparent as possible, the web server displays the parameter list with all parameters in the simple view.

The manner in which you can display the details is described in the following sections.

Displaying the advanced list view

The parameter list is displayed in the simple view when called.

- To display the advanced view of the parameter list, click "Advanced view".
The "ID" and "My group" columns are now displayed to the left of the "Parameter" column.
The parameter ID simplifies the search for specific parameters.
You can create an individual list using "My Group", see "Grouping parameters"

Parameters > Parameter List

Search and Filters Reset all filters

Parameter Group: Commissioning
Parameter Types: Editable and read-only

My group	ID	Parameter	Value	Unit
<input type="checkbox"/>	p210	Drive unit line supply voltage	230	V
<input type="checkbox"/>	r302	motor code DRIVE-CLiQ	23754	
<input type="checkbox"/>	r304	Rated motor voltage	280	Vrms
<input type="checkbox"/>	r305	Rated motor current	2.95	Arms
<input type="checkbox"/>	r307	Rated motor power	1.11	kW
<input type="checkbox"/>	r311	Rated motor speed	2000.0	rpm
<input type="checkbox"/>	r322	Maximum motor speed	7200.0	rpm
<input type="checkbox"/>	r323	Maximum motor current	10.70	Arms
<input type="checkbox"/>	r550	Brake status	No data (0)	
<input type="checkbox"/>	r922	PROFIdrive PZD telegram selection	SIEMENS telegram 105, PZD-10/10 (105)	
<input type="checkbox"/>	p1082	Maximum speed	2517.091	rpm

Figure 6-18 Parameter list: Advanced view

This advanced list view is only temporary. The next time the web server is called, the simple view is displayed again.

Displaying parameter details

1. To display parameter details, click the  icon in front of the parameter name.

<input type="checkbox"/>	▼ p5271	One Button Tuning configuration 1	0001 1000 B	
<input type="checkbox"/>	▼ p5271[0]	One Button Tuning configuration 1	0001 1000 B	
	p5271[0].3	Speed precontrol	Yes	▼
	p5271[0].4	Torque precontrol	Yes	▼
	p5271[0].7	Voltage feedforward control	No	▼
<input type="checkbox"/>	r5274	One Button Tuning dynamic response estimated	0.00	ms

Figure 6-19 Example: Parameter details in the extended view

The parameter details are displayed. They are either:

- Values
- Index
- Bit array

An additional line is displayed in the table for each detail. This display is temporary. The parameter details are hidden again the next time the web server is called.

Grouping parameters

You can combine individual parameters of the parameter list into a personal group. You can activate the checkboxes in the "My group" column to assign the selected parameters to your personal group.

1. In the "My group" column, activate all checkboxes of the parameters that you want to take into your group.
2. Click  to save the data permanently.

6.2.7.2 Changing the parameter value



You can change the parameter values of the parameters that can be written to (p parameters) in the parameter list.

To do this, you have one of the following options:

1. Overwrite the current parameter value with the new value.
2. Select a value via the drop-down list.

Invalid values will be rejected.

Click  to save the data permanently.

6.2.7.3 Filtering the parameter list



You can set filters in the parameter list of the Web server and therefore limit the display of the parameters. You can make the filter settings via a filter bar above the parameter list. The filter settings can be combined.



Figure 6-20 Filter bar of the parameter list

Setting the filters of the parameter list

1. In the "Search" field, enter a search term (any number of characters) for which you want to search in the parameter list, e.g. "Current".
The search term is applied to the "ID" (only in the advanced view) and "Parameter" columns in the parameter list.
2. Select a group from the "Parameter Group" drop-down list.
 - All groups
 - My groups (configured by the user)
 - Specific groups, such as motor parameters
3. In the "Parameter Types" drop-down list, select whether adjustable parameters ("Editable"), display parameters ("Write protected") - or both are to be displayed in the parameter list.

The parameter list is limited further after every further filter setting (the filters are linked via an AND operation). The filters can be set in any order.

Note

Collapsing the filter bar

The filter bar is opened per default. To collapse the filter bar, click the ▼ arrow next to "Search and Filters".

Resetting filters

As long as you are logged in to the Web server and the filter settings have not changed, the parameter list is always displayed with the last filter settings. To reset all filter settings in the parameter list, proceed as follows:

Click "Reset all filters" at the top right in the filter bar.

6.2.8 Electronic weight counterbalance for a vertical axis



With a vertical axis without mechanical weight compensation, you can set an electronic weight compensation.

To do this, in "Parameter > Parameter list" select the corresponding parameter.

The required offset value is displayed in r0031 when the axis is at a standstill (smoothed torque actual value). Transfer this value in p1532 (torque limit, offset).

The torque limits (p1520 and p1521 - can also be set via "Parameter - Limits") are shifted by this offset.

Save the setting using .

To prevent the axis from dropping after the brake is released, you can specify the torque offset as an additional torque setpoint (M_ADD) via the supplementary telegram 750. As a result, the holding torque is specified when the brake is released.

Note

Due to the specified supplementary torque setpoint via the controller, a switchover of the supplementary torque is also possible. Thus, when the load is lifted, a supplementary torque can be specified that is different from the supplementary torque for movement without a load.

The supplementary telegram 750 must be configured in the PLC.

 Supplementary telegrams (Page 541)

6.3 Commissioning Safety Integrated

 WARNING**Unexpected movement of machines caused by inactive safety functions**

Inactive or non-adapted safety functions can trigger unexpected machine movements that may result in serious injury or death.

If a card without safety functions is inserted instead of a memory card with active safety functions, when the drive is switched on the next time, the safety functions are deactivated.

- Only insert a memory card with the required settings into the drive.
- Prevent unauthorized persons accessing the drive.
- Password-protect configurations with active safety functions against changes.

Note**Faulty safety functions in case of non-EMC-compliant installation**

A non-EMC-compliant installation of your machine/system can result in sporadic safety function faults.

- Install the drive so that it is in compliance with EMC regulations according to the specifications in Section:



EMC-compliant installation of a machine or system (Page 47)

6.3.1 Overview of Safety Integrated commissioning



The web server provides you with a commissioning Wizard that navigates you through all of the steps required during Safety commissioning.

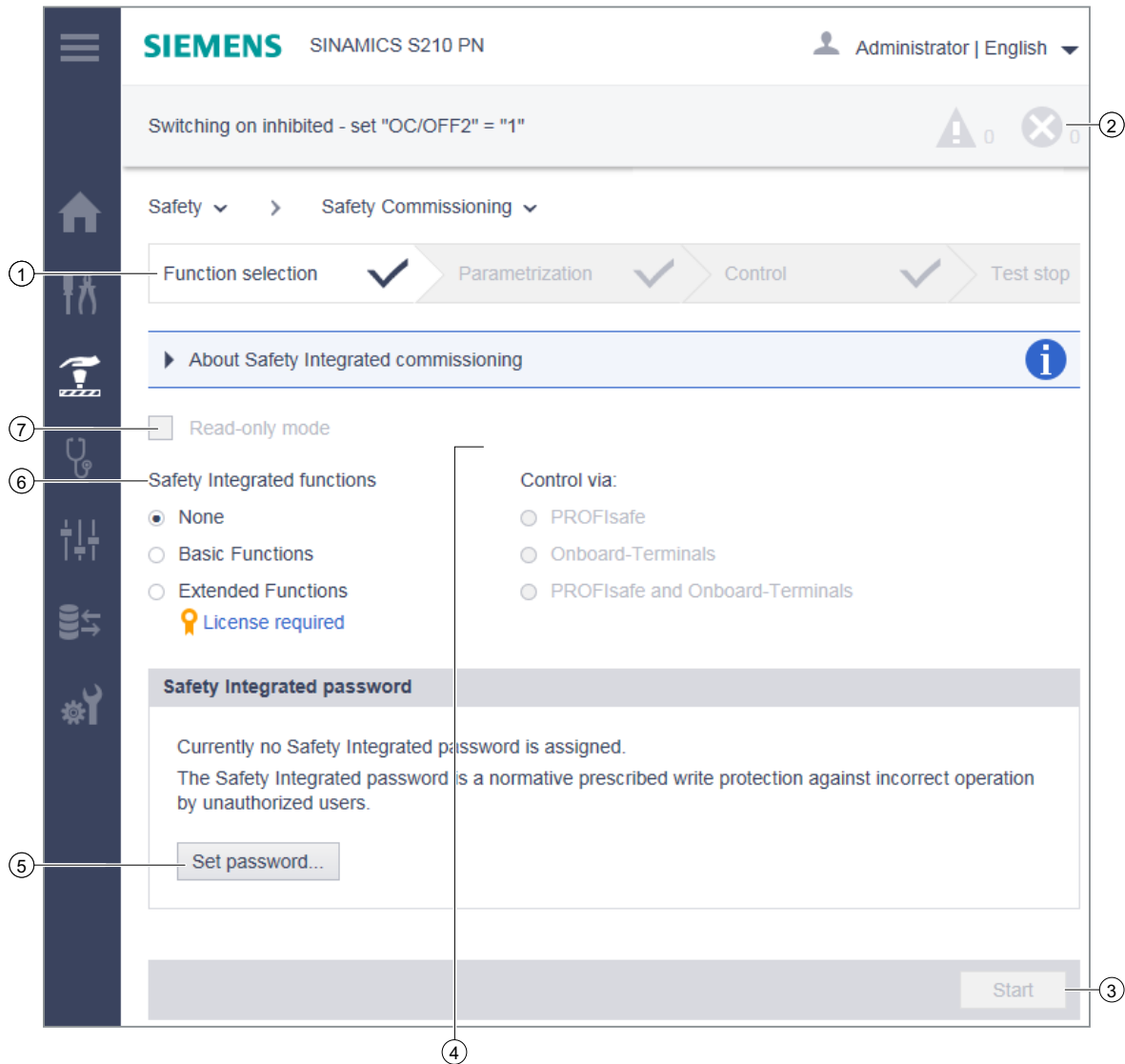

- ① Wizard with commissioning steps
- ② Access to faults and alarms (is only possible after the first commissioning has been completed)
- ③ Start and carry out Safety commissioning
- ④ Selection to control the Safety functions
- ⑤ Safety password
- ⑥ Selects the Safety functions
- ⑦ Activation of the read-only mode (prevents inadvertent changes)

Figure 6-21 Overview: Safety commissioning Wizard

Basic information on commissioning Safety in the web server

- Safety settings can only be made in the "Safety Integrated commissioning" mode. The drive is in a safe state (STO active) as long as the commissioning mode is active. The commissioning mode is activated in step "Function selection" using the "Start" button.
- You must completely run through the Safety commissioning. It is not possible to cancel commissioning.
- A password can be defined to protect against unauthorized changes to Safety settings. This can either be done at the beginning or at the end of the Safety commissioning. The drive issues an alarm if a password has not been defined.
- You can find faults and alarms for Safety Integrated in the general message window. It is not possible to access faults and alarms after you have started to commission Safety Integrated. In the web server you only see alarms such as A01698 as "gone".
- You can check the Safety settings that have been set in the read mode at a later point in time. This function is available to you – both as administrator or if you are logged into SINAMICS.

Displaying the Safety commissioning view

The individual commissioning steps are displayed in the header of the "Safety Commissioning" screen form.

Commissioning Safety Integrated in the web server is described in principle in the following.

1. Select "Safety > Safety Commissioning" in the navigation.

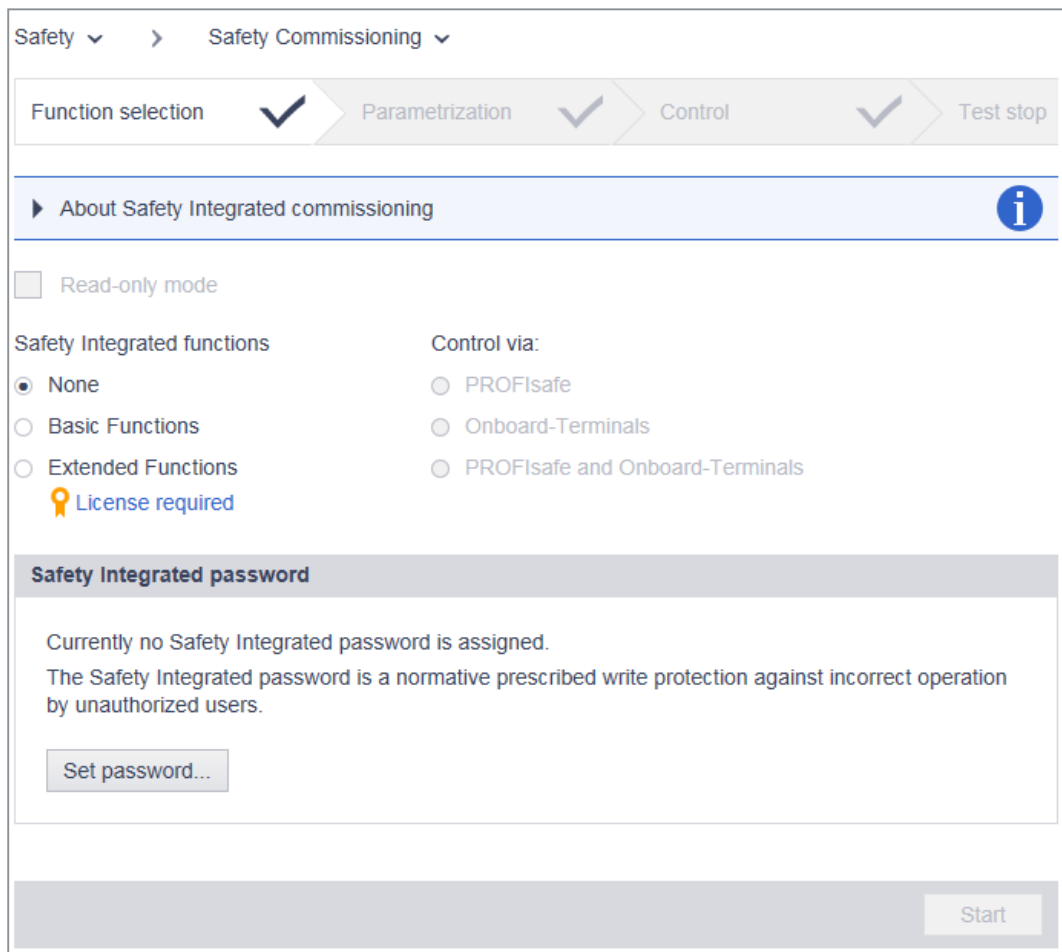



Figure 6-22 After calling

2. Safety settings are carried out step-by-step in the individual screen forms. A green checkmark indicates that a commissioning step has been completed.
3. Specify how you want to continue with the Safety commissioning. The following options are available for selection:
 -  Execute commissioning step-by-step (Page 216)
 -  Check commissioning in read-only mode (Page 227)

Icons in the header

- The commissioning steps marked with a checkmark do not require any compulsory entries.
- The commissioning steps marked with a red pen require entries.

Basic information on the safety functions

Detailed information on the safety functions used can be found in the following Chapter:

-  Safety functions integrated in the drive (Page 75)

6.3.2 Commissioning Safety Integrated

6.3.2.1 Overview

Proceed as follows to parameterize Safety Integrated Functions:

<ul style="list-style-type: none"> • Function selection (Page 216) 	
<ul style="list-style-type: none"> • Commissioning Basic Functions (Page 218) 	<ul style="list-style-type: none"> • Commissioning Extended Functions (Page 219)
<ul style="list-style-type: none"> • Control via PROFIsafe (Page 221) or • Controlling via onboard terminals (only Basic Functions) (Page 221) or • Control via PROFIsafe and onboard terminals (Page 222) 	<ul style="list-style-type: none"> • Control via PROFIsafe (Page 221) or • Control via PROFIsafe and onboard terminals (Page 222)
<ul style="list-style-type: none"> • Test stop (forced checking procedure) (Page 223) 	
<ul style="list-style-type: none"> • Finalizing commissioning (Page 225) 	
<ul style="list-style-type: none"> • Safety password (Page 226) 	

6.3.2.2 Function selection

Select the desired functions and the control method in the "Function selection".

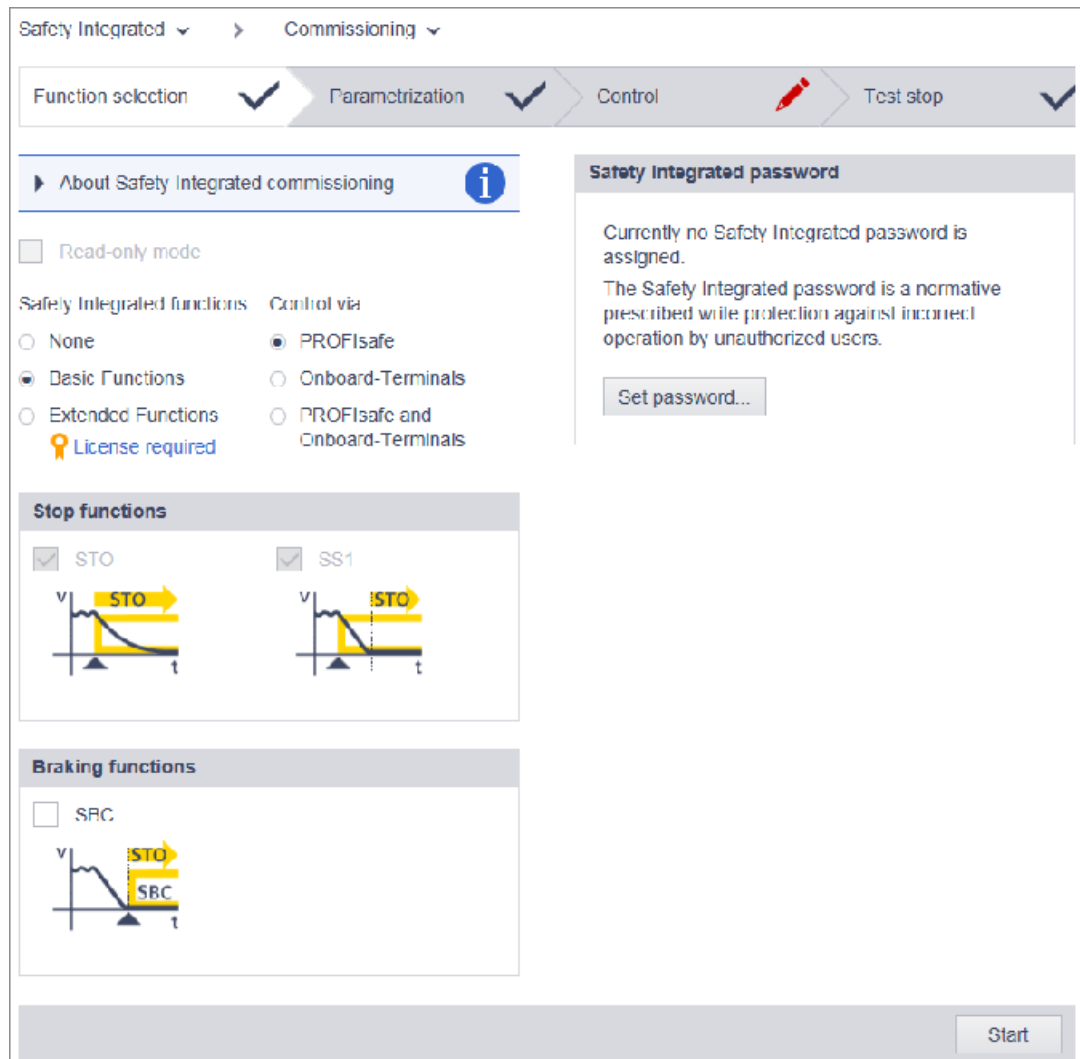



Figure 6-23 Defining function selection; example "Extended Functions"

1. Select the required Safety function group:
 - Basic Functions
 - Extended Functions, these functions require a license
 Functions that require a license (Page 74)
2. In addition to the preselected functions, select the additional functions that you require.

3. Also select how you wish to control the Safety functions:

- "PROFIsafe"
- "Onboard terminals" (only for Basic Functions)
- "PROFIsafe and onboard terminals"

You can select the functions independently of one another using the individual bits via PROFIsafe. Depending on the setting of parameter p9652 "SS1 delay time", select either SS1 or STO via the onboard F-DI.

4. Switching over the safety axis type

If you switch over the safety axis type from a linear axis to rotary axes (and vice versa), you must save the complete parameterization - and also carry out a warm restart of the converter. After the warm restart, safety faults F01680 and F30680 are active. This is because after the axis switchover, the units of a series of safety parameters will have changed, and in turn, the safety actual checksums.

- The converter saves all parameters once the axis switchover has been initiated.
- You must re-commission Safety Integrated to accept these actual checksums as new reference checksums.
- Acknowledge the safety faults using the standard acknowledgment.

5. Assign a Safety password. You can also define the Safety password later. The drive issues alarm A01637 as long as a Safety password is not defined.

 Safety password (Page 226)

6. If a Safety password has been defined, then you must enter the Safety password in order to make additional settings.
7. To start the configuration of the individual Safety commissioning steps, click "Start" in the footer of the screen form.

See also

Commissioning Extended Functions (Page 219)

6.3.2.3 Commissioning Basic Functions

Parameterizing Basic Functions

Adapt the required settings in the "Parameterization" tab.

The screenshot displays the 'Parameterization' tab of a web server interface. At the top, a progress bar shows four steps: 'Function selection' (checked), 'Parametrization' (checked), 'Control' (checked), and 'Test stop' (unchecked). A warning message indicates that the PROFIsafe control bit for SS1 is not evaluated for an SI SS1 delay time of 0 s. Below this, a diagram titled 'STO / SS1 - Illustration' shows a step function for 'SS1 selection' and a corresponding 'STO active' signal with a 'Delay time SS1 > STO active'. To the right, under 'Additional parameters', there is a table with the following data:

Parameter name	Value	Unit
SI SS1 drive-based braking response	SS1 with	
SI transition time F01611 to STO	0	ms
OFF3 ramp-down time	0	s
Maximum speed	7300	rpm

At the bottom, there is a table for 'Parameter name', 'Value', and 'Unit' with the following entries:

Parameter name	Value	Unit
SI SS1 delay time	1	s
SI enable safe brake control	Inhibit SBC	
SI Safety Information Channel status word S_ZSW1B: STO active	Yes	

'Back' and 'Continue' buttons are located at the bottom right of the interface.

Figure 6-24 Parameterizing Basic Functions

1. Parameterize the emergency stop function with the "SI SS1 delay time".
2. Using the drop-down list "SI SS1 drive based braking response" you determine whether SS1 should be operated with OFF3 or with an external stop.
3. If you have selected "Basic Functions":
 - Click "Continue".
 - The "Control" commissioning step is activated.

6.3.2.4 Commissioning Extended Functions

Parameterizing Extended Functions

All functions which you have selected are displayed in the lower section of the screen form:

Safety Integrated ▾ > Commissioning ▾

Function selection ✓ Parametrization ✓ Control ✎ Test stop

- ▶ 1. STO / SS1 / SBC (Safe Torque Off, Safe Stop 1, Safe Brake Control)
- ▶ 2. SS2 (Safe Stop 2)
- ▶ 3. SOS (Safe Operating Stop)
- ▶ 4. SLS (Safely-Limited Speed)
- ▶ 5. SDI (Safe Direction)
- ▶ 6. Actual value acquisition / mechanical system

Back Continue

Figure 6-25 Parameterizing Extended Functions

6.3 Commissioning Safety Integrated

1. Click on the functions to be parameterized in sequence; SLS shown here as an example:

▼ Illustration

▼ Additional parameters

Parameter name	Value	Unit
SI Motion SLS setpoint speed limiting	80	%
SI Motion SLS-specific stop response (SLS1)	SS1	
SI Motion SLS-specific stop response (SLS2)	SS1	
SI Motion SLS-specific stop response (SLS3)	SS1	
SI Motion SLS-specific stop response (SLS4)	SS1	
SI motion diagnostics velocity: Actual SLS speed limit	0	mm/min
SI Motion setpoint speed limit effective: Setpoint limiting positive	7300	
SI Motion setpoint speed limit effective: Setpoint limiting negative	-7300	
SI Motion setpoint speed limit effective: Setpoint limit absolute	7300	

Parameter name	Value	Unit
SI Motion enable safety functions: Enable transfer SLS limit value via PROFIsafe	Inhibit	
SI Motion SLS switchover/SOS delay time	100	ms
SI Motion SLS limit values: Limit value SLS1	2000	mm/min
SI Motion SLS limit values: Limit value SLS2	2000	mm/min
SI Motion SLS limit values: Limit value SLS3	2000	mm/min
SI Motion SLS limit values: Limit value SLS4	2000	mm/min
SI Motion drive-integrated status signals: SLS active	No	

Figure 6-26 Parameterizing SLS

2. Set the values for SLS according to your respective requirements.
3. Parameterize all of the selected functions and the "Actual value sensing / mechanical system" of your application.
4. When you have parameterized all functions, click on "Continue". The "Control" commissioning step is activated.

6.3.2.5 Commissioning the control

Control via PROFIsafe

The telegram and the address must be entered for control of the safety functions via PROFIsafe.

Figure 6-27 Parameterizing control via PROFIsafe

The PROFIsafe telegram, which was set in the device configuration for the S210 with the TIA Portal, is written by the F-PLC into the converter, and is displayed here as parameter r60022.

1. Select the required PROFIsafe telegram in the "PROFIsafe telegram" drop-down list.
2. Enter the PROFIsafe address. The PROFIsafe telegram and PROFIsafe address must match the definitions in the device configuration of the converter.
3. Click "Continue".
The "Test stop" commissioning step is activated.

Controlling via onboard terminals (only Basic Functions)

The Basic Functions (STO, SS1) can be controlled via onboard terminals.

The following connections are supported:

- P/M switching of F-DO external devices
- Current sourcing/sourcing F-DO of external devices
- Self-monitoring sensors (OSSD)
- Non-self-monitoring sensors (e.g. emergency stop button)

The existing modules of external devices operate with different test pulses for the on/off test.

6.3 Commissioning Safety Integrated

The debounce time is set in conjunction with the connected module. The debounce time specifies the duration of an interference pulse at the F-DIs, which does not change the state of the drive.

The signal states at the two terminals of an F-DI are monitored in order to determine whether these have assumed the same logical state within the discrepancy time (unavoidable time delay). The selection and deselection must be performed in both monitoring channels within this discrepancy time.

The discrepancy time and the debounce time are pre-assigned default values and do not have to be changed in most cases. See the following figure.

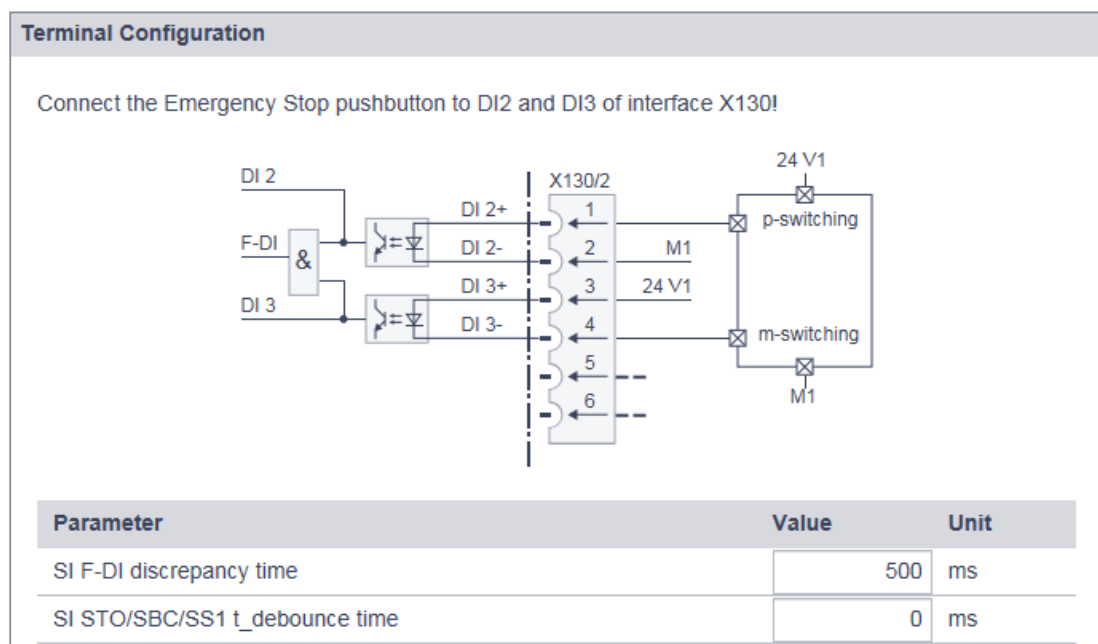

Figure 6-28 Parameterizing the controller via terminals

1. If you want to change the discrepancy time, click the "SI F-DI discrepancy time" field. An input dialog with the same name opens. Adjust the set discrepancy time and confirm with "OK".
2. If you want to change the debounce time, click the "SI STO/SS1 debounce time" field. An input dialog with the same name opens. Set the debounce time and confirm with "OK".
3. Click "Continue". The "Test stop" commissioning step is activated.

Control via PROFIsafe and onboard terminals

With this selection, you combine both possibilities:

- Control via PROFIsafe (Page 221)
- Controlling via onboard terminals (only Basic Functions) (Page 221)

6.3.2.6 Test stop (forced checking procedure)

Test stop (forced checking procedure)

To meet the requirements of the DIN EN ISO 13849-1 and IEC 61508 standards in terms of timely fault detection, the drive must test its safety-related circuits regularly - at least once a year - for correct functioning.

The "Test stop timer" exists for the test stop; by default, it is set to 8760 hours = 1 year. After this time, the drive signals that a test stop is necessary by issuing error message ("Acceptance test required"). The remaining time up to the test stop is determined automatically and displayed.

The test stop (forced checking procedure) for the Safety Integrated Basic Functions is performed by selecting STO and then deselecting it. As a consequence, the timer is reset and the active message acknowledged.

If a different time interval is required for the test stop (e.g. as the result of a risk analysis), change the interval as described in the following.

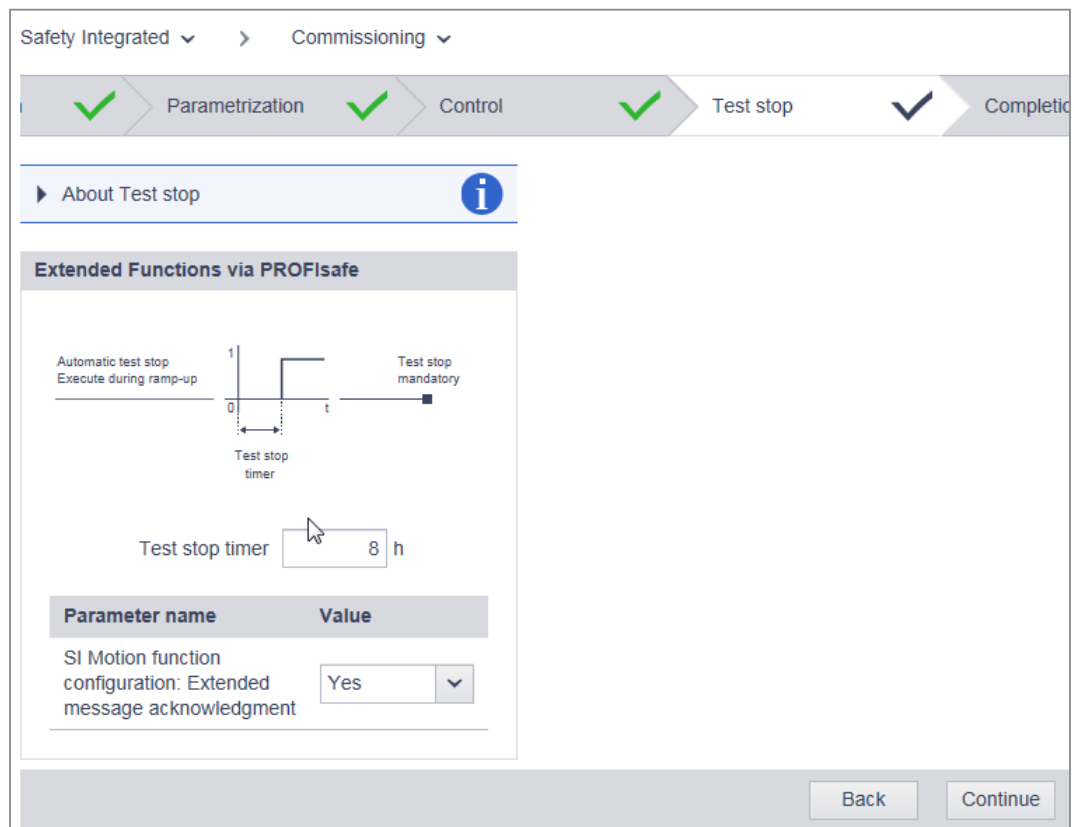

Figure 6-29 Configuring test stop (forced checking procedure)

1. To change the time interval, click in the "Timer test stop" field.
2. Set the time interval for the timer. Confirm with "OK".
The remaining time up to the test stop is determined automatically and displayed.

6.3 Commissioning Safety Integrated

3. For the Extended Functions, you can also select here whether you would like to use the "Extended message acknowledgment":
You may then also acknowledge safety messages of the Safety Integrated Extended Functions with selection/deselection of STO.
4. Click "Continue".
The "Completion" commissioning step is activated.

6.3.2.7 Acceptance test mode

Acceptance test mode

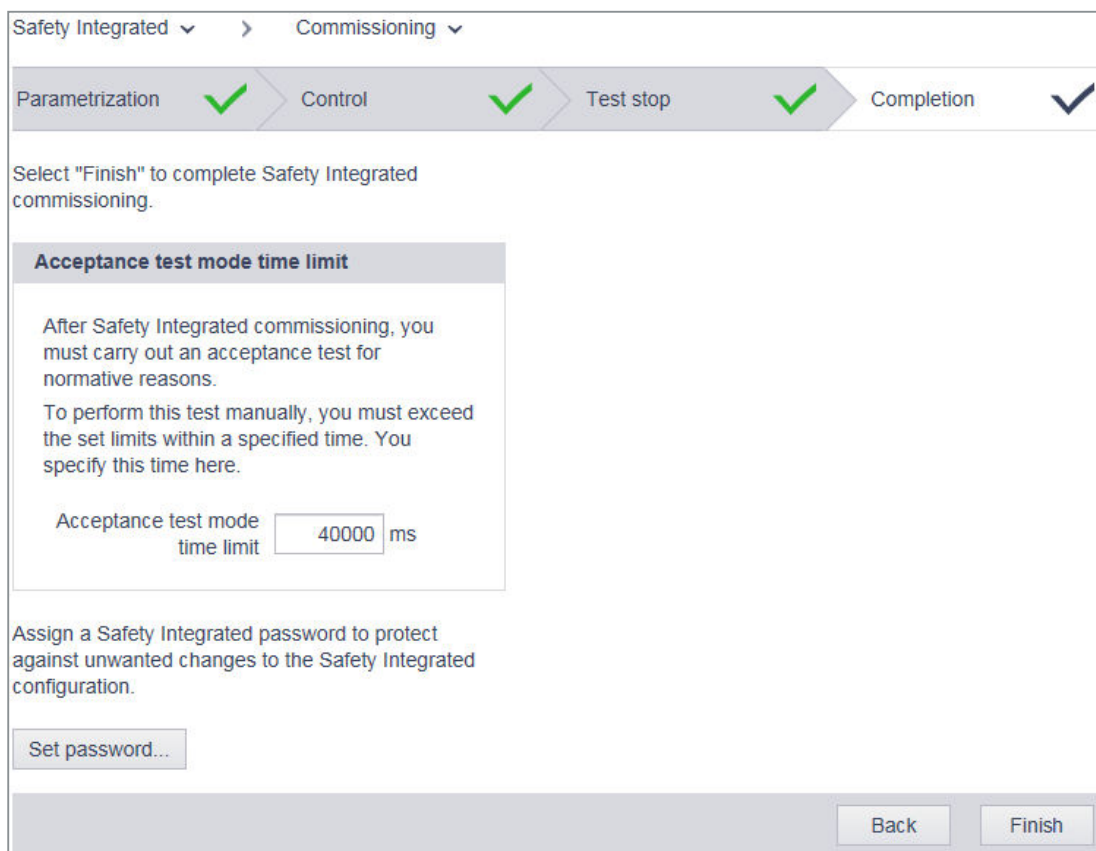

Figure 6-30 Acceptance test mode

The acceptance test mode can be activated for a parameterized time. Acceptance test mode tolerates specific limit value violations for the acceptance test. For instance, the setpoint speed limits are no longer active in the acceptance test mode. To ensure that this state is not accidentally kept, the acceptance test mode is automatically exited after the time set.

It only makes sense to activate the acceptance test mode during the acceptance test of the SS2, SOS, SDI and SLS functions. The acceptance test mode has no effect on other functions.

Normally, SOS can be selected directly or via SS2. To be able to trigger violation of the SOS standstill limits with acceptance test mode active (even in the "SS2 active" state), the setpoint is enabled again by the acceptance test mode after deceleration and transition to SOS to allow

the motor to travel. When an SOS violation is acknowledged in the active acceptance test mode, the current position is adopted as the new stop position so that an SOS violation is not immediately identified again.

6.3.2.8 Finalizing commissioning

Completion

You have made all of the settings for commissioning the drive-integrated Safety functions. If no Safety password has yet been configured, the password can be defined in this step (refer to following section).

1. Click "Finish".

The following prompt appears. Click "Finish" again to confirm the prompt.

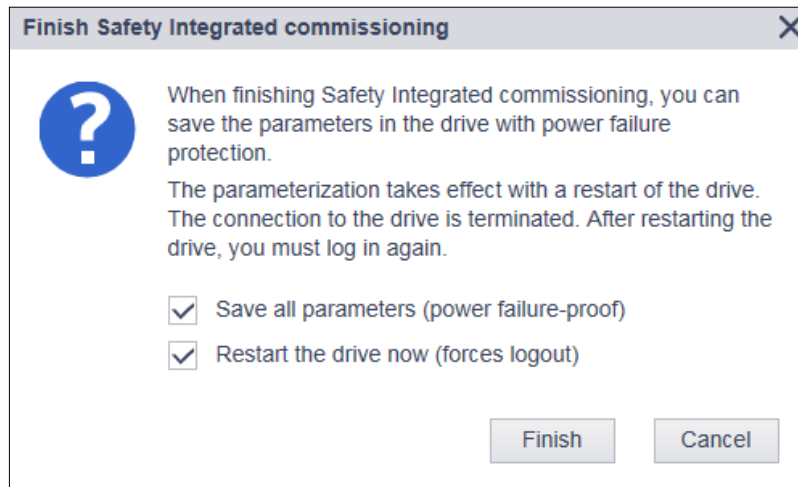

Figure 6-31 Completing Safety commissioning

2. Click "Finish":
3. If both options are set, the drive responds as follows:
 - The drive adopts the settings of Safety commissioning.
 - A restart is performed.

Following the restart, commissioning of the drive-integrated Safety functions is concluded. The browser displays the home page of the web server again.

6.3.2.9 Safety password



Using the Safety password you protect the settings of the safety functions integrated in the drive against changes made by unauthorized users.

You can assign the Safety password either before starting to commission the Safety functions or at the end. The drive issues an alarm as long as a password is not assigned.

Safety Integrated password

✓ The safety password is assigned.

Safety Integrated password [●●●●●●●]

Change password... Reset password...

Continue

Note

The Safety password is write protection specified in the appropriate standards to prevent against maloperation by unauthorized users.

The password must also include the following elements to provide better protection against unauthorized access, e.g. by unauthorized persons:

- At least 8 characters
- Uppercase and lowercase letters
- Numbers and special characters (e.g.: ?!%+ ...)

It is not permissible that the Safety password is used elsewhere.

Checking the password

The length of the password is checked by the drive. There is no check for uppercase and lowercase letters and special characters!

If you have not assigned a password, any user can make changes to the settings of the drive-integrated safety functions by selecting "Safety Integrated / Commissioning". We therefore recommend that you always assign a password.

6.3.3

Checking existing Safety settings in the read-only mode



If one of the drive-integrated safety functions is enabled (p9601 \neq 0), then check the performed settings in read-only mode. This allows you to run through the complete Safety commissioning step-by-step without being able to perform changes.

6.3 Commissioning Safety Integrated

The read-only mode is not available if you have not selected any Safety Integrated Functions.

1. Activate the "Read-only mode" option.

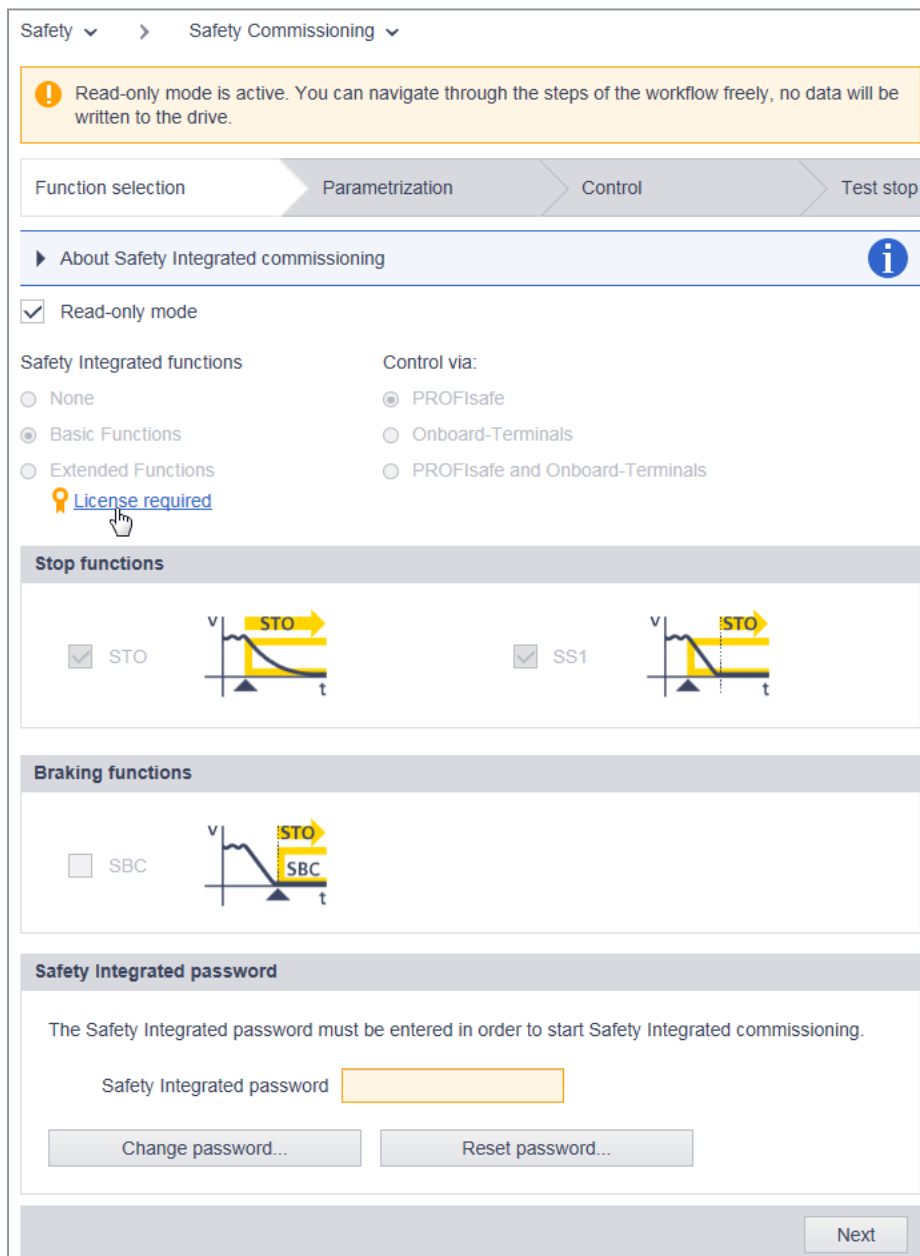

Figure 6-32 Safety commissioning in read-only mode

The individual commissioning steps are displayed in the header of the "Safety Commissioning" screen form.

2. Click the "Continue" button each time and check the values which you have set during Safety commissioning.

6.3.4 Changing Safety settings



In order to change Safety settings, you must run through all commissioning steps as with commissioning.

1. Select "Safety Integrated > Commissioning" in the navigation.
If you have set a Safety Integrated password, you must enter the password in order to access the Safety settings:

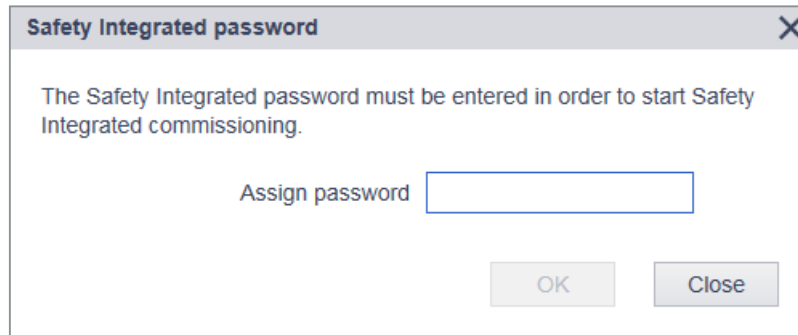

Figure 6-33 Safety password

6.3.5 Safety diagnostics



The most important information on the Safety settings and the states of the converter are displayed using the Safety diagnostics.

1. Select "Safety > Safety Diagnostics" in the navigation:

Safety Integrated > > Diagnostics

Status of Safety Integrated Functions

	Not active
	Not active
	Not active
	Not active
	Not active
	Not active
	Not active
	Not active
	Not active

Status

Test stop timer h

Time remaining until test stop h

No internal event

Safety Integrated Logbook

The Logbook helps detecting parameter changes.

Functional checksum

Checksum

Timestamp

Hardware-specific checksum

Checksum

Timestamp

Acceptance test mode

Here you can start the acceptance mode. The acceptance mode ends automatically after the time limit has expired. You can change the time limit during Safety Integrated commissioning.

Acceptance test mode time limit ms

You receive the following individual information via separate display areas:



- "Diagnostics of the Safety functions"
Shows which Safety functions have been activated in the converter.
- "Status"
Information on the status of the converter. If a test stop is required, then this is displayed. The times for the test stop of the timer and the remaining time up to the test stop are displayed.
The display area also shows whether internal events (e.g. software errors in the converter or a discrepancy in the monitoring channels) have taken place and whether the communication is OK.
- "Safety logbook"
The "Safety Logbook" function is used to detect changes to Safety parameters that affect the associated CRC sums. CRCs are only generated when p9601 (SI enable, functions integrated in the drive) is > 0.
Data changes are detected when the CRCs of the SI parameters change. Each SI parameter change that is to become active requires the reference CRC to be changed so that the drive can be operated without SI fault messages. In addition to functional Safety changes, Safety changes as a result of hardware being replaced can be detected when the CRC has changed.
Functional changes are recorded in the checksum r9781[0]:
 - Functional CRC of motion monitoring
 - Functional CRC of the drive-integrated basic safety functions
 - Enable drive-integrated functionsHardware-specific changes are recorded in the checksum r9781[1]:
 - Hardware-dependent CRC of motion monitoring
- "Acceptance test mode"
For further information, see Chapter "Acceptance test mode (Page 224)".

6.4 Diagnostic functions

6.4.1 Display messages



To call the list of messages, proceed as follows:

1. Select "Diagnostics > Messages" in the navigation.
- Or -
2. Click the  or  icon in the header of the web server.
The "Diagnostics - Messages" view appears with a message list. Further information about S210 messages can be found in Chapter "Faults and alarms (Page 419)".

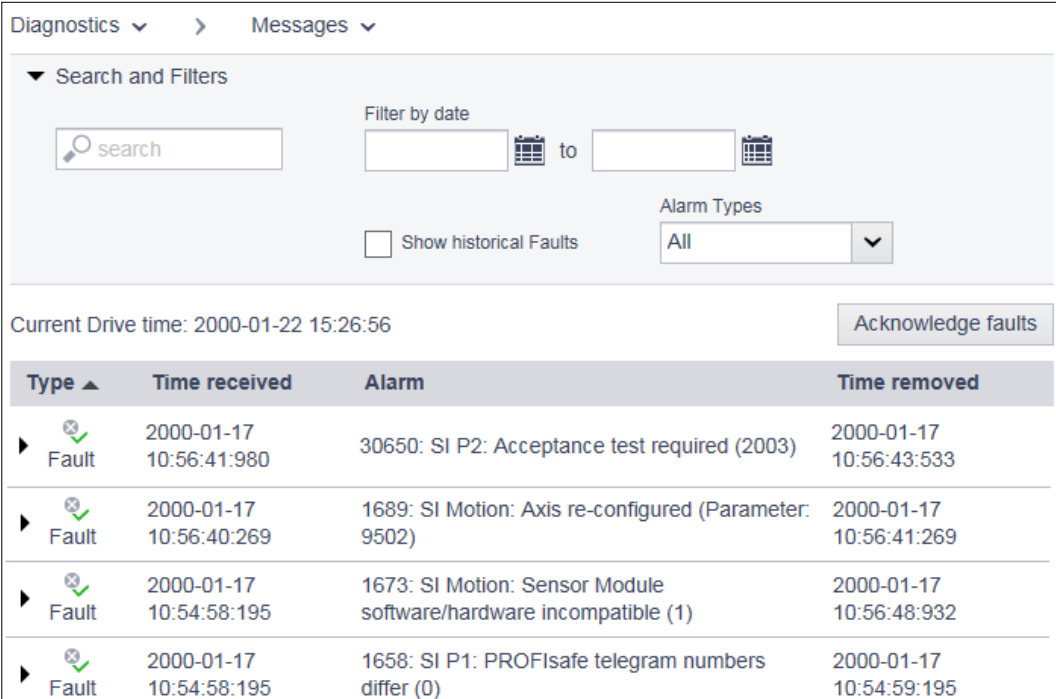







Type ▲	Time received	Alarm	Time removed
 Fault	2000-01-17 10:56:41:980	30650: SI P2: Acceptance test required (2003)	2000-01-17 10:56:43:533
 Fault	2000-01-17 10:56:40:269	1689: SI Motion: Axis re-configured (Parameter: 9502)	2000-01-17 10:56:41:269
 Fault	2000-01-17 10:54:58:195	1673: SI Motion: Sensor Module software/hardware incompatible (1)	2000-01-17 10:56:48:932
 Fault	2000-01-17 10:54:58:195	1658: SI P1: PROFIsafe telegram numbers differ (0)	2000-01-17 10:54:59:195

Figure 6-34 Message list

Explanation of the icons:

-  Alarm
-  Fault
-  OK (acknowledged fault)

6.4.1.1 Filtering messages



You can set filters in the message list of the Web server and therefore limit the display of the messages. You can make the filter settings via a filter bar above the message list. All filters are linked by an AND connection.

The screenshot shows a filter bar with the following elements:

- A dropdown menu labeled "Search and Filters" with a downward arrow.
- A search input field with a magnifying glass icon and the text "search".
- A "Filter by date" section with two date input fields: "2001-07-10" and "2001-07-26", separated by a "to" label and calendar icons.
- A checkbox labeled "Show historical Faults" which is currently unchecked.
- An "Alarm Types" dropdown menu currently showing "All".
- A "Reset all filters" button with a downward arrow icon in the top right corner.

Figure 6-35 Filter bar of the message list

Setting filters

1. In the "Search" field, enter a search term (any number of characters) for which you want to search in the message list.
The search term is also active in the "Alarm" column in the message list.
2. In the two "Filter by Date" fields, enter a period for which the messages are to be displayed.
The message list is limited further after every filter setting. The filters can be set in any order.

Note

Collapsing the filter bar

The filter bar is opened per default. To collapse the filter bar, click the ▼ arrow next to "Search and Filters".

Resetting filters

As long as you are logged in to the Web server and the filter settings have not changed, the message list is always displayed with the last filter settings. To reset all filter settings in the message list, proceed as follows:

Click "Reset all filters" at the top right in the filter bar.

The message list then displays the unfiltered view of the messages again.

6.4.2 Display drive status

Select "Diagnostics > Drive status" to display the converter state in the web server.

You will receive more detailed information if you click on the point of the arrow (▶).

For conditions where the drop-down list is not grayed out, a graphic representation is shown in the detailed view.

The graphic representation has the advantage that, in addition to the actual values, also the limits are displayed.

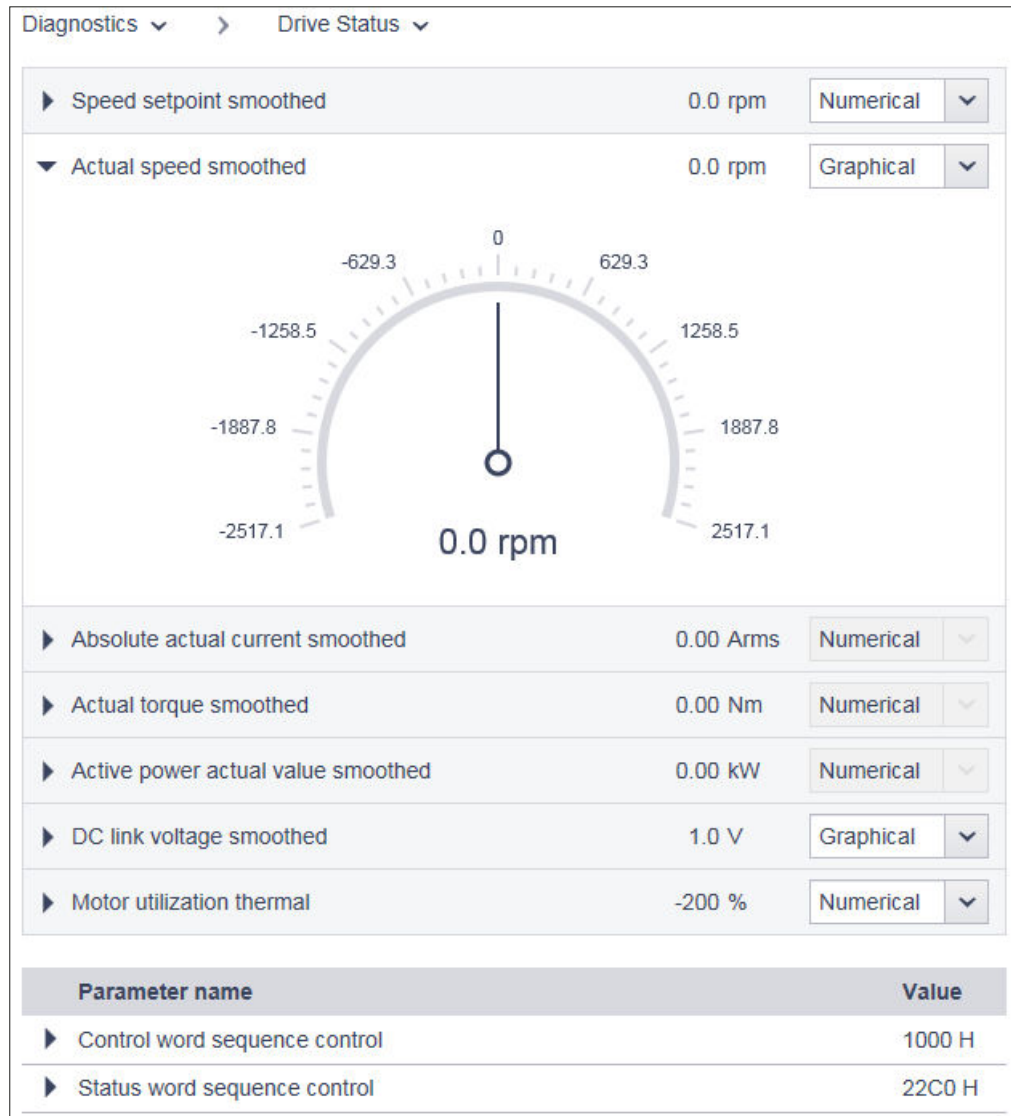

Figure 6-36 Example, drive status

The settings are not saved. The window is displayed in the basic setting if you log out and then log in again.

6.4.3 Displaying communication settings



Proceed as follows to display the communication settings:

Select "Diagnostics > Communication" in the navigation.

The web server shows a window with the following contents:

- IP address of the converter
- Name of the station
- Information as to whether the connection between the controller and the converter is active
- The standard telegram
 - Table with process data for the transfer direction "controller > converter"
 - Table with process data for the transfer direction "converter > controller"

Diagnostics ▾ > Communication ▾

PROFINET IP of Station 192.168.0.12

PROFINET Name of Station sinamics-s210-pnxb1979d

Cyclic connection diagnostics ✔ Connected

PROFIdrive PZD telegram selection SIEMENS telegram 105, PZD-10/10

Direction: Controller > Drive

PZD	Content	Description	Value	
1	STW 1	Control word 1	0400	hex
2 3	NSOLL	Setpoint speed	0000_0000	hex
4	STW 2	Control word 2	1000	hex
5	MOMRED	Torque reduction	0000	hex
6	G1 STW	Encoder control word	0000	hex
7 8	XERR	Control deviation	0000_0000	hex
9 10	KPC	Position control gain	0000_0000	hex

Direction: Drive > Controller

PZD	Content	Description	Value	
1	ZSW 1	Status word 1	03C8	hex
2 3	NIST	Actual speed	0002_0E07	hex
4	ZSW 2	Status word 2	4010	hex
5	MELDW	Message word	01CF	hex
6	G1 ZSW	Encoder status word	0000	hex
7 8	G1 XIST1	Cyclic actual value (incremental encoder)	0000_01AC	hex
9 10	G1 XIST2	Absolute actual value (absolute encoder)	0000_0000	hex

Figure 6-37 Communication settings

6.4 Diagnostic functions

The values are displayed in hexadecimal format in the default setting. You can switch the display of individual values between binary and hex format by clicking on the button to the right of the value.

6.5 Backup and restore

Using the following screen form, select the functions for backing up and restoring. Select "Backup and Restore" in the navigation.

Backup & Restore ▾

Parameter Backup

i Save the parameter settings in a file after the commissioning.
After a device replacement or a series commissioning, write these parameter settings of this file to the drive with "Restore parameters via file".

Back up parameters

Restore Parameters From File

i In the case of a device replacement or a series commissioning, download your own parameter backup to the drive.

Select file

Restore Factory Settings

i By resetting to the factory settings, all parameters of the drive are reset to the factory settings. If a motor is connected, it will be configured automatically.
After resetting, we recommend that you load a valid parameter backup or re-commission the drive (if necessary: optimization, set safety functions).

Restore Factory Settings

Figure 6-38 Backing up and restoring data

6.5.1 Backing up parameters



You can back up the converter settings externally using the web server.

You can perform the data backup at any time. We recommend a data backup after the commissioning of the converter.

1. Save the settings in a non-volatile fashion using .
Click "Back up parameters" in the "Parameter Backup" setting area.
The data backup of the parameters is performed. A message is displayed when the data backup is successful.
Depending on the browser used, a storage dialog appears in which you can specify where the backup file is to be saved.
In some browsers, e.g. Google Chrome, the file is stored in the standard directory for downloads as "Backup.zip".
2. Correct the automatically generated name of the data backup so that the required data backup can be uniquely identified by the name.

Note

Checking and editing externally saved parameters

The data are saved in a format that cannot be edited – further, they cannot be checked or modified.

6.5.2

Restoring externally backed-up parameter settings



If you load the externally backed-up parameter settings to the converter again, you restore the converter state to the time of the data backup. You can also use the externally backed-up files for a series commissioning.

1. Click "Browse" in the "Restore Parameters From File" setting area.
2. Select the data backup file in your file system.
The data backup file is now displayed in the view.
3. Click "Restore" in the "Restore Parameters From File" setting area.
The data backup is loaded. The converter is then restarted. You must log in to the Web server again.
4. Log in to the Web server again.

6.5.3

Restoring factory settings



The motor must be connected in order to restore the factory settings using the web server.

Procedure:

1. In "Backup and Restore", click on "Restore Factory Settings".
2. Acknowledge the confirmation prompt. The converter is reset, and then restarted.
If both LEDs are lit green, then the reset has been completed.

You have reset the converter to the factory settings and carried out the basic motor commissioning.



Additional options for restoring the factory settings is provided in the following Section:



Reset converter/password - restore the state when originally delivered (Page 270)

6.6 System settings in the web server

6.6.1 Settings

6.6.1.1 Setting or changing user accounts



For SINAMICS S210, both user accounts - "SINAMICS" and "Administrator" - are permanently defined, and cannot be changed by users.

You can make the following settings in the user accounts:

- Changing the Administrator password
- Authorize or inhibit "SINAMICS" user
- Defining a new password for the "SINAMICS" user
- Changing/deleting the password for the "SINAMICS" user

Password requirements

To protect against unauthorized access, by an attacker, for example, generate a secure password that consists of:

- At least 8 characters
- Uppercase and lowercase letters
- Numbers and special characters (e.g.: ?!%+ ...)
- Different passwords for different types of access (administrator / user)

Checking the password

The length of the password is checked by the converter. There is no check for uppercase and lowercase letters and special characters!

Remember the passwords or store the passwords in a safe place that cannot be accessed by unauthorized persons.

Changing the password



Figure 6-39 Changing the password

Perform the following steps to configure the user accounts for the web server:

Changing the Administrator password

The "Administrator" cannot be deactivated.

Procedure

1. Select "System > Settings" in the navigation.
2. Select the "User Accounts" tab.
3. To change the Administrator password, click "Change password..." at the "Administrator" user.
A password dialog opens.
4. Enter the old password.
5. Enter a new password.
6. Enter the new password again.
7. Confirm the password change with "Change".
The dialog closes.
8. Click  to save the data permanently.

You have changed the password of the administrator.

□

Defining a new password for the "SINAMICS" user

Procedure

1. Select "System > Settings" in the navigation.
2. Select the "User Accounts" tab.
3. Activate the "Enable SINAMICS user" option.
4. Click "Define password..." at the "SINAMICS" user.
A password dialog opens.

6.6 System settings in the web server

5. Enter a new password.
6. Enter the new password again.
7. Confirm the password input with "OK".
The dialog closes.
8. Click  to save the data permanently.

You have redefined the password for the "SINAMICS" user.



Changing/deleting the password for the "SINAMICS" user

Procedure

1. Select "System > Settings" in the navigation.
2. Select the "User Accounts" tab.
3. If you want to change the password of the "SINAMICS" user, proceed as for the Administrator password (see "Changing the Administrator password").
- Or -
4. If you want to delete the password of the "SINAMICS" user, click "Delete password...".
A prompt appears.
Enter the old password and click "Delete".
5. Click  to save the data permanently.

You have changed/deleted the password for the "SINAMICS" user.



6.6.1.2 Configuring the IP connection



The X127 and X150 interfaces have the following defaults:

- Service interface (X127)
Access to the web server via the service interface is always active. Communication is performed in the factory setting via an HTTP connection.

NOTICE

Software manipulation when using non-encrypted connections (HTTP)

The HTTP protocol transfers data without encryption. This facilitates password theft, for example, and can lead to data manipulation by unauthorized parties and thus ultimately to damage.

- Limit access to HTTPS connections so that all data is transferred encrypted.

- PROFINET interface (X150)
Access to the web server via the PROFINET interface is deactivated by default. Communication via the PROFINET interface is always performed via the secure HTTPS connection.

Note

Security measures for communication via PROFINET interface X150

In accordance with the Defense in Depth concept, the PROFINET interface must be isolated from the remaining plant network (see Industrial Security (Page 24)).

Protection must be provided against access to the cables and possible open connections, for example, by installing in a control cabinet.

You can make the connection between the converter and the commissioning device more secure through the settings described in the following.

Procedure

1. Select "System > Settings" in the navigation.
2. Select the "IP Connections and Addresses" tab.

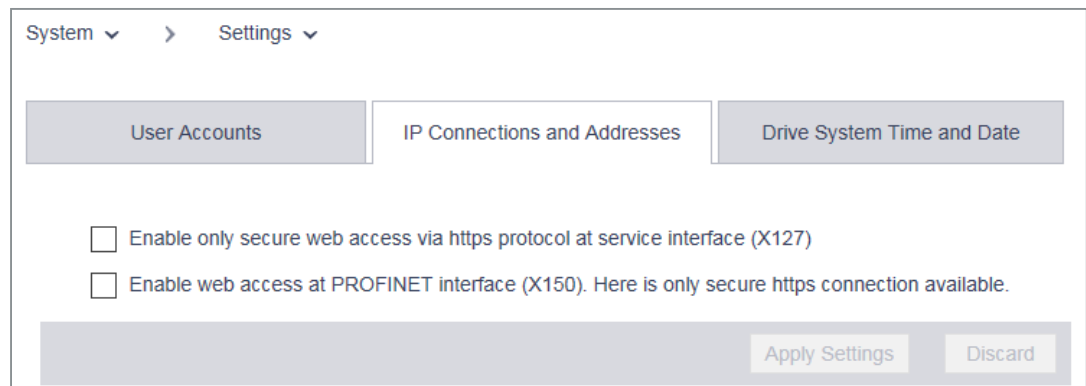



Figure 6-40 IP connections

3. Activate the desired connection options.

6.6 System settings in the web server

4. Click "Apply Settings" to save the changes in the RAM of the device.
5. Click  to save the data permanently.

You have configured the IP connection.



Note

Switchover from HTTP to HTTPS

If you were logged-in via HTTP, then after activating option "Only use HTTPS connection", you will be logged-out. To log in again, you must set a secure HTTPS connection (https://...) to the converter.

Note

Certificates for the secure data transfer

To secure an HTTPS connection, it requires security certificates for the encryption of the access. Detailed information on working with these security certificates can be found in Chapter "Certificates for the secure data transfer (Page 554)".

6.6.1.3 Configuring the system time



Per default, an NTP time synchronization (NTP = Network Time Protocol) is activated for the system time of the converter. The converter then synchronizes its system time with a central NTP server in the PROFINET network.

A library for use as SNTP server is available for the SIMATIC controllers. You will find these on the Support pages:



Library for the SNTP server functionality in SIMATIC S7 CPUs (<https://support.industry.siemens.com/cs/ww/en/view/82203451>)

If you want to deactivate this time synchronization or activate it again, proceed as follows:

1. Select "System > Settings" in the navigation.
2. Select the "Drive date and time" tab.

Figure 6-41 System time

3. Deactivate/activate "Activate NTP time synchronization".
4. Select the time zone (for Central Europe UTC+01:00) – only possible if NTP time synchronization has been activated.
5. Click "Apply Settings" to save the changes in the RAM of the device.
6. Click  to save the data permanently.

6.6.2 Updating the firmware via the web server

Carefully ensure that when upgrading, the converter settings are kept. For a downgrade, the converter is reset to the factory settings.

You can find the firmware versions available at the following link:



Firmware versions (<https://support.industry.siemens.com/cs/ww/en/view/109744577>)

Requirements

You have saved the zip file with the firmware to a drive, which you can access using the commissioning device.

The firmware can be updated from version 5.2 and higher.

Procedure

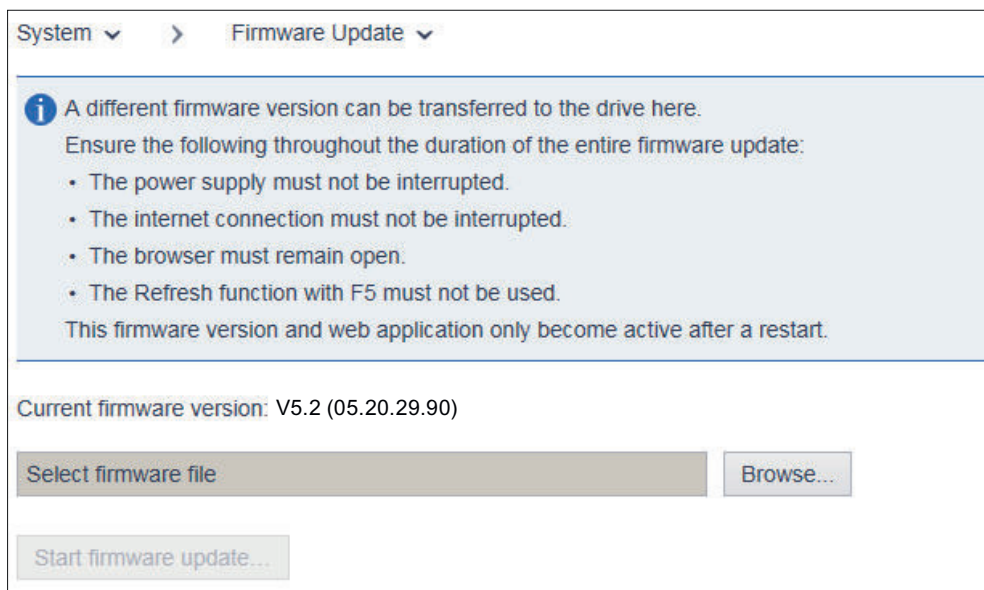

1. Select "System > Firmware update" in the navigation.



2. Select the zip file with the firmware version that you wish to load to the converter
3. Start the firmware update.
4. The new firmware is installed – this can take up to five minutes or longer. The update is completed when both LEDs are flashing red at 1 Hz in sync with each other.

RDY	COM	Explanation of the LED displays
		Firmware update is active <ul style="list-style-type: none"> • Do not switch off the power supply. • Do not disconnect the motor from the converter.
		LEDs are flashing synchronously: Converter waits until the power supply is switched off and switched on again after a firmware update.

5. Switch the converter off and on again. The firmware of the connected DRIVE-CLiQ components is updated. This may require a restart (see alarm messages in the web server).

RDY	Explanation of the LED displays
	Firmware update in progress for the connected DRIVE-CLiQ components. <ul style="list-style-type: none"> • Do not switch off the power supply. • Do not disconnect the motor from the converter.
	DRIVE-CLiQ component firmware update has been completed. Waiting for POWER ON of the corresponding components. Remedy: Switch the component off and on again.

6. Check whether the new version is installed. The firmware version of the converter is displayed on the home page of the web server under the converter.

6.6.3 Using functions that require a license

To display the license status, in the navigation, select "System > Licenses".

Using this page, also enter a license key that you purchased through the Web License Manager.

If you still do not have a license - however, you wish to set up and test functions that require a license, then you have the option of activating the Trial License Mode. Details are provided in the following section.

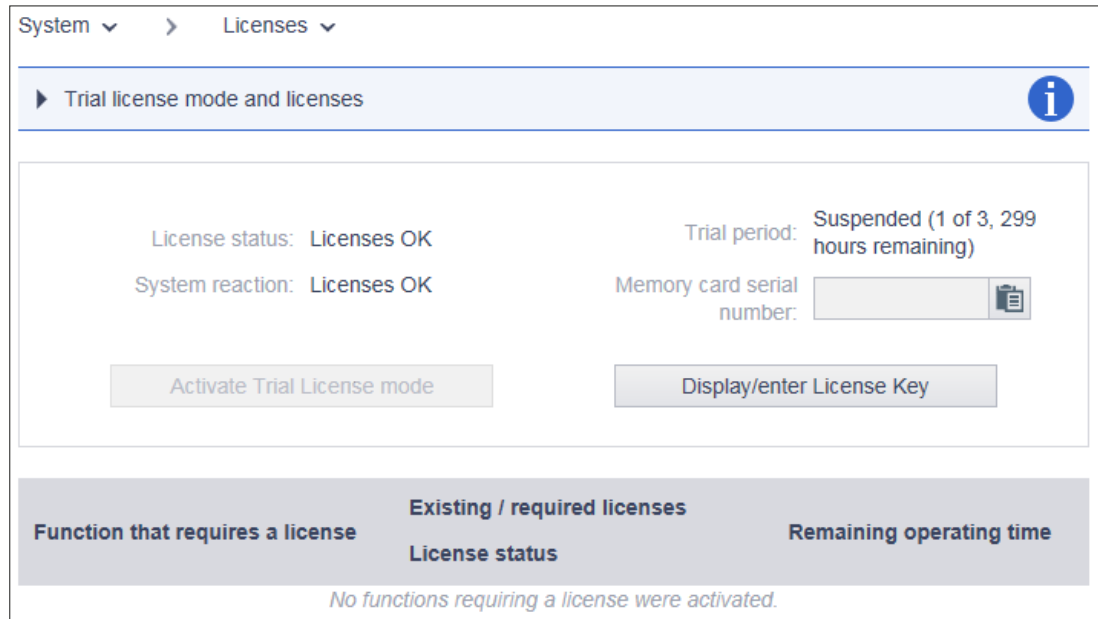

System reactions if there is a not a sufficient license

A license that is not completely sufficient is displayed as follows:

If there is no license - and a Trial License Mode has not been activated

- At the converter
 - Displayed when the RDY-LED flashes red with a frequency of 2 Hz.



- Display using the fault display with F18
- Via the web server
 - Fault F13000, "Licensing is insufficient"
 - System > Licenses

System > Licenses

▶ Trial license mode and licenses i

! No licenses! The drive will enter a fault state at the next ON command and is not ready for operation.

License status: Underlicensed

System reaction: Restart blocked

Trial period: Trial License mode not active

Memory card serial number:

Activate Trial License mode

Display/enter License Key

Function that requires a license	Existing / required licenses		Remaining operating time
	License status		
SINAMICS Safety Integrated Extended Functions More information	! 0 of 1	! No license	None

If there is no license - however, a Trial License Mode has been activated

- At the converter
 - Displayed when the RDY-LED flashes red/green with a frequency of 2 Hz.



- Via the web server
 - Message A13030 "Trial License activated"
 - System > Licenses

The screenshot shows the 'Licenses' page in the web server. At the top, there are navigation tabs for 'System' and 'Licenses'. Below this is a section titled 'Trial license mode and licenses' with an information icon. The main content area displays the following information:

- License status: Trial License mode activated
- System reaction: License warning active
- Trial period: 1 of 3, 299 hours remaining
- Memory card serial number: [input field]

There are two buttons: 'Activate Trial License mode' and 'Display/enter License Key'. Below this is a table with the following data:

Function that requires a license	Existing / required licenses	License status	Remaining operating time
SINAMICS Safety Integrated Extended Functions More information	✓ 0 of 1	🕒 Trial license	299 hours

Note

Operation without an adequate license is only permissible when commissioning the drive and when carrying out service work. To do this, activate the Trial License Mode

The drive requires a sufficient license in order for it to operate.

Trial License

There is a common Trial License Mode for most functions requiring a license. Using the Trial License Mode, you can try out these functions until you actually purchase the licenses.

The Trial License Mode encompasses three periods, each with 300 operating hours of the drive. You must separately start each period of the Trial License Mode.

If the last period of the Trial License Mode has elapsed, the drive goes into a fault condition the next time that it is switched on. To be able to switch on the drive again, you must either activate the functions that require a license - or you must enter a valid license key.

Use the Trial License

Procedure:

1. Select "System > Licenses" in the navigation.
2. Click "Activate Trial License Mode".
3. Acknowledge the confirmation prompt

Message A13030 indicates that the Trial License has been activated.



After the Trial License has expired, alarm A13031 "Trial License Period expired" is output.

Repeat steps 1 and 3 if you want to activate the Trial License for another trial period.

License key

You can view the current license key on the license overview page of the web server and enter a new key as required.

1. Select "System > Licenses" in the navigation.
2. In the license overview page, click on "Display/enter license key".
The current license key of your drive is visible in the upper field of the following dialog (if already present).
3. To use a new license key, enter it in the "New License Key" field (example: E1MQ-4BEA).
This allows you to replace a Trial License with a full license.
4. Click on "Activate" to activate the license key that has just been entered.
The dialog closes. The new license key becomes active the next time that the system runs-up.

Series commissioning

Overview

If you require the same settings for several machines - same application, same converter and same motor - then you have the option of carrying out a series commissioning routine.

For series commissioning, the settings of a converter can be transferred to any number of additional converters.

Note

PROFINET IP address and PROFINET device name are not transferred. You must configure the PROFINET IP address and the PROFINET device names in the PLC.

The converter takes the settings from the PLC.

There are two options when carrying out series commissioning of the converter:



- Series commissioning with memory card
All settings on the memory card – including the administrator password – are transferred to the converter.
- Series commissioning using the web server
All settings from the parameter backup – including the administrator password – are transferred to the converter.

When performing series commissioning, also observe the fundamental procedures when working with the web sever:

 Fundamentals (Page 178)

Series commissioning with memory card

Procedure

1. Insert an empty SD card with a maximum capacity of 2 GB (e.g.: 6SL3054-4AG00-2AA0) into the card slot of the converter that has been switched off
2. Switch on the converter and commission it.
 Commissioning using the web server (Page 194)
3. When commissioning has been completed, save the settings via .
This not only saves the settings in a non-volatile fashion in the converter – but also to the memory card.
4. Switch off the converter and remove the memory card from the converter.
5. Insert the memory card into the next - switched off - converter.

6. Switch on the converter and wait until it has run up - the RDY LED lights green.
When running up, the converter takes the settings from the memory card - including the administrator password.
7. Switch off the converter and remove the memory card from the converter.



Repeat steps 5 ... 7 for all converters to which you want to transfer these settings.

With this you have carried out a series commissioning for several converters using a memory card.

□

Series commissioning using the web server

Procedure

1. Switch on the converter and commission it.
 Commissioning using the web server (Page 194)
2. Save the settings at the end of commissioning via  .
3. Select "Backup and Restore" in the navigation - and back up the parameter settings in a file using "Back up parameters".
4. Connect your commissioning device with the next converter
5. Switch on the converter and assign an administrator password
6. In the navigation, select "Backup and Restore" - and load the parameter settings using "Restore parameters via file" to the converter.
The converter retrieves the parameters - including the administrator password - from the backup and restarts.

Repeat steps 4 ... 6 for all converters to which you want to transfer these settings.

With this you have carried out a series commissioning for several converters via the web server.

□

Diagnostics

8.1 Status displays and operating elements on the converter

The status of the converter is displayed via the three-digit display as well as by the "RDY" and "COM" LEDs.

Status display via the three-digit display

Normally, the display is dark.

Faults are shown according to the message classes defined in PROFIdrive. If PROFIdrive diagnostics is active, then they are simultaneously transferred to the control system.

Detailed information about alarms and faults is provided by the Web server of the converter.

 Diagnostic functions (Page 232)

Status display via LEDs

The converter displays the current operating state via two LEDs.

- RDY: converter state
- COM: communication state

During ramp-up, the LEDs assume different states.

The converter is ready for operation when the "RDY" LED is permanently green.

The LEDs always operate independently of one another, except when updating the firmware.

OK button



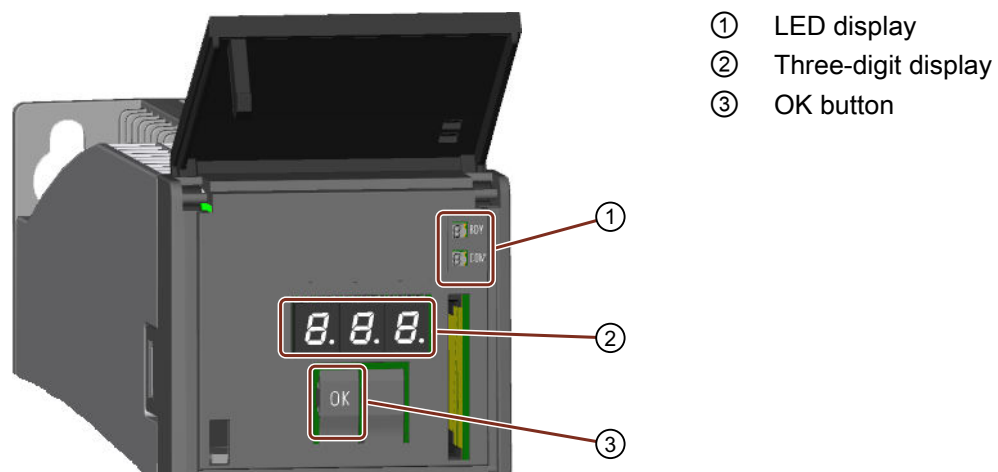

You can acknowledge the faults whose cause has been corrected with the OK button.



Display and operating elements on the converter



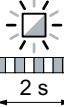





8.1.1 Status display via LEDs

Table 8-1 Explanation of symbols for the following tables

	LED is ON
	LED is OFF
	LED flashes slowly
	LED flashes quickly
	LED flashes with variable frequency

Please contact Technical Support for LED states that are not described in the following.

Table 8-2 Status explanation of the RDY LED

RDY	Explanation
	The electronics power supply is missing or outside the permissible tolerance range. Remedy: Check the power supply.
	Temporary status after the supply voltage is switched on.
	The device is ready for operation. Cyclic DRIVE-CLiQ communication is in progress.
	Writing to the memory card
	Commissioning or reset to factory settings
	PROFenergy energy-saving mode is active. Switch-on/off ratio: On: 0.5 s Off: 3 s
	Active fault or missing license Remedy: <ul style="list-style-type: none"> • Check the converter settings/configuration. • Activate the required license
	Firmware update is active
	Converter waits until the power supply is switched off and switched on again after a firmware update

8.1 Status displays and operating elements on the converter











RDY	Explanation
	Firmware update in progress for the connected DRIVE-CLiQ components. <ul style="list-style-type: none"> Do not switch off the power supply. Do not disconnect the motor from the converter.
	DRIVE-CLiQ component firmware update has been completed. Waiting for POWER ON of the corresponding components. Remedy: Switch the component off and on again.
 or 	CU detection via DCP flashing. Remark: Both options depend on the LED status when activating via DCP.
	Missing license: There is no license, however, the Trial License Mode has been activated.

Table 8-3 Status explanation of the COM LED

COM	Explanation
	No bus fault is present. When the RDY LED lights up green and the COM LED is off, the converter is ready for communication.
	Temporary status after the supply voltage is switched on.
	Bus ok. cyclic communication running perfectly
	<ul style="list-style-type: none"> Bus ok, however no setpoints (PLC in stop) In the isochronous mode: Bus ok, no synchronization
	No bus connection Remedy: Make sure that the bus cables are connected and are not damaged.
	Bus error, possible causes: <ul style="list-style-type: none"> Incorrect configuration in the PLC (the same supplementary telegram has been set twice?)

8.2 Message classes in accordance with PROFIdrive

The message classes according to PROFIdrive are shown in the converter display.

Example: Message class 4: F04

Message class	PN ¹⁾ (hex)	Explanation of the message class according to PROFIdrive - cause and remedy.
1	9000	Hardware fault/software error A hardware or software malfunction has been identified. <ul style="list-style-type: none"> • Carry out a POWER ON for the relevant component. • If it occurs again, replace again.
2	9001	Line fault A line supply fault has occurred (phase failure, voltage level, etc.). <ul style="list-style-type: none"> • Check the line supply/fuses • Check the supply voltage. • Check the wiring.
3	9002	Supply voltage fault An electronics power supply fault (24 V) has been identified. Check the wiring. <ul style="list-style-type: none"> • Check the voltage level.
4	9003	DC link overvoltage The DC-link voltage has assumed an inadmissibly high value. <ul style="list-style-type: none"> • Check the dimensioning of the system (line supply, reactor, voltages). • Check the infeed settings.
5	9004	Power electronics fault An inadmissible operating state of the power electronics has been identified (overcurrent, overtemperature, IGBT failure,...). <ul style="list-style-type: none"> • Check compliance with the permissible load cycles. • Check the ambient temperatures (fan).
6	9005	Electronic component overload The temperature in the component has exceeded the highest permissible limit. <ul style="list-style-type: none"> • Check the ambient temperature / control cabinet ventilation.
7	9006	Ground fault / inter-phase short-circuit detected A ground fault / inter-phase short-circuit has been identified in the power cables or in the motor windings. <ul style="list-style-type: none"> • Check the power cables (connection). • Check the motor.
8	9007	Motor overload The motor was operated outside the permissible limits (temperature, current, torque...). <ul style="list-style-type: none"> • Check the load cycles and set limits. • Check the ambient temperature / motor cooling.

Message class	PN ¹⁾ (hex)	Explanation of the message class according to PROFIdrive - cause and remedy.
9	9008	<p>Communication error to the higher-level controller</p> <p>The communication to the higher-level controller is faulted or interrupted. Check the state of the higher-level controller.</p> <ul style="list-style-type: none"> • Check the communication connection/wiring. • Check the bus configuration / clock cycles.
10	9009	<p>Safety monitoring channel has identified an error</p> <p>A safe operation monitoring function has detected an error.</p>
11	900A	<p>Actual position value / actual speed value incorrect or not available</p> <p>An illegal signal state has been detected while evaluating the encoder signals (track signals, zero marks, absolute values...).</p> <ul style="list-style-type: none"> • Check the encoder / state of the encoder signals. • Observe the maximum permissible frequencies.
12	900B	<p>Internal (DRIVE-CLiQ) communication error</p> <p>The internal communication between the SINAMICS components is faulted or interrupted. Check the DRIVE-CLiQ wiring.</p> <ul style="list-style-type: none"> • Ensure an EMC-compliant design.
13	900C	<p>Infeed fault</p> <p>The infeed is faulted or has failed.</p> <ul style="list-style-type: none"> • Check the infeed and its environment (line supply, filters, reactors, fuses...). • Check the infeed control.
14	900D	<p>Braking controller / Braking Module faulted</p> <p>The internal or external Braking Module is faulted or overloaded (temperature).</p> <ul style="list-style-type: none"> • Check the connection/state of the Braking Module. • Comply with the permissible number of braking operations and their duration.
15	900E	<p>Line filter faulted</p> <p>The line filter monitoring has identified an excessively high temperature or other inadmissible state.</p> <ul style="list-style-type: none"> • Check the temperature / temperature monitoring. • Check the configuration to ensure that it is permissible (filter type, infeed, thresholds).
16	900F	<p>External measured value / signal state outside of the permissible range</p> <p>A measured value / signal state read in via the input area (digital/analog/temperature) has assumed an inadmissible value/state.</p> <ul style="list-style-type: none"> • Identify and check the relevant signal. • Check the set thresholds.
17	9010	<p>Application / technology function faulted</p> <p>The application / technological function has exceeded a (set) limit (position, velocity, torque...).</p> <ul style="list-style-type: none"> • Identify and check the relevant limit. • Check the setpoint specification of the higher-level controller.

8.2 Message classes in accordance with PROFIdrive

Message class	PN ¹⁾ (hex)	Explanation of the message class according to PROFIdrive - cause and remedy.
18	9011	Error in the parameterization/configuration/commissioning sequence An error has been identified in the parameterization or in a commissioning procedure, or the parameterization does not match the actual device configuration. <ul style="list-style-type: none">• Determine the precise cause of the fault using the commissioning tool.• Adapt the parameterization or device configuration.
19	9012	General drive fault Group fault. <ul style="list-style-type: none">• Determine the precise cause of the fault using the commissioning tool.

¹⁾ "Channel Error Type" of the PROFINET channel diagnostics. When channel diagnostics is activated, then the fault texts are indicated in the PLC.

8.3 Alarms

Alarms

Alarms have the following properties:

- Alarms have no direct influence on the drive.
- Alarms disappear again when the cause is eliminated.
- Alarms cannot be acknowledged.
- Alarms are displayed as follows:
 - In the PLC according to the PROFIdrive message class
 - On the drive via LEDs
 - At the drive using the three-digit display according to the PROFIdrive message class
 - In the Web server via the "Diagnostics - Messages" view

Alarm code or alarm value describe the cause of the alarm.

Reference

You can find additional information on alarms in Chapter "Overview of faults and alarms (Page 419)".

8.4 Faults

Faults

Faults have the following properties:

- The fault causes the motor to be switched off.
- Faults must be acknowledged.
- Faults are displayed as follows:
 - In the PLC according to the PROFIdrive message class
 - On the drive via LEDs
 - At the drive using the three-digit display according to the PROFIdrive message class
 - In the Web server via the "Diagnostics - Messages" view

Acknowledge fault

Before you can acknowledge a fault, you must have resolved the cause of the fault.

To acknowledge, you have the following options:

- Acknowledging via the PLC
- Acknowledging via the OK button under the front cover
- Switch off the converter power supply and switch on again
- Acknowledging via the Web server
- The Safety Integrated error is acknowledged by selecting/deselecting the STO function. Any active messages of additional Safety Integrated Functions are acknowledged simultaneously with extended message acknowledgment (p9507.0 = 1). In addition, you must execute the standard acknowledgment mechanism.

Faults detected during the converter-internal monitoring of hardware and firmware can be acknowledged only by switching the power supply off and on again. In the list of faults, you will find the information on limitations when acknowledging at the corresponding fault codes.

Reference

You can find additional information on faults in Chapter "Overview of faults and alarms (Page 419)".

Service and maintenance

9.1 Service and maintenance for the motor

If there are deviations from normal operation or if faults occur, proceed as follows.

- Identify the fault using the "Possible faults" table.
Also observe the converter messages.
- Try to correct the fault using the "Fault causes and remedial measures" key table.

 WARNING
Operation without functioning protective devices
Operation without functioning protective devices can cause death or severe injury.
<ul style="list-style-type: none"> • Operate the motor, even in test operation, only with functioning protective devices.

Table 9-1 Possible faults

Fault	Fault cause (see "Fault causes and remedial measures" key table)															
Motor does not start	A	B														
Motor starts slowly	A		C		F											
Humming sound when starting			C		F											
Humming sound in operation	A		C		F											
High temperature rise under no-load operation				D		I										
High temperature rise under load	A		C			I										
High temperature rise of individual winding sections					F											
Uneven running							J	K								
Grinding sound, running noise									L							
Radial vibrations										M	N	O	P			R
Axial vibrations												O		Q		R

Table 9-2 "Fault causes and remedial measures" key table

No.	Fault cause	Remedial measures
A	Overload	Reduce load
B	Interruption of a phase in the supply cable / motor winding	Check the frequency converter and supply cables, measure the winding resistances and insulation resistances, repair after consultation with manufacturer

Service and maintenance

9.1 Service and maintenance for the motor

No.	Fault cause	Remedial measures
C	Interrupted phase in the feeder cable after switching on	Check the frequency converter, supply cables and the winding resistances
D	Converter output voltage too high, frequency too low	Check the settings on the frequency converter, perform automatic motor identification
F	Winding short-circuit or phase short-circuit in stator winding	Measure the winding resistances and insulation resistances, repair after consultation with the manufacturer, if required, replace the motor
I	Heat dissipation impeded by deposits	Clean the surface of the drives and ensure that the cooling air can flow in and out unimpeded
	Cooling air inlet/outlet is blocked by foreign bodies	Remove the reason for the blocking and ensure that the cooling air can flow in and out unimpeded
J	Insufficient shielding for motor and/or encoder cable	Check the shielding and grounding
K	Excessive drive controller gain	Adjust the controller
L	Rotating parts are grinding	Determine cause and adjust parts
	Foreign bodies inside the motor	Replace the motor
	Bearing damage	For SH20... SH50, replace the motor; for SH63 ... SH100, replace the bearings and encoder
M	Rotor not balanced	Replace the motor
N	Rotor out of true, shaft bent	Consult the manufacturer
O	Poor alignment	Align motor set, check coupling
P	Coupled machine not balanced	Re-balance coupled machine
Q	Shocks from coupled machine	Check coupled machine
R	Fault originating from the gearbox	Adjust/repair gearbox

If the fault still cannot be resolved after taking the measures stated above, please contact the manufacturer or the Siemens Service Center.

9.1.1 Replacing the motor bearings

Motor bearings are wearing parts. They must be replaced after a defined number of operating hours.

At medium loads, the motor bearings last approx. 25000 h.

The procedure for replacing the motor bearing depends on the size of the motor.

For 1FK2□03 ... 1FK2□05 motors, it is not possible to replace the motor bearings. Replace these motors in their entirety.

Replacement of the motor bearings is only intended as from 1FK2□06.

Especially favorable ambient conditions, such as low average speed, low radial force (transverse force) and vibration load can prolong the interval until motor replacement.

Note

Premature bearing and motor replacement

Harsh operating conditions, e.g. continuous operation at n_{max} , high vibration/shock loads, frequent reversing duty reduce the bearing or motor replacement interval by up to 50 %.

9.1.2 Replacing the motor

Precondition

The new motor has the same article number as the motor to be replaced.

Note

A motor with a singleturn encoder AS22DQC (1FK2□□□_□□□□□-□S□□) can be replaced by an otherwise identical motor with a multiturn encoder AM22DQC (1FK2□□□_□□□□□-□M□□) without having to recommission the drive system.

- Replace the motor following steps 1 to 3 as explained below.

Replacing a motor with a motor with another article number

If the converter has already been operated with a motor, and you wish to replace this motor by another motor with a different article number, then after replacing the motor, you must commission the converter again.

Procedure

1. Verify absence of operating voltage to the converter.



! WARNING

Danger to life due to unintentional starting of the drive unit

Unintentional starting of the drive unit can cause death or severe injury.

- Make sure that the drive unit cannot be started accidentally.
- Post a warning notice to this effect at the point where the switch is located.

2. Replace the motor.





! CAUTION





Burns as a result of touching hot surfaces

In operation, the motor enclosure can reach high temperatures, which can cause burns if touched.

- Do not touch any hot surfaces.
- Allow the motor to cool down before starting any work.
- Use the appropriate personnel protection equipment, e.g. gloves.

- Release the motor connector. More detailed information is provided in Chapter:  Notes for connecting the round connector to the motor (Page 150)
 - Release the motor mounting screws.
 - Remove the motor.
 - Mount and install the new motor. More detailed information is provided in Chapter:  Installing the motor (Page 140)
3. Switch the converter on.

If you are using a different motor type, then you must also carry out the following steps:

1. Start the web server and log in as administrator.
 Login/logout (Page 186)
2. Reset the converter to the factory settings.
 Reset converter/password - restore the state when originally delivered (Page 270)
If message A1007 is displayed in the web server, then you must update the DRIVE-CLiQ components.
Switch the converter off and on again.
3. Commission the converter.
 -  Commissioning using the web server (Page 194),
 -  Series commissioning (Page 253)
4. Save the settings powerfail-proof via .

You have replaced the motor.



9.2 Service and maintenance for the converter

9.2.1 Converter firmware update

You have the option of upgrading your converter (upgrade) to a newer firmware version. You can also install an older firmware version (downgrade) to always provide the same machine configurations.

For an upgrade, the settings previously made are kept.

For a downgrade, the converter is reset to the factory settings.

NOTICE

Malfunctions due to interruption of the power supply or disconnecting the motor when updating the firmware

If the firmware is being updated, interrupting the power supply or disconnecting the motor, can result in defects or cause the devices to malfunction.

- Observe the information provided about the LEDs.

The firmware can be updated via the web server as well as without web server with memory card.

Updating the firmware via the web server

A description of the firmware update via the web server is provided in the following section.



Updating the firmware via the web server (Page 246)

Firmware update via memory card

Requirements

- You have an SD card with the appropriate firmware, e.g. 6SL3054-4FC00-2BA0.
- You have an empty SD card with a maximum capacity of 2 GB (e.g. 6SL3054-4AG00-2AA0) on which you can load the firmware.

You can find the firmware versions available at the following link:

Firmware versions (<https://support.industry.siemens.com/cs/ww/en/view/109744577>)







Procedure



Proceed as follows to update the firmware using the memory card:

1. Switch off the converter.
2. Insert the SD card into the converter and switch on the converter.

- The new firmware is installed – this can take up to five minutes or longer. The update is completed when both LEDs are flashing red at 1 Hz in sync with each other.

RDY	COM	Explanation of the LED displays
		Firmware update is active <ul style="list-style-type: none"> Do not switch off the power supply. Do not disconnect the motor from the converter.
		LEDs are flashing synchronously: Converter waits until the power supply is switched off and switched on again after a firmware update.

- Switch the converter off and remove the memory card.
- Switch on the converter again. The firmware of the connected DRIVE-CLiQ components is updated. This may require a restart (see alarm messages in the web server).

RDY	Explanation of the LED displays
	Firmware update in progress for the connected DRIVE-CLiQ components. <ul style="list-style-type: none"> Do not switch off the power supply. Do not disconnect the motor from the converter.
	DRIVE-CLiQ component firmware update has been completed. Waiting for POWER ON of the corresponding components. Remedy: Switch the component off and on again.

- Check whether the new version is installed. The firmware version of the converter is displayed on the home page of the web server under the converter.

9.2.2 Reset converter/password - restore the state when originally delivered

Note

If you have reset the converter to the factory settings, and you wish to operate it again in the machine, then you must first commission the converter.

For the following use cases, you must restore the factory settings for the converter.

- You wish to delete the complete parameterization
- You wish to connect another motor
- You have forgotten the administrator password
- You wish to restore the device to its state when originally delivered

The procedure differs depending on the particular use case.

- Proceed as follows corresponding to your particular use case.
-

Note

Communication settings

If you reset the converter to the factory settings, the IP address of the service interface, the PROFINET IP address and the PROFINET device name are not cleared.

Use PRONETA or the TIA Portal if you wish to clear these settings.

 PRONETA (<https://support.industry.siemens.com/cs/de/en/view/67460624>).

Clearing the complete parameterization

- Clear the complete parameterization using the web server by restoring the converter to its factory settings.

You can find the appropriate information at  Restoring factory settings (Page 239)

Connecting another motor

If you wish to replace the motor with a motor with a different article number, then proceed corresponding to the steps in the following chapter.

 Replacing the motor (Page 266)

You have forgotten the administrator password

If you have forgotten the administrator password, then you cannot restore the factory settings of the converter via the web server.

You must reset the converter with a memory card.

Procedure

1. Use a text editor to create a file with the following content: UPDATE_FORMAT_RW 0 1
Save the file under the following name: updater.inf
Alternatively, you can download this file from the Internet at the following link:
 Updater (<https://support.industry.siemens.com/cs/ww/de/view/109755657>) .
2. Copy the file "updater.inf" to an empty SD card (max. 2 GB, e.g. 6SL3054-4AG00-2AA0).
3. Switch the converter off and insert the SD card into the card slot of the converter.
4. Switch the converter on.
5. Wait until the converter has run up. The RDY LED is then continuously green.
6. Switch the converter off and remove the SD card.
7. Switch the converter on. The RDY LED is then continuously green.

You have reset the converter to the factory settings.



You can now assign a new administrator password and recommission the converter in the web server.



Logging on for the first time and assigning an administrator password (Page 183)



Commissioning using the web server (Page 194)

Restoring the original settings

You can only restore the factory settings using a memory card.

For this procedure, it is not permissible that a motor is connected.

- Disconnect all of the electrical connections to the motor (encoder, power and brake cables).
- Disconnect the PROFINET connection to the control system and other devices.

The factory settings are restored in 2 steps.

1. Clear the communication settings of the converter. To do this, use the commissioning and diagnostics tool for PROFINET - PRONETA - for example.
 PRONETA (<https://support.industry.siemens.com/cs/de/en/view/67460624>).

2. Reset the converter to its original settings.

Carry out steps 1 and 2 as described below.

Clearing the communication settings**Procedure**

1. Establish a connection with the service interface (X127).
2. Clear the converter IP address.
3. Establish a connection with the PROFINET interface (X150).
4. Clear the PROFINET communication settings.

You have now cleared all the converter communication settings.



Restoring the original settings of the converter



Procedure

1. Use a text editor to create a file with the following content: UPDATE_FORMAT_RW 0 1
Save the file under the following name: updater.inf
Alternatively, you can download this file from the Internet at the following link:
 Updater (<https://support.industry.siemens.com/cs/ww/de/view/109755657>).
2. Copy the file "updater.inf" to an empty SD card (max. 2 GB, e.g. 6SL3054-4AG00-2AA0).
3. Switch the converter off and insert the SD card into the card slot of the converter.
4. Switch the converter on.
5. Wait until the converter has run up. The RDY LED flashes green with 0.5 Hz
6. Switch the converter off and remove the SD card.

You have now reset the converter to the state when originally supplied.

□

If you wish to operate the converter again in the machine, then you must first commission the converter.

-  Commissioning using the web server (Page 194)
-  Series commissioning (Page 253)

9.2.3 Replacing fans - only for converters with 3 AC line connection

The fan module is installed in the lower section of the converter.

Service life of the fan

The average service life of the fan is 40,000 hours. However, in practice the service life may be shorter. Especially a dusty environment can block up the fan.

The fan must be replaced in good time to ensure that the converter remains ready for operation.

You can find the article number for the replacement fan in the following Section:

 Spare parts (Page 343)

Replacing fans

Proceed as follows to remove the fan module:

Procedure

1. Switch off the converter power supply.
2. Remove the converter if necessary. To do so, release all connections at the converter.

 WARNING
Electric shock as a result of a residual charge in power components
After the power supply has been switched off, it takes up to 5 min. until the capacitors in the inverter have discharged so that the residual charge is at a non-hazardous level.
<ul style="list-style-type: none">• Check the voltage at the converter connections before you carry out any installation work.

3. Remove the fan as shown in the diagram.

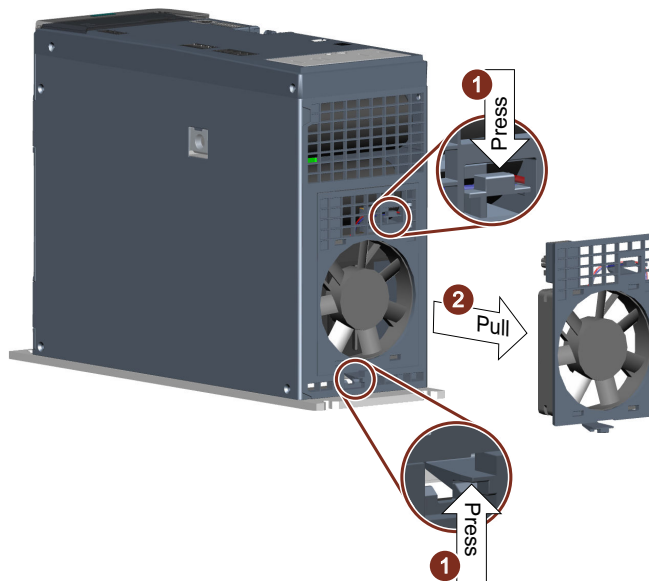

4. Install the new fan in the reverse order.
5. Set the operating hours counter (p0251) for the fan to 0.
Via the web server:  Changing parameter values (Page 182)

You have now replaced the fan.

9.2.4 Replacing the converter in a spare part scenario

When replacing converters in a spare part scenario, it is imperative that the same converter type with the same power output is used.

In order to simply replace a converter when necessary, we recommend operating the converter with an SD card, which in addition to the converter settings (parameterization), also includes the converter firmware.

In this case, you only have to replace the converter, insert the SD card and switch it on.

All of the replacement options are described in detail below.

9.2.4.1 Replacing the converter with memory card

If you operate the converter with an SD card, and the converter configuration was saved after commissioning, then the configuration data is also saved in the "User" file folder on the memory card.

Operation with SD card with firmware

How can you identify as to whether the SD card contains the firmware?

In addition to the "USER" folder, the SD card also includes other files and the "ADDON" and "SIEMENS" folders.

Procedure

1. Switch off the converter.
2. Remove the card from the converter.
3. Release all of the connections at the converter, replace the converter and re-establish the connections.



Installing the converter (Page 144)

Connecting the converter (Page 155)

4. Insert the memory card into the converter.
5. Switch the converter on.
The converter possibly upgrades/downgrades the firmware and must be switched off and switched on again.

You have now replaced the converter.

Operation with SD card without firmware

Procedure

1. You replace the converter as described above in steps 1. ... 5.
2. Case 1, the new converter has the same or a higher firmware version:
 - When it runs up, the converter takes the settings from the card, and after it has run up commissioning has been completed. For a higher firmware version, then the DQ components are updated (encoder).
 - Switch the converter off and on again.

Case 2, the new converter has an older firmware version:

- The converter is reset to the factory settings once it has run up. You can recognize this as the dialog screen form is displayed in the web server for the first login. In this case, switch off the converter without saving – and withdraw the SD card from the converter. Restore the firmware to the version that was on the replaced converter.

Note

Review the machine documentation, or check which version is installed on the other S210 converters in the machine.



Converter firmware update (Page 268)

Switch off the converter, insert the SD card with converter settings into the converter and switch the converter on again.

When it runs up, the converter takes the settings from the card, and after it has run up commissioning has been completed.

Save the settings in the web server in a non-volatile fashion using .

You have now replaced the converter.



9.2.4.2 Replacing the converter without memory card

Operation without SD card, data backup is not available

Basic information on working with the web server is provided in the following section:

 Fundamentals (Page 178)

Procedure

1. Switch off the converter.
2. Release all of the connections at the converter, replace the converter and re-establish the connections.

 Installing the converter (Page 144)

 Connecting the converter (Page 155)

3. Switch the converter on.
4. Carry out a complete commissioning procedure
 Commissioning using the web server (Page 194)

You have now replaced the converter.



Operation without SD card, data backup is available

Procedure

1. Switch off the converter.
2. Release all of the connections at the converter, replace the converter and re-establish the connections.

 Installing the converter (Page 144)

 Connecting the converter (Page 155)

3. Switch the converter on.
4. Assign the administrator password.
5. Log in as administrator.

6. Select "Backup and Restore" in the navigation, then "Restore parameters from file".
7. Download the data backup to the converter.
Case 1, the new converter has the same or a higher firmware version:
 - When it runs up, the converter takes the settings from the data backup, and after it runs up, commissioning is completed.
 - For a higher firmware version, then the DQ components are updated (encoder). The converter must be switched off and switched on again.Case 2, the new converter has an older firmware version:
 - The converter is reset to the factory settings once it has run up.
You can recognize this as the dialog screen form for the first log in is displayed.
Restore the firmware to the version that was on the replaced converter.

Note

Review the machine documentation, or check which version is installed on the other S210 converters in the machine.



Converter firmware update (Page 268)

Download the data backup to the converter.

When it runs up, the converter takes the settings from the data backup, and after it runs up, commissioning is completed.

Save the settings in the web server in a non-volatile fashion via

You have now replaced the converter.



Technical specifications

10.1 Technical data and properties of the motor

10.1.1 Technical features

Property	Version
Type of motor	Permanent-magnet synchronous motor
Rotor inertia	1FK21 - High Dynamic - motor with low rotor inertia 1FK22 - Compact - motor with average rotor inertia
Cooling	Natural cooling
Insulation of the stator winding according to EN 60034-1 (IEC 60034-1)	1FK2□02, 1FK2□03: Temperature class 130 (B) for a winding temperature of $\Delta T = 80$ K at an ambient temperature of +40 °C 1FK2□04, 1FK2□05, 1FK2□06, 1FK2□08, 1FK2□10: Temperature class 155 (F) for a winding temperature of $\Delta T = 100$ K at an ambient temperature of +40 °C
Pulse voltage insulation class according to EN 60034-18-41 (IEC 60034-18-41)	IVIC: C
Operating range	-15 to +40 °C, derating at higher temperatures
Installation altitude (according to EN 60034-1 and IEC 60034-1)	≤ 1000 m above sea level, otherwise power derating
Type of construction according to EN 60034-7 (IEC 60034-7)	IM B5 (IM V1, IM V3)
Degree of protection according to EN 60034-5 (IEC 60034-5)	IP64, optional IP65
Temperature monitoring	Thermal motor model
Paint finish	Anthracite (RAL 7016)
Shaft extension according to DIN 748-3 (IEC 60072-1)	Plain shaft, optionally with feather key and half-key balancing,
Radial eccentricity, concentricity, and axial eccentricity according to DIN 42955 (IEC 60072-1) ¹⁾	Tolerance N (normal)
Vibration severity grade according to EN 60034-14 (IEC 60034-14)	Grade A is maintained up to rated speed
Sound pressure level L_{pA} (1 m) according to DIN EN ISO 1680, max. tolerance + 3 dB(A)	55 dB(A)
Encoder systems, built-in with DRIVE-CLiQ interface	<ul style="list-style-type: none"> AS22DQC, absolute encoder singleturn 22 bit (code letter: S) AM22DQC, absolute encoder 22 bit + 12 bit multiturn (code letter: M)

10.1 Technical data and properties of the motor

Property	Version
Connection	One cable system (OCC), rotatable
Holding brake	Optional integrated holding brake

- ¹⁾ Radial eccentricity of the shaft extension, concentricity of centering edge, and axial eccentricity of the mounting flange to the axis of the shaft extension.

10.1.2 Permissible environmental conditions for the motor

Environmental conditions for transport in the transport packaging according to Class 2K3 to EN 60721-3-2, except for the "air temperature" and "condensation" environmental factors	
Climatic environmental conditions	- 15° C ... + 70° C
Highest relative humidity	< 95% at 40° C, condensation not permissible
Mechanical environmental conditions	Shock and vibration permissible according to 3M8 to EN 60721-3-3: Single shocks (6 ms) max. 250 m/s ²
Protection against chemical substances	Protected according to Class 2C2
Biological environmental conditions	Suitable according to Class 2B2

Environmental conditions for long-term storage in the transport packaging according to Class 1K3 to EN 60721-3-1, except for the "air temperature", "highest relative humidity" and "condensation" environmental factors	
Climatic environmental conditions	- 15° C ... + 55° C
Highest relative humidity	< 60% - condensation not permissible
Mechanical environmental conditions	Vibration-free storage space, $v_{rms} < 0.2$ mm/s
Protection against chemical substances	Protected according to Class 1C2
Biological environmental conditions	Suitable according to Class 1B2
Duration	<ul style="list-style-type: none"> • Six months for the above-mentioned conditions. • Special preservation measures are required for storage periods of 6 months up to a maximum of two years. Additional information  Calling Support information (Page 190)

Ambient conditions during operation according to 3K4 to EN 60721-3-3, except for the "low air temperature", "condensation" and "low air pressure" environmental factors	
Installation altitude	Up to 1000 m above sea level without limitations  Derating factors (Page 283)
Climatic environmental conditions ¹⁾	<ul style="list-style-type: none"> • Temperature range: - 15 °C ¹⁾ ... + 40 °C • Relative humidity: 5 ... 95%, condensation not permitted • Absolute air humidity: 1 ...29 g/m³ • Rate of temperature change²⁾: 0.5°/min • Atmospheric pressure: 89 ^{1), 3)} ... 106 kPa⁴⁾ • Solar radiation: 700 W/m² ²⁾ • Movement of the air: 1.0 m/s • Water (other than rain): See protection class
Mechanical environmental conditions	<ul style="list-style-type: none"> • Vibration levels permissible according to Class 3M8 to EN 60721-3-3: Max. 50 m/s² • Shock permissible according to Class 3M8 to EN 60721-3-3
Protection against chemical substances	Protected according to 3C2 to EN 60721-3-3
Biological environmental conditions	Suitable according to 3B2 to EN 60721-3-3
Pollution	Suitable for environments with degree of pollution 2 according to EN 61800-5-1
Cooling air	Clean and dry air
<p>The motors are not suitable for operation</p> <ul style="list-style-type: none"> • In a vacuum⁵⁾ • In salt-laden or aggressive atmospheres • Outdoors 	

¹⁾ Increased ruggedness with regard to low temperature and low atmospheric pressure better than 3K3 according to EN 60721-3-3

²⁾ Averaged over a period of 5 min

³⁾ The limit value of 89 kPa covers applications at altitudes up to 1000 m.

⁴⁾ Conditions in mines are not considered.

⁵⁾ Operation in a vacuum is not permissible because of the low dielectric strength and poor heat dissipation.

10.1.3 Cooling

The 1FK2 is a non-ventilated motor.

To ensure sufficient heat dissipation when installed, the motor requires a minimum clearance of 100 mm from adjacent components on three lateral surfaces.

- Maintain these clearances irrespective of the following mounting variants.

Non-thermally insulated mounting

Some of the motor power loss is dissipated through the flange when the motor is connected to the mounting surface.

- Observe the following mounting conditions for the specified motor data:

Shaft height	Steel plate, width x height x thickness (in mm)
1FK2□02	200 x 200 x 6
1FK2□03	250 x 250 x 6
1FK2□04	
1FK2□05	450 x 370 x 30
1FK2□06	
1FK2□08	
1FK2□10	

The data in the table refers to an ambient temperature of 40 °C and an installation altitude up to 1000 m above sea level.

If the environmental conditions are different, derating may be required. For more information, refer to Chapter:

 "Derating factors (Page 283)"

For larger mounting surfaces, the heat dissipation conditions improve.

Thermally insulated mounting without additional mounted components

The subsequent description is only applicable for motors, frame sizes 1FK2□02 ... 1FK2□04.

For self-cooled motors, you must reduce the S1/characteristic curve as follows:

Reduce the motor static torque by 20% to 30%.

Reduce the torque at 3000 rpm by 40 to 50%.

Thermal motor protection

The converter monitors the motor temperature based on a thermal motor model and issues the alarm "Motor overtemperature" before the maximum temperature is reached. If the motor exceeds the maximum temperature, the converter switches off the motor with the error message "Motor overtemperature".

The thermal motor model requires the ambient temperature to be entered at the converter.

- To do this, select parameter p0613 at the converter.

Parameter r0034 indicates the thermal load of the motor as a percentage. The reading is influenced by the ambient temperature selected in parameter p0613.

Further information can be found in the parameter lists:

 "Parameters (Page 349)"

10.1.4 Derating factors

Given an ambient temperature > 40 °C or installation altitude > 1000 m above sea level, the permissible torques/powers must be determined with the factors from the following table.

The factors refer to the static torque M_0 . Shift the S1 characteristic curve in parallel.

Table 10-1 Power derating depending on the installation altitude and the ambient temperature

Installation altitude above sea level in m	Ambient temperature in ° C			
	30	40	45	50
1000	1.08	1.00	0.96	0.91
2000	1.02	0.93	0.89	0.84
3000	0.95	0.86	0.81	0.75
4000	0.88	0.77	0.72	0.66

Calculate the derating value for ambient temperatures that are not shown here and installation altitudes below the maximum values by interpolating. For example: 40 °C at 1500 m above sea level = derating factor 0.975

10.1.5 Degree of protection

IP = International Protection

1st digit = protection against the ingress of foreign bodies

2nd digit = protection against water

DIN 60034-5 is valid for water as potentially occurring medium, not for oil or other creeping fluids.

Configure the motor in the required degree of protection.

Degrees of protection available for the 1FK2

1FK2 motors are available with IP64 or IP65 degree of protection.

The degree of protection is specified on the rating plate.

The motors with IP65 degree of protection have a radial shaft seal.

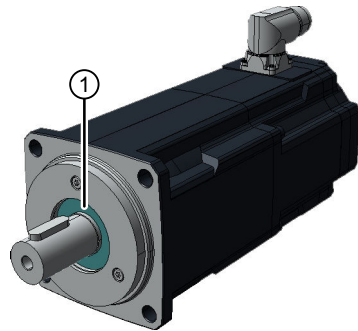

1FK2□03 ... 1FK2□04

① radial shaft seal ring

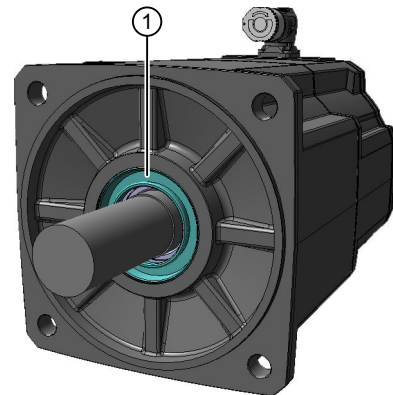

1FK2□05 ... 1FK2□10

For 1FK2□03 and 1FK2□04, the radial shaft sealing ring shortens the shaft extension that can be used.

Note

It is permissible that the radial shaft sealing ring runs dry.

With degree of protection IP65, it is not permissible for liquid to collect in the flange.

The service life of the radial shaft sealing ring is approximately 25000 operating hours.

For additional information, see Chapter:

 "Shaft extension (Page 286)"

10.1.6 Balancing

The motors are balanced according to DIN ISO 8821.

Motors with featherkey in the shaft are half-key balanced.

A mass equalization for the protruding half key must be taken into account for the output elements.

10.1.7 Vibration response

Vibration severity grade

The vibration response of the system at the location of use is influenced by output elements, any built-on parts, the alignment, the installation, and external vibrations. This can change the vibration values of the motor.

The motors conform to vibration severity grade A according to EN 60034-14 (IEC 60034-14).

The specified values refer only to the motor. The installation-dependent system vibration behavior can increase these values at the motor.

The vibration severity grade is maintained up to the rated speed (n_N).

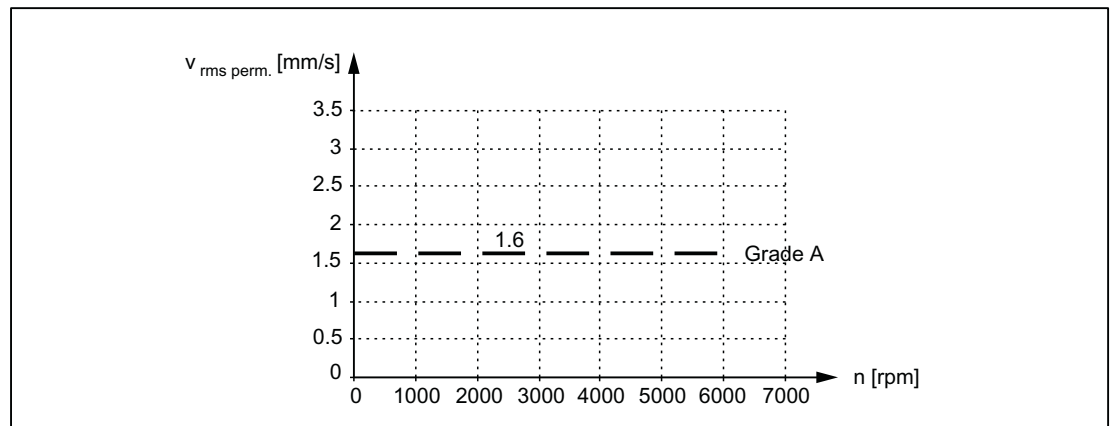

Figure 10-1 Vibration severity levels

Permissible vibration in operation

In order to guarantee the proper function of the motor and not to impair the lifetime of the bearing, the following vibration values must be observed during operation.

- Vibration velocity ¹⁾ V_{rms} according to ISO 10816 Max. 4.5 mm/s
- Vibration acceleration a_{peak} axial ²⁾ 50 m/s²
- Vibration acceleration a_{peak} radial ²⁾ 50 m/s²

¹⁾ To measure the vibration velocity, the measuring equipment must fulfill the requirements of ISO 2954.

²⁾ The vibration acceleration is evaluated in the frequency range of 10 Hz to 2000 Hz. The maximum peak in the time range is considered.

10.1 Technical data and properties of the motor

Select the measuring points according to ISO 10816-1 section 3.2. The vibration values must not exceed the specified limits at any measuring point.

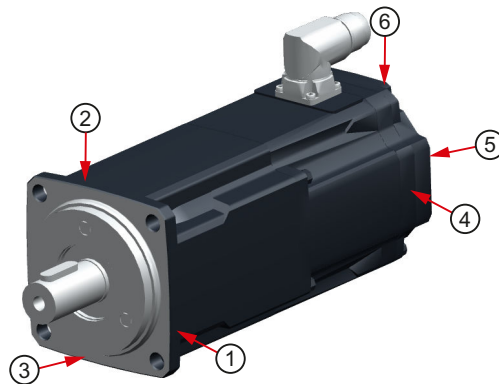

- 1 End shield DE radial
- 2 End shield DE radial
- 3 End shield DE axial
- 4 End shield NDE radial
- 5 End shield NDE axial
- 6 End shield NDE radial

Measuring points for vibration values

10.1.8 Shaft extension

The motors are supplied with cylindrical shaft extensions. The shaft extension usually has a centering thread according to DIN 332, form DR.

Optionally, a shaft extension with keyway and fitted key is available.

With motors 1FK2□02 ... 1FK2□04 the useable shaft extension is reduced by the radial shaft sealing ring with the IP65 degree of protection.

Shaft height	Shaft dimensions Diameter x length in mm	Shaft dimensions with IP65 Diameter x length in mm	Feather key Width x height x length in mm	Centering thread DIN 332-DR
1FK2□02	8 x 25	8 x 18	2 x 2 x 10	M3
1FK2□03	14 x 30	14 x 21.5	5 x 5 x 16	M5
	11 x 23 ¹⁾	-	-	M4
1FK2□04	19 x 40	19 x 32	6 x 6 x 22	M6
1FK2□05	19 x 40		6 x 6 x 32	M6
1FK2□06	24 x 50		8 x 7 x 40	M8
1FK2□08	32 x 58		10 x 8 x 45	M12
1FK2□10	38 x 80		10 x 8 x 70	M12

¹⁾ The optional 11 mm x 23 mm shaft extension is only available without a keyway and without a shaft sealing ring (IP65).

10.1.9 Radial eccentricity, concentricity and axial eccentricity

The shaft and flange accuracies for the 1FK2 motors are implemented to DIN 42955 (IEC 60072-1) as standard (Normal class).

Table 10-2 Radial eccentricity tolerance of the shaft to the frame axis (referred to cylindrical shaft ends)

Motor	Standard (Normal class)
1FK2□02	0.03 mm
1FK2□03	0.035 mm
1FK2□04 1FK2□05 1FK2□06	0.04 mm
1FK2□08 1FK2□10	0.05 mm

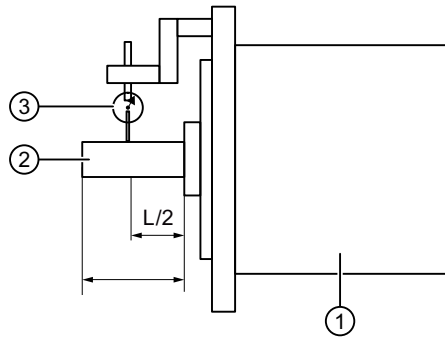

- ① Motor
- ② Motor shaft
- ③ Dial gauge

Figure 10-2 Checking the radial eccentricity

Table 10-3 Concentricity and axial eccentricity tolerance of the flange surface to the shaft axis (referred to the centering diameter of the mounting flange)

Motor	Standard (Normal class)
1FK2□02 1FK2□03 1FK2□04 1FK2□05	0.08 mm
1FK2□06 1FK2□08 1FK2□10	0.1 mm

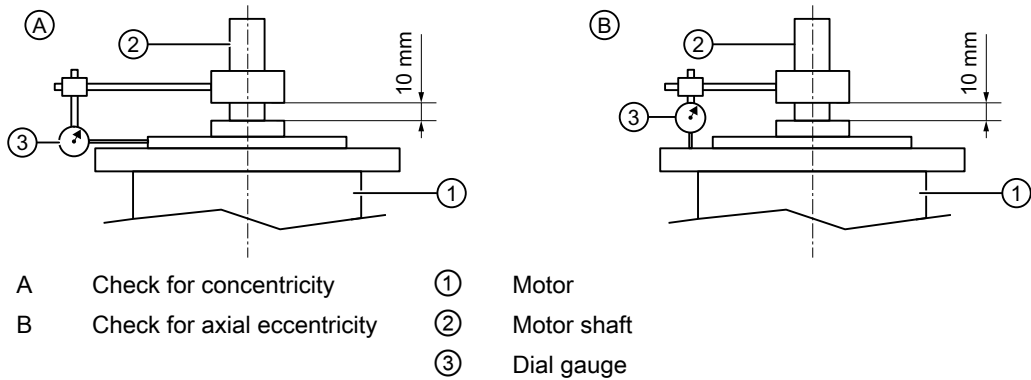

Figure 10-3 Checking the concentricity and axial eccentricity

10.1.10 Axial and radial forces

Permissible axial forces

Type	Axial force, dynamic ¹⁾ $F_{A\text{ dyn}} / \text{N}$	Axial force, static ¹⁾ $F_{A\text{ stat}} / \text{N}$
1FK2□02	20	30
1FK2□03	40	75
1FK2□04	60	100
1FK2105	75	120
1FK2106	125	200
1FK2205	75	120
1FK2206	125	200
1FK2208	250	300
1FK2210	400	450

¹⁾ The specified axial forces are determined by the spring loading and therefore also apply for motors with holding brake.

Note

Applications with an angular toothed pinion directly on the motor are not permitted with standard bearings because the permissible axial forces are exceeded.

Permissible radial forces

As a result of the bearing arrangement, 1FK2 is designed for aligned forces. Forces such as these occur for belt drives, for example.

All radial forces always refer to aligned forces.

NOTICE

Motor damage caused by circulating forces

Circulating forces can cause bearing motion, and therefore damage the motor.

- Circulating forces are not permissible.

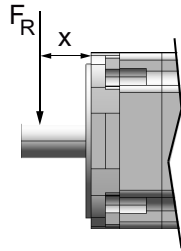

F_R Point of application of the radial force

x Distance between where the radial force is applied and the shaft shoulder in mm

Figure 10-4 Force application point at the DE (A side)

Point of application of radial forces F_R at the shaft extension

The following diagrams indicate the maximum permissible radial force for the corresponding motor frame size. It depends on the force application point and the average speed for a nominal bearing service life (L10h) of 25000 h.

Radial force diagram 1FK2x02

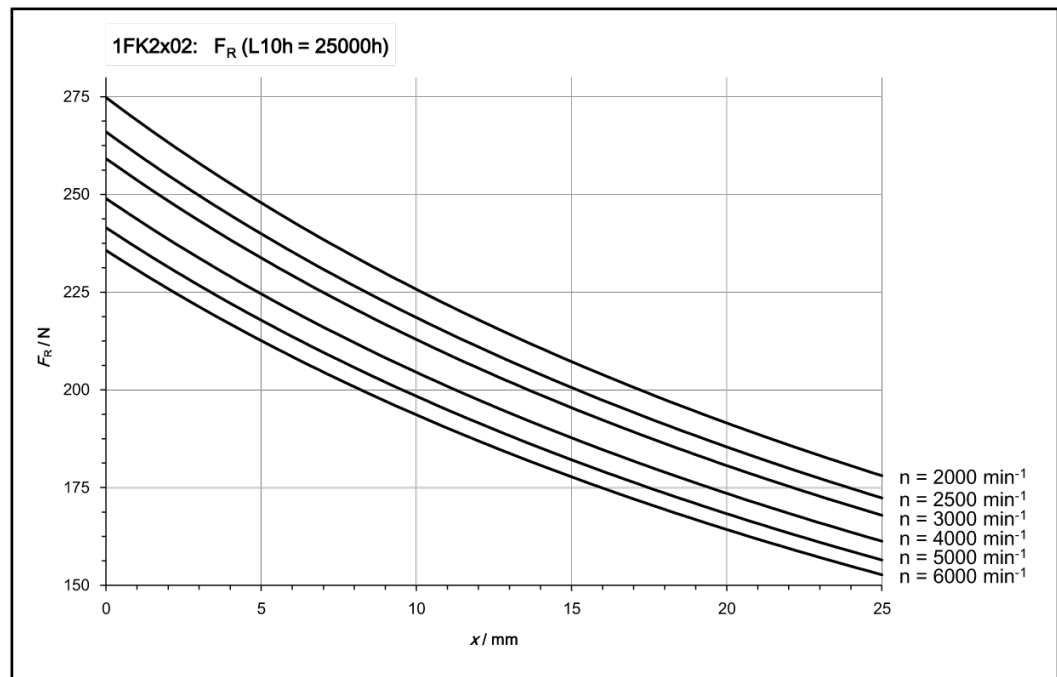

10.1 Technical data and properties of the motor

Figure 10-5 Maximum permissible radial force F_R at a distance x from the shaft shoulder for a nominal bearing lifetime of 25000 h.

Radial force diagram 1FK2x03

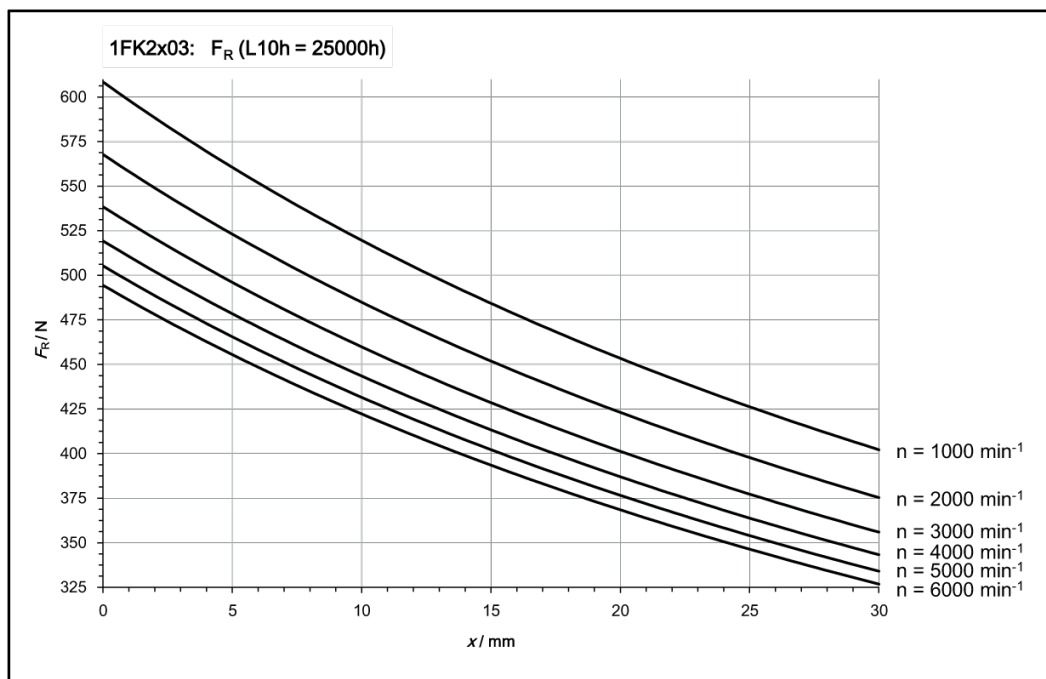

Figure 10-6 Maximum permissible radial force F_R at a distance x from the shaft shoulder for a nominal bearing lifetime of 25000 h.

Radial force diagram 1FK2x04

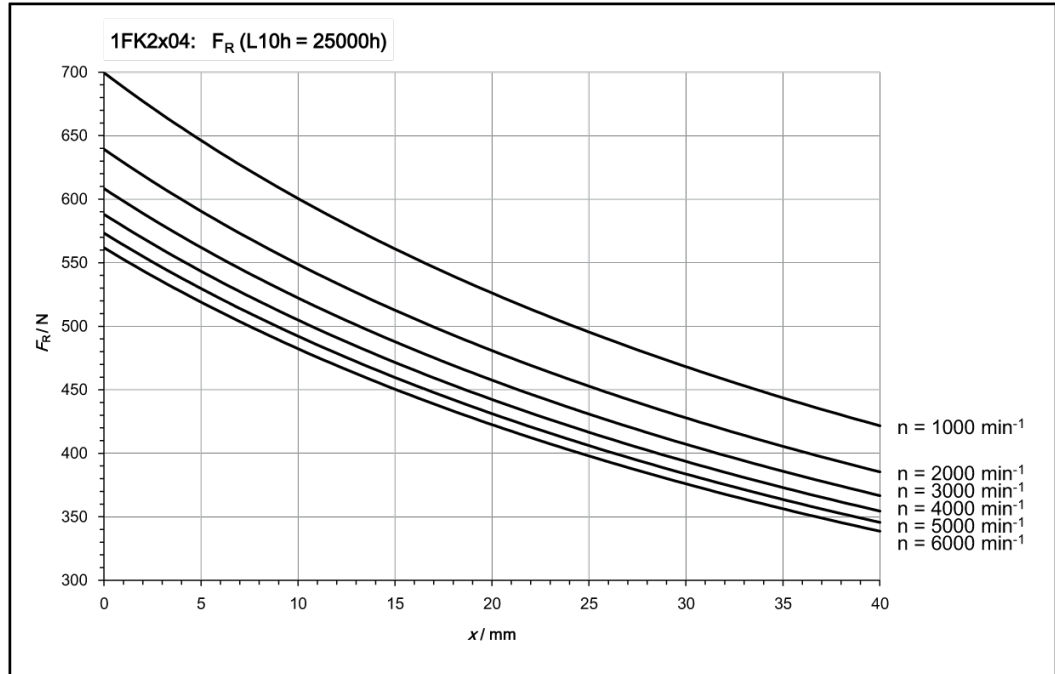
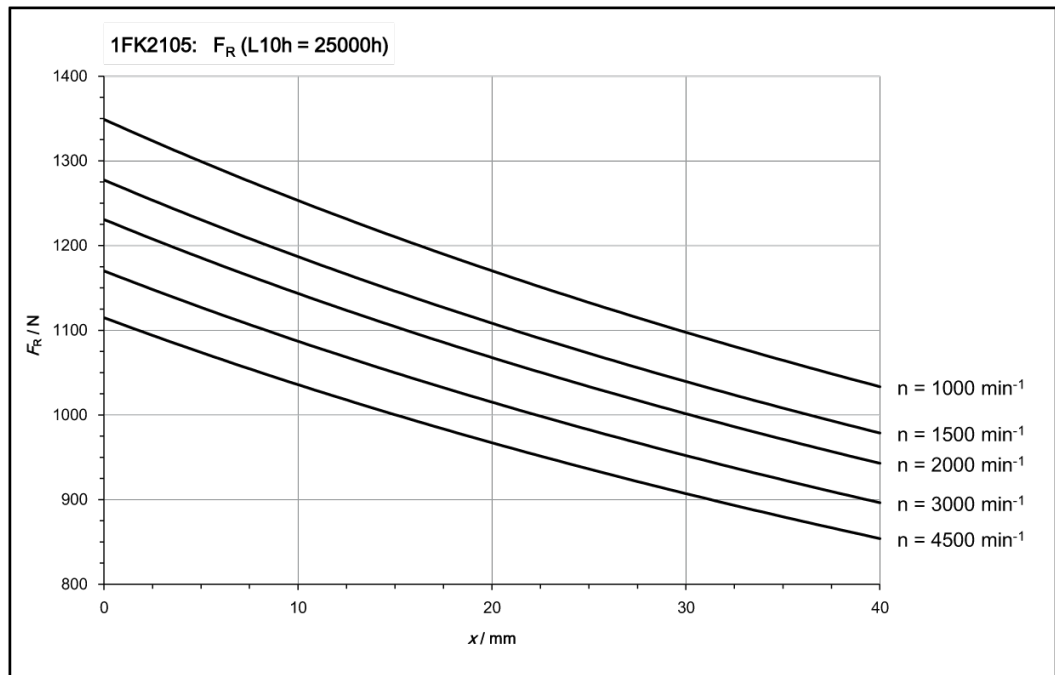

Figure 10-7 Maximum permissible radial force F_R at a distance x from the shaft shoulder for a nominal bearing lifetime of 25000 h.

Radial force diagram 1FK2105



10.1 Technical data and properties of the motor

Figure 10-8 Maximum permissible radial force F_R at a distance x from the shaft shoulder for a nominal bearing lifetime of 25000 h.

Radial force diagram 1FK2205

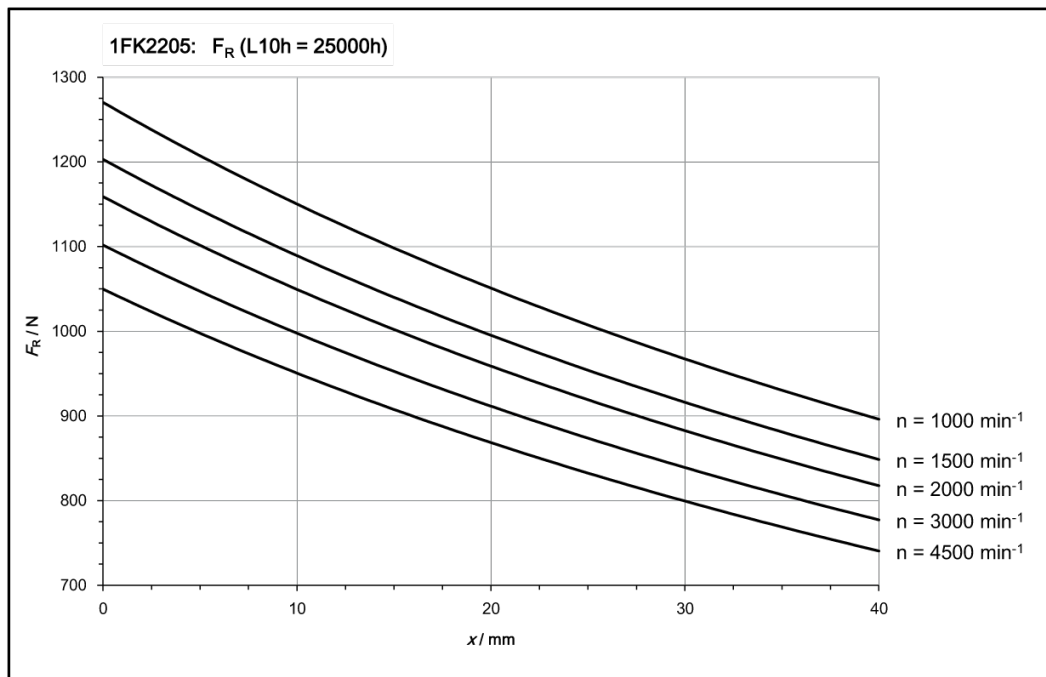

Figure 10-9 Maximum permissible radial force F_R at a distance x from the shaft shoulder for a nominal bearing lifetime of 25000 h.

Radial force diagram 1FK2x06

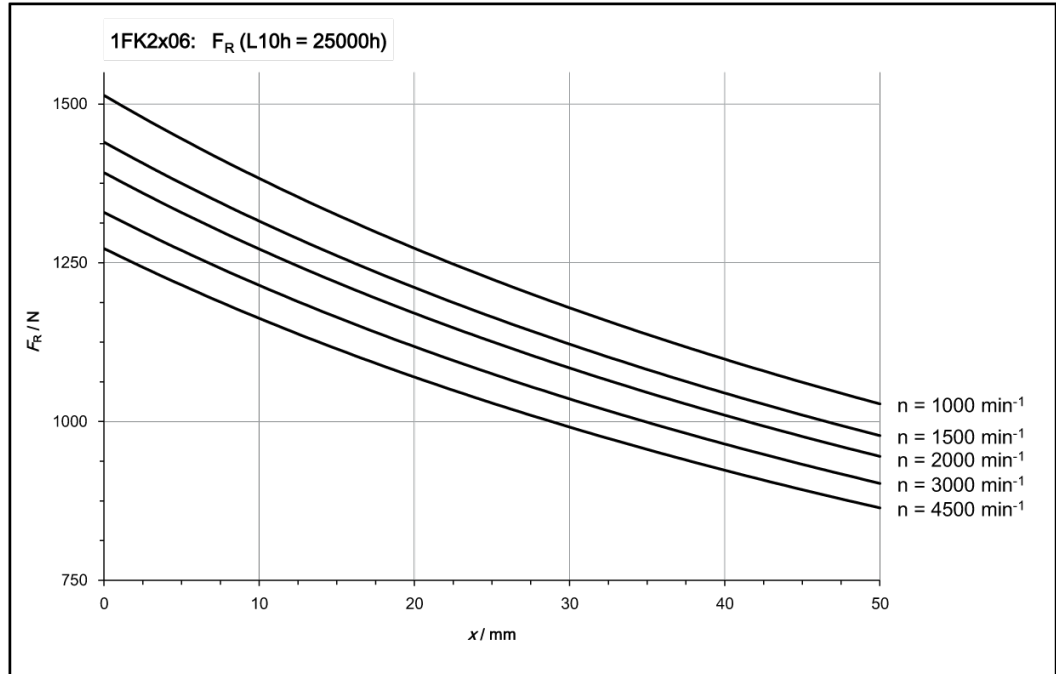
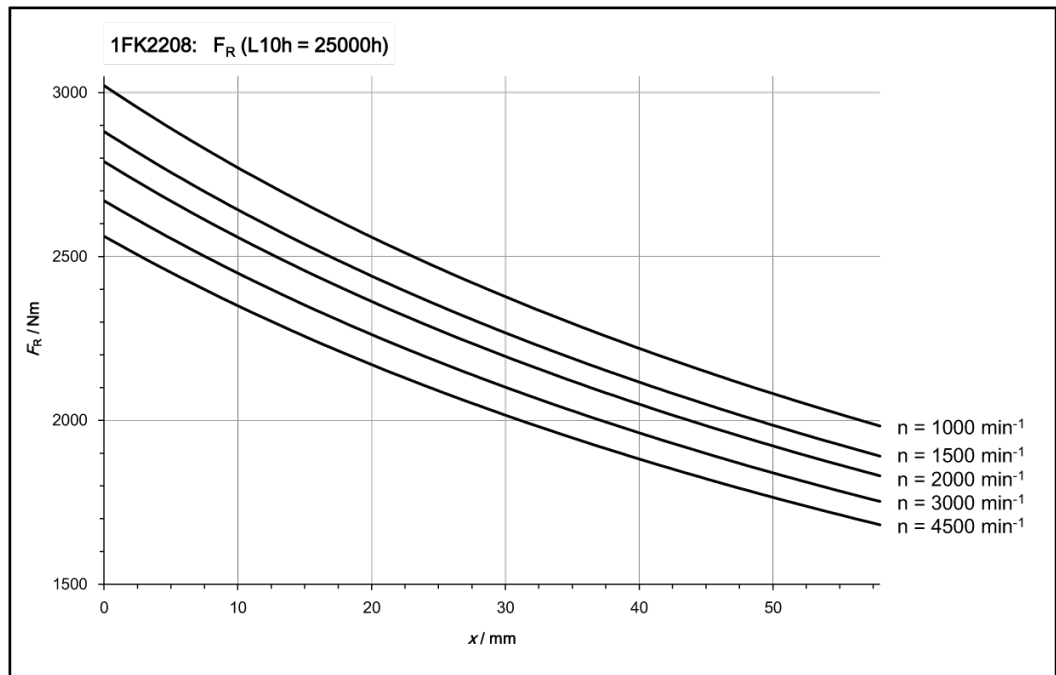

Figure 10-10 Maximum permissible radial force F_R at a distance x from the shaft shoulder for a nominal bearing lifetime of 25000 h.

Radial force diagram 1FK2208



10.1 Technical data and properties of the motor

Figure 10-11 Maximum permissible radial force F_R at a distance x from the shaft shoulder for a nominal bearing lifetime of 25000 h.

Radial force diagram 1FK2210

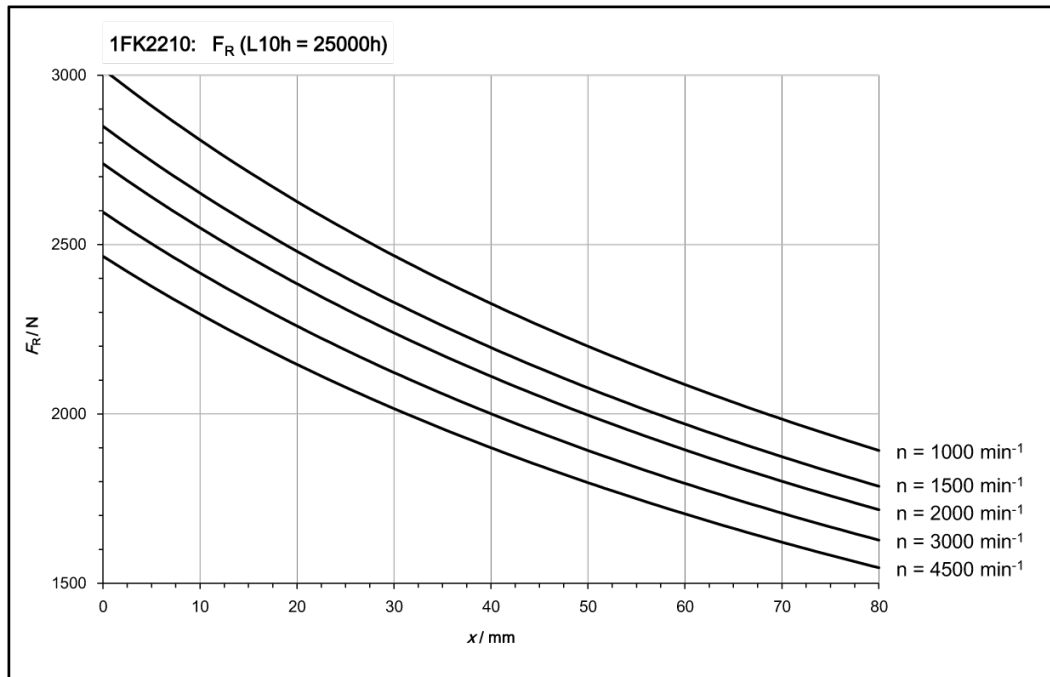

Figure 10-12 Maximum permissible radial force F_R at a distance x from the shaft shoulder for a nominal bearing lifetime of 25000 h.

10.1.11 Available encoders

	Encoders that can be ordered for the 1FK2:	
	Absolute encoder, singleturn, 22 bit	Absolute encoder 22 bit +12 bit multiturn
Encoder designation	AS22DQC	AM22DQC
Identification in the article number	S	M
Resolution	4,194,304 = 22 bit	4,194,304 = 22 bit
Absolute position	Yes, one revolution	Yes, 4096 revolutions (12 bits)
Angular error	$\pm 100''$	$\pm 100''$

10.1.12 Brake data

The holding brake is used to clamp the motor shaft when the motor is at a standstill. The holding brake is not a working brake for braking the rotating motor. When the motor is at a standstill, the holding brake is designed for at least 5 million switching cycles.

Limited EMERGENCY STOP operation is permissible. Take into account the maximum permissible individual operating energy as well as service life, total operating energy of the brake.

 WARNING
Unintentional movements through inadequate braking effect
If you use the holding brake incorrectly, e.g. as an operating brake or you ignore the permissible operating energy of the brake, then the brake will be subject to excessive and impermissible wear. As a consequence, there may be no brake effect. Unintentional movements of the machine or system can result in death or serious injury.
<ul style="list-style-type: none"> • Observe the permissible number of operating cycles and EMERGENCY STOP properties. • Operate the motor only in conjunction with an intact brake. • Avoid repeated brief acceleration of the motor against a holding brake that is still closed.

The holding brakes of the 1FK2 have a torsional backlash of less than 1.5°.

The following table lists additional technical data regarding the holding brakes for operation with a SINAMICS S210 converter from firmware version 5.2.

Motor type	Holding torque at 120 °C	Dyn. braking torque	Opening time	Closing time	Maximum permissible individual operating energy ¹⁾	Total operating energy (service life)
	M_4 / Nm	M_{1m} / Nm	t / ms	t / ms	W / J	W_{max} / kJ
1FK2□02	0.32	0.32	25	8	7.4	1.75
1FK2□03	1.3	1.3	40	10	62	17.5
1FK2□04	3.3	3	110	15	270	120

¹⁾ Maximum three EMERGENCY STOP operations in sequence

²⁾ Available soon

Holding torque M_4

The holding torque M_4 is the highest permissible torque for the closed brake in steady-state operation without slip (holding function when motor is at standstill). The data applies for the state at operating temperature (120 °C).

Dynamic braking torque M_{1m}

The dynamic braking torque M_{1m} is the smallest mean dynamic braking torque that can occur for an EMERGENCY STOP.

Opening time and closing time

The delay times that occur when switching the brake.

Maximum permissible single operating energy

10.1 Technical data and properties of the motor

The maximum permissible single operating energy of an individual EMERGENCY STOP operation.

After an EMERGENCY STOP with the maximum single operating energy, allow for a cooling time of at least 3 minutes before you operate the motor again.

Maximum EMERGENCY STOP speed

Maximum permitted speed for a safe EMERGENCY STOP procedure.

Total operating energy (service life)

The total operating energy is the sum of the single operating energy (operating energy for each EMERGENCY STOP procedure). If the total operating energy is exceeded, flawless functioning of the brakes can no longer be guaranteed.

- Refurbish the motor.

Formula for calculating the operating energy per braking operation

$$W_{BR} = (J_{Mot Br} + J_{load}) \cdot n_{mot}^2 / 182.4$$

W_{Br} / J Operating energy per braking operation

n_{Mot} / rpm Speed at which the brake is engaged

$J_{Mot Br}$ / kgm² Rotor moment of inertia of the motor with brake

You can find this information in the chapters:

 "Technical data and characteristics 1FK2 High Dynamic (Page 296)" or

 "Technical data and characteristics 1FK2 Compact (Page 303)"

J_{load} / kgm² Load moment of inertia of the mounting part on the motor with brake (kgm²)

182.4 Constant for calculating the circular frequency and SI units

10.1.13 Technical data and characteristics 1FK2 High Dynamic

10.1.13.1 1FK2102-0AG

Technical data (in SINAMICS S210 system)	Symbol	Unit	Value
Static torque	M_0	Nm	0.16
Stall current	I_0	A	0.75
Maximum permissible speed	n_{max}	rpm	8000
Maximum torque	M_{max}	Nm	0.56
Maximum current	I_{max}	A	3.1
Thermal time constant	T_{th}	rpm	14
Rotor moment of inertia	J_{mot}	kgcm ²	0.0245
Rotor moment of inertia (with brake)	$J_{mot br}$	kgcm ²	0.0285
Weight	m_{mot}	kg	0.47
Weight (with brake)	$m_{mot br}$	kg	0.73
Rated data for S210 connected to 1 AC 230 V, 3 AC 240 V			
Rated speed	n_{rated}	rpm	3000

10.1 Technical data and properties of the motor

Rated torque	M_{rated}	Nm	0.16
Rated current	I_{rated}	A	0.75
Rated power	P_{rated}	kW	0.05

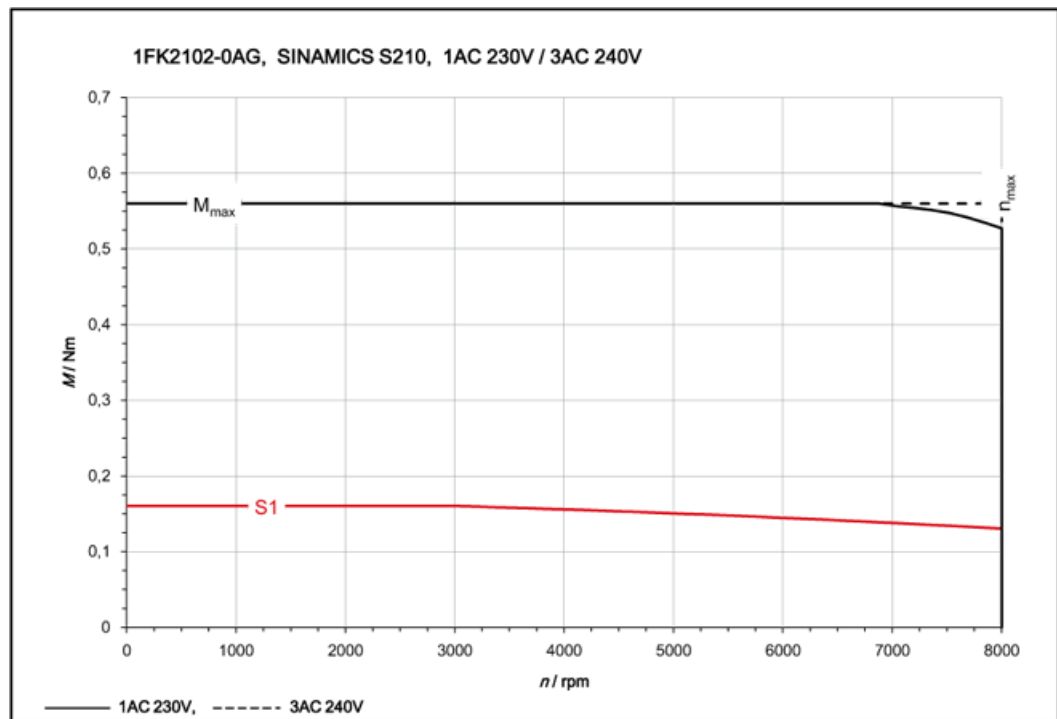

10.1.13.2 1FK2102-1AG

Technical data (in SINAMICS S210 system)	Symbol	Unit	Value
Static torque	M_0	Nm	0.32
Stall current	I_0	A	0.76
Maximum permissible speed	n_{max}	rpm	8000
Maximum torque	M_{max}	Nm	1.11
Maximum current	I_{max}	A	2.95
Thermal time constant	T_{th}	rpm	16
Rotor moment of inertia	J_{mot}	kgcm ²	0.036
Rotor moment of inertia (with brake)	$J_{mot br}$	kgcm ²	0.04
Weight	m_{mot}	kg	0.6
Weight (with brake)	$m_{mot br}$	kg	0.86
Rated data for S210 connected to 1 AC 230 V, 3 AC 240 V			
Rated speed	n_{rated}	rpm	3000
Rated torque	M_{rated}	Nm	0.32
Rated current	I_{rated}	A	0.76
Rated power	P_{rated}	kW	0.1

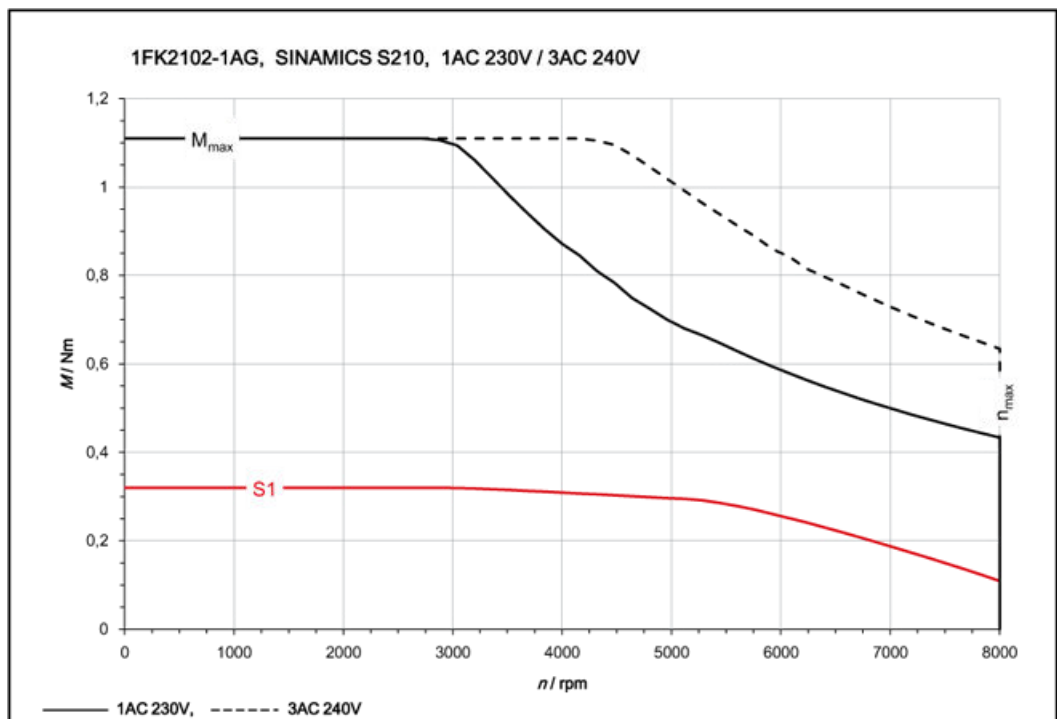

10.1.13.3 1FK2103-2AG

Technical data (in SINAMICS S210 system)	Symbol	Unit	Value
Static torque	M_0	Nm	0.64
Stall current	I_0	A	1.36
Maximum permissible speed	$n_{\max \text{ mech}}$	rpm	8000
Maximum torque	M_{\max}	Nm	1.95
Maximum current	I_{\max}	A	4.8
Thermal time constant	T_{th}	min	17
Moment of inertia	J_{mot}	kgcm ²	0.093
Moment of inertia (with brake)	$J_{\text{mot br}}$	kgcm ²	0.112
Weight	m_{mot}	kg	1.16
Weight (with brake)	$m_{\text{mot br}}$	kg	1.66
Rated data for S210 connected to 1 AC 230 V, 3 AC 240 V			
Rated speed	n_{rated}	rpm	3000
Rated torque	M_{rated}	Nm	0.64
Rated current	I_{rated}	A	1.36
Rated power	P_{rated}	kW	0.2

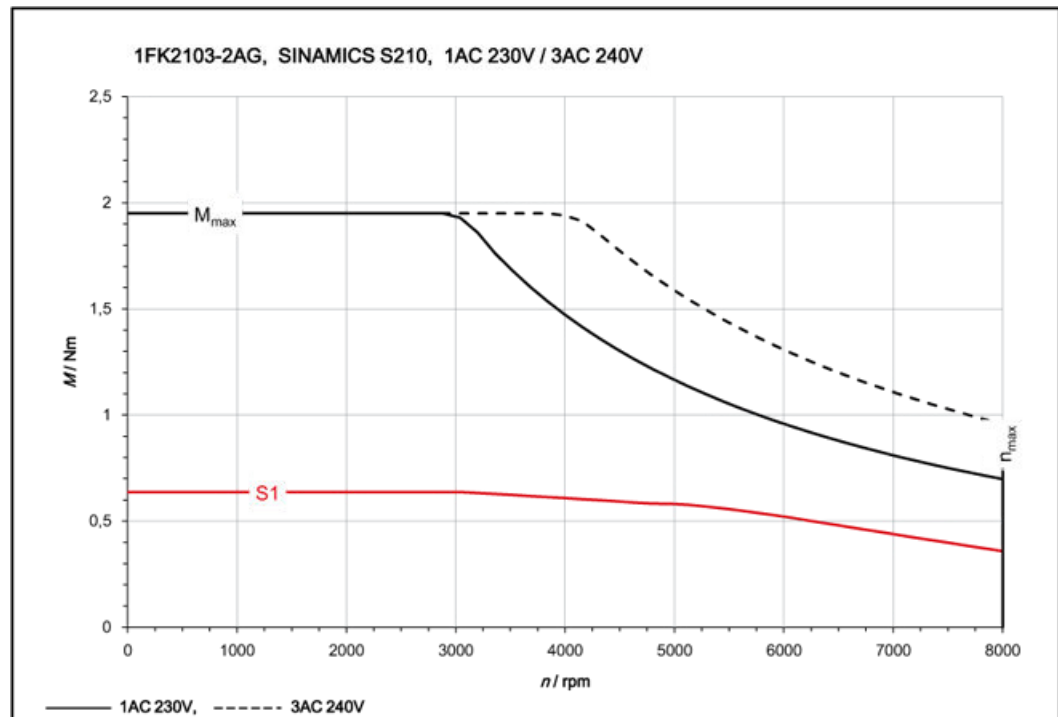

10.1.13.4 1FK2103-4AG

Technical data (in SINAMICS S210 system)	Symbol	Unit	Value
Static torque	M_0	Nm	1.27
Stall current	I_0	A	2.4
Maximum permissible speed	$n_{max\ mech}$	rpm	7300
Maximum torque	M_{max}	Nm	4.05
Maximum current	I_{max}	A	8.7
Thermal time constant	T_{th}	min	21
Moment of inertia	J_{mot}	kgcm ²	0.139
Moment of inertia (with brake)	$J_{mot\ br}$	kgcm ²	0.158
Weight	m_{mot}	kg	1.63
Weight (with brake)	$m_{mot\ br}$	kg	2.15
Rated data for S210 connected to 1 AC 230 V, 3 AC 240 V			
Rated speed	n_{rated}	rpm	3000
Rated torque	M_{rated}	Nm	1.27
Rated current	I_{rated}	A	2.4
Rated power	P_{rated}	kW	0.4

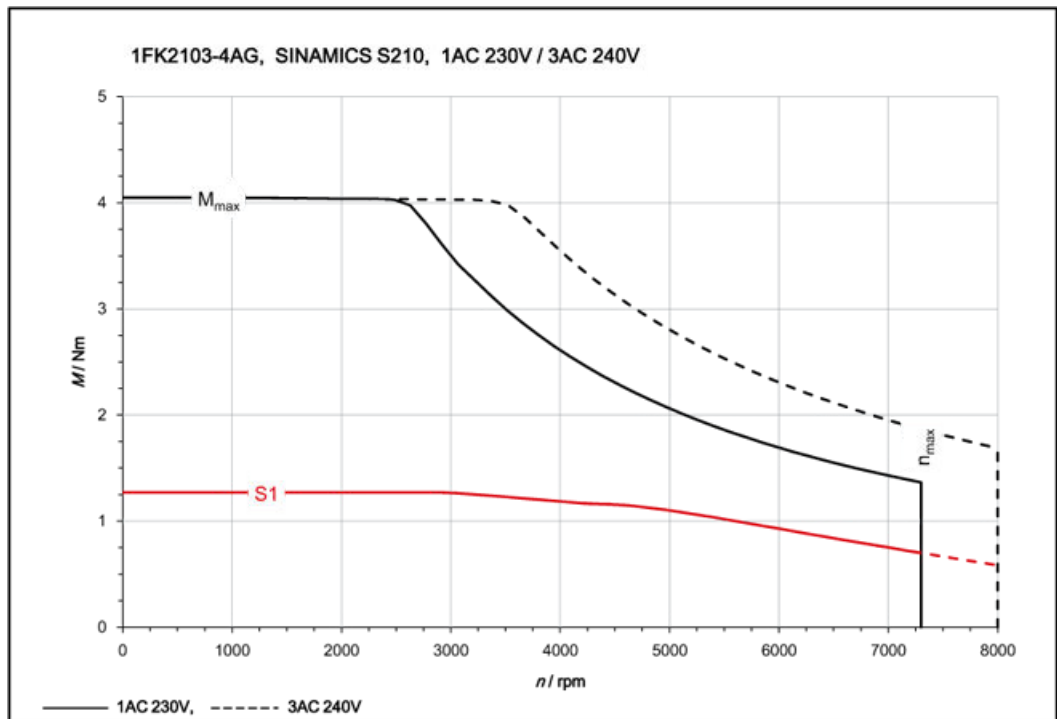

10.1.13.5 1FK2104-4AK

Technical data (in SINAMICS S210 system)	Symbol	Unit	Value
Static torque	M_0	Nm	1.27
Stall current	I_0	A	2.4
Maximum permissible speed	n_{max}	rpm	7500
Maximum torque	M_{max}	Nm	3.85
Maximum current	I_{max}	A	8.7
Thermal time constant	T_{th}	rpm	33
Rotor moment of inertia	J_{mot}	kgcm ²	0.35
Rotor moment of inertia (with brake)	$J_{mot\ br}$	kgcm ²	0.43
Weight	m_{mot}	kg	2.05
Weight (with brake)	$m_{mot\ br}$	kg	2.9
Rated data for S210 connected to 230 V 1 AC, 240 V 3 AC			
Rated speed	n_{rated}	rpm	3000
Rated torque	M_{rated}	Nm	1.27
Rated current	I_{rated}	A	2.4
Rated power	P_{rated}	kW	0.4

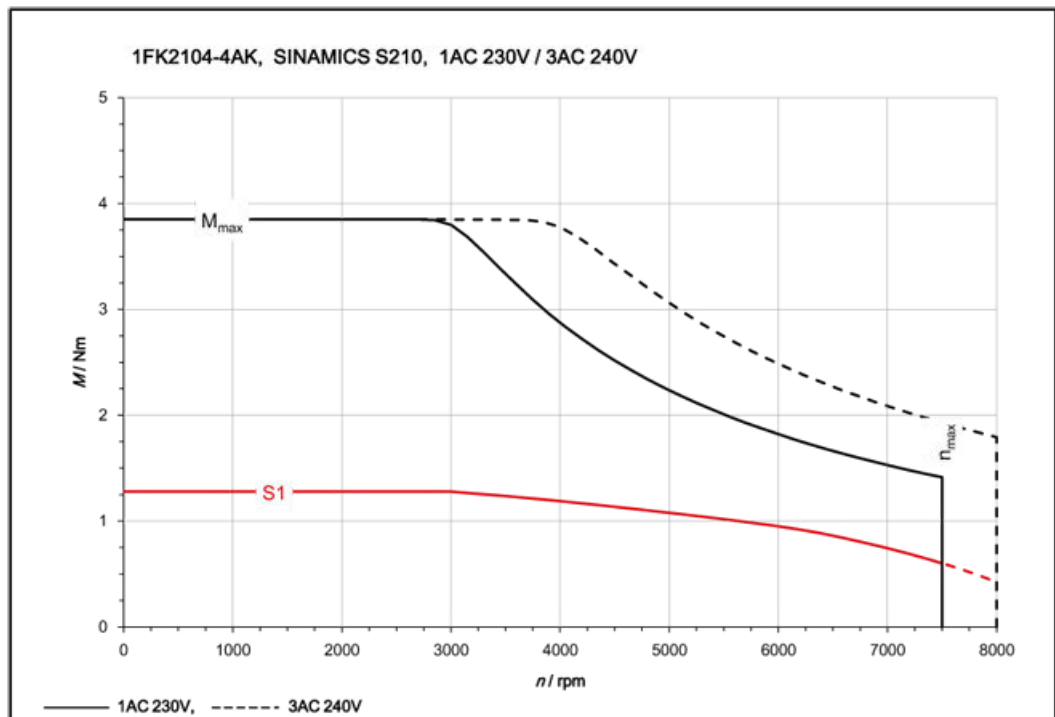

10.1.13.6 1FK2104-5AK

Technical data (in SINAMICS S210 system)	Symbol	Unit	Value
Static torque	M_0	Nm	2.4
Stall current	I_0	A	4.4
Maximum permissible speed	n_{max}	rpm	7100
Maximum torque	M_{max}	Nm	7.6
Maximum current	I_{max}	A	16
Thermal time constant	T_{th}	rpm	35
Rotor moment of inertia	J_{mot}	kgcm ²	0.56
Rotor moment of inertia (with brake)	$J_{mot br}$	kgcm ²	0.65
Weight	m_{mot}	kg	2.85
Weight (with brake)	$m_{mot br}$	kg	3.7
Rated data for S210 on 230 V 1 AC			
Rated speed	n_{rated}	rpm	3000
Rated torque	M_{rated}	Nm	2.4
Rated current	I_{rated}	A	4.4
Rated power	P_{rated}	kW	0.75

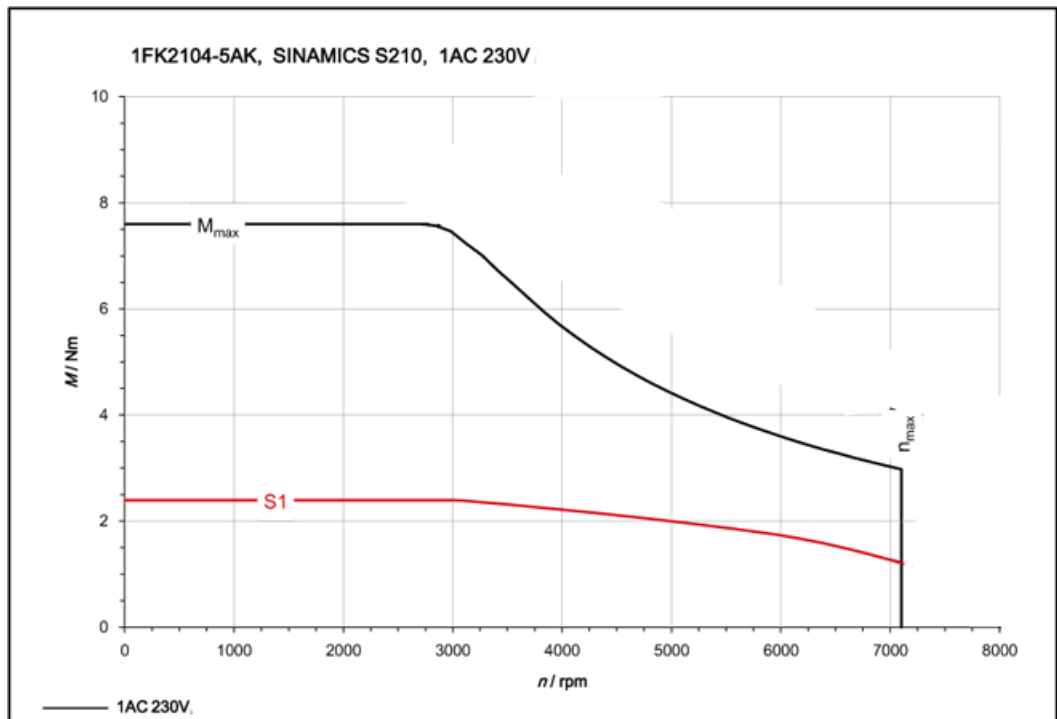

10.1.14 Technical data and characteristics 1FK2 Compact

10.1.14.1 1FK2203-2AG

Technical data (in SINAMICS S210 system)	Symbol	Unit	Value
Static torque	M_0	Nm	0.64
Stall current	I_0	A	1.38
Maximum permissible speed	n_{max}	rpm	8000
Maximum torque	M_{max}	Nm	1.85
Maximum current	I_{max}	A	4.2
Thermal time constant	T_{th}	rpm	21
Rotor moment of inertia	J_{mot}	kgcm ²	0.2
Rotor moment of inertia (with brake)	$J_{mot\ br}$	kgcm ²	0.22
Weight	m_{mot}	kg	1.1
Weight (with brake)	$m_{mot\ br}$	kg	1.6
Rated data for S210 connected to 1 AC 230 V, 3 AC 240 V			
Rated speed	n_{rated}	rpm	3000
Rated torque	M_{rated}	Nm	0.64
Rated current	I_{rated}	A	1.38
Rated power	P_{rated}	kW	0.2

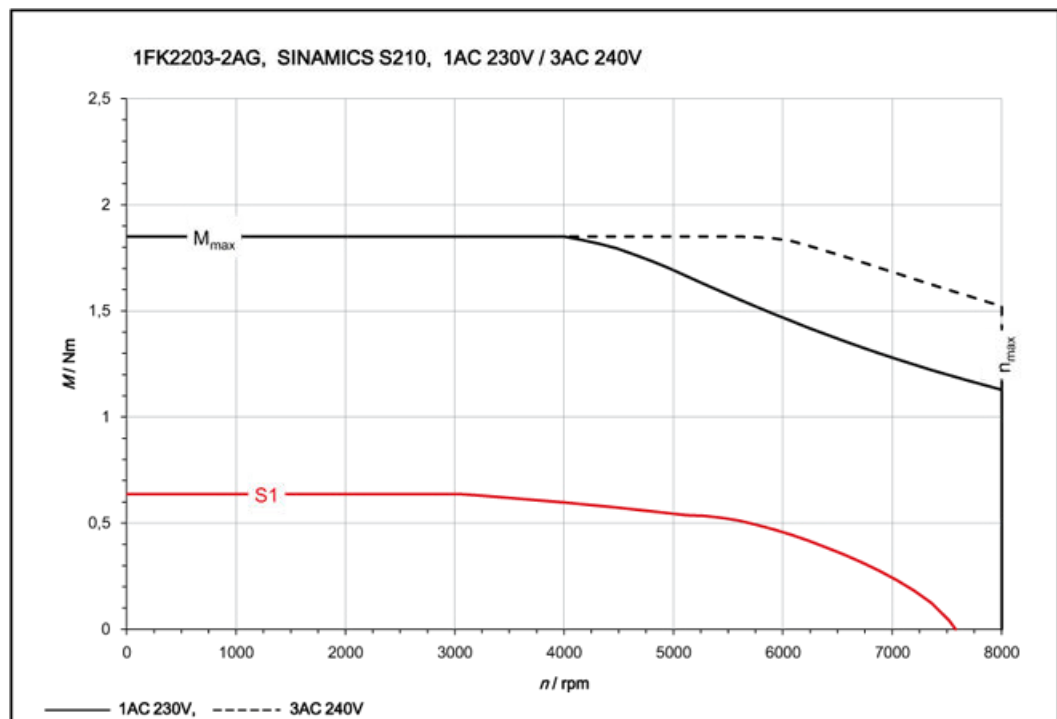

10.1.14.2 1FK2203-4AG

Technical data (in SINAMICS S210 system)	Symbol	Unit	Value
Static torque	M_0	Nm	1.27
Stall current	I_0	A	2.52
Maximum permissible speed	n_{max}	rpm	7800
Maximum torque	M_{max}	Nm	3.75
Maximum current	I_{max}	A	7.8
Thermal time constant	T_{th}	rpm	28
Rotor moment of inertia	J_{mot}	kgcm ²	0.35
Rotor moment of inertia (with brake)	$J_{mot br}$	kgcm ²	0.37
Weight	m_{mot}	kg	1.57
Weight (with brake)	$m_{mot br}$	kg	2.1
Rated data for S210 connected to 1 AC 230 V, 3 AC 240 V			
Rated speed	n_{rated}	rpm	3000
Rated torque	M_{rated}	Nm	1.27
Rated current	I_{rated}	A	2.52
Rated power	P_{rated}	kW	0.4

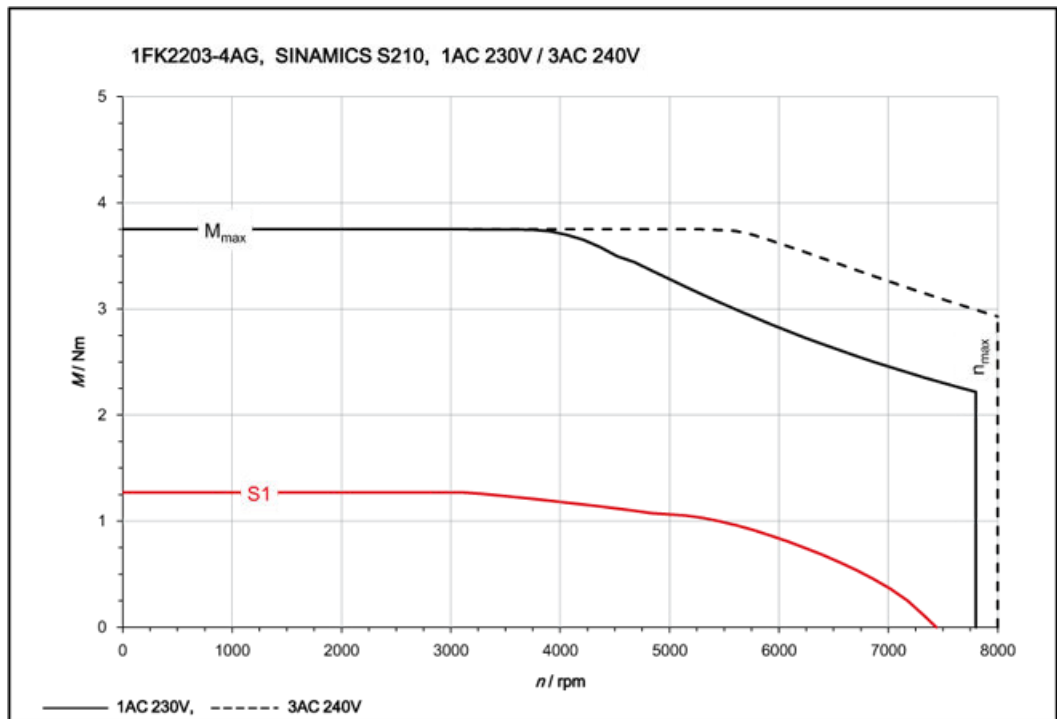

10.1.14.3 1FK2204-5AF

Technical data (in SINAMICS S210 system)	Symbol	Unit	Value
Static torque	M_0	Nm	2.4
Stall current	I_0	A	2.25
Maximum permissible speed	n_{max}	rpm	7500
Maximum torque	M_{max}	Nm	7.1
Maximum current	I_{max}	A	7.1
Thermal time constant	T_{th}	rpm	29
Rotor moment of inertia	J_{mot}	kgcm ²	1.23
Rotor moment of inertia (with brake)	$J_{mot br}$	kgcm ²	1.31
Weight	m_{mot}	kg	2.9
Weight (with brake)	$m_{mot br}$	kg	3.75
Rated data for S210 connected to 3 AC 400 V, 3 AC 480 V			
Rated speed	n_{rated}	rpm	3000
Rated torque	M_{rated}	Nm	2.4
Rated current	I_{rated}	A	2.25
Rated power	P_{rated}	kW	0.75

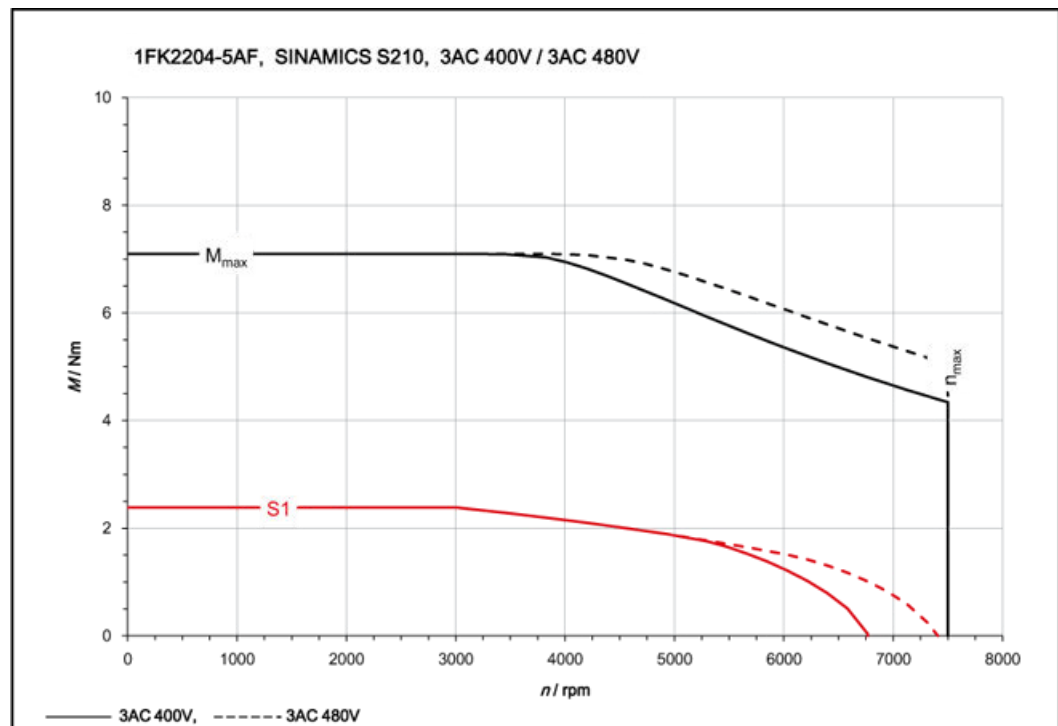

10.1.14.4 1FK2204-5AK

Technical data (in SINAMICS S210 system)	Symbol	Unit	Value
Static torque	M_0	Nm	2.4
Stall current	I_0	A	4.4
Maximum permissible speed	n_{max}	rpm	7500
Maximum torque	M_{max}	Nm	7.1
Maximum current	I_{max}	A	14.2
Thermal time constant	T_{th}	rpm	29
Rotor moment of inertia	J_{mot}	kgcm ²	1.23
Rotor moment of inertia (with brake)	$J_{mot br}$	kgcm ²	1.31
Weight	m_{mot}	kg	2.9
Weight (with brake)	$m_{mot br}$	kg	3.75
Rated data for S210 on 230 V 1 AC			
Rated speed	n_{rated}	rpm	3000
Rated torque	M_{rated}	Nm	2.4
Rated current	I_{rated}	A	4.4
Rated power	P_{rated}	kW	0.75

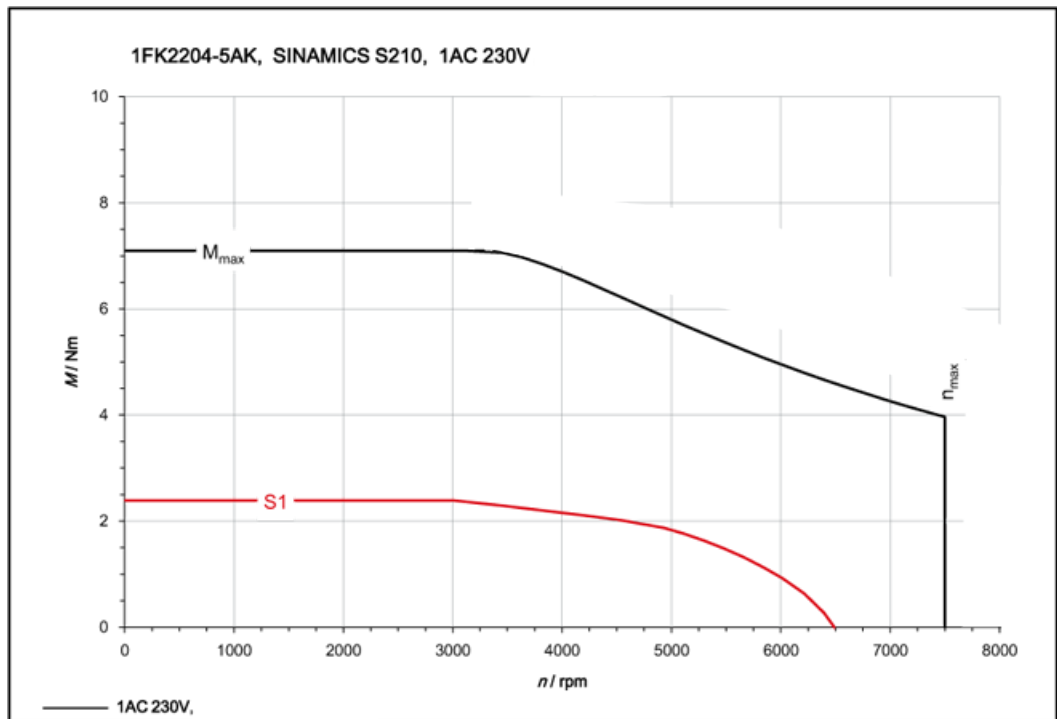

10.1.14.5 1FK2204-6AF

Technical data (in SINAMICS S210 system)	Symbol	Unit	Value
Static torque	M_0	Nm	3.2
Stall current	I_0	A	3
Maximum permissible speed	n_{max}	rpm	7600
Maximum torque	M_{max}	Nm	9.5
Maximum current	I_{max}	A	9.9
Thermal time constant	T_{th}	rpm	35
Rotor moment of inertia	J_{mot}	kgcm ²	1.61
Rotor moment of inertia (with brake)	$J_{mot br}$	kgcm ²	1.69
Weight	m_{mot}	kg	3.5
Weight (with brake)	$m_{mot br}$	kg	4.35
Rated data for S210 connected to 3 AC 400 V, 3 AC 480 V			
Rated speed	n_{rated}	rpm	3000
Rated torque	M_{rated}	Nm	3.2
Rated current	I_{rated}	A	3
Rated power	P_{rated}	kW	1

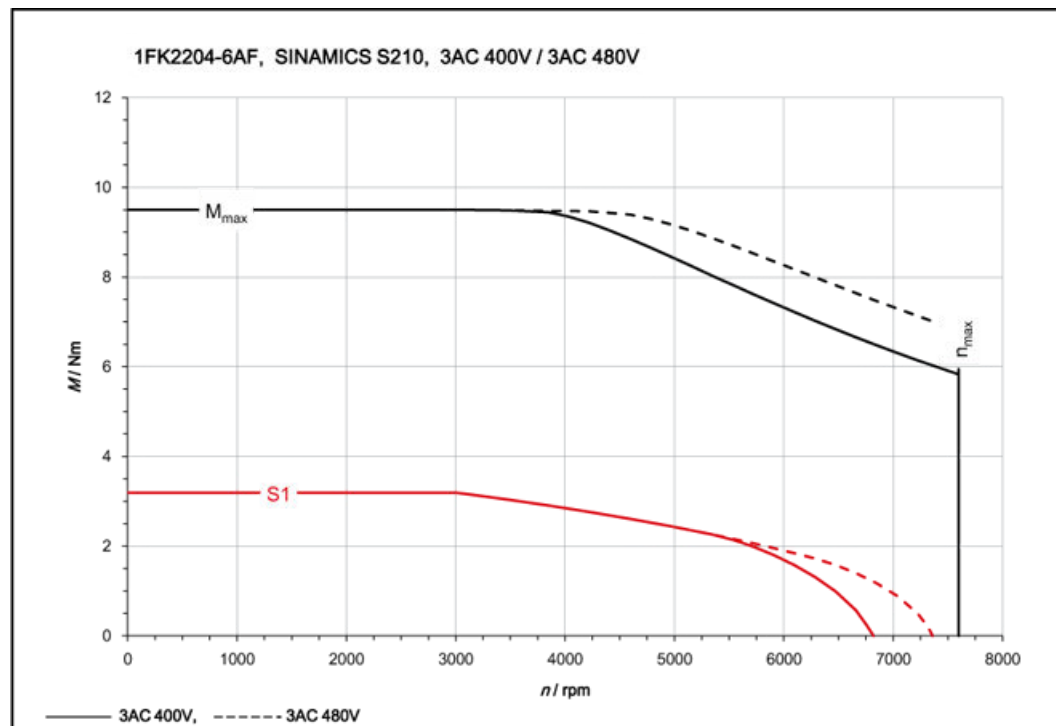

10.2 Technical specifications of the converter

Overload capability and shutdown behavior of the converter

For a short time, the servomotors are able to withstand maximum current.

The values for the individual motors can be found in the following sections:



Technical data and characteristics 1FK2 High Dynamic (Page 296).

Technical data and characteristics 1FK2 Compact (Page 303).

When the load exceeds the rated current, the thermal protection of the converter starts and switches the motor off in accordance with the overload characteristics shown below.

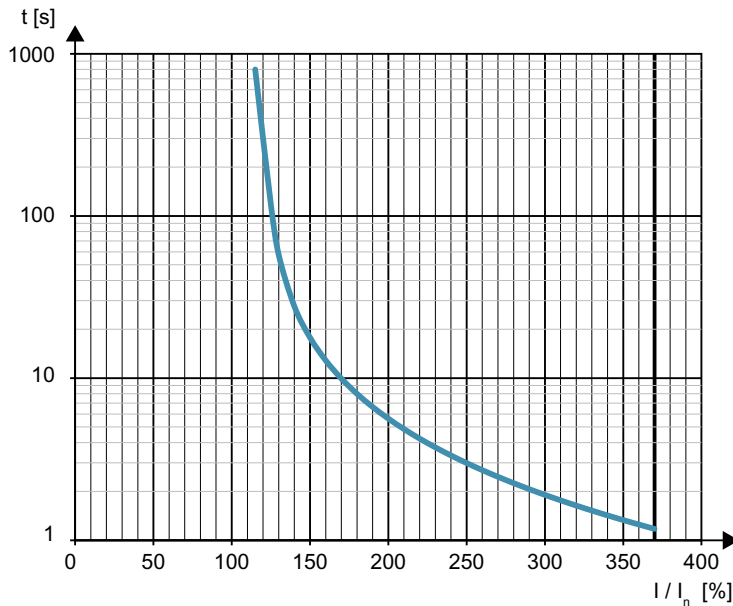

Figure 10-13 Overload characteristic for shutting down the motor for converters with 1 AC line connection

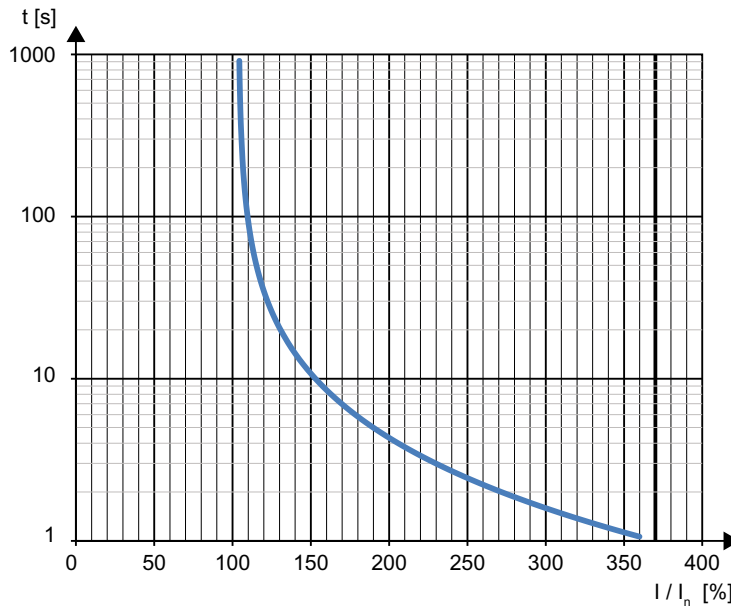

Figure 10-14 Overload characteristic for shutting down the motor for converters with 3 AC line connection

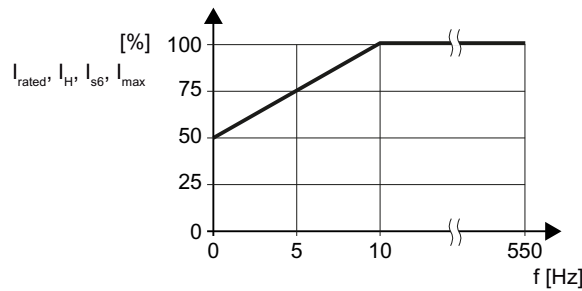

Figure 10-15 Permitted output current at low frequencies

TIA selection tool (TST)

Use the TIA selection tool (TST) to configure a converter-motor combination, adapted to your specific machine

 TIA selection tool (<https://mall.industry.siemens.com/spice/TSTWeb/#/Start/>)

10.2.1 Electromagnetic compatibility according to EN61800-3

Converters are equipment used on a professional basis, deployed in certain areas of business and industry – and are not operated in the general public domain.



For an EMC-compliant installation, observe the information provided in the Configuration Manual: EMC installation guideline (<http://support.automation.siemens.com/WW/view/en/60612658>).

The devices described there are intended for operation in the first and second environments.

The drive system must be installed by appropriately qualified personnel in compliance with EMC regulations - and the installation notes provided in the manual.

The permissible cable lengths for the various EMC categories are listed in the following section:



Cable lengths (Page 148).

10.2.2 Permissible ambient conditions

Property	Version
Ambient conditions for transport in the transport packaging	
Climatic ambient conditions	-40 °C ... +70 °C, according to Class 2K4 to EN 60721-3-2 maximum humidity 95 % at 40 °C
Mechanical ambient conditions	Shock and vibration permissible according to 2M3 to EN 60721-3-2
Protection against chemical substances	Protected according to Class 2C2 to EN 60721-3-2
Biological environmental conditions	Suitable according to Class 2B2 to EN 60721-3-2
Ambient conditions for long-term storage in the product packaging	
Climatic ambient conditions ¹⁾	-25 °C ... +55 °C, according to Class 1K4 to EN 60721-3-1
Protection against chemical substances	Protected according to Class 1C2 to EN 60721-3-1
Biological environmental conditions	Suitable according to Class 1B2 to EN 60721-3-1
Ambient conditions in operation	
Installation altitude	<ul style="list-style-type: none"> • Up to 1000 m above sea level without restrictions • Up to 4000 m, restrictions, see the following table
Climatic ambient conditions	<ul style="list-style-type: none"> • Temperature range: 0 °C ... +50 °C • Relative humidity: 5 ... 95%, condensation not permitted • Oil mist, salt mist, ice formation, condensation, dripping water, spraying water, splashing water and water jets are not permitted <p>Increased ruggedness regarding temperature range and relative humidity; therefore better than 3K3 according to EN 60721-3-3</p>
Mechanical ambient conditions	<ul style="list-style-type: none"> • Vibration levels permissible according to Class 3M2 to EN 60721-3-3 Vibration test in operation according to IEC 60068-2-6 Test Fc (sinusoidal) <ul style="list-style-type: none"> – 9 Hz ... 18 Hz: 1.5 mm deflection amplitude – 18 Hz ... 200 Hz: 2 g acceleration amplitude – 10 frequency cycles per axis • Shock permissible according to Class 3M2 to EN 60721-3-3 Shock test in operation according to IEC 60068-2-27 Test Ea (half sinusoidal) <ul style="list-style-type: none"> – 5 g peak acceleration – 30 ms duration – 3 shocks in all three axes in both directions
Protection against chemical substances	Protected according to 3C2 to EN 60721-3-3
Biological environmental conditions	Suitable according to 3B2 to EN 60721-3-3
Pollution	Suitable for environments with degree of pollution 2 according to EN 61800-5-1

10.2 Technical specifications of the converter

Table 10-4 Maximum permissible output current depending on the installation altitude and ambient temperature

Installation altitude [m] up to	Ambient temperature [° C]		
	50	45	40
	Output current [%]		
1000	100		
2000	90	100	
3000	80	90	100
4000	70	80	90

An isolating transformer is required above an installation altitude of 2000 m.

10.2.3 General data

Property	Version
Line voltage	1 AC 200 V ... 1 AC 240 V, $\pm 10\%$ 3 AC 200 V ... 240 V, $\pm 10\%$ 3 AC 380 V ... 480 V, $\pm 10\%$
Output voltage	3 AC 0 V ... 0.95 x input voltage
Input frequency	50 Hz ... 60 Hz, $\pm 10\%$
Output frequency	0 ... 550 Hz
Relative supply short-circuit power	RSC ≥ 25
Power factor λ	typ. 0.6 without line reactor for $U_k \geq 1\%$ typ. 0.85 with line reactor for $U_k < 1\%$
Overvoltage category to IEC/EN 61800-5-1	<ul style="list-style-type: none"> Up to 2000 m: The converter insulation is designed for surge voltages of overvoltage category III. More than 2000 m: The surge voltages must be limited to values of overvoltage category II, using an isolation transformer, for example.
Pulse frequency	8 kHz
Short-circuit current rating (SCCR) and branch protection	≤ 65 kA rms Branch protection and short-circuit strength according to UL and IEC  Protective devices (https://support.industry.siemens.com/cs/ww/en/view/109748999)
Degree of protection according to EN 60529	IP20 Must be installed in a control cabinet
Electronics power supply	24 V DC, -15% ... $+20\%$, (PELV or SELV) with a permissible interference radiation of 20 V/m <ul style="list-style-type: none"> Converters with 1 AC line connection <ul style="list-style-type: none"> $I_{max} = 2$ A for 1FK2 motors with brake (high-performance brake 500 ms) $I_{max} = 1.6$ A for standard motors with brake $I_{max} = 1.1$ A for motors without brake Converter with 3 AC line connection: <ul style="list-style-type: none"> $I_{max} = 3.25$ A for 1FK2 motors with brake (high-performance brake 500 ms) $I_{max} = 2.4$ A for standard motors with brake $I_{max} = 1.2$ A for motors without brake
Control mode	Servo control
Protection functions	Ground fault protection, output short-circuit protection, overvoltage/undervoltage protection, I2t detection, IGBT overtemperature protection

Table 10-5 Technical data of the digital inputs

Type	High-speed digital inputs for probe or reference marks	Failsafe Digital Input (F-DI)	Digital input for monitoring the temperature of an external braking resistor
Number	2 (DI 0, DI 1)	1 (DI 2 and DI 3)	1 (DI 4)
• Low level	-30 V ... +5 V and ≤ 2 mA	-30 V ... +5 V and ≤ 2 mA	-30 V ... +5 V and ≤ 2 mA
• High level	15 V ... 30 V	15 V ... 30 V	15 V ... 30 V
• Current consumption	6 mA	5 mA	6 mA
• Delay time, typ. L → H	5 μ s	50 μ s	5 μ s
• Delay time, typ. H → L	50 μ s	100 μ s	50 μ s
• Electrical isolation	No	Yes	No
Conductor cross section, max.	1.5 mm ²	1.5 mm ²	1.5 mm ²

10.2.4 Specific data of the converter with 1 AC line connection

Table 10-6 FSA, 1 AC

Article no. with filter	6SL3210-5HB10-1UF0	6SL3210-5HB10-2UF0
Rated output current	0.8 A	1.36 A
Maximum output current	3.1 A	4.8 A
Rated power	100 W	200 W
Rated input current	1.4 A	2.7 A
Inrush current	8 A	8 A
Fuse according to IEC	3NA3 801 (6 A)	3NA3 801 (6 A)
Fuse according to UL, class J	6 A	6 A
Cooling air requirement	Convection cooling without fan	Convection cooling without fan
Weight	1.1 kg	1.1 kg

Table 10-7 FSB, 1 AC

Article no. with filter	6SL3210-5HB10-4UF0
Rated output current	2.4 A
Maximum output current	8.7 A
Rated power	400 W
Rated input current	5 A
Inrush current	8 A
Fuse according to IEC	3NA3 803 (10 A)
Fuse according to UL, class J	10 A
Cooling air requirement	Convection cooling without fan
Weight	1.2 kg

Table 10-8 FSC, 1 AC

Article no. with filter	6SL3210-5HB10-8UF0
Rated output current	4.4 A
Maximum output current	16 A
Rated power	750 W
Rated input current	9.3 A
Inrush current	8 A
Fuse according to IEC	3NA3 805 (16 A)
Fuse according to UL, class J	20 A
Cooling air requirement	Convection cooling without fan
Weight	1.9 kg

10.2.5 Specific data of the converter with 3 AC line connection

Table 10-9 FSA, 3 AC 400 V

Article no. with filter	6SL3210-5HE10-4UF0	6SL3210-5HE10-8UF0
Rated output current	1.2 A	2.3 A
Maximum output current	4.2 A	7.6 A
Rated power	0.4 kW	0.75 kW
Rated input current at 400 V	1.5 A	2.9 A
Rated input current at 240 V	2 A	3.8 A
Inrush current	4.8 A	4.8 A
Fuse according to IEC	3NA3 805 (16 A)	3NA3 805 (16 A)
Fuse according to UL, class J	15 A	15 A
Cooling	Integrated fan	Integrated fan
Weight	2.1 kg	2.1 kg

Table 10-10 FSA, 3 AC 400 V

Article no. with filter	6SL3210-5HE11-0UF0
Rated output current	3 A
Maximum output current	10.9 A
Rated power	1 kW
Rated input current at 400 V	3.8 A
Rated input current at 240 V	5 A
Inrush current	4.8 A
Fuse according to IEC	3NA3 805 (16 A)
Fuse according to UL, class J	15 A
Cooling air requirement	Integrated fan
Weight	2.1 kg

Table 10-11 FSB, 3 AC 400 V - preliminary data

Article no. with filter	6SL3210-5HE11-5UF0	6SL3210-5HE12-0UF0
Rated output current	5 A	7 A
Maximum output current	19 A	24 A
Rated power	1.5 kW	2 kW
Rated input current at 400 V	4.8 A	6.7 A
Rated input current at 240 V	7.8 A	11 A
Inrush current	11.3 A	11.3 A
Fuse according to IEC	3NA3 812 (32 A)	3NA3 812 (32 A)
Fuse according to UL, class J	30 A	30 A
Cooling air requirement	Integrated fan	Integrated fan
Weight	3.2 kg	3.2 kg

Table 10-12 FSC, 3 AC 400 V - preliminary data

Article no. with filter	6SL3210-5HE13-5UF0	6SL3210-5HE15-0UF0
Rated output current	9 A	12 A
Maximum output current	30 A	40 A
Rated power	3.5 kW	5 kW
Rated input current at 400 V	11.3 A	15 A
Rated input current at 240 V	A	A
Inrush current	29.1 A	29.1 A
Fuse according to IEC Fuse according to UL, class J		
Cooling air requirement	Integrated fan	Integrated fan
Weight	kg	kg

Table 10-13 FSC, 3 AC 400 V - preliminary data



Article no. with filter	6SL3210-5HE17-0UF0
Rated output current	15 A
Maximum output current	50 A
Rated power	7 kW
Rated input current at 400 V	18.8 A
Rated input current at 240 V	A
Inrush current	29.1 A
Fuse according to IEC Fuse according to UL, class J	
Cooling air requirement	Integrated fan
Weight	kg

10.3 Technical data and properties of the connection system

MOTION-CONNECT connection cables between the motor and the converter

The following technical data applies to the MOTION-CONNECT OCC cables.

Table 10-14 MOTION-CONNECT OCC cable with SPEED-CONNECT connector

Designation and use	Cable type	Connector size	Outer diameter	Minimum bending radius, static	For connection to motor	Article number ¹⁾
			D_{max} / mm	R / mm		
Motor connection cable MC500 OCC for predominantly fixed installation		M12	9.7	23.5	1FK2□02 1FK2□03	6FX5002-8QN04-□□□□
		M17	10.5	25.5	1FK2□04	6FX5002-8QN08-□□□□
		M23	12.7	31	1FK2□06 1FK2□08 1FK2□10	6FX5002-8QN11-□□□□
Motor connection cable MC800 OCC for use in a cable carrier		M12	9.7	28.2	1FK2□02 1FK2□03	6FX8002-8QN04-□□□□
		M17	10.5	30.6	1FK2□04	6FX8002-8QN08-□□□□
		M23	12.7	37.2	1FK2□06 1FK2□08 1FK2□10	6FX8002-8QN11-□□□□
Extension cable MC500 OCC for predominantly fixed installation		M12	9.7	23.5	1FK2□02 1FK2□03	6FX5002-8QE04-□□□□
		M17	10.5	25.5	1FK2□04	6FX5002-8QE08-□□□□
		M23	12.7	31	1FK2□06 1FK2□08 1FK2□10	6FX5002-8QE11-□□□□
Extension cable MC800 OCC for use in a cable carrier		M12	9.7	28.2	1FK2□02 1FK2□03	6FX8002-8QE04-□□□□
		M17	10.5	30.6	1FK2□04	6FX8002-8QE08-□□□□
		M23	12.7	37.2	1FK2□06 1FK2□08 1FK2□10	6FX8002-8QE11-□□□□

¹⁾ The last 4 positions (□□□□) define the cable length corresponding to the length code.

The length code can be found in Chapter:

 Connection cables between the motor and the converter (Page 336)

Technical data and notes for cable carrier use with MC800 PLUS

Note

You require an MC800 PLUS cable to connect the motor using a cable carrier.

- When inserting prefabricated cables in the cable carrier, do not pull the connector, as this may damage the strain relief or cable clamping.

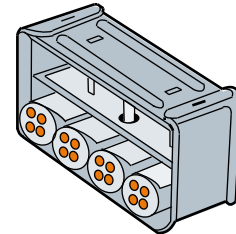

Strain relief in a cable carrier

- Lay the cables loosely in the carrier. They must be free to move. The cables must be free to move in particular in the bending radii of the carrier. Observe the specified minimal bending radii.

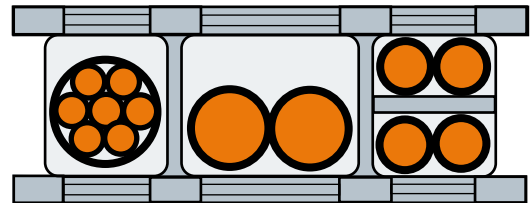

Cable routed in a cable carrier

- The cable fixings must be attached at both ends at an appropriate distance away from the end points of the moving parts in a dead zone.

When laying cables, comply with the instructions given by the cable carrier manufacturer.

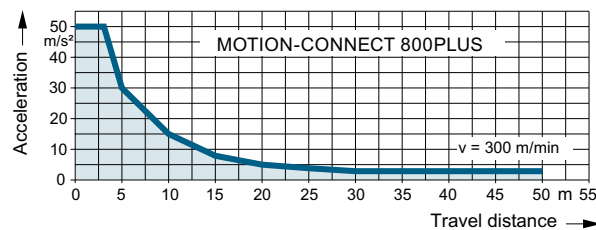

Figure 10-16 Permissible acceleration levels for MOTION-CONNECT 800 PLUS cables

Note

Additional fixing of the cable

If between the cable strain relief on the cable carrier and the terminal at the motor, part of the cable is hanging loose or is not routed, we recommend that the cable is additionally fixed for vibration load and with horizontal or vertical cable entries.

- Also fix the cable where the motor is fixed so that machine vibrations are not transferred to the connector.

Dimension drawings

11.1 Dimension drawings of motor

Dimension drawing 1FK2, shaft height 20

All dimensions in mm (inches).

1FK2□02

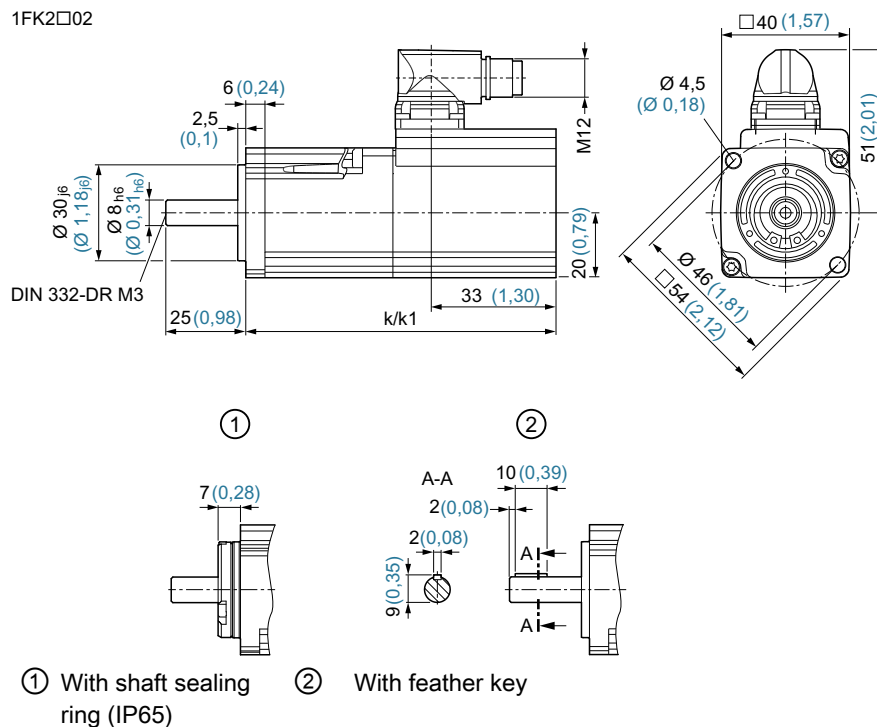
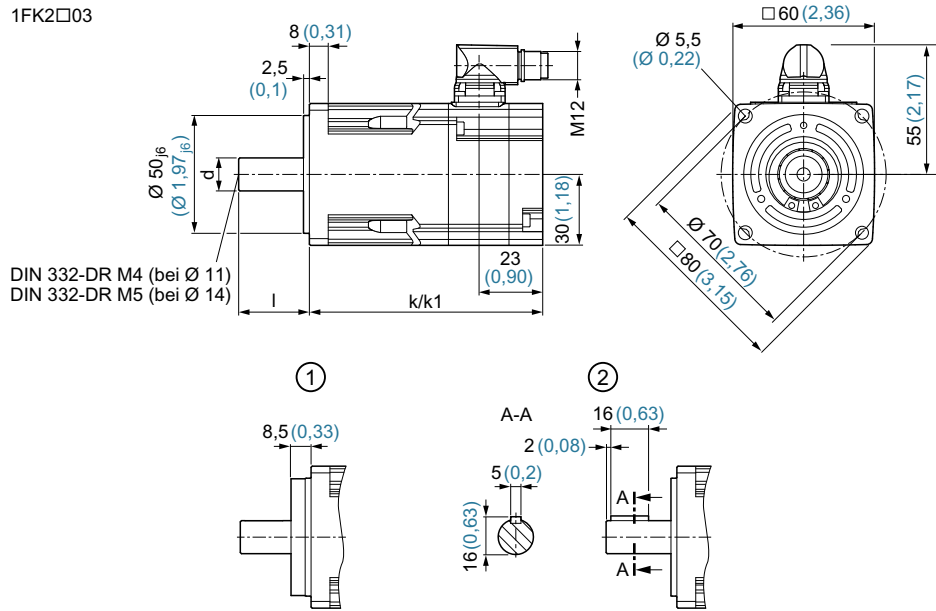

Figure 11-1 Dimension drawing 1FK2102

SIMOTICS S-1FK2 shaft height 20	Dimensions	
	Without brake	With brake
	DIN k	k1
1FK2102-0A□ (50 W)	90 (3.54)	121 (4.76)
1FK2102-1A□ (100 W)	106 (4.17)	137 (5.39)

Dimension drawing 1FK2, shaft height 30

All dimensions in mm (inches).



- ① With shaft seal- ing ring (IP65)
- ② With feather key

Figure 11-2 Dimension drawing 1FK2□03

SIMOTICS S-1FK2 shaft height 30	Dimensions						
		Without brake	With brake	Shaft 14 x 30 mm		Shaft 11 x 23 mm	
	DIN	k	k1	d	l	d	l
IEC	LB	LB1	D	L	D	L	
1FK2□03-2A□□□-0□□□ (200 W), plain shaft	99 (3.9)	131 (5.16)	14 _{h6} (0.55 _{h6})	30 (1.18)		11 _{k6} (0.43 _{k6})	23 (0.91)
1FK2□03-2A□□□-1□□ □(200 W), shaft with feather key							
1FK2□03-2A□□□-2□□ □(200 W), plain shaft							
1FK2□03-4A□□□-0□□□ (400 W), plain shaft	123 (4.84)	155 (6.10)	14 _{h6} (0.55 _{h6})	30 (1.18)		11 _{k6} (0.43 _{k6})	23 (0.91)
1FK2□03-4A□□□-1□□ □(400 W), shaft with feather key							
1FK2□03-4A□□□-2□□ □(400 W), plain shaft							

Dimension drawing 1FK2, shaft height 40

All dimensions in mm (inches).

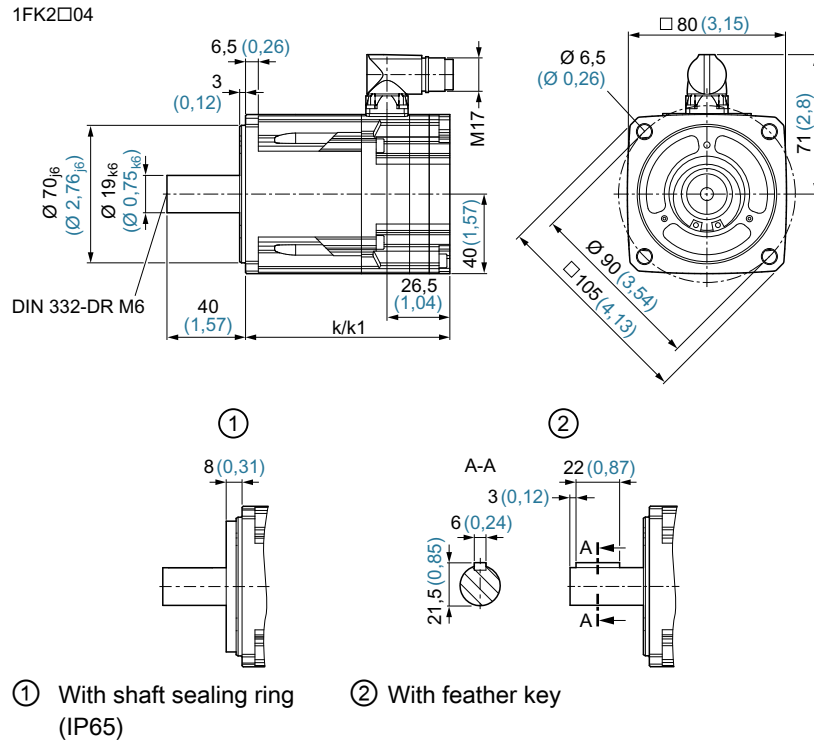

Figure 11-3 Dimension drawing 1FK2□04

SIMOTICS S-1FK2 shaft height 40	Dimensions	
	Without brake	With brake
	DIN k	k1
1FK2□04-4A□ (400 W)	98 (3.85)	142 (5.59)
1FK2□04-5A□ (750 W)	126 (4.96)	170 (6.69)
1FK2□04-6A□ (1000 W)	144 (5.57)	188 (7.40)

Dimension drawing 1FK2, shaft height 60 with M17 connector

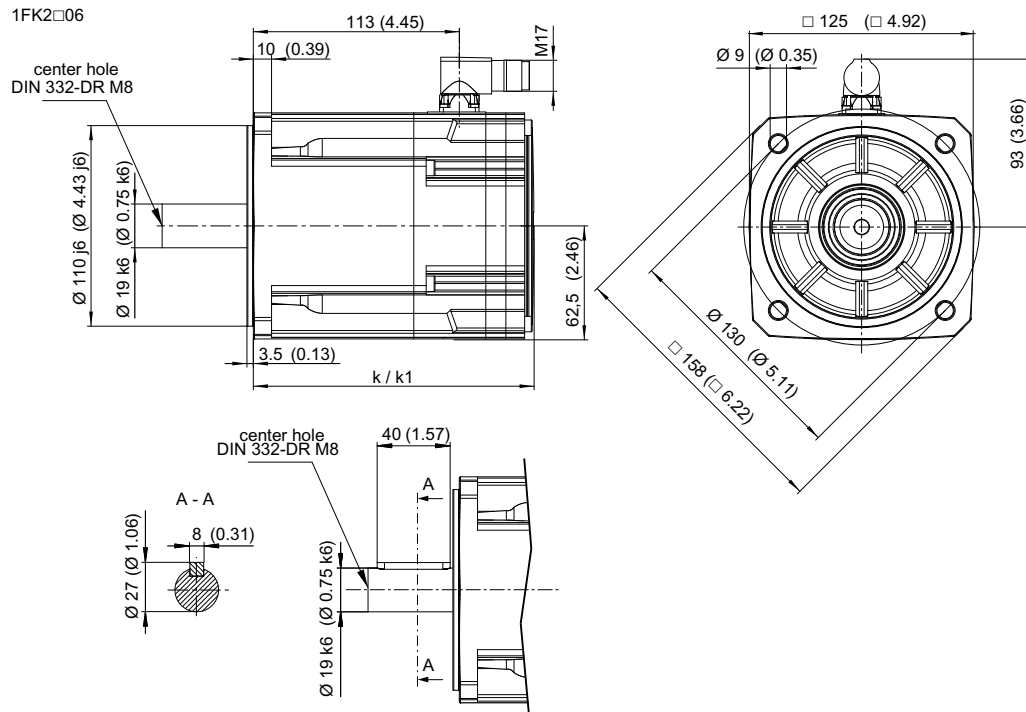

Figure 11-4 Dimension drawing_1FK2206-2AF00-0SA0

SIMOTICS S-1FK2 shaft height 60	Dimensions	
	Without brake	With brake
	DIN	k1
	IEC	LB1
1FK2206-2AF00-0SA0		154 (6.06)

Dimension drawing 1FK2, shaft height 60 with M23 connector

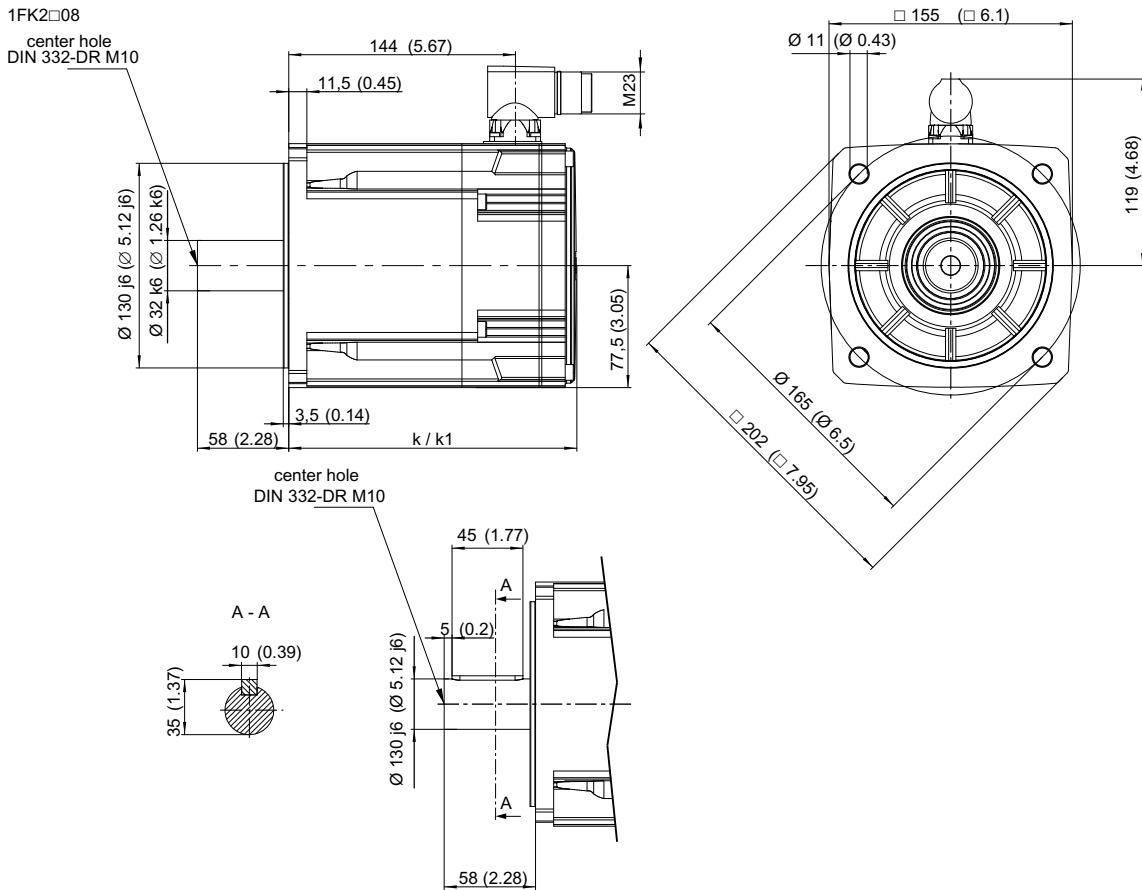

Figure 11-5 Dimension drawing_1FK2208-3AF00

SIMOTICS S-1FK2 shaft height 60	Dimensions		
	Without brake	With brake	
	DIN	k	k1
	IEC	LB	LB1
1FK2206-2AF00-0SA0		154 (6.06)	

Dimension drawing 1FK2, shaft height 80

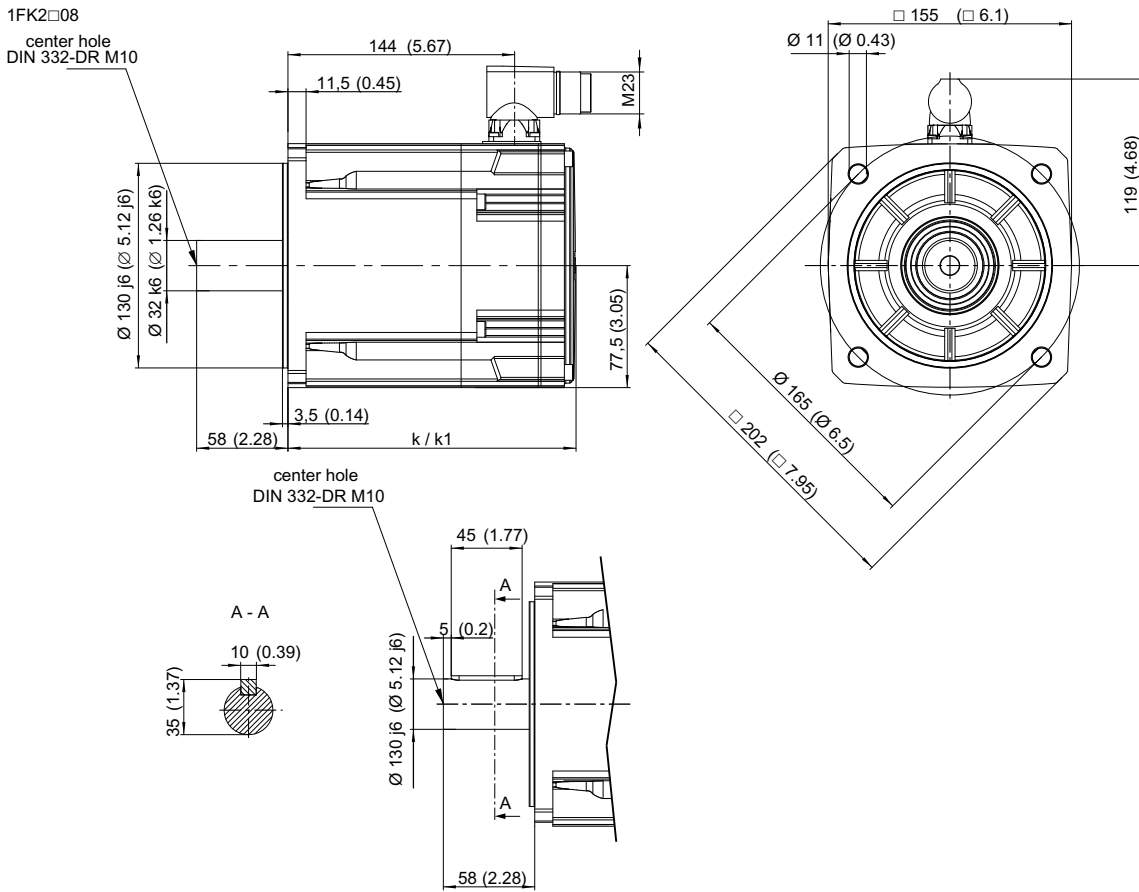

Figure 11-6 Dimension drawing_1FK2208-3AF00_OCC

SIMOTICS S-1FK2 shaft height 80	Dimensions		
	Without brake	With brake	
	DIN	k	k1
	IEC	LB	LB1
1FK2208-3AF00-0SB0		183 (7.2)	

11.2 Dimension drawings of converter

FSA with 1 AC line connection

6SL3210-5HB10-1UF0 (100 W)

6SL3210-5HB10-2UF0 (200 W)

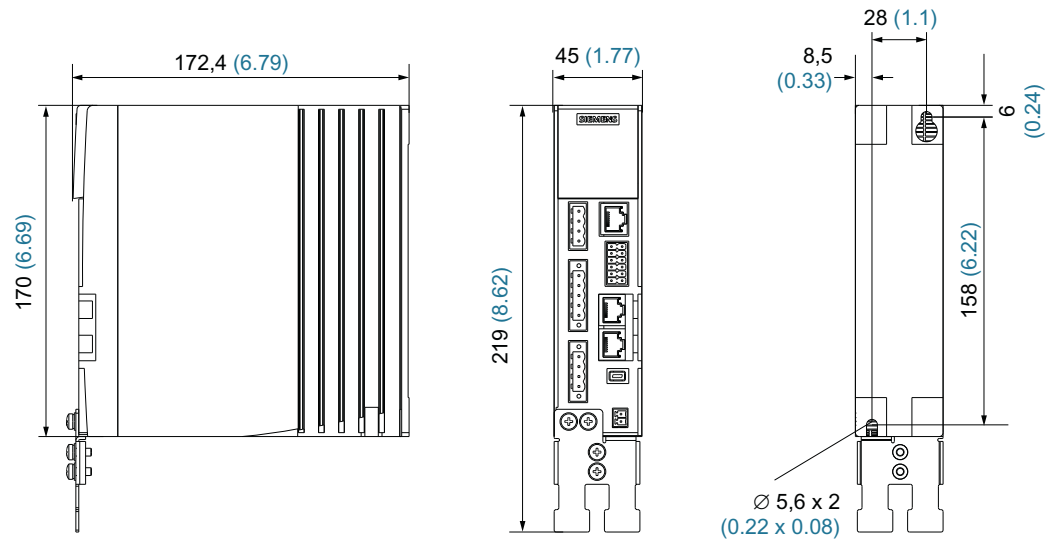

Figure 11-7 Dimension drawing SINAMICS S210 FSA, dimensions in mm (Inch)

FSB with 1 AC line connection

6SL3210-5HB10-4UF0 (400 W)

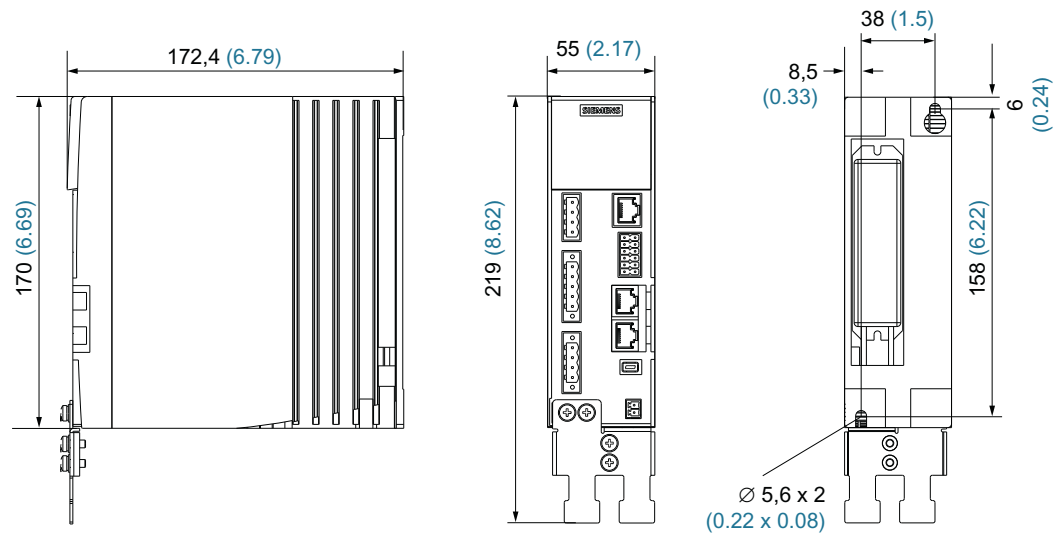

Figure 11-8 Dimension drawing SINAMICS S210 FSB, dimensions in mm (inches)

FSC with 1 AC line connection

6SL3210-5HB10-8UF0 (750 W)

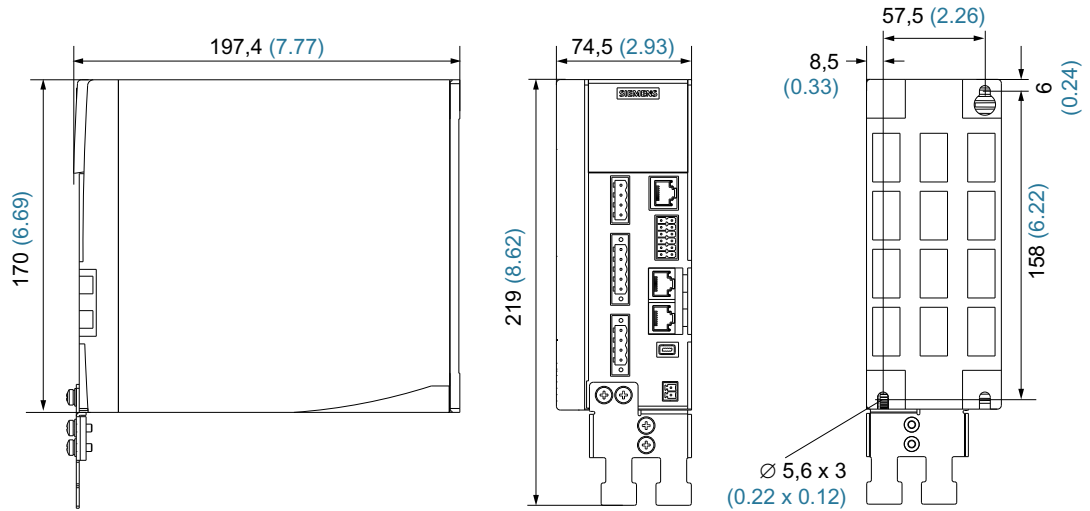
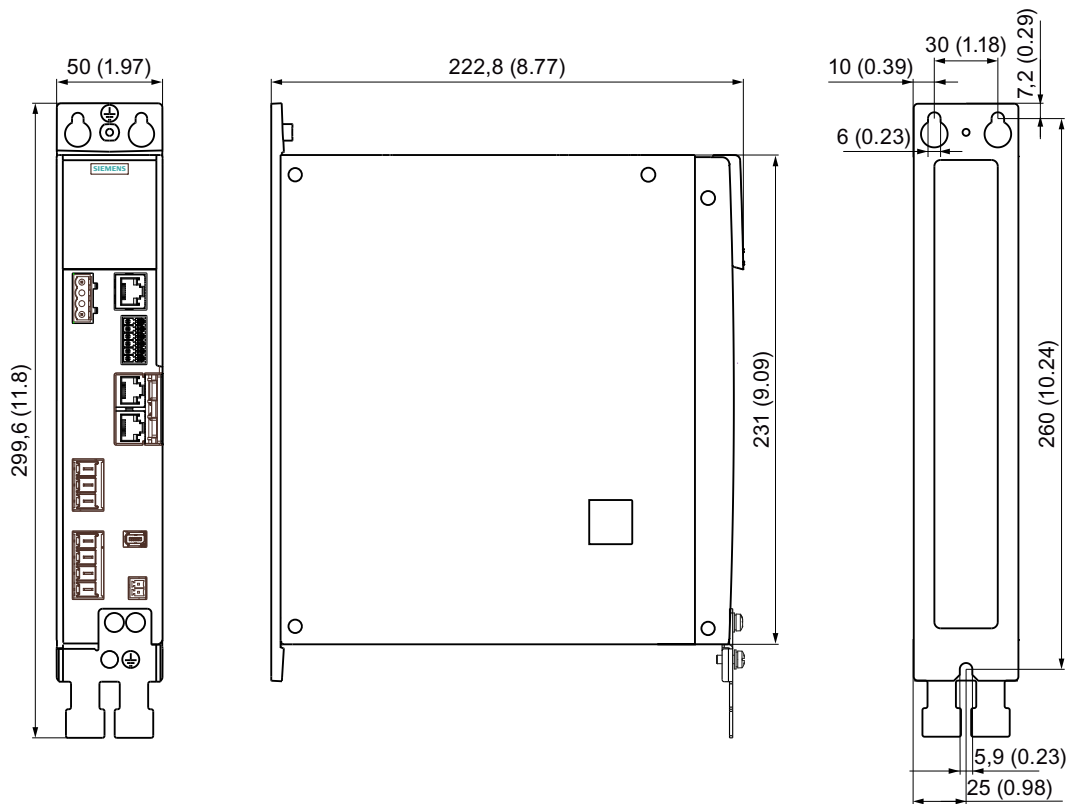
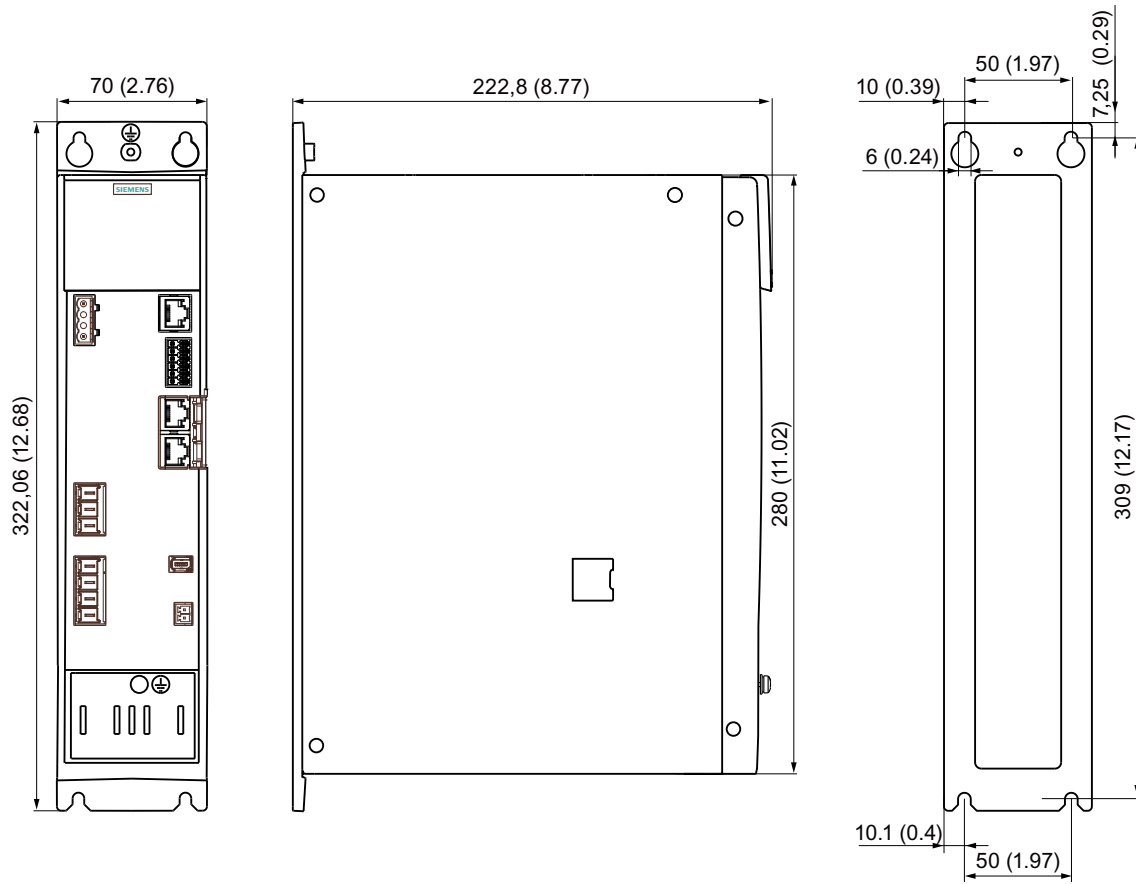

Figure 11-9 Dimension drawing SINAMICS S210 FSC, dimensions in mm (inches)

FSA with 3 AC line connection



FSB with 3 AC line connection



FSB with 3 AC line connection

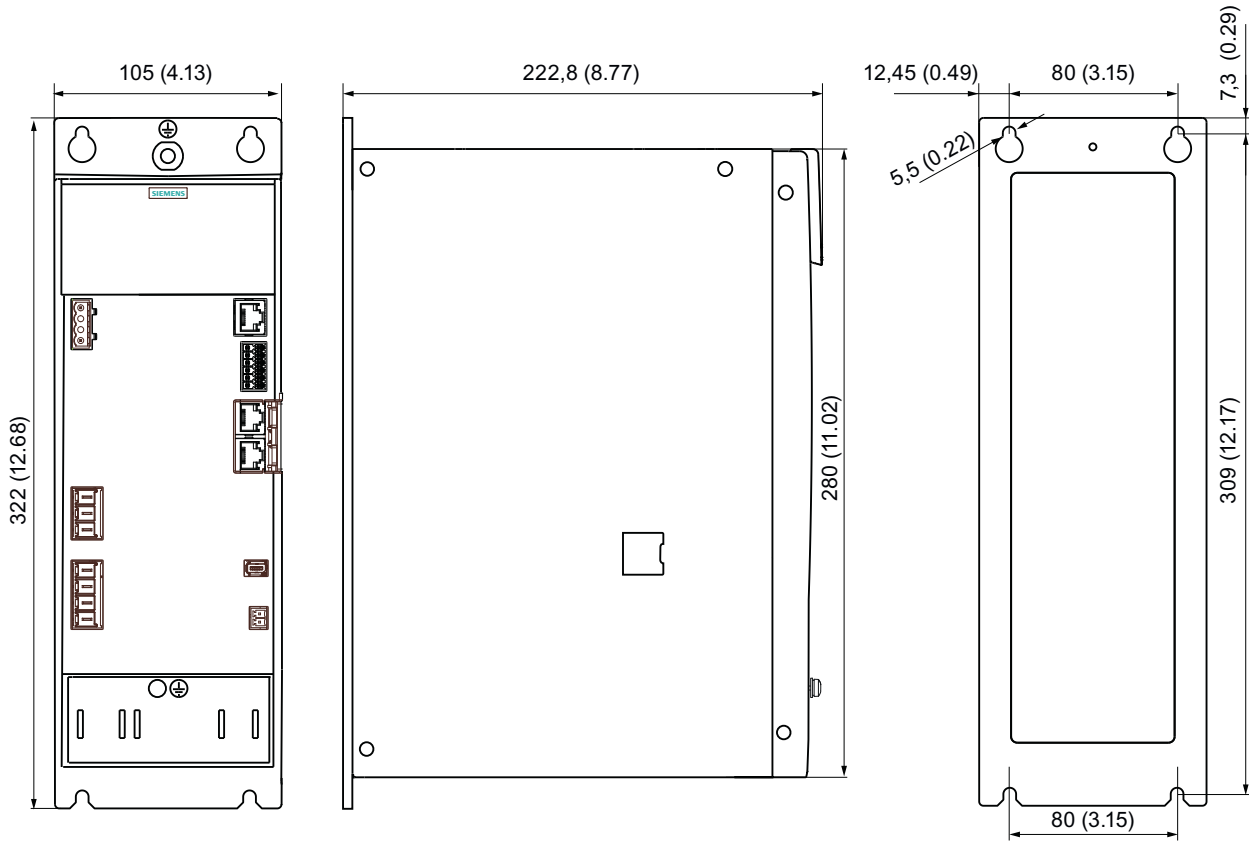

Decommissioning and disposal

WARNING

Risk of injury through falling motors or machine components

Motors and machine components can fall when being dismantled from the machine. They can cause serious injury or property damage.

- Secure the machine components being dismantled to prevent them falling.

Removing the device from the machine

Procedure

1. Check that all parts of the device are in a no voltage condition.
2. Let the device cool down enough so that you are not burnt.
3. Disconnect all electrical connections.
4. Remove the fixing elements.
5. Transport the device to a suitable location for disposal.

You have removed the device.



Recycling and disposal



For environmentally-friendly recycling and disposal of your old device, please contact a company certified for the disposal of waste electrical and electronic equipment, and dispose of the old device as prescribed in the respective country of use.

Ordering data

13.1 Ordering data of the motor

The article number comprises a combination of digits and letters. It is divided into three hyphenated blocks.

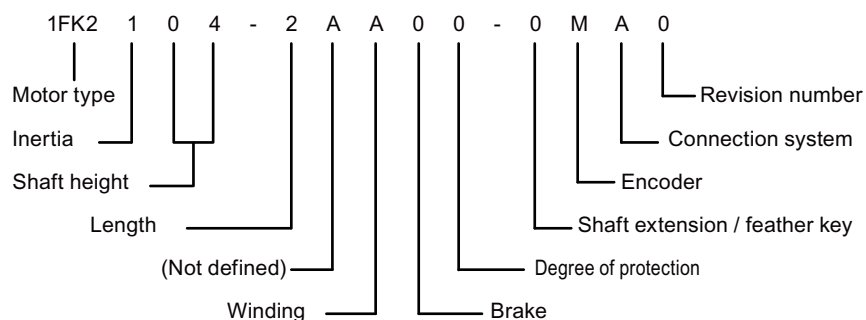

Note that not every theoretical combination is possible in practice.

Permissible combinations can be obtained in Chapter "Motor-converter combinations (Page 44)" or in the catalog "D 32 SINAMICS S210 und SIMOTICS S-1FK2".

Ordering data

13.1 Ordering data of the motor

Description	Position of the article number																			
	1	2	3	4	5	6	7	-	8	9	10	11	12	-	13	14	15	16		
SIMOTICS M-1FK7 synchronous servomotors	1	F	K	2																
Version	Low Inertia				1															
	Medium Inertia				2															
	High Inertia				3															
Frame size / shaft height	SH 20				0	2														
	SH 30				0	3														
	SH 40				0	4														
	SH 48 (Medium Inertia)				0	5														
	SH 52 (Low Inertia)																			
	SH 63				0	6														
	SH 80				0	8														
	SH 100				1	0														
Overall length	see data tables																			
reserved										A										
Winding, rated speed	max. 1 AC 240 V																			
	3000 rpm @ 230 V																			G
	max. 3 AC 480 V																			
	1500 rpm @ 400 V																			B
	2000 rpm @ 400 V				1000 rpm @ 230 V															C
	3000 rpm @ 400 V				1500 rpm @ 230 V															F
	6000 rpm @ 400 V				3000 rpm @ 230 V															K
Holding brake	Without											0								
	With											1								
Protection class	IP64											0								
	IP65 with radial shaft seal ring, without spring											1								
Shaft geometry	Plain shaft														0					
	Shaft with feather key														1					
	Plain shaft, alternative shaft geometry (11 mm x 23 mm), only SH 30				0	3							0	2						
Type of connection	Absolute encoder, singleturn, 22 bit (encoder AS22DQC)																	S		
	Absolute encoder multiturn 22 bit + 12 bit (encoder AM22DQC)																	M		
Revision number	Start																	A		
Revision number	0																			

13.2 Ordering data of the converter

An overview of the available converters is provided below.

Converters with 1 AC line connection

Article number	Frame size	Rated power
6SL3210-5HB10-1UF0	FSA	100 W
6SL3210-5HB10-2UF0	FSA	200 W
6SL3210-5HB10-4UF0	FSB	400 W
6SL3210-5HB10-8UF0	FSC	750 W

Converters with 3 AC line connection

Article number	Frame size	Rated power
6SL3210-5HE10-4UF0	FSA	0.4 kW
6SL3210-5HE10-8UF0	FSA	0.75 kW
6SL3210-5HE11-0UF0	FSA	1 kW
6SL3210-5HE11-5UF0 ¹⁾	FSB	1.5 kW
6SL3210-5HE12-0UF0 ¹⁾	FSB	2 kW
6SL3210-5HE13-5UF0 ²⁾	FSC	3.5 kW
6SL3210-5HE15-0UF0 ²⁾	FSC	5 kW
6SL3210-5HE17-0UF0 ²⁾	FSC	7 kW

¹⁾ Available from about May 2019

²⁾ Available from about September 2019

You can find additional details regarding motors and converters here:





Technical specifications (Page 279).

13.3 Connection cables between the motor and the converter

OCC MOTION-CONNECT cables can only be ordered as prefabricated cables.

OCC MOTION-CONNECT cable with SPEED-CONNECT connector

Designation and use	Cable type	For connection to motor	Connector size	Article number ¹⁾		
Motor connection cable OCC MC 500 for predominantly fixed installation		1FK2□02	M12	6FX5002-8QN04-□□□□		
		1FK2□03	M17	6FX5002-8QN08-□□□□		
		1FK2□04				
		1FK2□05				
		1FK2□06	M23	1.5 mm ² : 6FX5002-8QN11-□□□□		
		1FK2□08		2.5 mm ² : 6FX5002-8QN21-□□□□		
		1FK2□10				
		Motor connection cable OCC MC 800PLUS for use in cable carrier		1FK2□02	M12	6FX8002-8QN04-□□□□
				1FK2□03	M17	6FX8002-8QN08-□□□□
1FK2□04						
1FK2□05						
1FK2□06	M23			1.5 mm ² : 6FX8002-8QN11-□□□□		
1FK2□08				2.5 mm ² : 6FX8002-8QN21-□□□□		
1FK2□10						
Extension cable OCC MC 500 for predominantly fixed installation				1FK2□02	M12	6FX5002-8QE04-□□□□
				1FK2□03	M17	6FX5002-8QE08-□□□□
		1FK2□04				
		1FK2□05				
		1FK2□06	M23	1.5 mm ² : 6FX5002-8QE11-□□□□		
		1FK2□08		2.5 mm ² : 6FX5002-8QE21-□□□□		
		1FK2□10				
		Extension cable OCC MC 800PLUS for use in cable carriers		1FK2□02	M12	6FX8002-8QE04-□□□□
				1FK2□03	M17	6FX8002-8QE08-□□□□
1FK2□04						
1FK2□05						
1FK2□06	M23			1.5 mm ² : 6FX8002-8QE11-□□□□		
1FK2□08				2.5 mm ² : 6FX8002-8QE21-□□□□		
1FK2□10						

¹⁾ The last 4 positions (□□□□) define the cable length corresponding to the length code

Determining the article number of a prefabricated OCC MOTION-CONNECT cable

Figure 13-1 Lengths of an OCC MOTION-CONNECT cable

Procedure

1. Determine the required cable length I^{**} . Consider having cable in reserve for strain-free routing.
2. Determine the length code for the required length I^{**} corresponding to the following overview. The stretched lengths (*) are added automatically for the prefabricated cables.

13.3 Connection cables between the motor and the converter

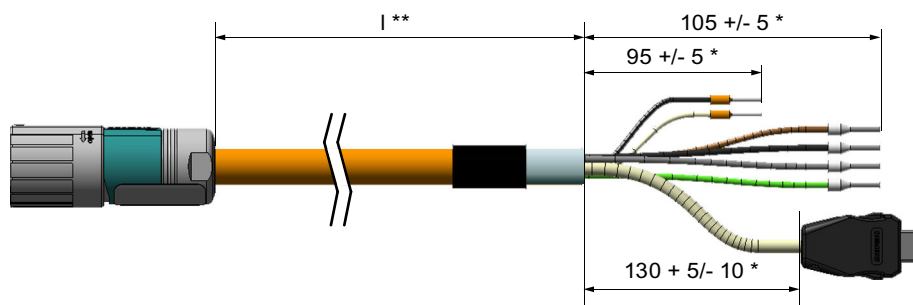
3. Also select the cable type, the desired cable version, and the required connectors for the article number

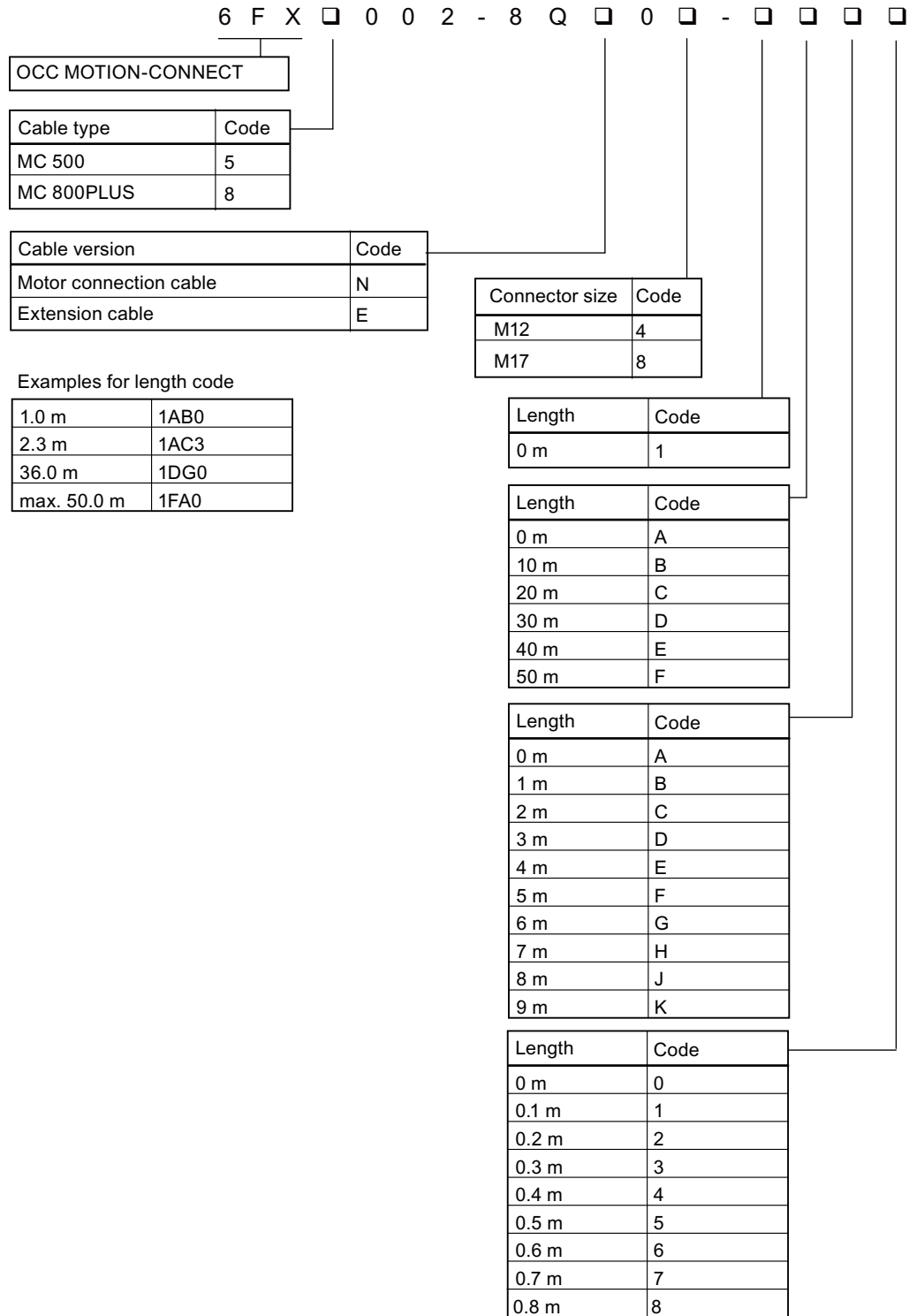

Figure 13-2 Structure of the article number with length code for an OCC MOTION-CONNECT cable

4. Order the required cable with the article number that has been determined.

13.4 Accessories

13.4.1 Memory cards

Memory card for data backup and series commissioning

Use the following memory cards to backup data and for series commissioning:

Card type	Article number
Empty SD card	6SL3054-4AG00-2AA0
SD card with firmware V5.1	6SL3054-4FB00-2BA0
SD card with firmware V5.1 SP1	6SL3054-4FB10-2BA0
SD card with firmware V5.1 SP1 and license for Extended Safety Functions	6SL3054-4FB10-2BA0-Z F01
SD card with firmware V5.2	6SL3054-4FC00-2BA0
SD card with firmware V5.2 and license for Extended Safety Functions	6SL3054-4FC00-2BA0-Z F01
as of firmware version 5.1 SP1: License for Extended Safety Functions "Certificate of License" without SD card, to subsequently license an existing SD card	6SL3074-0AA10-0AA0

If you are using functions that require a license, then one of the memory cards listed above is absolutely necessary for converter operation.

Note

Permissible memory cards

The integrated card reader supports SD cards up to a memory capacity of 2 GB.

SDHC or SDXC cards are not supported.

Memory cards for converters with 3 AC line connection

For converters with 3 AC line connection, you need an empty SD card or an SD card with version 5.2 or higher.

13.4.2 Connectors and cables for line and DC link cabling

The following packages are available for the connectors

- 6SL3260-2DC10-0AA0: Connector package for line cabling
- 6SL3260-2DC00-0AA0: Connector package for line cabling and DC link coupling

Contents	6SL3260-2DC10-0AA0:	6SL3260-2DC00-0AA0:
• Connector for the line cabling	1	1
• Connector for the DC link coupling	-	1
• End caps	1	2
• Description/data sheet	1	1

The connectors are designed so that they cannot be accidentally interchanged.

X1: Connector for the line cabling

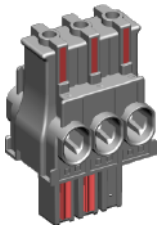
	Pin	Pin assignment	Explanation
	L1	Phase L1 line system	The terminals are Torx screw terminals. Permissible conductor cross-sections • 16 mm ² • AWG: 6 Tightening torque: 3 Nm
	L2	Phase L2 line system	
	L3	Phase L3 line system	

X3: Connector for the DC link coupling

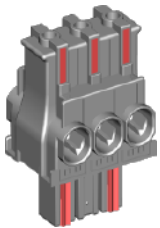
	Pin	Pin assignment	Explanation
	DCP	DC link, positive	The terminals are Torx screw terminals. Permissible conductor cross-sections • 16 mm ² • AWG: 6 Tightening torque: 3 Nm
	--	not assigned	
	DCN	DC link, negative	

End cap for line cabling and DC link coupling



13.4.3 PROFINET patch cable

PROFINET patch cable

Use the following patch cable to network converters located adjacent one another via PROFINET:

Cable type	Length	Article number
Industrial Ethernet TP cord, CAT 6A, TP cable 4 x 2 conductors, prefabricated with 2 RJ45 connectors	0.3 m	6XV1870-3QE30
	0.5 m	6XV1870-3QE50

13.4.4 External line filter

The following external line filter is available for the converter:

Article number	Rated current	Type of connection	Conductor cross-section	Degree of protection	Dimensions (W x H x D)
6SL3203-0BB21-8VA0	18 A	200 V ... 240 V 1 AC	10 mm ²	IP20	59 x 155 x 53

Note

Approval

This network filter currently has no UL approval.

13.4.5 Cabinet bushing via mounting flange

Mounting accessories for connection system

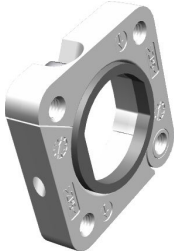
Accessories	Diagram	For connector size	For motor	Article number
Mounting flange as cabinet bushing (with installation instructions) Packing unit: 1 item		M12	1FK2□02 1FK2□03	6FX2003-7JX00
		M17	1FK2□04	6FX2003-7HX00

The mounting flange is installed on the external wall of the control cabinet. It ensures the degree of protection of the control cabinet.

- Install the mounting flange as specified in the enclosed installation instructions.

13.4.6 Degree of protection kit IP65 for the motor

Shaft sealing ring - IP65 degree of protection kit for the motor

The shaft sealing ring can be used as spare part or for retrofitting.

Note

You can order a motor with shaft sealing ring (degree of protection IP65) directly.

Additional information about ordering degree of protection IP65 can be found in Chapter:

 "Ordering data of the motor (Page 333)"

The motor satisfies degree of protection IP65 when the shaft sealing ring is installed.

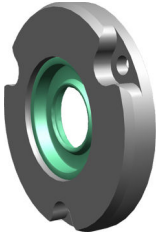
Motor article number	Figure of the shaft sealing ring	Article number of the degree of protection kit
1FK2□02		1FK2902-0GC00
1FK2□03		1FK2903-0GC00
1FK2□04		1FK2904-0GC00

13.5 Spare parts

Spare parts for the converter

The following components are available as spare parts for the converter:

- Connector set for converters with 1 AC line connection 6SL3260-2DB00-0AA0
- Connector set for converters with 3 AC line connection 6SL3260-2DB10-0AA0
- Siemens IX connector for the encoder connection 6FX2003-0DE01
for converters with 1 AC / 3 AC line connection
- Fan for converters with 3 AC line connection, FSA 6SL3260-0AA00-0AA0
- Fan for converters with 3 AC line connection, FSB 6SL3260-0AB00-0AA0
- Fan for converters with 3 AC line connection, FSC 6SL3260-0AC00-0AA0

13.5.1 Connector set for converters with 1 AC line connection - 6SL3260-2DB00-0AA0

Under this article number, you will receive a spare parts package for the frame sizes FSA, FSB and FSC with the following content:

- Connectors
 - X1: Connector for the line connection and the external braking resistor (jumper for internal braking resistor is included)
 - X2: Connector for the motor connection
 - X107: Connector for the motor holding brake
 - X124: Connector for the external 24 V DC power supply
 - X130: Connector for the digital inputs
- Shield plate for FSA, FSB and FSC

X1: Connector for the line connection and the external braking resistor

	Pin	Pin assignment	Explanation
	L1	Phase L1 line system	
	N	Neutral conductor	
	DCP	Braking resistor, external Braking resistor, internal	If you are using the internal braking resistor, DCP and R2 must be jumpered.
	R2	Internal braking resistor	If you are using the external braking resistor, remove the jumper between DCP and R2. Connect the external braking resistor via the DCP and R1 terminals.
	R1	External braking resistor	
Weidmüller: BLF 5.08HC/05/180F SN BK BX, article number 1012670000 As daisy chain: BLDF 5.08/05/180F SN BK BX, article number 1000970000			

The terminals are spring-loaded terminals.

Permissible conductor cross-sections for single-conductor connection or for connecting flexible cables with end sleeves:

- 0.2 mm² ... 2.5 mm²
- AWG: 26 ... 12

X2: Connector for the motor connection

	Pin	Pin assignment	Color coding for Siemens OCC cables
	U	Motor phase U	Brown
	V	Motor phase V	Black
	W	Motor phase W	Gray
	PE	Protective ground	Green-yellow
Weidmüller: BLF 5.08HC/04/180F SN BK BX, article number 1012660000			

The terminals are spring-loaded terminals.

Permissible conductor cross-sections for single-conductor connection or for connecting flexible cables with end sleeves:

- 0.2 mm² ... 2.5 mm²
- AWG: 26 ... 12

X107: Connector for the motor holding brake

	Pin	Pin assignment	Explanation
	BR-	B-	Voltage for motor holding brake, 0 V (white)
	BR+	B+	Voltage for motor holding brake, 24 V (black)
Phoenix 1745894 FMC 1.5 / 2-ST-3.81, article number 1745894			

The terminals are spring-loaded terminals.

Permissible conductor cross-sections:

- For single-conductor cables or for flexible cables with end sleeves without plastic protection:
 - 0.25 mm² ... 1.5 mm²
 - AWG: 24 ... 16
- For flexible cables with end sleeves with plastic protection:
 - 0.25 mm² ... 0.75 mm²
 - AWG: 24 ... 19

Also connect the conductors for the motor holding brake to the connector at X107, even when you are using a motor without holding brake.

X124: Connector for the external 24 V DC control voltage

	Pin	Pin assignment	Explanation
	M	0 V	Power supply for the converter electronics
	M	0 V	
	L+	24 V	
	L+	24 V	
Dinkle article number 2ESS-6621-04P			

The terminals are spring-loaded terminals.

Permissible conductor cross-sections for single-conductor connection or for connecting flexible cables with or without end sleeves:

- 0.2 mm² ... 2.5 mm²
- AWG: 26 ... 12

X130: Connector for the digital inputs

	Pin	Pin assignment	Pin assignment	Pin
	L+	24 V supply	Failsafe Digital Input	DI 2+
	DI 0	High-speed DI, measuring input		DI 2-
	M	Ground		DI 3+
	L+	24 V supply		DI 3-
	DI 1	High-speed DI, measuring input	24 V supply	L+
	M	Ground	Digital input	DI 4
Phoenix 1790140 DFMC 1.5 / 6-ST-3.5, article number 1790140				

The terminals are spring-loaded terminals.

The three "L+" terminals are designed as power supply for external sensors. They are short-circuit proof and provide a max. of 50 mA per sensor. A sensor short-circuit interrupts the power supply for all three sensors.

Permissible conductor cross-sections:

- For single-conductor connection:
 - 0.2 mm² ... 1.5 mm²
 - AWG: 24 ... 16
- For flexible cables with end sleeves:
 - 0.25 mm² ... 1.5 mm²
 - AWG: 24 ... 16
- For flexible cables with end sleeves with plastic protection:
 - 0.25 mm² ... 0.75 mm²
 - AWG: 24 ... 19

13.5.2 Connector set for converters with 3 AC line connection - 6SL3260-2DB10-0AA0

Under this article number, you will receive a spare parts package for the frame sizes FSA, FSB and FSC with the following content:

- Connectors
 - X1: Standard connector for the line connection
 - X2: Connector for the motor connection
 - X4: Connector for the external braking resistor
Cable jumper - is required if you do not connect a braking resistor
 - X107: Connector for the motor holding brake
 - X124: Connector for the external 24 V DC power supply
 - X130: Connector for the digital inputs
- Shield plate with two fixing screws M4 x 10 for FSA

X1: Connector for the line connection

Standard connector

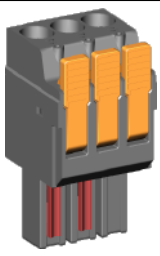
	Pin	Pin assignment	Explanation
	L1	Phase L1 line system	
	L2	Phase L2 line system	
	L3	Phase L3 line system	

The terminals are spring-loaded terminals.

Permissible conductor cross-sections for single-conductor connection or for connecting flexible cables with or without end sleeves:

- 0.75 mm² ... 6 mm²
- AWG: 18 ... 10

X2: Connector for the motor connection

	Pin	Pin assignment	Color coding for Siemens OCC cables
	U	Motor phase U	Brown
	V	Motor phase V	Black
	W	Motor phase W	Gray
	PE	Protective ground	Green-yellow

The terminals are spring-loaded terminals.

Permissible conductor cross-sections for single-conductor connection or for connecting flexible cables with or without end sleeves:

- 0.75 mm² ... 6 mm²
- AWG: 18 ... 10

X4: Connector for the external braking resistor

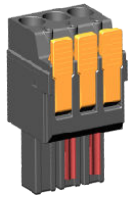
	Pin	Pin assignment	Explanation
	DCP	Braking resistor, external braking resistor, internal	If you are using the internal braking resistor, DCP and R2 must be jumpered. If you are using the external braking resistor, remove the jumper between DCP and R2.
	R1	Internal braking resistor	
	R2	External braking resistor	Connect the external braking resistor via the DCP and R1 terminals.

The terminals are spring-loaded terminals.

Permissible conductor cross-sections for single-conductor connection or for connecting flexible cables with or without end sleeves:

- 0.75 mm² ... 6 mm²
- AWG: 18 ... 10

X107: Connector for the motor holding brake

	Pin	Pin assignment	Explanation
	BR-	B-	Voltage for motor holding brake, 0 V (white)
	BR+	B+	Voltage for motor holding brake, 24 V (black)
Phoenix 1745894 FMC 1.5 / 2-ST-3.81, article number 1745894			

The terminals are spring-loaded terminals.

Permissible conductor cross-sections:

- For single-conductor cables or for flexible cables with end sleeves without plastic protection:
 - 0.25 mm² ... 1.5 mm²
 - AWG: 24 ... 16
- For flexible cables with end sleeves with plastic protection:
 - 0.25 mm² ... 0.75 mm²
 - AWG: 24 ... 19

Also connect the conductors for the motor holding brake to the connector at X107, even when you are using a motor without holding brake.

X124: Connector for the external 24 V DC control voltage

	Pin	Pin assignment	Explanation
	M	0 V	Power supply for the converter electronics
	M	0 V	
	L+	24 V	
	L+	24 V	

The terminals are spring-loaded terminals.

Permissible conductor cross-sections for single-conductor connection or for connecting flexible cables with or without end sleeves:

- 0.2 mm² ... 2.5 mm²
- AWG: 26 ... 12

X130: Connector for the digital inputs

	Pin	Pin assignment	Pin assignment	Pin
	L+	24 V supply	Failsafe Digital Input	DI 2+
	DI 0	High-speed DI, measuring input		DI 2-
	M	Ground		DI 3+
	L+	24 V supply		DI 3-
	DI 1	High-speed DI, measuring input	24 V supply	L+
	M	Ground	Digital input	DI 4

The terminals are spring-loaded terminals.

The three "L+" terminals are designed as power supply for external sensors. They are short-circuit proof and provide a max. of 50 mA per sensor. A sensor short-circuit interrupts the power supply for all three sensors.

Permissible conductor cross-sections:

- For single-conductor connection:
 - 0.2 mm² ... 1.5 mm²
 - AWG: 24 ... 16
- For flexible cables with end sleeves:
 - 0.25 mm² ... 1.5 mm²
 - AWG: 24 ... 16
- For flexible cables with end sleeves with plastic protection:
 - 0.25 mm² ... 0.75 mm²
 - AWG: 24 ... 19

Parameters

14.1 Parameter overview

Structure of the parameter descriptions

Some variables and settings of the converter are displayed via parameters. There are adjustable parameters and display parameters.

Different representations of adjustable parameters and display parameters - as well as the components of the parameter description - are subsequently explained.

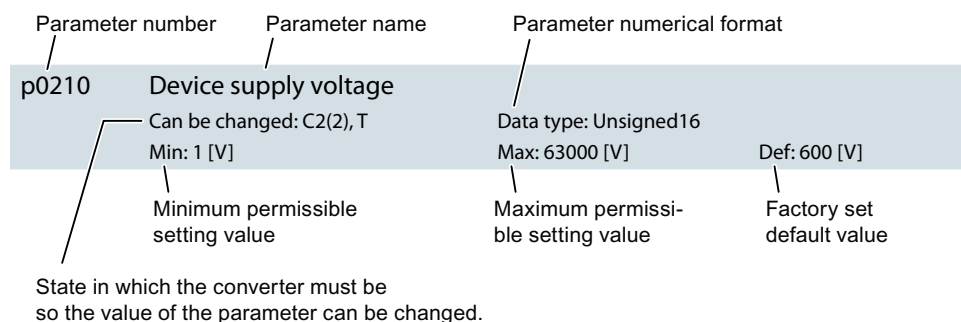

Figure 14-1 Adjustable parameters

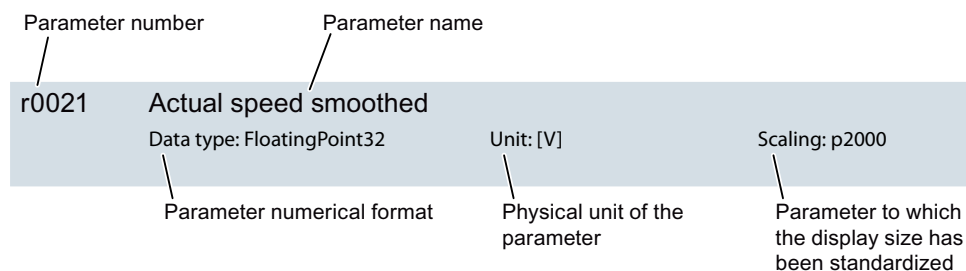

Figure 14-2 Display parameters

For parameters that apply to both rotary as well as linear motion, the unit is displayed for both motion types.

Parameter number

The parameter number is made up of a "p" or "r", followed by the parameter number and optionally the index or bit array.

Examples of how parameters are shown in the parameter list:

- **p...** Adjustable parameters (read and write)
- **r...** Display parameters (read-only)
- **p0977** Adjustable parameter 977

- **p0489[0...2]** Adjustable parameter 489 indices 0 to 2
- **r0944** Display parameter 944
- **p9515.0 ... 16** Adjustable parameter 9515 with bit arrays from bit 0 to bit 16

Further examples of the notation in the documentation:

- **p9531[1]** Adjustable parameter 9531 index 1
- **p0940.1** Adjustable parameter 940, bit 1

Can be changed

The "-" sign indicates that the parameter can be changed in any object state and that the change will be effective immediately.

The information "C1(x), C2(x), T, U" ((x): optional) means that the parameter can only be changed in this converter state and that the change will not take effect until the state has been exited. One or more states are possible.

The following states are possible:

- **C1(x) Device commissioning C1: Commissioning 1**
The device is being commissioned (p0009 > 0). The pulses cannot be enabled.
The parameter can only be changed in the following device commissioning settings (p0009 > 0):

- C1: Can be changed for all settings p0009 > 0.
- C1(x): Can only be changed for settings p0009 = x.

A changed parameter value does not take effect until the device commissioning is exited with p0009 = 0.

- **C2(x) Drive object commissioning C2: Commissioning 2**
The drive is commissioned (p0009 = 0 and p0010 > 0). The pulses cannot be enabled.
The parameter can only be changed in the following drive commissioning settings (p0010 > 0):

- C2: Can be changed for all settings p0010 > 0.
- C2(x): Can only be changed for settings p0010 = x.

A changed parameter value does not take effect until the drive commissioning mode is exited with p0010 = 0.

- **U Operation U: Run**
The pulses have been enabled.
- **T ready for operation T: Ready to run**
The pulses have not been enabled and the state "C1(x)" or "C2(x)" is not active.

Data type of the parameters

Every parameter corresponds to one of the following data types. The relevant data type is indicated in the parameter header.

- Integer8 I8 8-bit integer
- Integer16 I16 16-bit integer
- Integer32 I32 32-bit integer
- Unsigned8 U8 8-bit without sign
- Unsigned16 U16 16-bit without sign
- Unsigned32 U32 32-bit without sign
- FloatingPoint32 Float 32-bit floating-point number

Scaling

Specification of the reference variable with which a signal value is automatically converted with a BICO interconnection.

The following reference variables are available:

- p2000 ... p2003: Reference speed, reference voltage, etc.
- PERCENT: 1.0 = 100%
- 4000H: 4000 hex = 100 % (word) or 4000 0000 hex = 100 % (double word)

Parameter values

- **Min**
Minimum value of the parameter [unit]
- **Max**
Maximum value of the parameter [unit]
- **Def**
Value when delivered [unit]
Some parameters are assigned when running up depending on the connected motor.

14.2 List of parameters

Product: SINAMICS S210, Version: 5202300

r0002	Operating display	Unit: -
	Data type: Integer16	
Description:	Operating display for the drive.	
Value:	0: Operation - everything enabled 10: Operation - set "enable setpoint" = "1" 11: Operation - set "Enable speed controller" = "1" 12: Operation - RFG frozen, set "RFG start" = "1" 13: Operation - set "enable RFG" = "1" 14: Operation - speed setpoint not enabled 15: Operation - open brake (p1215) 16: Operation - withdraw braking with OFF1 using "ON/OFF1" = "1" 17: Operation - braking with OFF3 can only be interrupted with OFF2 18: Operation - brake on fault, remove fault, acknowledge 21: Ready for operation - set "Enable operation" = "1" 31: Ready for switching on - set "ON/OFF1" = "0/1" 41: Switching on inhibited - set "ON/OFF1" = "0" 42: Switching on inhibited - set "OC/OFF2" = "1" 43: Switching on inhibited - set "OC/OFF3" = "1" 44: Switching on inhibited - supply STO terminal w/ 24 V (hardware) 45: Switching on inhibited - rectify fault, acknowledge fault, STO 46: Switching on inhibited - exit commissioning mode (p0009, p0010) 70: Initialization 200: Wait for booting/partial booting 250: Device signals a topology error	
Dependency:	See also: r0046	

<p>NOTICE</p> <p>For a display not equal to 0, the drive is either powering up or an enable signal is missing. The control sends these enable signals.</p> <p>For several missing enable signals, the corresponding value with the highest number is displayed.</p> <p>EP: Enable Pulses (pulse enable)</p> <p>RFG: Ramp-function generator</p> <p>COMM: Commissioning</p> <p>MotID: Motor data identification</p> <p>SS2: Safe Stop 2</p> <p>STO: Safe Torque Off</p>

Note

For a display not equal to 0, the drive is either powering up or an enable signal is missing. The control sends these enable signals.

For several missing enable signals, the corresponding value with the highest number is displayed.

EP: Enable Pulses (pulse enable)

RFG: Ramp-function generator

COMM: Commissioning

MotID: Motor data identification

SS2: Safe Stop 2

STO: Safe Torque Off

p0009	Drive commissioning parameter filter 1
	Can be changed: C1, T Data type: Integer16
	Min: 0 Max: 30 Def: 1
Description:	Setting parameter filter 1 to commission the drive.
Value:	0: Ready 1: Device configuration 30: Parameter reset

Note

The drive can only be switched on when in the "Ready" state (p0009 = 0).

p0010	Drive commissioning parameter filter 2
	Can be changed: C2(1), T Data type: Integer16
	Min: 0 Max: 95 Def: 1
Description:	Setting parameter filter 2 for commissioning the drive.
Value:	0: Ready 1: Only Siemens internal 3: Motor commissioning 95: Safety Integrated commissioning

NOTICE

For p0010 = 95:

The safety commissioning Wizard must be carried out in the web server after changing safety parameters. These changes become effective after carry out all of the commissioning steps of the wizards.

Note

For p0010 = 95:

The safety commissioning Wizard must be carried out in the web server after changing safety parameters. These changes become effective after carry out all of the commissioning steps of the wizards.

r0020	Speed setpoint smoothed
	Data type: FloatingPoint32 Unit: [rpm] Scaling: p2000
Description:	Displays the smoothed speed setpoint at the speed controller input.

r0021	Actual speed smoothed
	Data type: FloatingPoint32 Unit: [rpm] Scaling: p2000
Description:	Displays the smoothed actual value of the motor speed.
Dependency:	See also: r0063

14.2 List of parameters

r0026	DC link voltage smoothed Data type: FloatingPoint32 Unit: [V] Scaling: p2001
Description:	Displays the smoothed actual value of the DC link voltage.
Dependency:	See also: r0070
r0027	Absolute actual current smoothed Data type: FloatingPoint32 Unit: [Arms] Scaling: p2002
Description:	Displays the smoothed absolute actual current value.
Dependency:	See also: r0068
r0031	Actual torque smoothed Data type: FloatingPoint32 Unit: [Nm] Scaling: p2003
Description:	Displays the smoothed torque actual value.
Dependency:	See also: r0080
r0032	Active power actual value smoothed Data type: FloatingPoint32 Unit: [kW] Scaling: r2004
Description:	Display for the smoothed actual value of the active power.
Dependency:	See also: r0082
r0034	Motor utilization thermal Data type: FloatingPoint32 Unit: [%] Scaling: PERCENT
Description:	Displays the thermal motor utilization taking into account the ambient temperature set in p0613.
Dependency:	See also: p0613 See also: F07011, A07012
NOTICE After the drive is switched on, the system starts to determine the motor temperature with an assumed model value. This means that the value for the motor utilization is only valid after a stabilization time.	
r0037[0...20]	Drive temperatures Data type: FloatingPoint32 Unit: [°C] Scaling: p2006
Description:	Displays the temperatures of the drive components.
Index:	[0] = Inverter maximum value [1] = Depletion layer maximum value [2] = Reserved [3] = Reserved [4] = Interior of power unit [5] = Inverter 1 [6...12] = Reserved [13] = Depletion layer 1 [14...20] = Reserved
Note The value of -200 indicates that there is no measuring signal. For index [0]: Maximum value of the inverter temperatures (r0037[5...10]). For index [1]: Maximum value of the depletion layer temperatures (r0037[13...18]). The maximum value is the temperature of the hottest inverter or depletion layer. In the case of a fault, the particular shutdown threshold depends on the power unit, and cannot be read out.	

r0039[0...2]	Energy display			
	Data type: FloatingPoint32	Unit: [kWh]		
Description:	Display for the energy values at the drive output terminals.			
Index:	[0] = Energy balance (sum) [1] = Energy drawn [2] = Energy fed back			
	Note			
	For index [0]: Difference between the energy drawn and energy that is fed back.			

r0044	Thermal converter utilization			
	Data type: FloatingPoint32	Unit: [%]	Scaling: PERCENT	
Description:	Displays the thermal converter utilization as a percentage. With this value, various thermal monitoring functions are taken into account.			
Dependency:	See also: r0034			
	Note			
	The thermal motor utilization is displayed in parameter r0034.			

r0046.0...30	Missing enable signal			
	Data type: Unsigned32	Unit: -		
Description:	Displays the missing enable signals. All enable signals are required to operate the drive. The enable signals are set by the control.			
Bit field:	Bit	Signal name	1 signal	0 signal
	00	OFF1 enable missing	Yes	No
	01	OFF2 enable missing	Yes	No
	02	OFF3 enable missing	Yes	No
	03	Operation enable missing	Yes	No
	05	STOP2 enable missing	Yes	No
	08	Safety enable missing	Yes	No
	10	Ramp-function generator enable missing	Yes	No
	11	Ramp-function generator start missing	Yes	No
	12	Setpoint enable missing	Yes	No
	16	OFF1 enable internal missing	Yes	No
	17	OFF2 enable internal missing	Yes	No
	18	OFF3 enable internal missing	Yes	No
	19	Pulse enable internal missing	Yes	No
	21	STOP2 enable internal missing	Yes	No
	26	Drive inactive or not operational	Yes	No
	28	Brake open missing	Yes	No
	30	Speed controller inhibited	Yes	No
Dependency:	See also: r0002			

Note

The value r0046 = 0 indicates that all enable signals for this drive are present.

Bit 00 = 1 (enable signal missing), if:

- the signal source in p0840 is a 0 signal.
- there is a "switching on inhibited".

Bit 01 = 1 (enable signal missing), if:

- the signal source in p0844 or p0845 is a 0 signal.

Bit 02 = 1 (enable signal missing), if:

- the signal source in p0848 or p0849 is a 0 signal.

Bit 03 = 1 (enable signal missing), if:

- the signal source in p0852 is a 0 signal.

Bit 04 = 1 (armature short-circuit active), if:

- the signal source in p1230 has a 1 signal

Bit 05, Bit 06: Being prepared

Bit 08 = 1 (enable signal missing), if:

- safety functions have been enabled and STO is active.
- a safety-relevant message with STO as response is active.

STO enabled via terminals:

- pulse enable via the STO terminals has a 0 signal.

STO enabled via PROFIsafe:

- STO is selected via PROFIsafe.

Bit 09 = 1 (enable signal missing), if:

- the signal source in p0864 is a 0 signal.

Bit 10 = 1 (enable signal missing), if:

- the signal source in p1140 is a 0 signal.

Bit 11 = 1 (enable signal missing) if the speed setpoint is frozen, because:

- the signal source in p1141 is a 0 signal.
- the speed setpoint is entered from jogging and the two signal sources for jogging, bit 0 (p1055) and bit 1 (p1056) have a 1 signal.

Bit 12 = 1 (enable signal missing), if:

- the signal source in p1142 is a 0 signal.

Bit 16 = 1 (enable signal missing), if:

- there is an OFF1 fault response. The system is only enabled if the fault is removed and was acknowledged and the "switching on inhibited" withdrawn with OFF1 = 0.

Bit 17 = 1 (enable signal missing), if:

- commissioning mode is selected (p0009 > 0 or p0010 > 0).
- there is an OFF2 fault response.
- the drive is inactive (p0105 = 0) or is not operational (r7850[DO-Index]=0).

Bit 18 = 1 (enable signal missing), if:

- OFF3 has still not been completed or an OFF3 fault response is present.

Bit 19 = 1 (internal pulse enable missing), if:

- synchronization is running between the basic clock cycle, DRIVE-CLiQ clock cycle and application clock cycle.

Bit 20 = 1 (internal armature short-circuit active), if:

- the drive is not in the state "S4: Operation" or "S5x" (refer to function diagram 2610).
- the internal pulse enable is missing (r0046.19 = 0).

Bit 21 = 1 (enable signal missing), if:

The pulses have been enabled and the speed setpoint has still not been enabled, because:

- the holding brake opening time (p1216) has still not expired.
- the motor has still not been magnetized (induction motor).
- the encoder has not been calibrated (U/f vector and synchronous motor)

Bit 22: Being prepared

Bit 26 = 1 (enable signal missing), if:

- the drive is inactive (p0105 = 0) or is not operational (r7850[DO-Index]=0).
- the drive device is in the "PROFInergy energy-saving mode" (r5600, CU-specific).

Bit 27 = 1 (enable signal missing), if:

- de-magnetizing has still not been completed (only for vector).

Bit 28 = 1 (enable signal missing), if:

- the holding brake is closed or has still not been opened.
- Bit 29: being prepared
- Bit 30 = 1 (speed controller inhibited), if one of the following reasons is present:
 - a 0 signal is available via binector input p0856.
 - the function generator with current input is active.
 - the measuring function "current controller reference frequency characteristic" is active.
 - the pole position identification is active.
 - motor data identification is active (only certain steps).
- Bit 31 = 1 (enable signal missing), if:
 - the speed setpoint from jog 1 or 2 is entered.

r0061[0...1]	Actual speed unsmoothed	Data type: FloatingPoint32	Unit: [rpm]		Scaling: p2000
Description:	Displays the unsmoothed speed actual value sensed by the encoder.				
Index:	[0] = Encoder 1 [1] = Reserved				
r0062	Speed setpoint after the filter	Data type: FloatingPoint32	Unit: [rpm]		Scaling: p2000
Description:	Display for the speed setpoint after the setpoint filters.				
r0063	Actual speed smoothed	Data type: FloatingPoint32	Unit: [rpm]		Scaling: p2000
Description:	Display for the speed actual value.				
Dependency:	See also: r0021, r0061, p1441				
r0068	Absolute current actual value	Data type: FloatingPoint32	Unit: [Arms]		Scaling: p2002
Description:	Displays actual absolute current.				
Dependency:	See also: r0027				
NOTICE The value is updated with a sampling time of 1 ms. The absolute current actual value is available smoothed (r0027) and unsmoothed (r0068).					
Note					
The value is updated with a sampling time of 1 ms. The absolute current actual value is available smoothed (r0027) and unsmoothed (r0068).					
r0070	Actual DC link voltage	Data type: FloatingPoint32	Unit: [V]		Scaling: p2001
Description:	Display for the measured actual value of the DC link voltage.				
Dependency:	See also: r0026				
Note					
The DC link voltage is available smoothed (r0026) and unsmoothed (r0070).					
r0076	Current actual value field-generating	Data type: FloatingPoint32	Unit: [Arms]		Scaling: p2002
Description:	Display for the actual value of the field-generating current Id.				

14.2 List of parameters

r0077	Current setpoint torque-generating	Data type: FloatingPoint32	Unit: [Arms]	Scaling: p2002
Description:	Displays the torque/force-generating current setpoint.			
r0078[0...1]	Current actual value torque-generating	Data type: FloatingPoint32	Unit: [Arms]	Scaling: p2002
Description:	Display for the actual value of the torque-generating current I _q .			
Index:	[0] = Unsmoothed [1] = Smoothed			
r0079[0...1]	Torque setpoint total	Data type: FloatingPoint32	Unit: [Nm]	Scaling: p2003
Description:	Display for the torque setpoint at the output of the speed controller.			
Index:	[0] = Unsmoothed [1] = Smoothed			
r0080	Torque actual value	Data type: FloatingPoint32	Unit: [Nm]	Scaling: p2003
Description:	Display for the actual torque.			
Dependency:	See also: r0031			
	Note The value is available smoothed (r0031) and unsmoothed (r0080).			
r0082[0...3]	Active power actual value	Data type: FloatingPoint32	Unit: [kW]	Scaling: r2004
Description:	Displays the actual active power.			
Index:	[0] = Unsmoothed [1] = Smoothed [2] = Power drawn [3] = Power drawn smoothed			
Dependency:	See also: r0032			
	Note The mechanical active power is available smoothed (r0032 with 100 ms, r0082[1] with p0045) and unsmoothed (r0082[0]). For index [3]: Smoothing time constant = 4 ms			
p0210	Drive unit line supply voltage	Can be changed: T	Data type: Unsigned16	
	Min: 1 [V]		Max: 63000 [V]	Def: 600 [V]
Description:	Sets the drive unit supply voltage. The voltage between two phases should be entered as the device supply voltage. This setting is important for operating with voltages that are less than the voltage range intended for the drive.			

NOTICE

If, in the switched-off state (pulse inhibit), the supply voltage is higher than the entered value, the Vdc controller may be automatically deactivated in some cases to prevent the motor from accelerating the next time the system is switched on. In this case, an appropriate alarm A07401 is output.

U_{rated} = 400 V:

- p0210 = 380 ... 480 V (AC/AC), 510 ... 720 V (DC/AC)

U_{rated} = 500 V:

- p0210 = 500 ... 600 V (AC/AC), 675 ... 900 V (DC/AC)

U_{rated} = 660 ... 690 V:

- p0210 = 660 ... 690 V (AC/AC), 890 ... 1035 V (DC/AC)

U_{rated} = 500 ... 690 V:

- p0210 = 500 ... 690 V (AC/AC), 675 ... 1035 V (DC/AC)

The precharging switch-in threshold for the DC link voltage (Vdc) is calculated from p0210:

Vdc_{pre} = p0210 * 0.82 * 1.35 (AC/AC)

Vdc_{pre} = p0210 * 0.82 (DC/AC)

The undervoltage thresholds for the DC link voltage (Vdc) are calculated from p0210 as a function of the rated power unit voltage:

U_{rated} = 400 V:

- U_{min} = p0210 * 0.78 (AC/AC) > 330 V, p0210 * 0.60 (DC/AC) > 380 V

U_{rated} = 500 V:

- U_{min} = p0210 * 0.76 (AC/AC) > 410 V

U_{rated} = 660 ... 690 V:

- U_{min} = p0210 * 0.82 (AC/AC) > 565 V, p0210 * 0.63 (DC/AC) > 650 V

U_{rated} = 500 ... 690 V:

- U_{min} = p0210 * 0.82 (AC/AC) > 420 V, p0210 * 0.63 (DC/AC) > 480 V

Note

If, in the switched-off state (pulse inhibit), the supply voltage is higher than the entered value, the Vdc controller may be automatically deactivated in some cases to prevent the motor from accelerating the next time the system is switched on. In this case, an appropriate alarm A07401 is output.

U_{rated} = 400 V:

- p0210 = 380 ... 480 V (AC/AC), 510 ... 720 V (DC/AC)

U_{rated} = 500 V:

- p0210 = 500 ... 600 V (AC/AC), 675 ... 900 V (DC/AC)

U_{rated} = 660 ... 690 V:

- p0210 = 660 ... 690 V (AC/AC), 890 ... 1035 V (DC/AC)

U_{rated} = 500 ... 690 V:

- p0210 = 500 ... 690 V (AC/AC), 675 ... 1035 V (DC/AC)

The precharging switch-in threshold for the DC link voltage (Vdc) is calculated from p0210:

Vdc_{pre} = p0210 * 0.82 * 1.35 (AC/AC)

Vdc_{pre} = p0210 * 0.82 (DC/AC)

The undervoltage thresholds for the DC link voltage (Vdc) are calculated from p0210 as a function of the rated power unit voltage:

U_{rated} = 400 V:

- U_{min} = p0210 * 0.78 (AC/AC) > 330 V, p0210 * 0.60 (DC/AC) > 380 V

U_{rated} = 500 V:

- U_{min} = p0210 * 0.76 (AC/AC) > 410 V

U_{rated} = 660 ... 690 V:

- U_{min} = p0210 * 0.82 (AC/AC) > 565 V, p0210 * 0.63 (DC/AC) > 650 V

U_{rated} = 500 ... 690 V:

- U_{min} = p0210 * 0.82 (AC/AC) > 420 V, p0210 * 0.63 (DC/AC) > 480 V

14.2 List of parameters

p0251[0]	Power unit heat sink fan operating hours counter Can be changed: T Data type: Unsigned32 Min: 0 [h] Max: 4294967295 [h] Def: 0 [h]
Description:	Displays the operating hours of the heat sink fan in the power unit. The number of hours operated can only be reset to 0 in this parameter (e.g. after a fan has been replaced).
Dependency:	See also: A30042
	Note For r0193.13 = 0, the following applies: For liquid-cooled chassis power units, the operating hours of the inner fan are displayed in p0251 and not in p0254.
r0302[0]	motor code DRIVE-CLiQ Data type: Unsigned16 Unit: -
Description:	Displays the number of the motor with DRIVE-CLiQ When the drive powers up, the motor code is read out the motor. For r0302 = 0, the motor was not identified.
r0304[0]	Rated motor voltage Data type: FloatingPoint32 Unit: [Vrms]
Description:	Displays the rated motor voltage.
r0305[0]	Rated motor current Data type: FloatingPoint32 Unit: [Arms]
Description:	Displays the rated motor current.
r0307[0]	Rated motor power Data type: FloatingPoint32 Unit: [kW]
Description:	Displays the rated motor power.
r0311[0]	Rated motor speed Data type: FloatingPoint32 Unit: [rpm]
Description:	Displays the rated motor speed.
r0312[0]	Rated motor torque Data type: FloatingPoint32 Unit: [Nm]
Description:	Displays the rated motor torque.
r0316[0]	Motor torque constant Data type: FloatingPoint32 Unit: [Nm/A]
Description:	Sets the torque constant of the synchronous motor. p0316 = 0: The torque constant is calculated from the motor data. p0316 > 0: The selected value is used as torque constant.
	NOTICE When selecting a catalog motor (p0301), this parameter is automatically pre-assigned and is write protected. Information in p0300 should be carefully observed when removing write protection.

Note

When selecting a catalog motor (p0301), this parameter is automatically pre-assigned and is write protected. Information in p0300 should be carefully observed when removing write protection.

r0318[0]	Motor stall current	Data type: FloatingPoint32	Unit: [Arms]
Description:	Displays the rated motor stall current.		
r0319[0]	Motor stall torque	Data type: FloatingPoint32	Unit: [Nm]
Description:	Displays the motor standstill/stall torque.		
r0322[0]	Maximum motor speed	Data type: FloatingPoint32	Unit: [rpm]
Description:	Displays the maximum motor speed.		
Dependency:	See also: p1082		
r0323[0]	Maximum motor current	Data type: FloatingPoint32	Unit: [Arms]
Description:	Displays the maximum permissible motor current.		
r0338[0]	Motor limit current	Data type: FloatingPoint32	Unit: [Arms]
Description:	Sets the motor limit current for synchronous motors (for a 600 V DC link voltage). Using this current, the maximum torque is achieved at the rated speed (voltage limit characteristic).		
Dependency:	If p0338 is changed during quick commissioning (p0010 = 1), then the maximum current p0640 is appropriately pre-assigned. This is not the case when commissioning the motor (p0010 = 3).		
NOTICE			
When selecting a catalog motor (p0301), this parameter is automatically pre-assigned and is write protected. Information in p0300 should be carefully observed when removing write protection.			
r0341[0]	Motor moment of inertia	Data type: FloatingPoint32	Unit: [kgm ²]
Description:	Displays the motor moment of inertia (without load).		
r0479[0...2]	Diagnostics encoder position actual value Gn_XIST1	Data type: Integer32	Unit: -
Description:	Display for the encoder actual position value Gn_XIST1 according to PROFIdrive for diagnostics. The value of r0479 is updated in each DRIVE-CLiQ basic clock cycle and displayed with sign.		
Index:	[0] = Encoder 1 [1] = Reserved [2] = Reserved		
p0488[0...2]	Activate measuring probe 1	Can be changed: T, U	Data type: Integer16
	Min: 0	Max: 210	Def: 210

14.2 List of parameters

Description: Setting to activate/deactivate measuring probe 1.
The inversion of probe 1 is set in p0490.0.

Value: 0: No measuring probe
210: DI 0 (X130 / 1.2)

Index: [0] = Encoder 1
[1] = Reserved
[2] = Reserved

Dependency: See also: p0489, p0490

<p>⚠ CAUTION</p> <p>In order to prevent incorrect measurement values, these parameters may not be written during an active measurement. Refer to the encoder interface for PROFIdrive.</p>

Note
In order to prevent incorrect measurement values, these parameters may not be written during an active measurement.
Refer to the encoder interface for PROFIdrive.

p0489[0...2] Activate measuring probe 2

Can be changed: T, U **Data type:** Integer16
Min: 0 **Max:** 211 **Def:** 211

Description: Setting to activate/deactivate measuring probe 2.
The inversion of probe 2 is set in p0490.1.

Value: 0: No measuring probe
211: DI 1 (X130 / 1.5)

Index: [0] = Encoder 1
[1] = Reserved
[2] = Reserved

Dependency: See also: p0488, p0490

<p>⚠ CAUTION</p> <p>In order to prevent incorrect measurement values, these parameters may not be written during an active measurement. Refer to the encoder interface for PROFIdrive.</p>

Note
In order to prevent incorrect measurement values, these parameters may not be written during an active measurement.
Refer to the encoder interface for PROFIdrive.

p0490 Invert measuring probe

Can be changed: T, U **Data type:** Unsigned32
Min: - **Max:** - **Def:** 0000 bin

Description: Setting to invert digital input 0 or 1 (probe 1, 2).

Bit field:	Bit	Signal name	1 signal	0 signal
	00	DI 0 (X130 / 1.2)	Inverted	Not inverted
	01	DI 1 (X130 / 1.5)	Inverted	Not inverted

Dependency: See also: p0488, p0489

Note

DI: Digital Input

The inversion has no effect on the status display of the digital inputs (r0722).

p0494[0]**Equivalent zero mark input terminal****Can be changed:** T, U**Data type:** Integer16**Min:** 0**Max:** 211**Def:** 0**Description:**

Selects the input terminal for connecting an equivalent zero mark (external encoder zero mark).

Value:

0: No equivalent zero mark (evaluation of the encoder zero mark)

210: DI 0 (X130 / 1.2)

211: DI 1 (X130 / 1.5)

Dependency:

See also: p0490

⚠ CAUTION

In order to prevent incorrect measurement values, these parameters may not be written during an active measurement.

Note

In order to prevent incorrect measurement values, these parameters may not be written during an active measurement.

r0550[0]**Brake status****Data type:** Integer16**Unit:** -**Description:**

Displays the status of the brake.

The value of r0550 is read when the drive powers up.

Value:

0: No data

1: Holding brake

2: High performance holding brake

Dependency:

See also: p1215, r1216, r1217

Note

For p0550 = 1:

The default value for opening time/closing time applies.

For p0550 = 2:

A shorter opening time/closing time is realized if the drive satisfies the preconditions.

p0613[0]**Motor temperature model ambient temperature****Can be changed:** T, U**Data type:** FloatingPoint32**Min:** -40 [°C]**Max:** 100 [°C]**Def:** 20 [°C]**Description:**

Sets the motor ambient temperature.

Based on this value, the motor temperature model calculates the thermal motor utilization (r0034).

Dependency:

See also: r0034

See also: F07011, A07012

r0722.0...4**Digital inputs status****Data type:** Unsigned32**Unit:** -**Description:**

Displays the status of the digital inputs.

Bit field:

Bit	Signal name	1 signal	0 signal
00	DI 0 (X130 / 1.2)	High	Low
01	DI 1 (X130 / 1.5)	High	Low
02	DI 2 (X130 / 2.1-2)	High	Low

14.2 List of parameters

	03	DI 3 (X130 / 2.3-4)	High	Low
	04	DI 4 (X130 / 2.6)	High	Low
Dependency:	See also: p0488, p0489			

Note

DI: Digital Input

For bit 00, 01:

DI 0 and DI 1 are fast digital inputs and can be used to connect a measuring probe (p0488, p0489).

For bits 02, 03:

DI 2 and DI 3 form a failsafe digital input.

For bit 04:

DI 4 is intended to monitor the temperature of the external brake resistor.

r0898.0...14 Control word sequence control

Data type: Unsigned16 **Unit:** -

Description: Display for the control word of the sequence control.
The higher-level control cyclically sends the control word to the drive.

Bit field:	Bit	Signal name	1 signal	0 signal
	00	ON/OFF1	Yes	No
	01	OC / OFF2	Yes	No
	02	OC / OFF3	Yes	No
	03	Enable operation	Yes	No
	04	Enable ramp-function generator	Yes	No
	05	Continue ramp-function generator	Yes	No
	06	Enable speed setpoint	Yes	No
	07	Command open brake	Yes	No
	08	Jog 1	Yes	No
	09	Jog 2	Yes	No
	10	Master control by PLC	Yes	No
	12	Speed controller enable	Yes	No
	14	Command close brake	Yes	No

r0899.0...15 Status word sequence control

Data type: Unsigned16 **Unit:** -

Description: Display for the status word of the sequence control.
The status word is cyclically sent from the drive to the higher-level control.

Bit field:	Bit	Signal name	1 signal	0 signal
	00	Ready for switching on	Yes	No
	01	Ready	Yes	No
	02	Operation enabled	Yes	No
	03	Jog active	Yes	No
	04	No coasting active	OFF2 inactive	OFF2 active
	05	No Quick Stop active	OFF3 inactive	OFF3 active
	06	Switching on inhibited active	Yes	No
	07	Drive ready	Yes	No
	08	Controller enable	Yes	No
	09	Control request	Yes	No
	11	Pulses enabled	Yes	No
	12	Open holding brake	Yes	No
	13	Command close holding brake	Yes	No

14	Pulse enable from the brake control	Yes	No
15	Setpoint enable from the brake control	Yes	No

Note

For bits 00, 01, 02, 04, 05, 06, 09:

For PROFIdrive, these signals are used for status word 1.

For bit 13:

When the "Safe Brake Control" (SBC) is activated and selected, the brake is no longer controlled using this signal.

For bit 14, 15:

These signals are only of significance when the "extended brake control" function module is activated (r0108.14 = 1).

r0922**PROFIdrive PZD telegram selection**

Data type: Unsigned16 **Unit:** -

Description:

Displays the send and receive telegram.

The telegram settings are taken from the higher-level control system.

Value:

3: Standard telegram 3, PZD-5/9

5: Standard telegram 5, PZD-9/9

102: SIEMENS telegram 102, PZD-6/10

105: SIEMENS telegram 105, PZD-10/10

r0924[0...1]**ZSW bit pulses enabled**

Data type: Unsigned16 **Unit:** -

Description:

Displays the position of the "Pulses enabled" status signal in the PROFIdrive telegram.

Index:

[0] = Signal number

[1] = Bit position

p0925**PROFIdrive clock synchronous sign-of-life tolerance**

Can be changed: T, U

Data type: Unsigned16

Min: 0

Max: 65535

Def: 1

Description:

Sets the number of tolerated consecutive sign-of-life errors of the isochronous controller.

The sign-of-life signal is normally received in PZD4 (control word 2) from the controller.

Dependency:

See also: F01912

Note

The sign-of-life monitoring is disabled for p0925 = 65535.

r0930**PROFIdrive operating mode**

Data type: Unsigned16 **Unit:** -

Description:

Displays the operating mode.

3: Closed-loop speed controlled operation without ramp-function generator

r0944**Fault buffer counter**

Data type: Unsigned16 **Unit:** -

Description:

Display for the fault buffer counter

This counter is incremented every time that a fault occurs.

Recommendation:

This is used to check whether an additional fault has occurred while reading out the fault buffer.

Dependency:

See also: r0945, r0947, r0948, r0949, r2109

r0945[0...63]**Fault code**

Data type: Unsigned16 **Unit:** -

Description:

Displays the numbers of faults that have occurred.

14.2 List of parameters

Dependency: See also: r0947, r0948, r0949, r2109, r2130, r2133, r2136

NOTICE
The properties of the fault buffer should be taken from the corresponding product documentation. Drive faults are signaled using parameters r0945, r0947, r0948 and r0949.

Note

The properties of the fault buffer should be taken from the corresponding product documentation. Drive faults are signaled using parameters r0945, r0947, r0948 and r0949.

r0947[0...63]

Fault code

Data type: Unsigned16 **Unit:** -

Description: This parameter is identical to r0945.

r0948[0...63]

Fault received in milliseconds

Data type: Unsigned32 **Unit:** [ms]

Description: Displays the system runtime in milliseconds referred to the day that the fault occurred.

Dependency: See also: r0945, r0947, r0949, r2109, r2130, r2133, r2136

NOTICE
The time comprises r2130 (complete days) and r0948 (milliseconds, incomplete day).

r0949[0...63]

Fault value

Data type: Integer32 **Unit:** -

Description: Displays additional information about the fault that occurred (as integer number).
The fault causes can be found under the fault values of the particular fault number.

Dependency: See also: r0945, r0947, r0948, r2109, r2130, r2133, r2136

Note

The buffer parameters are cyclically updated in the background.
The structure of the fault buffer and the assignment of the indices is shown in r0945.

p0952

Fault cases counter

Can be changed: T, U **Data type:** Unsigned16
Min: 0 **Max:** 65535 **Def:** 0

Description: Number of fault situations since the last reset.

Dependency: The counter is reset with p0952 = 0.
See also: r0945, r0947, r0948, r0949, r2109, r2130, r2133, r2136

r0964[0...6]

Device identification

Data type: Unsigned16 **Unit:** -

Description: Displays the device identification.

The drive internally comprises components, device and drive object. Both components require their own identification parameters according to PROFIdrive

Index: [0] = Company (Siemens = 42)
[1] = Device type
[2] = Firmware version
[3] = Firmware date (year)
[4] = Firmware date (day/month)
[5] = Number of drive objects
[6] = Firmware patch/hot fix

Dependency: See also: r0975

Note

Example:

r0964[0] = 42 --> SIEMENS

r0964[1] = 5410 --> SINAMICS S210 PN

r0964[2] = 501 --> first part firmware version V05.01 (second part, refer to index 6)

r0964[3] = 2018 --> year 2018

r0964[4] = 1705 --> 17th of May

r0964[5] = 1 --> 1 drive object

r0964[6] = 100 --> second part firmware version (complete version: V05.01.01.00)

r0965 PROFIdrive profile number profile version

Data type: Unsigned16 **Unit:** -

Description: Displays the PROFIdrive profile number and profile version.

Constant value = 032A hex.

Byte 1: Profile number = 03 hex = PROFIdrive profile

Byte 2: profile version = 2A hex = 42 dec = version 4.2

Note

When the parameter is read via PROFIdrive, the Octet String 2 data type applies.

r0975[0...10] Drive object identification

Data type: Unsigned16 **Unit:** -

Description: Displays the identification of the drive object.

The drive internally comprises components, device and drive object. Both components require their own identification parameters according to PROFIdrive

Index:

[0] = Company (Siemens = 42)

[1] = Drive object type

[2] = Firmware version

[3] = Firmware date (year)

[4] = Firmware date (day/month)

[5] = PROFIdrive drive object type class

[6] = PROFIdrive drive object sub-type Class 1

[7] = Drive object number

[8] = Reserved

[9] = Reserved

[10] = Firmware patch/hot fix

Dependency: See also: r0964

Note

Example:

r0975[0] = 42 --> SIEMENS

r0975[1] = 11 --> SERVO drive object type

r0975[2] = 102 --> first part, firmware version V01.02 (second part, refer to index 10)

r0975[3] = 2003 --> year 2003

r0975[4] = 1401 --> 14th of January

r0975[5] = 1 --> PROFIdrive drive object, type class

r0975[6] = 9 --> PROFIdrive drive object sub-type class 1

r0975[7] = 2 --> drive object number = 2

r0975[8] = 0 (reserved)

r0975[9] = 0 (reserved)

r0975[10] = 600 --> second part, firmware version (complete version: V01.02.06.00)

14.2 List of parameters

p0976	Reset all parameters	Can be changed: C1(30), C2(30)	Data type: Unsigned16	
		Min: 0	Max: 1	Def: 0
Description:	Resets all parameters of the drive system.			
Value:	0: Inactive			
	1: Start reset of all parameters to factory setting			
Dependency:	See also: p0977			

NOTICE

After changing the value, it is not possible to change parameters until the operation has been completed. Reset is realized in the non-volatile memory.

Procedure:

1. Set p0009 = 30 (parameter reset).
 2. Set p0976 = 1 The system is powered up again.
- p0976 is automatically set to 0 and p0009 is automatically set to 1 after this has been carried out.

Note

After changing the value, it is not possible to change parameters until the operation has been completed. Reset is realized in the non-volatile memory.

Procedure:

1. Set p0009 = 30 (parameter reset).
 2. Set p0976 = 1 The system is powered up again.
- p0976 is automatically set to 0 and p0009 is automatically set to 1 after this has been carried out.
-

p0977	Save all parameters	Can be changed: T, U	Data type: Unsigned16	
		Min: 0	Max: 1	Def: 0
Description:	Saves all parameters of the drive system to the non-volatile memory.			
	When saving, only the adjustable parameters intended to be saved are taken into account.			
Value:	0: Inactive			
	1: Save in non-volatile memory - loaded at POWER ON			
Dependency:	See also: p0976			

NOTICE

The drive power supply may only be switched off after data has been saved (i.e. after data save has been started, wait until the parameter again has the value 0). Writing to parameters is inhibited while saving.

r0979[0...30]	PROFIdrive encoder format	Data type: Unsigned32	Unit: -
Description:	Displays the actual position encoder used according to PROFIdrive.		
Index:	[0] = Header		
	[1] = Type encoder 1		
	[2] = Resolution encoder 1		
	[3] = Shift factor G1_XIST1		
	[4] = Shift factor G1_XIST2		
	[5] = Distinguishable revolutions encoder 1		
	[6...30] = Reserved		

Note

Information about the individual indices can be taken from the following literature:
PROFIdrive Profile Drive Technology

p1082[0]	Maximum speed Can be changed: C2(1), T Min: 0.000 [rpm]	Data type: FloatingPoint32 Max: 210000.000 [rpm]	Def: 1500.000 [rpm]
Description:	Sets the maximum motor speed to a value less than or equal to the maximum motor speed (r0322). The set value is valid for both directions of rotation.		
Dependency:	See also: r0322		
p1083[0]	Speed limit positive Can be changed: T, U Scaling: p2000 Min: 0.000 [rpm]	Data type: FloatingPoint32 Max: 210000.000 [rpm]	Def: 210000.000 [rpm]
Description:	Sets the maximum speed for the positive direction. The set value must be less than or equal to the maximum speed (p1082).		
p1086[0]	Speed limit negative Can be changed: T, U Scaling: p2000 Min: -210000.000 [rpm]	Data type: FloatingPoint32 Max: 0.000 [rpm]	Def: -210000.000 [rpm]
Description:	Sets the maximum speed for the negative direction. The set value must be less than or equal to the maximum speed (p1082).		
p1121[0]	OFF1 ramp-down time Can be changed: C2(1), T, U Min: 0.000 [s]	Data type: FloatingPoint32 Max: 999999.000 [s]	Def: 1.000 [s]
Description:	Sets the ramp-down time after an OFF1 command. The value is referred to the maximum speed (p1082). After an OFF1 command, within this time, the speed setpoint is ramped down from the maximum speed (p1082) to standstill.		
Dependency:	See also: p1082		
p1135[0]	OFF3 ramp-down time Can be changed: C2(1), T, U Min: 0.000 [s]	Data type: FloatingPoint32 Max: 600.000 [s]	Def: 0.000 [s]
Description:	Sets the ramp-down time for quick stop. In this time, after an OFF3, the speed setpoint is reduced from the maximum speed (p1082) down to standstill.		
	Note This time can be exceeded if the DC link voltage reaches its maximum value.		
r1196	DSC position setpoint Data type: Integer32	Unit: -	
Description:	Displays the position setpoint of Dynamic Servo Control in fine pulses.		
	Note DSC: Dynamic Servo Control		
p1215	Motor holding brake configuration Can be changed: T Min: 0	Data type: Integer16 Max: 2	Def: 0

14.2 List of parameters

Description:	Sets the configuration for the motor holding brake. Re value 2: This setting allows the motor shaft to be rotated for installation purposes.
Value:	0: No motor holding brake available 1: Motor holding brake acc. to sequence control 2: Motor holding brake always open
Dependency:	See also: r1216, r1217, p1226, p1227, p1228

⚠ CAUTION

For the setting p1215 = 0, if a brake is used, it remains closed. If the motor moves, this will destroy the brake.
Setting p1215 = 2 is not permissible if the brake is used to hold loads.

r1216 Motor holding brake opening time

Data type: FloatingPoint32 **Unit:** [ms]

Description:	Displays the opening time for the motor holding brake. The speed setpoint is kept at 0 for this time. The speed setpoint is then enabled.
Dependency:	See also: p1215, r1217

r1217 Motor holding brake closing time

Data type: FloatingPoint32 **Unit:** [ms]

Description:	Displays the time to close the motor holding brake. If the drive signals that the motor is at a standstill, if the holding brake is activated, after the closing time has expired, the pulses are canceled. This prevents the load from sagging, for example.
Dependency:	See also: p1215, r1216

p1226[0] Threshold for zero speed detection

Can be changed: T, U **Data type:** FloatingPoint32
Min: 0.00 [rpm] **Max:** 210000.00 [rpm] **Def:** 20.00 [rpm]

Description:	Sets the speed threshold for the standstill identification. The following applies when the motor holding brake is activated: The motor is shut down and held by the brake after the closing time for the brake in p1217 has elapsed. The following applies when the motor holding brake is not activated: The motor is shut down and it then coasts down.
Dependency:	See also: p1215, r1216, r1217, p1227

Note

In order that standstill is identified, the speed threshold in p1226 must be somewhat higher than the speed actual value noise level.

p1227 Zero speed detection monitoring time

Can be changed: T, U **Data type:** FloatingPoint32
Min: 0.000 [s] **Max:** 300.000 [s] **Def:** 4.000 [s]

Description:	Sets the monitoring time for the standstill identification. When the speed setpoint falls below the speed threshold p1226 after OFF1 or OFF3, after the monitoring time that has been set expires, the drive signals that the motor at a standstill.
Dependency:	See also: p1215, r1216, r1217, p1226

Note

The monitoring is deactivated with p1227 = maximum value.

p1228	Pulse suppression delay time Can be changed: T, U Min: 0.000 [s] Data type: FloatingPoint32 Max: 299.000 [s] Def: 0.000 [s]
Description:	Sets the delay time for pulse suppression. When the speed actual value falls below the speed threshold p1226 after OFF1 or OFF3, after the delay time that has been set expires, the drive signals that the motor at a standstill.
Dependency:	See also: p1226, p1227
p1416[0]	Speed setpoint filter 1 time constant Can be changed: T, U Min: 0.00 [ms] Data type: FloatingPoint32 Max: 5000.00 [ms] Def: 0.00 [ms]
Description:	Sets the time constant for the speed setpoint filter (PT1).
	Note The speed setpoint filter is activated with a time constant greater than zero.
p1441[0]	Actual speed smoothing time Can be changed: T, U Min: 0.00 [ms] Data type: FloatingPoint32 Max: 50.00 [ms] Def: 0.00 [ms]
Description:	Sets the smoothing time constant (PT1) for the speed actual value.
Dependency:	See also: r0063
p1460[0]	Speed controller P gain Can be changed: T, U Min: 0.0000 [Nms/rad] Data type: FloatingPoint32 Max: 500000000.0000 [Nms/rad] Def: 0.3000 [Nms/rad]
Description:	Sets the P gain of the speed controller. The drive determines the P gain for One Button Tuning and writes the value to p1460. The value can be changed.
Dependency:	See also: p1462
	Note The higher the set P gain, the faster and more unstable the control.
p1462[0]	Speed controller integral time Can be changed: T, U Min: 0.00 [ms] Data type: FloatingPoint32 Max: 100000.00 [ms] Def: 10.00 [ms]
Description:	Sets the integral time for the speed controller The drive determines the integral time for One Button Tuning - and writes the value to p1462.
Dependency:	See also: p1460
	Note The shorter the integral time, the faster and more unstable the control.
p1498[0]	Load moment of inertia Can be changed: T, U Min: - [kgm ²] Data type: FloatingPoint32 Max: - [kgm ²] Def: - [kgm ²]
Description:	Sets the load moment of inertia. The setting is made during commissioning while the One Button Tuning is being performed.

14.2 List of parameters

p1520[0]	Torque limit upper Can be changed: T, U Scaling: p2003 Min: -1000000.00 [Nm] Max: 20000000.00 [Nm] Def: 0.00 [Nm] Data type: FloatingPoint32
Description:	Setting the upper torque limit. This setting is made as part of the basic commissioning.
Dependency:	See also: p1521, p1532, r1538, r1539
p1521[0]	Torque limit lower Can be changed: T, U Scaling: p2003 Min: -20000000.00 [Nm] Max: 1000000.00 [Nm] Def: 0.00 [Nm] Data type: FloatingPoint32
Description:	Sets the lower torque limit This setting is made as part of the basic commissioning.
Dependency:	See also: p1520, p1532, r1538, r1539
p1532[0]	Torque limit offset Can be changed: T, U Scaling: p2003 Min: -100000.00 [Nm] Max: 100000.00 [Nm] Def: 0.00 [Nm] Data type: FloatingPoint32
Description:	Sets the offset for the torque limit. The setting allows electronic weight equalization to be used for vertical axes. Parameters p1520 and p1521 are offset by the set value in the same direction.
Dependency:	See also: p1520, p1521
 DANGER If the offset is set higher/lower than the lower/upper torque limit, then the unloaded drive can accelerate up to the maximum speed.	
r1538	Upper effective torque limit Data type: FloatingPoint32 Unit: [Nm] Scaling: p2003
Description:	Displays the currently effective upper torque limit.
Note The value in p1538 may not exceed the value in p1521.	
r1539	Lower effective torque limit Data type: FloatingPoint32 Unit: [Nm] Scaling: p2003
Description:	Displays the currently active lower torque limit.
Note The value in p1539 may not exceed the value in p1521.	
p1703[0]	Isq current controller precontrol scaling Can be changed: T, U Min: 0.0 [%] Max: 200.0 [%] Def: 0.0 [%] Data type: FloatingPoint32
Description:	Sets the scaling of the dynamic current controller precontrol for the torque-generating current component Isq.
p1821[0]	Direction of rotation Can be changed: C2(3) Data type: Integer16 Min: 0 Max: 1 Def: 0

Description: Setting to change the direction of rotation.
If the parameter is changed, it reverses the direction of rotation of the motor and the encoder actual value without changing the setpoint.

Value: 0: Clockwise
1: Counter-clockwise

Dependency: See also: F07434

NOTICE

After changing parameter p1821, the direction of rotation is not automatically adapted in the safety area. The following parameters can be used to set the direction of rotation for safety monitoring:
- p9516.1 "Position actual value sign change" (only for operation with encoder)

p2000 **Reference speed**
Can be changed: T **Data type:** FloatingPoint32
Min: 6.00 [rpm] **Max:** 210000.00 [rpm] **Def:** 3000.00 [rpm]

Description: Sets the reference quantity for the speed values.
All speeds specified as relative values refer to this reference quantity.
The reference quantity corresponds to 100% or 4000 hex (word) or 4000 0000 hex (double word).

Dependency: See also: p2003

p2003 **Reference torque**
Can be changed: T **Data type:** FloatingPoint32
Min: 0.01 [Nm] **Max:** 20000000.00 [Nm] **Def:** 1.00 [Nm]

Description: Sets the reference quantity for the torque values.
All torques specified as relative value are referred to this reference quantity.
The reference quantity corresponds to 100% or 4000 hex (word) or 4000 0000 hex (double word).

r2050[0...19] **Diagnostics PZD receive word**
Data type: Integer16 **Unit:** - **Scaling:** 4000H

Description: Displays the received process data (setpoints) in the word format.

Index: [0] = PZD 1
[1] = PZD 2
[2] = PZD 3
[3] = PZD 4
[4] = PZD 5
[5] = PZD 6
[6] = PZD 7
[7] = PZD 8
[8] = PZD 9
[9] = PZD 10
[10] = PZD 11
[11] = PZD 12
[12] = PZD 13
[13] = PZD 14
[14] = PZD 15
[15] = PZD 16
[16] = PZD 17
[17] = PZD 18
[18] = PZD 19
[19] = PZD 20

Dependency: See also: r2060

14.2 List of parameters

r2053[0...27]		Diagnostics PZD send word			
	Data type: Unsigned16	Unit: -			
Description:	Displays the send process data (actual values) in the word format.				
Index:	[0] = PZD 1 [1] = PZD 2 [2] = PZD 3 [3] = PZD 4 [4] = PZD 5 [5] = PZD 6 [6] = PZD 7 [7] = PZD 8 [8] = PZD 9 [9] = PZD 10 [10] = PZD 11 [11] = PZD 12 [12] = PZD 13 [13] = PZD 14 [14] = PZD 15 [15] = PZD 16 [16] = PZD 17 [17] = PZD 18 [18] = PZD 19 [19] = PZD 20 [20] = PZD 21 [21] = PZD 22 [22] = PZD 23 [23] = PZD 24 [24] = PZD 25 [25] = PZD 26 [26] = PZD 27 [27] = PZD 28				
Bit field:	Bit	Signal name	1 signal	0 signal	
	00	Bit 0	ON	OFF	
	01	Bit 1	ON	OFF	
	02	Bit 2	ON	OFF	
	03	Bit 3	ON	OFF	
	04	Bit 4	ON	OFF	
	05	Bit 5	ON	OFF	
	06	Bit 6	ON	OFF	
	07	Bit 7	ON	OFF	
	08	Bit 8	ON	OFF	
	09	Bit 9	ON	OFF	
	10	Bit 10	ON	OFF	
	11	Bit 11	ON	OFF	
	12	Bit 12	ON	OFF	
	13	Bit 13	ON	OFF	
	14	Bit 14	ON	OFF	
	15	Bit 15	ON	OFF	

r2060[0...18]	Diagnostics PZD receive double word	
	Data type: Integer32	Unit: -
		Scaling: 4000H
Description:	Displays the received process data (setpoints) in the double word format.	
Index:	[0] = PZD 1 + 2 [1] = PZD 2 + 3 [2] = PZD 3 + 4 [3] = PZD 4 + 5 [4] = PZD 5 + 6 [5] = PZD 6 + 7 [6] = PZD 7 + 8 [7] = PZD 8 + 9 [8] = PZD 9 + 10 [9] = PZD 10 + 11 [10] = PZD 11 + 12 [11] = PZD 12 + 13 [12] = PZD 13 + 14 [13] = PZD 14 + 15 [14] = PZD 15 + 16 [15] = PZD 16 + 17 [16] = PZD 17 + 18 [17] = PZD 18 + 19 [18] = PZD 19 + 20	
Dependency:	See also: r2050	

r2063[0...26]	Diagnostics PZD send double word	
	Data type: Unsigned32	Unit: -
Description:	Displays the send process data (actual values) in the double word format.	

14.2 List of parameters

Index:

- [0] = PZD 1 + 2
- [1] = PZD 2 + 3
- [2] = PZD 3 + 4
- [3] = PZD 4 + 5
- [4] = PZD 5 + 6
- [5] = PZD 6 + 7
- [6] = PZD 7 + 8
- [7] = PZD 8 + 9
- [8] = PZD 9 + 10
- [9] = PZD 10 + 11
- [10] = PZD 11 + 12
- [11] = PZD 12 + 13
- [12] = PZD 13 + 14
- [13] = PZD 14 + 15
- [14] = PZD 15 + 16
- [15] = PZD 16 + 17
- [16] = PZD 17 + 18
- [17] = PZD 18 + 19
- [18] = PZD 19 + 20
- [19] = PZD 20 + 21
- [20] = PZD 21 + 22
- [21] = PZD 22 + 23
- [22] = PZD 23 + 24
- [23] = PZD 24 + 25
- [24] = PZD 25 + 26
- [25] = PZD 26 + 27
- [26] = PZD 27 + 28

Bit field:	Bit	Signal name	1 signal	0 signal
	00	Bit 0	ON	OFF
	01	Bit 1	ON	OFF
	02	Bit 2	ON	OFF
	03	Bit 3	ON	OFF
	04	Bit 4	ON	OFF
	05	Bit 5	ON	OFF
	06	Bit 6	ON	OFF
	07	Bit 7	ON	OFF
	08	Bit 8	ON	OFF
	09	Bit 9	ON	OFF
	10	Bit 10	ON	OFF
	11	Bit 11	ON	OFF
	12	Bit 12	ON	OFF
	13	Bit 13	ON	OFF
	14	Bit 14	ON	OFF
	15	Bit 15	ON	OFF
	16	Bit 16	ON	OFF
	17	Bit 17	ON	OFF
	18	Bit 18	ON	OFF
	19	Bit 19	ON	OFF
	20	Bit 20	ON	OFF
	21	Bit 21	ON	OFF
	22	Bit 22	ON	OFF

23	Bit 23	ON	OFF
24	Bit 24	ON	OFF
25	Bit 25	ON	OFF
26	Bit 26	ON	OFF
27	Bit 27	ON	OFF
28	Bit 28	ON	OFF
29	Bit 29	ON	OFF
30	Bit 30	ON	OFF
31	Bit 31	ON	OFF

r2109[0...63]**Fault removed in milliseconds****Data type:** Unsigned32 **Unit:** [ms]**Description:**

Displays the time in milliseconds referred to the day that the fault was resolved.

Dependency:

See also: r0945, r0947, r0948, r0949, r2130, r2133, r2136

NOTICE

The time comprises r2136 (days) and r2109 (milliseconds).
 The structure of the fault buffer and the assignment of the indices is shown in r0945.

Note

The time comprises r2136 (days) and r2109 (milliseconds).
 The structure of the fault buffer and the assignment of the indices is shown in r0945.

p2111**Alarm counter****Can be changed:** T, U**Data type:** Unsigned16**Min:** 0**Max:** 65535**Def:** 0**Description:**

Number of alarms that have occurred after the last reset.

Dependency:

When setting p2111 = 0, all of the alarms that have been removed from the alarm buffer [0...7] are transferred into the alarm history [8...63] - and alarm buffer [0...7] is deleted.

See also: r2122, r2123, r2124, r2125

Note

The parameter is reset to 0 at POWER ON.

r2121**Counter alarm buffer changes****Data type:** Unsigned16**Unit:** -**Description:**

This counter is incremented every time the alarm buffer changes.

Dependency:

See also: r2122, r2123, r2124, r2125

r2122[0...63]**Alarm number****Data type:** Unsigned16**Unit:** -**Description:**

Displays the number of the last 64 alarms.

Dependency:

See also: r2123, r2124, r2125, r2134, r2145, r2146

14.2 List of parameters

NOTICE

The properties of the alarm buffer should be taken from the corresponding product documentation.
 Alarm buffer structure (general principle):
 r2122[0], r2124[0], r2123[0], r2125[0] --> alarm 1 (the oldest)
 ...
 r2122[7], r2124[7], r2123[7], r2125[7] --> Alarm 8 (the latest)
 When the alarm buffer is full, the alarms that have gone are entered into the alarm history:
 r2122[8], r2124[8], r2123[8], r2125[8] --> Alarm 1 (the latest)
 ...
 r2122[63], r2124[63], r2123[63], r2125[63] --> alarm 56 (the oldest)

Note

The properties of the alarm buffer should be taken from the corresponding product documentation.
 Alarm buffer structure (general principle):
 r2122[0], r2124[0], r2123[0], r2125[0] --> alarm 1 (the oldest)
 ...
 r2122[7], r2124[7], r2123[7], r2125[7] --> Alarm 8 (the latest)
 When the alarm buffer is full, the alarms that have gone are entered into the alarm history:
 r2122[8], r2124[8], r2123[8], r2125[8] --> Alarm 1 (the latest)
 ...
 r2122[63], r2124[63], r2123[63], r2125[63] --> alarm 56 (the oldest)

r2123[0...63]

Alarm received in milliseconds

Data type: Unsigned32 **Unit:** [ms]

Description: Displays the time in milliseconds referred to the day that the alarm occurred.

Dependency: See also: r2122, r2124, r2125, r2134, r2145, r2146

NOTICE

The time comprises r2145 (days) and r2123 (milliseconds).
 The structure of the alarm buffer and the assignment of the indices is shown in r2122.

Note

The time comprises r2145 (days) and r2123 (milliseconds).
 The structure of the alarm buffer and the assignment of the indices is shown in r2122.

r2124[0...63]

Alarm value

Data type: Integer32 **Unit:** -

Description: Displays additional information about the active alarm (as integer number).

Dependency: See also: r2122, r2123, r2125, r2134, r2145, r2146

Note

The buffer parameters are cyclically updated in the background.
 The structure of the alarm buffer and the assignment of the indices are shown in r2122.

r2125[0...63]

Alarm removed in milliseconds

Data type: Unsigned32 **Unit:** [ms]

Description: Displays the time in milliseconds referred to the day that the alarm was resolved.

Dependency: See also: r2122, r2123, r2124, r2134, r2145, r2146

NOTICE
The time comprises r2146 (days) and r2125 (milliseconds). The structure of the alarm buffer and the assignment of the indices is shown in r2122.

Note

The time comprises r2146 (days) and r2125 (milliseconds).
The structure of the alarm buffer and the assignment of the indices is shown in r2122.

r2130[0...63]	Fault received in days
	Data type: Unsigned16 Unit: -
Description:	Displays the time in days referred to the day that the fault occurred.
Dependency:	See also: r0945, r0947, r0948, r0949, r2109, r2133, r2136

NOTICE
The time comprises r2130 (days) and r0948 (milliseconds).

Note

The time comprises r2130 (days) and r0948 (milliseconds).

r2131	Actual fault number
	Data type: Unsigned16 Unit: -
Description:	Displays the number of the active fault that occurred last.

Note

0: No fault present.

r2132	Actual alarm number
	Data type: Unsigned16 Unit: -
Description:	Displays the number of the alarm that last occurred.

Note

0: No alarm present.

r2133[0...63]	Fault value for float values
	Data type: FloatingPoint32 Unit: -
Description:	Displays the additional information about the fault that occurred for float values. Refer to the fault for the interpretation of the fault value.
Dependency:	See also: r0945, r0947, r0948, r0949, r2109, r2130, r2136

Note

The buffer parameters are cyclically updated in the background.

r2134[0...63]	Alarm value for float values
	Data type: FloatingPoint32 Unit: -
Description:	Displays the additional information about the alarm that occurred for float values. Refer to the alarm for an interpretation of the alarm value.
Dependency:	See also: r2122, r2123, r2124, r2125, r2145, r2146

Note

The buffer parameters are cyclically updated in the background.

14.2 List of parameters

r2136[0...63] **Fault removed in days**
Data type: Unsigned16 **Unit:** -

Description: Displays the time in days referred to the day when the fault was rectified.
Dependency: See also: r0945, r0947, r0948, r0949, r2109, r2130, r2133

NOTICE
The time comprises r2136 (days) and r2109 (milliseconds).

Note
The time comprises r2136 (days) and r2109 (milliseconds).

r2145[0...63] **Alarm received in days**
Data type: Unsigned16 **Unit:** -

Description: Displays the time in days referred to the day that the alarm occurred.
Dependency: See also: r2122, r2123, r2124, r2125, r2134, r2146

NOTICE
The time comprises r2145 (days) and r2123 (milliseconds).

Note
The time comprises r2145 (days) and r2123 (milliseconds).

r2146[0...63] **Alarm removed in days**
Data type: Unsigned16 **Unit:** -

Description: Displays the time in days referred to the day when the alarm was cleared.
Dependency: See also: r2122, r2123, r2124, r2125, r2134, r2145

NOTICE
The time comprises r2146 (days) and r2125 (milliseconds).

Note
The time comprises r2146 (days) and r2125 (milliseconds).

p2175[0] **Motor blocked speed threshold**
Can be changed: T, U **Data type:** FloatingPoint32
Min: 0.00 [rpm] **Max:** 210000.00 [rpm] **Def:** 120.00 [rpm]

Description: Sets the speed threshold for the message "Motor locked".
Monitoring is deactivated with p2175 = 0.

Dependency: See also: F07900

Note
If the motor speed is less than the threshold value set in p2175 - and the motor is operated for longer than 200 ms at the torque limit - then the motor is shut down and a fault is output.

p3103 **UTC synchronization process**
Can be changed: T, U **Data type:** Integer16
Min: 4 **Max:** 99 **Def:** 4

Description: Setting the synchronization process.

Value: 4: Network Time Protocol
99: No synchronization

Note

If value = 4:

Synchronization of the time in the drive with the time specified by the higher-level control system.

p3106**NTP time zone**

Can be changed: T, U

Data type: Integer16

Min: 0

Max: 38

Def: 14

Description:

Sets the local time zone for NTP (Network Time Protocol).

Value:

0: UTC-12 (AOE)
1: UTC-11 (NURT)
2: UTC-10 (HAST)
3: UTC-9:30 (MART)
4: UTC-9 (AKST)
5: UTC-8 (PST)
6: UTC-7 (MST)
7: UTC-6 (CST)
8: UTC-5 (EST)
9: UTC-4 (VET)
10: UTC-3:30 (NST)
11: UTC-3 (ART)
12: UTC-2 (GST)
13: UTC-1 (CVT)
14: UTC+0 (GMT)
15: UTC+1 (CET)
16: UTC+2 (EEK)
17: UTC+3 (MISK)
18: UTC+3:30 (IRST)
19: UTC+4 (GST)
20: UTC+4:30 (AFT)
21: UTC+5 (UZT)
22: UTC+5:30 (IST)
23: UTC+5:45 (NPT)
24: UTC+6 (BST)
25: UTC+6:30 (MMT)
26: UTC+7 (WIB)
27: UTC+8 (CST)
28: UTC+8:30 (PYT)
29: UTC+8:45 (ACWST)
30: UTC+9 (JST)
31: UTC+9:30 (ACST)
32: UTC+10 (AEST)
33: UTC+10:30 (ACDT)
34: UTC+11 (AEDT)
35: UTC+12 (ANAT)
36: UTC+13 (NZDT)
37: UTC+13:45 (CHADT)
38: UTC+14 (LINT)

14.2 List of parameters

Dependency: See also: p3103

p5271[0]

One Button Tuning configuration 1

Can be changed: T **Data type:** Unsigned16
Min: - **Max:** - **Def:** 0001 1100 bin

Description: Sets the configuration for One Button Tuning.

Bit field:	Bit	Signal name	1 signal	0 signal
	03	Setting the speed precontrol	Yes	No
	04	Setting the torque precontrol	Yes	No
	07	Setting the voltage precontrol	Yes	No

Dependency: See also: r5274

Note

For bit 03:
Activation of speed feedforward control.
For bit 04:
Activation of speed/torque precontrol in the drive.
For bit 07:
Activation of the voltage precontrol.

r5274

One Button Tuning dynamic response estimated

Data type: FloatingPoint32 **Unit:** [ms]

Description: Displays the estimated dynamic response of the speed control loop as PT1 time constant for One Button Tuning. The lower the time constant, the higher the dynamic performance.

Dependency: See also: p5271

r5276[0]

One Button Tuning Kv factor estimated

Data type: FloatingPoint32 **Unit:** [1000 rpm]

Description: Displays the estimated position controller gain (Kv factor) for One Button Tuning.

Dependency: See also: p5271

Note

The value for the closed-loop position control is required by a higher-level control system.

r5277[0]

One Button Tuning precontrol symmetrizing time estimated

Data type: FloatingPoint32 **Unit:** [ms]

Description: Displays the estimated precontrol symmetrizing time for One Button Tuning. This is required to symmetrize the position controller if the closed-loop position control is in an external control system.

Dependency: See also: p5271

p5291

FFT tuning configuration

Can be changed: T, U **Data type:** Unsigned32
Min: - **Max:** - **Def:** 0000 0000 0000 0000 0000 0000 0011 1001 bin

Description: Sets the configuration for the "FFT tuning" function. This function is used for One Button Tuning (p5300 = 1).

Bit field:	Bit	Signal name	1 signal	0 signal
	00	Noise excitation after pulse enable	Yes	No
	01	Set current setpoint filter (HF)	Yes	No
	02	Set speed controller gain (HF)	Yes	No
	03	Length of FFT window bit 0 (LF, HF)	Yes	No

04	Length of FFT window bit 1 (LF, HF)	Yes	No
05	Windowing the time signals using a Hamming window (LF, HF)	Yes	No
06	Measure current controller	Yes	No
07	Bandwidth bit 0 (LF)	Yes	No
08	Bandwidth bit 1 (LF)	Yes	No
09	Bandwidth bit 2 (LF)	Yes	No
10	Measuring periods bit 0	Yes	No
11	Measuring periods bit 1	Yes	No
12	Inject noise onto speed setpoint	Yes	No
13	Do not reduce Kp for measurement	Yes	No
14	Set the current setpoint filter with loop compensation	Yes	No
16	Torque in front of the current setpoint filter	Yes	No

Dependency:

See also: r5293, p5296

14.2 List of parameters

Note

HF: high frequency

LF: low frequency

For bit 00:

A PRBS signal (pseudo random binary signal) is superimposed on the current setpoint to be able to better identify the mechanical controlled system.

For bit 01:

The identified mechanical resonance points are suppressed using current setpoint filters.

For bit 02:

The maximum speed controller gain is determined from the identified mechanical controlled system.

For bits 03, 04:

The measured value buffer length is set using these bits:

Bit 04 = 0 and bit 03 = 0 -> buffer length = 256

Bit 04 = 0 and bit 03 = 1 -> buffer length = 512

Bit 04 = 1 and bit 03 = 0 -> buffer length = 1024

Bit 04 = 1 and bit 03 = 1 -> buffer length = 2048

For bit 05:

A Hamming window is used to filter the measured time signals.

For bit 06:

The measurement checks the current controller frequency response and this is taken into account in the speed controller loop. For high amplitudes in p5298, it is possible that the measurement is unsuccessful, as the converter reaches its voltage limit.

For bits 07, 08, 09:

The measurement bandwidth is set using these bits:

Bit 09 = 0, bit 08 = 0, bit 07 = 0 -> bandwidth = 50 Hz

Bit 09 = 0, bit 08 = 0, bit 07 = 1 -> bandwidth = 100 Hz

Bit 09 = 0, bit 08 = 1, bit 07 = 0 -> bandwidth = 200 Hz

Bit 09 = 0, bit 08 = 1, bit 07 = 1 -> bandwidth = 400 Hz

Bit 09 = 1, bit 08 = 0, bit 07 = 0 -> bandwidth = 800 Hz

Bit 09 = 1, bit 08 = 0, bit 07 = 1 -> bandwidth = 1600 Hz

For bits 10, 11:

Number of measuring periods.

Bit 11 = 0 and bit 10 = 0 -> number of measurements = 1

Bit 11 = 0 and bit 10 = 1 -> number of measurements = 2

Bit 11 = 1 and bit 10 = 0 -> number of measurements = 4

Bit 11 = 1 and bit 10 = 1 -> number of measurements = 8

For bit 12:

The PRBS signal is switched to the speed setpoint (in front of the filter).

For bit 13:

The input signal for the torque actual value is taken from in front of the current setpoints filters.

For bit 14:

When the bit is set, a current setpoint filter is used to partially compensate the mechanical system.

This is recommended for the following machine attributes:

- the load moment of inertia is significantly higher than the motor moment of inertia (e.g. > 6x).

- the coupling between the machine elements has almost no backlash (no play).

- the stiffness of the mechanical transmission elements does not change significantly in the traversing range.

p5292

Controller optimization dynamic factor

Can be changed: T, U

Data type: FloatingPoint32

Min: 25.0 [%]

Max: 125.0 [%]

Def: 80.0 [%]

Description:

Sets the dynamic factor for optimizing the speed controller when One Button Tuning is activated (p5300 = 1).

Dependency:

The higher the value in p5292, the lower the value in r5274.

See also: p5291

Note

The higher the dynamic factor, the faster and more unstable the control.

r5293	FFT tuning speed controller P gain identified		
	Data type: FloatingPoint32	Unit: [Nms/rad]	
Description:	Displays the determined proportional gain Kp of the speed controller before FFT tuning. This function is used for One Button Tuning (p5300 = 1).		
Dependency:	See also: p5291		
p5296[0...2]	Controller optimization noise amplitude		
	Can be changed: T, U	Data type: FloatingPoint32	
	Min: 1.0 [%]	Max: 300.0 [%]	Def: [0] 10.0 [%] , [1] 30.0 [%] , [2] 5.0 [%]
Description:	The drive determines the noise amplitude for One Button Tuning and writes the value to p5296.		
Dependency:	See also: p5291		
p5300[0]	One Button Tuning selection		
	Can be changed: T	Data type: Integer16	
	Min: -1	Max: 1	Def: 0
Description:	Setting to activate/deactivate the One Button Tuning function. If p5300 = 1: The One Button Tuning function is configured using p5271 and p5301.		
Value:	-1: Reset controller parameters 0: Inactive 1: One Button Tuning		
Dependency:	The motor must have already been commissioned so that One Button Tuning functions perfectly. The One Button Tuning function is configured using p5271 and p5301. The required dynamic performance of the control loop is set in p5292. The traversing path for the test signal is parameterized in p5308. Additional relevant parameters p5309, p5296, p5297, r5274 See also: p5271, r5274, p5292, r5293, p5296, p5301, p5308, p5309		
	Note If p5300 = -1: One Button Tuning is deactivated and p5300 is automatically set = 0. Further, the presetting values for the speed controller are restored. If p5300 = 0: To permanently save the values for the speed controller that have been determined, the parameters must be saved in a non-volatile memory. If p5300 = 1: One Button Tuning is active. The moment of inertia is determined once using a test signal. The controller parameters and current setpoint filters are additionally determined once using a noise signal as excitation source. The steps to be executed can be configured using p5301.		
p5301[0]	One Button Tuning configuration 2		
	Can be changed: T, U	Data type: Unsigned32	
	Min: -	Max: -	Def: 0000 0000 0000 0111 bin
Description:	Setting the functions for One Button Tuning (p5300 = 1). A test signal is required for some functions. Here, parameters p5307 to p5309 must be taken into consideration.		
Bit field:	Bit	Signal name	1 signal 0 signal
	00	Setting the proportional gain Kp	Yes No
	01	Setting current setpoint filter	Yes No
	02	Estimate moment of inertia	Yes No

14.2 List of parameters

	07	Activating synchronized axes	Yes	No
	08	Moment of inertia determination from frequency response	Yes	No
Dependency:	It is only possible to change the configuration if One Button Tuning is not active (p5300 = 0). See also: p5292, r5293, p5296, p5300, p5308, p5309			

Note

For bit 00:
The speed controller gain is determined and set using a noise signal.

For bit 01:
Possibly required current setpoint filters are determined and set using a noise signal.
As a consequence, a higher dynamic performance can be achieved in the speed control loop.

For bit 02:
Using this bit, the moment of inertia is determined using a test signal. If this bit is not set, then the load moment of inertia must be manually set using parameter p1498. The test signal must have been previously set using parameters p5308 and p5309.

For bit 07:
With this function, these axes are adapted to the dynamic response set in p5275. This is necessary for interpolating axes. The time in p5275 should be set according to the axis with the lowest dynamic response.

For bit 08:
Using this bit, the moment of inertia is determined from the frequency characteristic using a test signal, and is transferred to p1498. The traversing path must first be set using parameter p5308.

r5306[0]	One Button Tuning status			
	Data type: Unsigned16		Unit: -	
Description:	Displays the status of the functions performed using One Button Tuning.			
Bit field:	Bit	Signal name	1 signal	0 signal
	00	Proportional gain Kp set	Yes	No
	01	Current setpoint filter set	Yes	No
	02	Moment of inertia estimation carried out	Yes	No
	13	One Button Tuning successfully completed	Yes	No
	14	Controller parameters reset due to fault	Yes	No
Dependency:	See also: p5300, p5301			

Note

For bit 00 = 1: The speed controller gain was set using One Button Tuning.
For bit 01 = 1: The current setpoint filter was set using One Button Tuning
For bit 02 = 1: The moment of inertia was determined.

p5308[0]	One Button Tuning distance limiting			
	Can be changed: T	Data type: Integer32		
	Min: -30000 [°]	Max: 30000 [°]	Def: 0 [°]	
Description:	Setting the distance limiting (permissible traversing range des motor). The traversing range is limited in the positive and negative directions.			

Note

A value of 360 degrees corresponds to one motor revolution.
The position before the pulse enable is used as zero point.

p5309[0]	One Button Tuning duration			
	Can be changed: T	Data type: Unsigned32		
	Min: 0 [ms]	Max: 5000 [ms]	Def: 2000 [ms]	
Description:	Sets the duration for One Button Tuning (several acceleration operations) This function is used for One Button Tuning (p5300 = 1) to identify the total moment of inertia of the drive train.			
Dependency:	See also: F07093			

Note

If, within this time, no setting values can be determined, then the drive is shut down with the corresponding fault.

r5600**Pe energy-saving mode ID**

Data type: Integer16 **Unit:** -

Description: Displays the PROFlenergy mode ID of the effective energy-saving mode.

Value:

0:	POWER OFF
2:	Energy-saving mode
240:	Operation
255:	Ready

Note

Pe: PROFlenergy profiles

For value = 0: This value is displayed in the "First commissioning" state.

p5611**Pe energy-saving properties general**

Can be changed: T **Data type:** Unsigned32

Min: - **Max:** - **Def:** 0000 bin

Description: Sets the general properties for energy-saving.

Bit field:	Bit	Signal name	1 signal	0 signal
	00	Inhibit PROFlenergy control commands	Yes	No

Note

Pe: PROFlenergy profiles

r8936[0...1]**Cyclic connection status**

Data type: Integer16 **Unit:** -

Description: Displays the status of cyclic connections.

Value:

0:	Interrupted
1:	Not connected
2:	Connection starts to be established
3:	Module information expected
4:	Module information received
5:	Module address expected
6:	Module address received
7:	Parameterization data expected
8:	Parameterization data received
9:	Evaluate parameterization data
10:	Connection being established completion expected
11:	Configured controller RUN expected
12:	Configured controller STOP
13:	Configured controller RUN

Index:

[0]	= Controller 1
[1]	= Controller 2

14.2 List of parameters

Note

The parameter is active when the "PROFINET Device" and "EtherNet/IP" protocols are selected (p2030 = 7, 10).
 For PROFINET, the following applies:
 For two connections (Shared Device or system redundancy) the display in the index depends on the sequence in which the connections are established.
 The IP addresses of controllers 1 and 2 are displayed in r8961 and r8962.
 The following states are displayed for system redundancy:
 Primary controller: r8936[x] = 13
 Backup controller: r8936[x] = 11
 If value = 10:
 If the connection remains in this state, then when using PROFINET IRT the following can apply:
 - topology error (incorrect port assignment).
 - synchronization missing.
 For EtherNet/IP, the following applies:
 Only a cyclic connection is possible for EtherNet/IP. Index 0 indicates the status of the cyclic connection.

r8937[0...5]

Cyclic connection diagnostics

Data type: Unsigned32 **Unit:** -

Description:

Display for the cyclic connection diagnostics.

Index:

- [0] = Number of cyclic connections
- [1] = Number of send subslots of all connections
- [2] = Number of send net data (bytes) of all connections
- [3] = Number of receive subslots of all connections
- [4] = Number of receive net data (bytes) of all connections
- [5] = Connection type (RT, IRT)

Note

The parameter is active when the "PROFINET Device" and "EtherNet/IP" protocols are selected (p2030 = 7, 10).
 For PROFINET, the following applies:
 For index [5]:
 Bit 0 = 1: there is at least one RT connection.
 Bit 1 = 1: there is an IRT connection.
 For EtherNet/IP, the following applies:
 For index [1, 3, 5]:
 These indices are not relevant.

p8984[0...1]

Web server interface enable

Can be changed: T **Data type:** Unsigned32 / Binary

Min: - **Max:** - **Def:** [0] 1 , [1] 0

Description:

Setting to enable the interface for access via the web server.

Index:

- [0] = Reserved
- [1] = PROFINET X150

Note

p8984[1] = 65536:
 PROFINET interface X150 is enabled for access to the web server.
 p8984[1] = 0:
 PROFINET interface X150 is blocked for access to the web server.

p9370

SI Motion acceptance test mode

Can be changed: T, U **Data type:** Integer16

Min: 0000 hex **Max:** 00AC hex **Def:** 0000 hex

Description:

Setting to select and deselect the acceptance test mode.

Value:

0: [00 hex] Deselect the acceptance test mode

Dependency: 172: [AC hex] Select the acceptance test mode
See also: A01799

Note

The acceptance test mode can only be selected if the motion monitoring functions integrated in the drive are enabled (p9601.2).

r9371 SI Motion acceptance test status

Data type: Integer16 **Unit:** -

Description: Displays the status of the acceptance test mode.

Value: 0: [00 hex] Acc_mode inactive
12: [0C hex] Acc_mode not possible due to POWER ON fault
13: [0D hex] Acc_mode not possible due to incorrect ID in p9370
15: [0F hex] Acc_mode not possible due to expired Acc_timer
172: [AC hex] Acc_mode active

Dependency: See also: p9370
See also: A01799

p9501 SI Motion enable safety functions

Can be changed: C2(95) **Data type:** Unsigned32

Min: - **Max:** - **Def:** 0000 0000 0000 0000 0000 0000
0000 0000 bin

Description: Sets the enable signals for the safe motion monitoring.

Bit field:	Bit	Signal name	1 signal	0 signal
	00	Enable SOS/SLS	Enable	Inhibit
	16	Enable SSM	Enable	Inhibit
	17	Enable SDI	Enable	Inhibit
	18	Enable SS2E	Enable	Inhibit
	20	Enable SLA	Enable	Inhibit
	24	Enable transfer SLS limit value via PROFIsafe	Enable	Inhibit

Dependency: See also: F01682, F01683

Note

A change only becomes effective after a POWER ON.
SDI: Safe Direction (safe motion direction)
SLA: Safely-Limited Acceleration
SLS: Safely-Limited Speed
SOS: Safe Operating Stop
SS2E: Safe Stop 2 External (Safe Stop 2 with external stop)
SSM: Safe Speed Monitor (safety-relevant feedback signal from the speed monitoring)

p9502 SI Motion axis type

Can be changed: C2(95) **Data type:** Integer16

Min: 0 **Max:** 1 **Def:** 0

Description: Sets the axis type (linear axis or rotary axis/spindle).

Value: 0: Linear axis
1: Rotary axis/spindle

Note

For the commissioning tool, after changing over the axis type, the units dependent on the axis type are only updated after a project upload.
A change only becomes effective after a POWER ON.

14.2 List of parameters

p9505 **SI Motion SP modulo value**
Can be changed: C2(95) **Data type:** FloatingPoint32
Min: 0 [°] **Max:** 737280 [°] **Def:** 0 [°]

Description: Sets the modulo value in degrees for rotary axes.
This setting is only used to correctly display the diagnostics information in r9708.
The value should be set so that it is precisely at 2ⁿ revolutions, so that when the range that can be represented (+/-2048) overflows, this does not cause the position actual value to jump.
The modulo function is deactivated for a value = 0.

Dependency: See also: p9501
See also: F01681

Note
SP: Safe Position

p9506 **SI Motion function specification**
Can be changed: C2(95) **Data type:** Integer16
Min: 0 **Max:** 2 **Def:** 0

Description: Sets the function specification for the safe motion monitoring.

Value: 0: Safety with encoder and acceleration monitoring (SAM)
2: Safety with encoder with brake ramp (SBR)

Dependency: See also: A01711

Note
A change only becomes effective after a POWER ON.
SAM: Safe Acceleration Monitor (safe acceleration monitoring)
SBR: Safe Brake Ramp (safe brake ramp monitoring)
SI: Safety Integrated

p9507 **SI Motion function configuration**
Can be changed: C2(95) **Data type:** Unsigned32
Min: - **Max:** - **Def:** 0100 0001 bin

Description: Sets the function configuration for the safe motion monitoring functions.

Bit field:	Bit	Signal name	1 signal	0 signal
	00	Extended message acknowledgment	Yes	No
	01	Setpoint speed limiting for A01711	No	Yes
	03	SS1 with OFF3 (brake response)	SS1E external stop	SS1 with OFF3

Dependency: See also: A01711

Note
For bit 00:
When the function is activated, a safety-relevant acknowledgment (internal event acknowledge) can be performed by selecting/deselecting STO.
For bit 01:
When the function is activated, the active setpoint velocity limiting (r9733) for active A01711 is set to zero.
For bit 03:
When the bit is activated, for a fault response with SS1 or when SS1 is selected, an SS1E is initiated. As a consequence, brake monitoring (SBR, SAM) is deactivated.
SS1: Safe Stop 1
SS1E: Safe Stop 1 external (Safe Stop 1 with external stop)
STO: Safe Torque Off

p9515	SI Motion encoder coarse position value configuration		
	Can be changed: C2(95)	Data type: Unsigned32	
	Min: -	Max: -	Def: 0000 0000 0000 0000 0000 0000 0000 0000 bin
Description:	Sets the encoder configuration for the redundant coarse position value. The encoder that is used for the safe motion monitoring function must be parameterized in this parameter.		
Bit field:	Bit	Signal name	1 signal 0 signal
	00	Incrementer	Yes No
	01	Encoder CRC least significant byte first	Yes No
	02	Redundant coarse position val. most significant bit left-aligned	Yes No
	04	Binary comparison not possible	Yes No
	05	Single-channel encoder	Yes No
	16	DRIVE-CLiQ encoder	Yes No
	Note		
	- after starting the copy function (p9700 = 57 hex), p9515.0...5 are set according to the encoder. For safety functions that are not enabled (p9501 = 0), the following applies: - p9515.16 is automatically set when the system powers up. For safety functions that are enabled (p9501 > 0), the following applies: - p9515.16 is checked to see that it matches the encoder.		
p9516	SI Motion encoder configuration safety functions		
	Can be changed: C2(95)	Data type: Unsigned16	
	Min: -	Max: -	Def: 0000 0000 bin
Description:	Sets the configuration for the motor encoder and position actual value. The encoder that is used for the safe motion monitoring function must be parameterized in this parameter.		
Bit field:	Bit	Signal name	1 signal 0 signal
	01	Position actual value sign change	Yes No
	04	No STO after encoder fault	Yes No
Dependency:	See also: F01671		
p9518	SI Motion encoder pulses per revolution		
	Can be changed: C2(95)	Data type: Unsigned32	
	Min: 0	Max: 16777215	Def: 2048
Description:	Sets the number of encoder pulses per revolution. The encoder that is used for the safe motion monitoring function must be parameterized in this parameter.		
Dependency:	See also: F01671		
	Note		
	For safety functions that are not enabled (p9501 = 0), the following applies: - p9518 is automatically set when the system powers up. For safety functions that are enabled (p9501 > 0), the following applies: - p9518 is checked to see that it matches the encoder.		
p9519	SI Motion fine resolution G1_XIST1		
	Can be changed: C2(95)	Data type: Unsigned32	
	Min: 2	Max: 18	Def: 11
Description:	Sets the fine resolution for G1_XIST1 in bits. The encoder that is used for the safe motion monitoring function must be parameterized in this parameter.		
Dependency:	See also: F01671		

14.2 List of parameters

Note

G1_XIST1: encoder 1 position actual value 1 (PROFIdrive)
 For safety functions that are not enabled (p9501 = 0), the following applies:
 - p9519 is automatically set when the system powers up.
 For safety functions that are enabled (p9501 > 0), the following applies:
 - p9519 is checked to see that it matches the encoder.

p9520 **SI Motion spindle pitch**
Can be changed: C2(95) **Data type:** FloatingPoint32
Min: 0.1000 [mm] **Max:** 8388.0000 [mm] **Def:** 10.0000 [mm]
Description: Sets the gear ratio between the encoder and load in mm/revolution for a linear axis with rotary encoder.

NOTICE
 The fourth decimal point can be rounded-off depending on the size of the entered number (from 3 places before the decimal point).

p9521[0...7] **SI Motion gearbox encoder (motor)/load denominator**
Can be changed: C2(95) **Data type:** Unsigned32
Min: 1 **Max:** 2147000000 **Def:** 1
Description: Sets the denominator for the gearbox between the encoder and load.
Index: [0] = Gearbox 1
 [1...7] = Reserved
Dependency: See also: p9522

p9522[0...7] **SI Motion gearbox encoder (motor)/load numerator**
Can be changed: C2(95) **Data type:** Unsigned32
Min: 1 **Max:** 2147000000 **Def:** 1
Description: Sets the numerator for the gearbox between the encoder and load.
Index: [0] = Gearbox 1
 [1...7] = Reserved
Dependency: See also: p9521

p9530 **SI Motion standstill tolerance**
Can be changed: C2(95) **Data type:** FloatingPoint32
Min: 0.000 [mm] **Max:** 100.000 [mm] **Def:** 1.000 [mm]
Min: 0.000 [°] **Max:** 100.000 [°] **Def:** 1.000 [°]
Description: Sets the tolerance for the "SOS" function.
Dependency: See also: A01707

Note

SOS: Safe Operating Stop

p9531[0...3] **SI Motion SLS limit values**
Can be changed: C2(95) **Data type:** FloatingPoint32
Min: 0.00 [mm/min] **Max:** 1000000.00 [mm/min] **Def:** 2000.00 [mm/min]
Min: 0.00 [rpm] **Max:** 1000000.00 [rpm] **Def:** 2000.00 [rpm]
Description: Sets the limit values for the "SLS" function.
Index: [0] = Limit value SLS1
 [1] = Limit value SLS2
 [2] = Limit value SLS3
 [3] = Limit value SLS4

Dependency: See also: p9563
See also: A01714

Note

SLS: Safely-Limited Speed

p9533**SI Motion SLS setpoint speed limiting**

Can be changed: T, U

Data type: FloatingPoint32

Min: 0.000 [%]

Max: 100.000 [%]

Def: 80.000 [%]

Description:

This is an evaluation factor to define the setpoint limit from the selected actual speed limit.
The active SLS limit value is evaluated with this factor and is made available as setpoint limit in r9733.

Dependency:

This parameter only has to be parameterized for the motion monitoring functions integrated in the drive ($p9601.2 = 1$)
 $r9733[0] = p9531[x] \times p9533$ (converted from the load side to the motor side)
 $r9733[1] = - p9531[x] \times p9533$ (converted from the load side to the motor side)
 $[x]$ = Selected SLS stage
 Conversion factor from the motor side to the load side:
 - motor type = rotary and axis type = linear: $p9522 / (p9521 \times p9520)$
 - otherwise: $p9522 / p9521$
 See also: p9501, p9531, p9601

Note

The active actual speed limit is selected via safety-relevant inputs.
When SOS is selected or an STO, SS1, SS2, SS2E, a setpoint of 0 is entered in r9733.
SLS: Safely-Limited Speed

p9539[0...7]**SI Motion gearbox direction of rotation reversal**

Can be changed: C2(95)

Data type: Integer16

Min: 0

Max: 1

Def: 0

Description:

Sets the direction of rotation reversal for the gearbox.
0: No direction of rotation reversal
1: Direction of rotation reversal

Index:

[0] = Gearbox 1
[1...7] = Reserved

Dependency:

See also: p9521

p9542**SI Motion actual value comparison tolerance (cross-check)**

Can be changed: C2(95)

Data type: FloatingPoint32

Min: 0.0010 [mm]

Max: 360.0000 [mm]

Def: 0.1000 [mm]

Min: 0.0010 [°]

Max: 360.0000 [°]

Def: 0.1000 [°]

Description:

Sets the tolerance for the data cross-check of the actual position between the two monitoring channels.

Dependency:

See also: A01711

Note

For a "linear axis with rotating motor" and factory setting of p9520, p9521 and p9522, the factory setting of p9542 corresponds to a position tolerance of 36 ° on the motor side.

p9545**SI Motion SSM filter time**

Can be changed: C2(95)

Data type: FloatingPoint32

Min: 0.00 [ms]

Max: 500.00 [ms]

Def: 0.00 [ms]

Description:

Sets the filter time for the SSM feedback signal to detect standstill.

14.2 List of parameters

Note

The filter time is effective only if the function is enabled (p9501.16 = 1).
 The parameter is included in the data cross-check of the two monitoring channels.
 The set time is rounded internally to an integer multiple of the monitoring clock cycle.
 SSM: Safe Speed Monitor (safety-relevant feedback signal from the speed monitoring)

p9546**SI Motion SSM velocity limit****Can be changed:** C2(95)**Data type:** FloatingPoint32**Min:** 0.00 [mm/min]**Max:** 1000000.00 [mm/min]**Def:** 20.00 [mm/min]**Min:** 0.00 [rpm]**Max:** 1000000.00 [rpm]**Def:** 20.00 [rpm]**Description:**

Sets the velocity limit for the SSM feedback signal to detect standstill.
 When this limit value is undershot, the signal "SSM feedback signal active" is set.
 For p9568 = 0, the value in p9546 is also applicable for SAM/SBR.

Note

SAM: Safe Acceleration Monitor (safe acceleration monitoring)
 SBR: Safe Brake Ramp (safe brake ramp monitoring)
 SSM: Safe Speed Monitor (safety-relevant feedback signal from the speed monitoring)

p9547**SI Motion SSM velocity hysteresis****Can be changed:** C2(95)**Data type:** FloatingPoint32**Min:** 0.0010 [mm/min]**Max:** 500.0000 [mm/min]**Def:** 10.0000 [mm/min]**Min:** 0.0010 [rpm]**Max:** 500.0000 [rpm]**Def:** 10.0000 [rpm]**Description:**

Sets the velocity hysteresis for the SSM feedback signal to detect standstill.

Dependency:

See also: A01711

Note

The velocity hysteresis is effective only if the function is enabled (p9501.16 = 1).
 The parameter is included in the data cross-check of the two monitoring channels.
 SSM: Safe Speed Monitor (safety-relevant feedback signal from the speed monitoring)

p9548**SI Motion SAM actual speed tolerance****Can be changed:** C2(95)**Data type:** FloatingPoint32**Min:** 0.00 [mm/min]**Max:** 120000.00 [mm/min]**Def:** 300.00 [mm/min]**Min:** 0.00 [rpm]**Max:** 120000.00 [rpm]**Def:** 300.00 [rpm]**Description:**

Sets the velocity tolerance for the "SAM" function.

Dependency:

See also: A01706

Note

SAM: Safe Acceleration Monitor (safe acceleration monitoring)

p9551**SI Motion SLS switchover/SOS delay time****Can be changed:** C2(95)**Data type:** FloatingPoint32**Min:** 0.00 [ms]**Max:** 600000.00 [ms]**Def:** 100.00 [ms]**Description:**

Sets the delay time for the SLS changeover and for the activation of SOS for the "SLS" and "SOS" functions.
 When transitioning from a higher to a lower Safely-Limited Speed level, and when activating SOS, within this delay time, the "old" speed level remains active.
 This delay is also applicable when activating SLS from the state "SOS and SLS inactive" and activating SOS from the state "SOS inactive".

Note

The set time is rounded internally to an integer multiple of the monitoring clock cycle.

SLS: Safely-Limited Speed

SOS: Safe Operating Stop

p9552**SI Motion transition time SS2 to SOS**

Can be changed: C2(95)

Data type: FloatingPoint32

Min: 0.00 [ms]

Max: 600000.00 [ms]

Def: 100.00 [ms]

Description:

Sets the transition time from SS2 to SOS.

Note

The set time is rounded internally to an integer multiple of the monitoring clock cycle.

SOS: Safe Operating Stop

SS2: Safe Stop 2

p9553**SI Motion transition time SS2E to SOS**

Can be changed: C2(95)

Data type: FloatingPoint32

Min: 0.00 [ms]

Max: 600000.00 [ms]

Def: 100.00 [ms]

Description:

Sets the transition time from SS2E to SOS.

Note

The set time is rounded internally to an integer multiple of the monitoring clock cycle.

SI: Safety Integrated

SOS: Safe Operating Stop

SS2E: Safe Stop 2 External (Safe Stop 2 with external stop)

p9555**SI Motion transition time F01711 to SS1**

Can be changed: C2(95)

Data type: FloatingPoint32

Min: 0.00 [ms]

Max: 600000.00 [ms]

Def: 0.00 [ms]

Description:

Sets the transition time from F01711 to SS1.

Dependency:

See also: A01711

Note

The set time is rounded internally to an integer multiple of the monitoring clock cycle.

p9556**SI Motion SS1 to STO delay time**

Can be changed: C2(95)

Data type: FloatingPoint32

Min: 0.00 [ms]

Max: 3600000.00 [ms]

Def: 100.00 [ms]

Description:

Sets the delay time for STO after an SS1.

Dependency:

See also: p9560

See also: F01701

Note

The set time is rounded internally to an integer multiple of the monitoring clock cycle.

p9557**SI Motion STO test time**

Can be changed: C2(95)

Data type: FloatingPoint32

Min: 0.00 [ms]

Max: 10000.00 [ms]

Def: 100.00 [ms]

Description:

Sets the time after which STO must be active when initiating the test stop.

Dependency:

See also: A01798

14.2 List of parameters

Note

The set time is rounded internally to an integer multiple of the monitoring clock cycle.
STO: Safe Torque Off

p9558**SI Motion acceptance test mode, time limit****Can be changed:** C2(95)**Data type:** FloatingPoint32**Min:** 5000.00 [ms]**Max:** 100000.00 [ms]**Def:** 40000.00 [ms]**Description:**

Sets the maximum time for the acceptance test mode.

If the acceptance test mode takes longer than the selected time limit, then the mode is automatically terminated.

Dependency:

See also: A01799

Note

The set time is rounded internally to an integer multiple of the monitoring clock cycle.

p9559**SI Motion forced checking procedure timer****Can be changed:** C2(95)**Data type:** FloatingPoint32**Min:** 0.00 [h]**Max:** 9000.00 [h]**Def:** 8600.00 [h]**Description:**

Sets the time interval for carrying out the forced checking procedure and testing the safety motion monitoring functions integrated in the drives.

Within the parameterized time, the safety functions must have been tested at least once (including deselection of the "STO" function).

This monitoring time is reset each time the test is carried out.

The signal source to initiate the forced checking procedure is set in p9705.

Dependency:

See also: A01697, A01798

Note

STO: Safe Torque Off

p9560**SI Motion STO shutdown speed****Can be changed:** C2(95)**Data type:** FloatingPoint32**Min:** 0.00 [mm/min]**Max:** 6000.00 [mm/min]**Def:** 0.00 [mm/min]**Min:** 0.00 [rpm]**Max:** 6000.00 [rpm]**Def:** 0.00 [rpm]**Description:**

Sets the shutdown velocity for activating STO.

Below this velocity, "standstill" is assumed, and for an SS1, STO is selected.

Dependency:

See also: p9556

Note

The shutdown velocity has no effect for a value = 0.

SS1: Safe Stop 1

STO: Safe Torque Off

p9563[0...3]**SI Motion SLS-specific stop response****Can be changed:** C2(95)**Data type:** Integer16**Min:** 0**Max:** 3**Def:** 1**Description:**

Sets the SLS-specific stop response for the SLS function.

These settings apply to the individual limit values for SLS.

An input value of less than 5 signifies personnel protection, from 10 and upwards, machine protection.

Value:

0: STO

1: SS1

2: SS2

3: SS2E

Index: [0] = Limit value SLS1
 [1] = Limit value SLS2
 [2] = Limit value SLS3
 [3] = Limit value SLS4

Dependency: See also: p9531

Note

In an extended sense, bus failure is interpreted here as a communication error in the control signals of the safety functions (e.g. via PROFIsafe).

SI: Safety Integrated

SLS: Safely-Limited Speed

SS1: Safe Stop 1

SS2: Safe Stop 2

SS2E: Safe Stop 2 External (Safe Stop 2 with external stop)

STO: Safe Torque Off

p9564**SI Motion SDI tolerance**

Can be changed: C2(95)

Data type: FloatingPoint32

Min: 0.001 [mm]

Max: 360.000 [mm]

Def: 12.000 [mm]

Min: 0.001 [°]

Max: 360.000 [°]

Def: 12.000 [°]

Description: Sets the tolerance for the "SDI" function.

This motion in the monitored direction is still permissible before message A01716 is initiated.

Dependency: See also: p9565, p9566

See also: A01716

Note

SDI: Safe Direction (safe motion direction)

p9565**SI Motion SDI delay time**

Can be changed: C2(95)

Data type: FloatingPoint32

Min: 0.00 [ms]

Max: 600000.00 [ms]

Def: 100.00 [ms]

Description: Sets the delay time for the "SDI" function.

After selecting the SDI function, then for a maximum of this time, motion in the monitored direction is permissible. This time can therefore be used for braking any motion.

Dependency: See also: p9564, p9566

See also: A01716

Note

The set time is rounded internally to an integer multiple of the monitoring clock cycle.

SDI: Safe Direction (safe motion direction)

p9566**SI Motion SDI stop response**

Can be changed: C2(95)

Data type: Integer16

Min: 0

Max: 3

Def: 1

Description: Sets the stop response for the SDI function.

This setting applies to both directions of motion.

Value: 0: STO

1: SS1

2: SS2

3: SS2E

Dependency: See also: p9564, p9565

See also: A01716

14.2 List of parameters

Note

In an extended sense, bus failure is interpreted here as a communication fault in the control signals of the safety functions (e.g. via PROFIsafe).

SDI: Safe Direction (safe motion direction)

p9568**SI Motion SAM/SBR speed limit****Can be changed:** C2(95)**Data type:** FloatingPoint32**Min:** 0.00 [mm/min]**Max:** 1000.00 [mm/min]**Def:** 0.00 [mm/min]**Min:** 0.00 [rpm]**Max:** 1000.00 [rpm]**Def:** 0.00 [rpm]**Description:**

Sets the velocity limit for the "SAM" and "SBR" functions.

If the drive accelerates during the down ramp by the tolerance in p9548, then SAM identifies this and STO is initiated.

The monitoring operates as follows:

- SAM monitoring is activated for SS1 and SS2.
- the SAM limit value is frozen after the velocity limit in p9568 is undershot.
- SAM monitoring is still executed until the transition time to SOS/STO has expired.

Note

For p9568 = 0, the following applies:

The value in p9546 (SSM) is applied as the velocity limit for SAM/SBR.

SAM: Safe Acceleration Monitor (safe acceleration monitoring)

SBR: Safe Brake Ramp (safe brake ramp monitoring)

SSM: Safe Speed Monitor (safety-relevant feedback signal from the speed monitoring)

p9570**SI Motion acceptance test mode****Can be changed:** T, U**Data type:** Integer16**Min:** 0000 hex**Max:** 00AC hex**Def:** 0000 hex**Description:**

Setting to select and deselect the acceptance test mode.

Value:

0: [00 hex] Deselect the acceptance test mode

172: [AC hex] Select the acceptance test mode

Dependency:

See also: p9558, r9571, p9601

See also: A01799

Note

Acceptance test mode can only be selected if the safe motion monitoring functions are enabled.

r9571**SI Motion acceptance test status****Data type:** Integer16**Unit:** -**Description:**

Displays the status of the acceptance test mode.

Value:

0: [00 hex] Acc_mode inactive

12: [0C hex] Acc_mode not possible due to POWER ON fault

13: [0D hex] Acc_mode not possible due to incorrect ID in p9570

15: [0F hex] Acc_mode not possible due to expired Acc_timer

172: [AC hex] Acc_mode active

Dependency:

See also: p9558, p9570

See also: A01799

p9576**SI Motion SLA filter time****Can be changed:** C2(95)**Data type:** FloatingPoint32**Min:** 0.00 [ms]**Max:** 500.00 [ms]**Def:** 0.00 [ms]**Description:**

Sets the filter time for the acceleration monitoring with a fine resolution of the acceleration.

Note

The filter time is only effective if the function is enabled (p9501.20 = 1).
 The set time is rounded internally to an integer multiple of the monitoring clock cycle.
 The parameter is included in the data cross-check of the two monitoring channels.
 SLA: Safely-Limited Acceleration

p9578**SI Motion SLA acceleration limit****Can be changed:** C2(95)**Data type:** FloatingPoint32**Min:** 0.00 [m/s²]**Max:** 1000.00 [m/s²]**Def:** 1.00 [m/s²]**Min:** 0.00 [rev/s²]**Max:** 1000.00 [rev/s²]**Def:** 1.00 [rev/s²]**Description:**

Sets the acceleration limit for the "Safely-Limited Acceleration" function (SLA).

Dependency:

See also: p9579

Note

The set time is rounded internally to an integer multiple of the monitoring clock cycle.
 SLA: Safely-Limited Acceleration

p9579**SI Motion SLA stop response****Can be changed:** C2(95)**Data type:** Integer16**Min:** 0**Max:** 3**Def:** 1**Description:**

Sets the stop response for the "Safely-Limited Acceleration" function (SLA).

Value:

0: STO
 1: SS1
 2: SS2
 3: SS2E

Dependency:

See also: p9578

Note

The set time is rounded internally to an integer multiple of the monitoring clock cycle.
 SLA: Safely-Limited Acceleration

p9581**SI Motion brake ramp reference value****Can be changed:** C2(95)**Data type:** FloatingPoint32**Min:** 600.0000 [mm/min]**Max:** 240000.0000 [mm/min]**Def:** 1500.0000 [mm/min]**Min:** 600.0000 [rpm]**Max:** 240000.0000 [rpm]**Def:** 1500.0000 [rpm]**Description:**

Sets the reference value to define the brake ramp.
 The rate of rise of the brake ramp depends upon p9581 (reference value) and p9583 (monitoring time).

Dependency:

See also: p9582, p9583

p9582**SI Motion brake ramp delay time****Can be changed:** C2(95)**Data type:** FloatingPoint32**Min:** 10.00 [ms]**Max:** 99000.00 [ms]**Def:** 250.00 [ms]**Description:**

Sets the delay time for monitoring the brake ramp.
 Monitoring of the brake ramp starts once the delay time has elapsed.

Dependency:

See also: p9581, p9583

Note

The set time is rounded internally to an integer multiple of the monitoring clock cycle.
 The set time is internally limited (lower limit) to 2 safety monitoring clock cycles.

14.2 List of parameters

p9583	SI Motion brake ramp monitoring time		
	Can be changed: C2(95)	Data type: FloatingPoint32	
	Min: 0.50 [s]	Max: 3600.00 [s]	Def: 10.00 [s]
Description:	Sets the monitoring time to define the brake ramp. The rate of rise of the brake ramp depends upon p9581 (reference value) and p9583 (monitoring time).		
Dependency:	See also: p9581, p9582		
	Note The set time is rounded internally to an integer multiple of the monitoring clock cycle.		

r9590[0...3]	SI Motion version, safe motion monitoring functions		
	Data type: Unsigned16	Unit: -	
Description:	Displays the Safety Integrated version for the safe monitoring functions.		
Index:	[0] = Safety Version (major release) [1] = Safety Version (minor release) [2] = Safety Version (baselevel or patch) [3] = Safety Version (hotfix)		
Dependency:	See also: r9770		
	Note Example: r9590[0] = 5, r9590[1] = 10, r9590[2] = 1, r9590[3] = 0 --> SI Motion version V05.10.01.00		

p9601	SI enable, functions integrated in the drive		
	Can be changed: C2(95)	Data type: Unsigned32	
	Min: -	Max: -	Def: 0000 bin
Description:	Sets the enable signals for the safety functions integrated in the drive and the type of selection. Only a selection of the subsequently listed settings is permissible: 0000 hex: Safety functions integrated in the drive inhibited (no safety function). 0001 hex: Basis functions are enabled via the onboard terminals. 0008 hex: Basis functions are enabled via PROFIsafe. 0009 hex: Basis functions are enabled via PROFIsafe and onboard terminals. 000C hex: Extended functions via PROFIsafe are enabled. 000D hex: Extended functions via PROFIsafe and basic functions via onboard terminals are enabled.		
Bit field:	Bit	Signal name	1 signal 0 signal
	00	STO enabled via terminals:	Enable Inhibit
	02	Enable motion monitoring functions integrated in drive	Enable Inhibit
	03	Enable PROFIsafe	Enable Inhibit
	Note A change always becomes effective only after a POWER ON. Exception: A change to p9601.0 takes effect immediately. STO: Safe Torque Off SS1: Safe Stop 1 SI: Safety Integrated		

p9602	SI enable safe brake control	Can be changed: C2(95)	Data type: Integer16	
		Min: 0	Max: 1	Def: 0
Description:	Sets the enable for the "SBC" function.			
Value:	0: Inhibit SBC 1: Enable SBC			
	Note The "SBC" function is not activated until at least one safety monitoring function has been enabled (i.e. p9501 not equal to 0 and/or p9601 not equal to 0). The parameterization "No motor holding brake available" and "Safe Brake Control" enabled (p1215 = 0, p9602 = 1) does not make sense if a motor holding brake is not being used. SBC: Safe Brake Control SI: Safety Integrated			
p9610	SI PROFIsafe address	Can be changed: C2(95)	Data type: Unsigned16	
		Min: 0	Max: 65534	Def: 0
Description:	Sets the PROFIsafe address.			
	Note A change only becomes effective after a POWER ON. The PROFIsafe address in the drive must be identical with the address in the control.			
p9611	SI PROFIsafe telegram selection	Can be changed: C2(95)	Data type: Unsigned16	
		Min: 0	Max: 901	Def: 0
Description:	Sets the PROFIsafe telegram number.			
Value:	0: No PROFIsafe telegram selected 30: PROFIsafe standard telegram 30, PZD-1/1 901: PROFIsafe SIEMENS telegram 901, PZD-3/5			
Dependency:	See also: r60022			
	Note A change only becomes effective after a POWER ON. To select the PROFIdrive telegram, PROFIsafe must have been enabled (p9601.3 = 1).			
p9612	SI PROFIsafe failure response	Can be changed: C2(95)	Data type: Integer16	
		Min: 0	Max: 1	Def: 0
Description:	Sets the stop response when PROFIsafe communication fails.			
Value:	0: STO 1: SS1			
	Note For p9612 = 0 (STO): The drive safely switches off the motor, the motor coasts down. For p9612 = 1 (SS1): The drive brakes the motor with OFF3 ramp-down time until standstill is detected. A switchover is then made to STO. The following must be observed: - the transition time F01611 to STO (p9658) must be set higher or equal to the delay time (p9652).			

14.2 List of parameters

p9650	SI F-DI discrepancy time Can be changed: C2(95) Data type: FloatingPoint32 Min: 0.00 [ms] Max: 2000.00 [ms] Def: 500.00 [ms]
Description:	Sets the time during which the drive tolerates different signal states of the failsafe digital input.
	Note F-DI: Failsafe Digital Input
p9651	SI STO/SBC/SS1 t_debounce time Can be changed: C2(95) Data type: FloatingPoint32 Min: 0.00 [ms] Max: 100.00 [ms] Def: 0.00 [ms]
Description:	Sets the debounce time for the failsafe digital input used to control STO/SBC/SS1. The debounce time specifies the duration of a fault (noise) pulse at a failsafe digital input that does not change the drive state.
	Note The debounce time is rounded to whole milliseconds. Example: Debounce time = 1 ms: Fault pulses of 1 ms are tolerated; only pulses longer than 2 ms result in a response. Debounce time = 3 ms: Fault pulses of 3 ms are tolerated; only pulses longer than 4 ms result in a response. The set debounce time impacts the response time of the safety function.
p9652	SI SS1 delay time Can be changed: C2(95) Data type: FloatingPoint32 Min: 0.00 [s] Max: 300.00 [s] Def: 0.00 [s]
Description:	Sets the delay time of the pulse suppression for the "Safe Stop 1" (SS1) function to brake along the OFF3 down ramp (p1135).
Recommendation:	In order that the drive can completely ramp-down along the OFF3 ramp and a motor holding brake that is possibly available can close, then the delay time should be set as follows: Motor holding brake parameterized: delay time \geq p1135 + p1228 + p1217 Motor holding brake not parameterized: delay time \geq p1135 + p1228
Dependency:	See also: p1135
	Note For a stop response SS1 set for PROFIsafe failure (p9612 = 1), pulse cancellation after failure of PROFIsafe communication is delayed by this time. SS1: Safe Stop 1
p9653	SI SS1 drive-based braking response Can be changed: C2(95) Data type: Integer16 Min: 0 Max: 1 Def: 0
Description:	Sets the drive-based braking response for the "SS1" function. In the factory setting, SS1 uses the OFF3 ramp.
Value:	0: SS1 with OFF3 1: SS1E external stop
	Note For p9653 = 1, a switchover is made from SS1 to SS1E - and the SS1 response is transferred to the control system. SS1E requires the externally initiated stop in order to be in conformance with stop Category 1 according to EN60204. SS1: Safe Stop 1 SS1E: Safe Stop 1 external (Safe Stop 1 with external stop)

p9658	SI transition time F01611 to STO Can be changed: C2(95) Data type: FloatingPoint32 Min: 0.00 [ms] Max: 30000.00 [ms] Def: 0.00 [ms]
Description:	Sets the transition time from F01611 to STO.
Dependency:	See also: r9795 See also: F01611
	Note The set time is rounded internally to an integer multiple of the monitoring clock cycle. STO: Safe Torque Off
p9659	SI forced checking procedure timer Can be changed: C2(95) Data type: FloatingPoint32 Min: 0.00 [h] Max: 9000.00 [h] Def: 8760.00 [h]
Description:	Setting the time interval in order to test Safe Torque Off (STO). During the test, within the parameterized time, an STO is selected and then again deselected, e.g. by activating and deactivating Emergency Stop. The monitoring time in r9660 is reset each time that STO is deselected.
Dependency:	See also: A01699
	Note STO: Safe Torque Off
r9660	SI forced checking procedure remaining time Data type: FloatingPoint32 Unit: [h]
Description:	Displays the remaining time until the next forced checking procedure of the safety functions.
Dependency:	See also: A01699
p9670	SI module identification drive Can be changed: T Data type: Unsigned32 Min: 0 Max: 4294967295 Def: 0
Description:	Safety Integrated module identifier for the drive. Replacement of the drive is identified when the safety functions are activated.
Dependency:	See also: F01641
	Note After replacement, when the drive powers up a fault is output.
p9673	SI module identifier motor encoder evaluation Can be changed: T Data type: Unsigned32 Min: 0 Max: 4294967295 Def: 0
Description:	Safety Integrated module identifier for the encoder in the motor. Replacement of the motor is identified when the safety functions are activated.
Dependency:	See also: F01641
	Note After replacement, when the drive powers up a fault is output.
p9675	SI module identifier motor encoder Can be changed: T Data type: Unsigned32 Min: 0 Max: 4294967295 Def: 0

r9710[0...1]**SI Motion diagnostics result list 1****Data type:** Unsigned32 **Unit:** -**Description:** Displays result list 1 that, for the data cross-check between the monitoring channels, led to the fault.**Index:** [0] = Result list channel 2

[1] = Result list channel 1

Bit field:

Bit	Signal name	1 signal	0 signal
00	Actual value > upper limit SOS	Yes	No
01	Actual value > lower limit SOS	Yes	No
06	Actual value > upper limit SLS1	Yes	No
07	Actual value > lower limit SLS1	Yes	No
08	Actual value > upper limit SLS2	Yes	No
09	Actual value > lower limit SLS2	Yes	No
10	Actual value > upper limit SLS3	Yes	No
11	Actual value > lower limit SLS3	Yes	No
12	Actual value > upper limit SLS4	Yes	No
13	Actual value > lower limit SLS4	Yes	No
14	Actual value > upper limit test stop	Yes	No
15	Actual value > lower limit test stop	Yes	No
16	Actual value > upper limit SAM/SBR	Yes	No
17	Actual value > lower limit SAM/SBR	Yes	No
18	Actual value > upper limit SDI positive	Yes	No
19	Actual value > lower limit SDI positive	Yes	No
20	Actual value > upper limit SDI negative	Yes	No
21	Actual value > lower limit SDI negative	Yes	No
22	Actual value > upper limit SLA1	Yes	No
23	Actual value > lower limit SLA1	Yes	No
24	Actual value > fine upper limit SLA1	Yes	No
25	Actual value > fine lower limit SLA1	Yes	No

Dependency: See also: A01711**Note**

SBR: Safe Brake Ramp (safe brake ramp monitoring)

SDI: Safe Direction (safe motion direction)

SLA: Safely-Limited Acceleration

SLS: Safely-Limited Speed

SOS: Safe Operating Stop

r9711[0...1]**SI Motion diagnostics result list 2****Data type:** Unsigned32 **Unit:** -**Description:** Displays result list 2 that, for the data cross-check between the monitoring channels, led to the fault.**Index:** [0] = Result list channel 2

[1] = Result list channel 1

Bit field:

Bit	Signal name	1 signal	0 signal
16	Actual value > upper limit SSM+	Yes	No
17	Actual value > lower limit SSM+	Yes	No
18	Actual value > upper limit SSM-	Yes	No
19	Actual value > lower limit SSM-	Yes	No
20	Actual value > upper limit modulo	Yes	No
21	Actual value > lower limit modulo	Yes	No

Dependency: See also: A01711

r9720.0...28 SI Motion control signals integrated in the drive**Data type:** Unsigned32 **Unit:** -**Description:** Control signals for safety-relevant motion monitoring functions integrated in the drive.

Bit field:	Bit	Signal name	1 signal	0 signal
	00	Deselect STO	Yes	No
	01	Deselect SS1	Yes	No
	02	Deselect SS2	Yes	No
	03	Deselect SOS	Yes	No
	04	Deselect SLS	Yes	No
	07	Acknowledgment	Signal edge active	No
	08	Deselect SLA	Yes	No
	09	Select SLS bit 0	Set	Not set
	10	Select SLS bit 1	Set	Not set
	12	Deselect SDI positive	Yes	No
	13	Deselect SDI negative	Yes	No
	28	Deselect SS2E	Yes	No

Note

This parameter is only supplied with actual values in the case of Safety Integrated Extended Functions. For Safety Integrated Basic Functions (SBC, SS1, STO), the value is equal to zero.

r9722.0...28 SI Motion drive-integrated status signals**Data type:** Unsigned32 **Unit:** -**Description:** Status signal for safety-relevant motion monitoring functions integrated in the drive.

Bit field:	Bit	Signal name	1 signal	0 signal
	00	STO or safe pulse suppression active	Yes	No
	01	SS1 active	Yes	No
	02	SS2 active	Yes	No
	03	SOS active	Yes	No
	04	SLS active	Yes	No
	07	Internal event	No	Yes
	08	SLA active	Yes	No
	09	Active SLS stage bit 0	Set	Not set
	10	Active SLS stage bit 1	Set	Not set
	11	SOS selected	Yes	No
	12	SDI positive active	Yes	No
	13	SDI negative active	Yes	No
	15	SSM (speed below limit value)	Yes	No
	28	SS2E active	Yes	No

Dependency: See also: p9501**NOTICE**

For bit 07:

The signal state behaves in an opposite way to the PROFIsafe Standard.

For bit 07:

An internal event is displayed if a fault response STO, SS1, SS2, SS2E, A01711 is active.

For bit 15:

This bit is only supplied for activated SSM hysteresis and filtering (p9501.16 = 1).

14.2 List of parameters

Note

For bit 07:

The signal state behaves in an opposite way to the PROFIsafe Standard.

For bit 07:

An internal event is displayed if a fault response STO, SS1, SS2, SS2E, A01711 is active.

For bit 15:

This bit is only supplied for activated SSM hysteresis and filtering (p9501.16 = 1).

r9723.0...16

SI Motion diagnostic signals integrated in the drive

Data type: Unsigned32 **Unit:** -

Description: Displays the diagnostic signals for safety-relevant motion monitoring functions integrated in the drive.

Bit field:	Bit	Signal name	1 signal	0 signal
	00	Forced checking procedure required	Yes	No
	01	A01711 and then SS1 becomes active	Yes	No
	02	Communication failure delay time active	Yes	No
	03	Actual value sensing supplies valid value	Yes	No
	12	Test stop active	Yes	No
	16	SAM/SBR active	Yes	No

Note

For bit 00:

A required dynamization is also displayed using alarm A01679.

For bit 01:

This bit can be used to execute a control-managed response (e.g. emergency retraction).

For bit 02:

This bit is set if communication fails and the delay time of the stop response is running.

For bit 12:

Test stop active, is also displayed using message A01798.

SAM: Safe Acceleration Monitor (safe acceleration monitoring)

SBR: Safe Brake Ramp (safe brake ramp monitoring)

r9725[0...2]

SI Motion diagnostics A01711

Data type: Unsigned32 **Unit:** -

Description:

For index [0]:

Displays the message value that resulted in message A01711 at the drive.

Value = 0:

Message A01711 was communicated from the first channel.

Value = 1 ... 999:

Number of the incorrect date in the data cross-check between the monitoring channels.

Value >= 1000:

Additional diagnostic values of the drive.

For index [1]:

Displays the value from the first channel that resulted in message A01711.

For index [2]:

Displays the value from the second channel that resulted in message A01711.

Index:

[0] = Message value for KDV

[1] = Channel 1 KDV actual value

[2] = Channel 2 KDV actual value

Dependency:

See also: A01711

Note

The significance of the individual message values is described in message A01711.

KDV: Data cross-check

For index [1, 2]:

When message A01711 is output with message value ≥ 1000 , then these indices are not supplied with values.

r9733[0...2]**SI Motion setpoint speed limit effective**

Data type: FloatingPoint32

Unit: [rpm]

Scaling: p2000

Description:

Displays the necessary setpoint speed limit as a result of the selected motion monitoring functions.

Contrary to the parameterization of the SI limit values, this parameter specifies the motor-side limit value and not the load-side limit value.

Index:

[0] = Setpoint limiting positive

[1] = Setpoint limiting negative

[2] = Setpoint limit absolute

Dependency:

For SLS: $r9733[0] = p9531[x] \times p9533$ (converted from the load side to the motor side)

For SDI negative: $r9733[0] = 0$

For SLS: $r9733[1] = -p9531[x] \times p9533$ (converted from the load side to the motor side)

For SDI positive: $r9733[1] = 0$

[x] = Selected SLS stage

Conversion factor from the motor side to the load side:

- motor type = rotary and axis type = linear: $p9522 / (p9521 \times p9520)$

- otherwise: $p9522 / p9521$

See also: p9531, p9533

Note

This parameter is not influenced by setting the axis type (p9502).

If the "SLS" or "SDI" function is not selected, r9733[0] shows p1082 and r9733[1] shows -p1082.

The display in r9733 can be delayed by up to one Safety monitoring clock cycle as compared to the display in r9719/r9720 and r9721/r9722.

When SOS is selected or an STO, SS1, SS2, SS2E, a setpoint of 0 is entered in r9733.

r9734.0...15**SI Safety Information Channel status word S_ZSW1B**

Data type: Unsigned16

Unit: -

Description:

Display for the status word of safety functions (S_ZSW1B).

Bit field:

Bit	Signal name	1 signal	0 signal
00	STO active	Yes	No
01	SS1 active	Yes	No
02	SS2 active	Yes	No
03	SOS active	Yes	No
04	SLS active	Yes	No
05	SOS selected	Yes	No
06	SLS selected	Yes	No
07	Internal event	Yes	No
08	SLA selected	Yes	No
09	Select SLS bit0	Yes	No
10	Select SLS bit1	Yes	No
12	SDI positive selected	Yes	No
13	SDI negative selected	Yes	No
15	Safety message present	Yes	No

14.2 List of parameters

Note

For bit 07:

An internal event is displayed if a fault response STO, SS1, SS2, SS2E, A01711 is active.

r9743.8...13**SI Safety Information Channel status word S_ZSW2B****Data type:** Unsigned16 **Unit:** -**Description:** Display for the status word of the safety functions (S_ZSW2B).

Bit field:	Bit	Signal name	1 signal	0 signal
	08	SDI positive selected	Yes	No
	09	SDI negative selected	Yes	No
	12	Test stop active	Yes	No
	13	Test stop required	Yes	No

r9765**SI Motion forced checking procedure remaining time****Data type:** FloatingPoint32 **Unit:** [h]**Description:** Displays the time remaining until the next dynamization and testing of the safety motion monitoring functions integrated in the drives.

The signal source to initiate the forced checking procedure is parameterized in p9705.

Dependency: See also: A01798**r9767.0...1****SI safety password status****Data type:** Unsigned32 **Unit:** -**Description:** Display and binector output for the status of the safety password.

Bit field:	Bit	Signal name	1 signal	0 signal
	00	Assign password	Yes	No
	01	Password entered	Yes	No

Note

For bit 00 = 1:

- a valid safety password was assigned.

For bit 01 = 1:

- a valid safety password was assigned (bit 0 = 1).

- safety parameters can be set.

r9768[0...7]**Receive SI PROFIsafe control words****Data type:** Unsigned16 **Unit:** -**Description:** Displays the received PROFIsafe telegram from the control.

Index:

- [0] = PZD 1
- [1] = PZD 2
- [2] = PZD 3
- [3] = PZD 4
- [4] = PZD 5
- [5] = PZD 6
- [6] = PZD 7
- [7] = PZD 8

Dependency: See also: r9769**Note**

The PROFIsafe trailer at the end of the telegram is also displayed (2 words).

r9769[0...7]	Send SI PROFIsafe status words
	Data type: Unsigned16 Unit: -
Description:	Displays the PROFIsafe telegram to be sent to the control.
Index:	[0] = PZD 1 [1] = PZD 2 [2] = PZD 3 [3] = PZD 4 [4] = PZD 5 [5] = PZD 6 [6] = PZD 7 [7] = PZD 8
Dependency:	See also: r9768
<hr/>	
Note	
The PROFIsafe trailer at the end of the telegram is also displayed (2 words).	

r9770[0...3]	SI version safety functions integrated in the drive
	Data type: Unsigned16 Unit: -
Description:	Displays the Safety Integrated version for the drive-integrated safety functions
Index:	[0] = Safety Version (major release) [1] = Safety Version (minor release) [2] = Safety Version (baselevel or patch) [3] = Safety Version (hotfix)
<hr/>	
Note	
Example: r9770[0] = 5, r9770[1] = 10, r9770[2] = 1, r9770[3] = 0 --> safety version V05.10.01.00	

r9776.0...3	SI diagnostics																				
	Data type: Unsigned32 Unit: -																				
Description:	Displays the operating state, referred to the safety functions.																				
Bit field:	<table border="0"> <thead> <tr> <th>Bit</th> <th>Signal name</th> <th>1 signal</th> <th>0 signal</th> </tr> </thead> <tbody> <tr> <td>00</td> <td>Safety parameter changed POWER ON required</td> <td>Yes</td> <td>No</td> </tr> <tr> <td>01</td> <td>Safety functions enabled</td> <td>Yes</td> <td>No</td> </tr> <tr> <td>02</td> <td>Safety component replaced and data save required</td> <td>Yes</td> <td>No</td> </tr> <tr> <td>03</td> <td>Safety component replaced and acknowledge/save required</td> <td>Yes</td> <td>No</td> </tr> </tbody> </table>	Bit	Signal name	1 signal	0 signal	00	Safety parameter changed POWER ON required	Yes	No	01	Safety functions enabled	Yes	No	02	Safety component replaced and data save required	Yes	No	03	Safety component replaced and acknowledge/save required	Yes	No
Bit	Signal name	1 signal	0 signal																		
00	Safety parameter changed POWER ON required	Yes	No																		
01	Safety functions enabled	Yes	No																		
02	Safety component replaced and data save required	Yes	No																		
03	Safety component replaced and acknowledge/save required	Yes	No																		
<hr/>																					
Note																					
For bit 00 = 1: At least one Safety parameter has been changed that will only take effect after a POWER ON.																					
For bit 01 = 1: Safety functions (basic functions or extended functions) have been enabled and are active.																					
For bit 02 = 1: A safety-relevant component has been replaced. Saving required (p0977 = 1).																					
For bit 03 = 1: A safety-relevant component has been replaced. Acknowledging (p9702 = 29) and saving (p0977 = 1) required.																					

r9781[0...1]	SI checksum to check changes
	Data type: Unsigned32 Unit: -
Description:	Displays the checksum to track changes for safety functions.
Index:	[0] = SI checksum to track functional changes [1] = SI checksum to track hardware-specific changes

14.2 List of parameters

Dependency: See also: p9601
See also: F01690

Note

The checksum changes when configuring safety functions.

r9782[0...1] SI change control time stamp

Data type: FloatingPoint32 **Unit:** [h]

Description: Displays the time stamps for the checksums for tracking changes for safety functions.
Each new checksum is assigned a time stamp (r9781).

Index: [0] = SI time stamp for checksum to track functional changes
[1] = SI time stamp for checksum to track hardware-specific changes

Dependency: See also: p9601
See also: F01690

r9790[0...1] SI Motion SLA acceleration resolution

Data type: FloatingPoint32 **Unit:** [m/s²]
Unit: [rev/s²]

Description: Displays the acceleration resolution (load side) for the "SLA" function.
Setpoints for acceleration limits or parameter changes for acceleration levels below this threshold have no effect.

Index: [0] = Coarse resolution
[1] = Fine resolution

Note

This parameter does not provide any information about the actual accuracy of the acceleration sensing. This depends on the type of actual value sensing, the gear factors as well as the quality of the encoder being used.

Conversion of:

(internal fixed value/ Tsi²) to m/s² (linear) or 1/s² (rotary) with Tsi = p9500 (SI motion monitoring clock cycle)

Example:

For Tsi = 12 ms, r9790[0] = 0.006944 m/s² (linear) or 0.019290 1/s² (rotary) is obtained.

For Tsi = 12 ms, r9790[1] = 0.000006944 m/s² (linear) or 0.000019290 1/s² (rotary) is obtained.

Internal calculation, which also incorporates the factor for the motor-load side conversion, the gearbox ratio and the safety monitoring clock cycle.

Result for a coarse resolution is 0.006944 m/s² (linear) - or 0.019290 1/s² (rotary).

Result for a fine resolution is 0.000006944 m/s² (linear) - or 0.000019290 1/s² (rotary).

The result listed above is applicable for the default setting of spindle pitch and gear unit stage.

SLA: Safely-Limited Acceleration

r9795 SI diagnostics F01611

Data type: Unsigned32 **Unit:** -

Description: Displays the number of the cross-checked data, which resulted in fault F01611.

Dependency: See also: F01611

Note

A complete list of numbers for cross-checked data items appears in fault F01611.

p10201 SI Motion SBT enable

Can be changed: C2(95) **Data type:** Unsigned32
Min: - **Max:** - **Def:** 0000 bin

Description: Sets the enable for the safe brake test.

Bit field:	Bit	Signal name	1 signal	0 signal
	00	Enable safe brake test	Yes	No

Note

SBT: Safe Brake Test

p10202[0...1]	SI Motion SBT brake Can be changed: C2(95) Data type: Integer16 Min: 0 Max: 1 Def: 0
Description:	Selecting the brake to be tested. p10202[0] must be set = 1 to test the brake.
Value:	0: Inhibit 1: Test motor holding brake
Index:	[0] = Brake 1 [1] = Reserved
Dependency:	See also: A01785
p10208[0...1]	SI Motion SBT test torque ramp time Can be changed: C2(95) Data type: FloatingPoint32 Min: 20 [ms] Max: 10000 [ms] Def: 1000 [ms]
Description:	Sets the time, during which the test torque is ramped up against the closed brake. The test torque is then ramped down after the safe brake test.
Index:	[0] = Brake 1 [1] = Reserved
	Note The set time is rounded internally to an integer multiple of the monitoring clock cycle.
p10209[0...1]	SI Motion SBT brake holding torque Can be changed: C2(95) Data type: FloatingPoint32 Min: 1.00 [Nm] Max: 60000.00 [Nm] Def: 10.00 [Nm]
Description:	Sets the effective holding torque on the motor side of the brake to be tested.
Index:	[0] = Brake 1 [1] = Reserved
Dependency:	See also: p10210, p10220
	Note The test torque effective for the brake test can be set for each sequence using a factor (p10210, p10220).
p10210[0...1]	SI Motion SBT test torque factor sequence 1 Can be changed: C2(95) Data type: FloatingPoint32 Min: 0.30 Max: 1.00 Def: 1.00
Description:	Sets the factor for the test torque of sequence 1 for the safe brake test. The factor is referred to the holding torque of the brake (p10209).
Index:	[0] = Brake 1 [1] = Reserved
Dependency:	See also: p10209
p10211[0...1]	SI Motion SBT test duration sequence 1 Can be changed: C2(95) Data type: FloatingPoint32 Min: 20 [ms] Max: 10000 [ms] Def: 1000 [ms]
Description:	Sets the test duration for sequence 1 for the safe brake test. The test torque is available for this time at the closed brake.

14.2 List of parameters

Index: [0] = Brake 1
[1] = Reserved

Note

The set time is rounded internally to an integer multiple of the monitoring clock cycle.

p10212[0...1] **SI Motion SBT position tolerance sequence 1**
Can be changed: C2(95) **Data type:** FloatingPoint32
Min: 0.001 [mm] **Max:** 360.000 [mm] **Def:** 1.000 [mm]
Min: 0.001 [°] **Max:** 360.000 [°] **Def:** 1.000 [°]
Description: Sets the tolerated position deviation for sequence 1 for the safe brake test.
Index: [0] = Brake 1
[1] = Reserved

p10220[0...1] **SI Motion SBT test torque factor sequence 2**
Can be changed: C2(95) **Data type:** FloatingPoint32
Min: 0.30 **Max:** 1.00 **Def:** 1.00
Description: Sets the factor for the test torque of sequence 2 for the safe brake test.
The factor is referred to the holding torque of the brake (p10209).
Index: [0] = Brake 1
[1] = Reserved
Dependency: See also: p10209

p10221[0...1] **SI Motion SBT test duration sequence 2**
Can be changed: C2(95) **Data type:** FloatingPoint32
Min: 20 [ms] **Max:** 10000 [ms] **Def:** 1000 [ms]
Description: Sets the test duration for sequence 2 for the safe brake test.
The test torque is available for this time at the closed brake.
Index: [0] = Brake 1
[1] = Reserved

Note

The set time is rounded internally to an integer multiple of the monitoring clock cycle.

p10222[0...1] **SI Motion SBT position tolerance sequence 2**
Can be changed: C2(95) **Data type:** FloatingPoint32
Min: 0.001 [mm] **Max:** 360.000 [mm] **Def:** 1.000 [mm]
Min: 0.001 [°] **Max:** 360.000 [°] **Def:** 1.000 [°]
Description: Sets the tolerated position deviation for sequence 2 for the safe brake test.
Index: [0] = Brake 1
[1] = Reserved

r10231 **SI Motion SBT control word diagnostics**
Data type: Unsigned32 **Unit:** -
Description: Displays the diagnostic bits for the control word of the safe brake test

Bit field:	Bit	Signal name	1 signal	0 signal
	00	Select brake test	Yes	No
	01	Start brake test	Yes	No
	03	Select test torque sign	Negative	Positive
	04	Select test sequence	Test sequence 2	Test sequence 1

r10234.0...15 SI Safety Information Channel status word S_ZSW3B**Data type:** Unsigned32 **Unit:** -**Description:** Display for the status word of the safety functions (S_ZSW3B).

Bit field:	Bit	Signal name	1 signal	0 signal
	00	Brake test selected	Yes	No
	01	Setpoint input drive/external	Drive	External
	03	Brake test active	Yes	No
	04	Brake test result	Successful	Erroneous/not
	05	Brake test completed	Yes	No
	07	Actual load sign	Negative	Positive
	11	SS2E active	Yes	No
	15	Acceptance test mode selected	Yes	No

Note

SS2E: Safe Stop 2 External (Safe Stop 2 with external stop)

For bits 05, 04:

For r10234.4 = 0 signal, it is possible to make a distinction as to whether the brake test was executed with error - or has still not been executed - using bit 5.

Bit 5/4 = 0/0: The brake test has still not been executed since the last warm restart or POWER ON.

Bit 5/4 = 1/0: The last brake test that was executed had an error.

r10240 SI Motion SBT test torque diagnostics**Data type:** FloatingPoint32 **Unit:** [Nm]**Description:** Displays the effective maximum test torque on the motor side for a safe brake test.**Dependency:** See also: p10210, p10220**Note**

The value remains displayed until the start of the next test sequence.

r10241 SI Motion SBT load torque diagnostics**Data type:** FloatingPoint32 **Unit:** [Nm]**Description:** Displays the load torque for a safe brake test.

When initializing the brake test, this load torque is available at the drive.

Note

The value remains displayed until the brake test is deselected.

r10242 SI Motion SBT state diagnostics**Data type:** Integer16 **Unit:** -**Description:** Displays the actual state of the safe brake test.

Value:	
0:	Brake test inactive, wait for SBT selection
1:	Setpoint input drive
2:	Determining the load
3:	Brake test is initialized, wait for start of test sequence
4:	Start test sequence
5:	Closing the brake, establishing the test torque
6:	Brake test active, wait for test duration sequence
7:	Reduce test torque
8:	Wait for the brake to open
9:	Brake test successfully completed, wait for start deselection
10:	Change to brake test initialized - fault acknowledgment
11:	Brake test canceled, torque is reduced

14.2 List of parameters

- 12: Brake test canceled, wait for brake to open
- 13: Brake test ended with error, wait for acknowledgment
- 14: Brake opening timer elapsed
- 15: Error when initializing the brake test, wait for acknowledgment
- 16: Change to brake test inactive, acknowledgment active

r10251.8...12 SI Safety Control Channel control word S_STW1B diagnostics

Data type: Unsigned32 **Unit:** -

Description: Displays the diagnostics of control word S_STW1 of the Safety Control Channel.

Bit field:	Bit	Signal name	1 signal	0 signal
	08	Extended Functions test stop selection	Selected	Not selected
	12	Extended Functions, premature SOS after SS2E	Selected	Not selected

Note
SCC: Safety Control Channel

p60000 PROFdrive reference speed

Can be changed: T **Data type:** FloatingPoint32
Min: 6.00 [rpm] **Max:** 210000.00 [rpm] **Def:** 3000.00 [rpm]

Description: Sets the reference quantity for the speed values.
All speeds specified as relative values refer to this reference quantity.
The reference quantity corresponds to 100% or 4000 hex (word) or 4000 0000 hex (double word).

Dependency: See also: p2000

Note
Parameter p60000 is an image of parameter p2000 in conformance with PROFdrive.
A change always effects both parameters.

r60022 PROFIsafe telegram selection

Data type: Unsigned16 **Unit:** -

Description: Displays the number of the PROFIsafe send and receive telegrams.
The telegram settings are taken from the higher-level control system.

Value:
0: No PROFIsafe telegram selected
30: PROFIsafe standard telegram 30, PZD-1/1
901: PROFIsafe SIEMENS telegram 901, PZD-3/5

Dependency: See also: p9611

r60100[0...4] PROFdrive telegram display total

Data type: Unsigned16 **Unit:** -

Description: Displays the send and receive telegrams.

Index:
[0] = Subslot 1: MAP
[1] = Subslot 2: PROFIsafe
[2] = Subslot 3: standard/SIEMENS
[3] = Subslot 4: supplementary telegram
[4] = Subslot 5: supplementary telegram

Dependency: See also: r0922, r60022, r60122

Note
Value = 65564: no telegram active
Value = 65565: MAP "Module Access Point"

r60122 **PROFIdrive SIC/SCC telegram selection**
Data type: Unsigned16 **Unit:** -

Description: Displays the telegram for the Safety Information Channel (SIC) / Safety Control Channel (SCC).
The telegram settings are taken from the higher-level control system.

Value: 700: Supplementary telegram 700, PZD-0/3
701: Supplementary telegram 701, PZD-2/5
999: No telegram

r61000[0...239] **PROFINET Name of Station**
Data type: Unsigned8 **Unit:** -

Description: Displays PROFINET Name of Station.

r61001[0...3] **PROFINET IP of Station**
Data type: Unsigned8 **Unit:** -

Description: Displays PROFINET IP of Station.

Faults and alarms

15.1 Overview of faults and alarms

Explanations for the list of faults and alarms

A message comprises a letter followed by the relevant number.

The letters have the following meaning:

- A means "Alarm"
- F means "Fault"
- N means "No message" or "Internal message"

Detailed examples:

Axxxxx	Alarm xxxxx
Fxxxxx	Fault xxxxx
Nxxxxx	No message

Fault responses

Note

OFF1, OFF2 and OFF3 fault responses

The fault responses have the following consequence:

- OFF1: Standard motor shutdown, factory setting ramp-down time 1 s. Can be changed using p1121
 - OFF2: The motor current is immediately switched off - which means that the motor no longer generates a torque.
 - OFF3: Fast stop, the motor is braked down to standstill as quickly as possible. Factory setting, ramp down time 0 s, can be changed using p1135
-

Acknowledging faults

For each fault, the list of faults and alarms specifies how the fault is acknowledged after resolving the cause of the fault.

15.1 Overview of faults and alarms

You must first remove the cause before you can resolve a fault. If the cause has still not been resolved then the fault is immediately displayed again after running up.

- POWER ON: Acknowledge by switching off the converter and switching on again
- IMMEDIATELY: Acknowledge via STW1.7 (0 -> 1) - or switch off the converter and switch on again.
- PULSE INHIBIT: Acknowledge only possible in the "Pulse inhibit" state (r0899.11 = 0). Acknowledge via STW1.7 (0 -> 1) - or switch off the converter and switch on again.

15.2 List of faults and alarms

Product: SINAMICS S210, Version: 5202300, Language: eng
Objects: S210

F01000 Internal software error

Reaction: OFF2

Acknowledge: POWER ON

Cause: An internal software error has occurred.
Fault value (r0949, interpret hexadecimal):
Only for internal Siemens troubleshooting.

Remedy:

- evaluate fault buffer (r0945).
- carry out a POWER ON (switch-off/switch-on) for all components.
- if required, check the data on the non-volatile memory (e.g. memory card).
- upgrade firmware to later version.
- contact Technical Support.
- replace the Control Unit.

F01001 FloatingPoint exception

Reaction: OFF2

Acknowledge: POWER ON

Cause: An exception occurred during an operation with the FloatingPoint data type.
The error may be caused by the basic system or a technology function (e.g. FBLOCKS, DCC, TEC).
Fault value (r0949, interpret hexadecimal):
Only for internal Siemens troubleshooting.

Note:

Refer to r9999 for further information about this fault.

r9999[0]: Fault number.

r9999[1]: Program counter at the time when the exception occurred.

r9999[2]: Cause of the FloatingPoint exception.

Bit 0 = 1: Operation invalid

Bit 1 = 1: Division by zero

Bit 2 = 1: Overflow

Bit 3 = 1: Underflow

Bit 4 = 1: Inaccurate result

Remedy:

- carry out a POWER ON (switch-off/switch-on) for all components.
- check configuration and signals of the blocks in FBLOCKS.
- check configuration and signals of DCC charts.
- check configuration and signals of TEC charts.
- upgrade firmware to later version.
- contact Technical Support.

F01002 Internal software error

Reaction: OFF2

Acknowledge: IMMEDIATELY

Cause: An internal software error has occurred.
Fault value (r0949, interpret hexadecimal):
Only for internal Siemens troubleshooting.

15.2 List of faults and alarms

Remedy:

- carry out a POWER ON (switch-off/switch-on) for all components.
- upgrade firmware to later version.
- contact Technical Support.

F01003 Acknowledgment delay when accessing the memory

Reaction: OFF2

Acknowledge: IMMEDIATELY

Cause: A memory area was accessed that does not return a "READY".
Fault value (r0949, interpret hexadecimal):
Only for internal Siemens troubleshooting.

Remedy:

- carry out a POWER ON (switch-off/switch-on) for all components.
- contact Technical Support.

N01004 Internal software error

Reaction: NONE

Acknowledge: NONE

Cause: An internal software error has occurred.
Fault value (r0949, hexadecimal):
Only for internal Siemens troubleshooting.

Remedy:

- read out diagnostics parameter (r9999).
- contact Technical Support.

F01005 Firmware download for DRIVE-CLiQ component unsuccessful

Reaction: NONE

Acknowledge: IMMEDIATELY

Cause:	<p>It was not possible to download the firmware to a DRIVE-CLiQ component. Fault value (r0949, interpret hexadecimal): yyxxxx hex: yy = component number, xxxx = fault cause xxxx = 000B hex = 11 dec: DRIVE-CLiQ component has detected a checksum error. xxxx = 000F hex = 15 dec: The selected DRIVE-CLiQ component did not accept the contents of the firmware file. xxxx = 0012 hex = 18 dec: Firmware version is too old and is not accepted by the component. xxxx = 0013 hex = 19 dec: Firmware version is not suitable for the hardware release of the component. xxxx = 0065 hex = 101 dec: After several communication attempts, no response from the DRIVE-CLiQ component. xxxx = 008B hex = 139 dec: Initially, a new boot loader is loaded (must be repeated after POWER ON). xxxx = 008C hex = 140 dec: Firmware file for the DRIVE-CLiQ component not available on the memory card. xxxx = 008D hex = 141 dec: An inconsistent length of the firmware file was signaled. The firmware download may have been caused by a loss of connection to the firmware file. This can occur during a project download/reset in the case of a SINAMICS Integrated Control Unit, for example. xxxx = 008F hex = 143 dec: Component has not changed to the mode for firmware download. It was not possible to delete the existing firmware. xxxx = 0090 hex = 144 dec: When checking the firmware that was downloaded (checksum), the component detected a fault. It is possible that the file on the memory card is defective. xxxx = 0091 hex = 145 dec: Checking the loaded firmware (checksum) was not completed by the component in the appropriate time. xxxx = 009C hex = 156 dec: Component with the specified component number is not available (p7828). xxxx = Additional values: Only for internal Siemens troubleshooting.</p>
Remedy:	<ul style="list-style-type: none"> - check the selected component number (p7828). - check the DRIVE-CLiQ wiring. - save suitable firmware file for download in the directory "/siemens/sinamics/code/sac/". - use a component with a suitable hardware version - after POWER ON has been carried out again for the DRIVE-CLiQ component, download firmware again. Depending on p7826, the firmware will be automatically downloaded.

A01006 Firmware update for DRIVE-CLiQ component required

Reaction: NONE

Acknowledge: NONE

Cause: The firmware of a DRIVE-CLiQ component must be updated as there is no suitable firmware or firmware version in the component for operation with the Control Unit.

Alarm value (r2124, interpret decimal):
 Component number of the DRIVE-CLiQ component.

Remedy: Update the firmware using the commissioning tool:
 The firmware version of all of the components on the "Version overview" page can be read in the Project Navigator under "Configuration" of the associated drive unit and an appropriate firmware update can be carried out.

Firmware update via parameter:
 - take the component number from the alarm value and enter into p7828.
 - start the firmware download with p7829 = 1.

A01007 **POWER ON for DRIVE-CLiQ component required**

Reaction: NONE

Acknowledge: NONE

Cause: A DRIVE-CLiQ component must be switched on again (POWER ON) (e.g. due to a firmware update).
Alarm value (r2124, interpret decimal):
Component number of the DRIVE-CLiQ component.
Note:
For a component number = 1, a POWER ON of the Control Unit is required.

Remedy: - Switch off the power supply of the specified DRIVE-CLiQ component and switch it on again.
- For SINUMERIK, auto commissioning is prevented. In this case, a POWER ON is required for all components and the auto commissioning must be restarted.

A01009 **CU: Control module overtemperature**

Reaction: NONE

Acknowledge: NONE

Cause: The temperature (r0037[0]) of the control module (Control Unit) has exceeded the specified limit value.

Remedy: - check the air intake for the Control Unit.
- check the Control Unit fan.
Note:
The alarm is automatically withdrawn once the limit value has been fallen below.

F01011 **Download interrupted**

Reaction: NONE

Acknowledge: IMMEDIATELY

Cause: The project download was interrupted.
Fault value (r0949, interpret decimal):
1: The user prematurely interrupted the project download.
2: The communication cable was interrupted (e.g. cable breakage, cable withdrawn).
3: The project download was prematurely exited by the commissioning tool.
100: Different versions between the firmware version and project files which were loaded by loading into the file system "Download from memory card".
Note:
The response to an interrupted download is the state "first commissioning".

Remedy: - check the communication cable.
- download the project again.
- boot from previously saved files (switch-off/switch-on or p0976).
- when loading into the file system (download from memory card), use the matching version.

F01012 **Project conversion error**

Reaction: OFF2

Acknowledge: IMMEDIATELY

Cause: When converting the project of an older firmware version, an error occurred.
Fault value (r0949, interpret decimal):
Parameter number of the parameter causing the error.
For fault value = 600, the following applies:
The temperature evaluation is no longer assigned to the power unit but to the encoder evaluation.
Notice:
Monitoring of the motor temperature is no longer ensured.

Remedy: Check the parameter indicated in the fault value and correctly adjust it accordingly.
 For fault value = 600:
 Parameter p0600 must be set to the values 1, 2 or 3 in accordance with the assignment of the internal encoder evaluation to the encoder interface.
 Value 1 means: The internal encoder evaluation is assigned to the encoder interface 1 via p0187.
 Value 2 means: The internal encoder evaluation is assigned to the encoder interface 2 via p0188.
 Value 3 means: The internal encoder evaluation is assigned to the encoder interface 3 via p0189.
 - if necessary, the internal encoder evaluation must be assigned to an encoder interface via parameters p0187, p0188 or p0189 accordingly.
 - if necessary, upgrade the firmware to a later version.

F01015 Internal software error

Reaction: OFF2

Acknowledge: POWER ON

Cause: An internal software error has occurred.

Fault value (r0949, interpret decimal):

Only for internal Siemens troubleshooting.

Remedy: - carry out a POWER ON (switch-off/switch-on) for all components.
 - upgrade firmware to later version.
 - contact Technical Support.

A01016 Firmware changed

Reaction: NONE

Acknowledge: NONE

Cause: At least one firmware file in the directory was illegally changed on the non-volatile memory (memory card/device memory) with respect to the version when shipped from the factory.

Alarm value (r2124, interpret decimal):

0: Checksum of one file is incorrect.

1: File missing.

2: File too many.

3: Incorrect firmware version.

4: Incorrect checksum of the back-up file.

Remedy: For the non-volatile memory for the firmware (memory card/device memory), restore the delivery condition.

Note:

The file involved can be read out using parameter r9925.

The status of the firmware check is displayed using r9926.

F01018 Booting has been interrupted several times

Reaction: NONE

Acknowledge: POWER ON

Cause: Module booting was interrupted several times. As a consequence, the module boots with the factory setting.

Possible reasons for booting being interrupted:

- power supply interrupted.

- CPU crashed.

- parameterization invalid.

15.2 List of faults and alarms

Remedy:

- carry out a POWER ON (switch-off/switch-on). After switching on, the module reboots from the valid parameterization (if available).
- restore the valid parameterization.

Examples:

- a) Carry out a first commissioning, save, carry out a POWER ON (switch-off/switch-on).
- b) Load another valid parameter backup (e.g. from the memory card), save, carry out a POWER ON (switch-off/switch-on).

Note:

If the fault situation is repeated, then this fault is again output after several interrupted boots.

A01019 Writing to the removable data medium unsuccessful

Reaction: NONE
Acknowledge: NONE
Cause: The write access to the removable data medium was unsuccessful.
Remedy: Remove and check the removable data medium. Then run the data backup again.

A01020 Writing to RAM disk unsuccessful

Reaction: NONE
Acknowledge: NONE
Cause: A write access to the internal RAM disk was unsuccessful.
Remedy: Adapt the file size for the system logbook to the internal RAM disk (p9930).

F01023 Software timeout (internal)

Reaction: NONE
Acknowledge: IMMEDIATELY
Cause: An internal software timeout has occurred.
Fault value (r0949, interpret decimal):
Only for internal Siemens troubleshooting.
Remedy:

- carry out a POWER ON (switch-off/switch-on) for all components.
- upgrade firmware to later version.
- contact Technical Support.

F01030 Sign-of-life failure for master control

Reaction: OFF3
Acknowledge: IMMEDIATELY
Cause: For active PC master control, no sign-of-life was received within the monitoring time.
The master control was returned to the active BICO interconnection.
Remedy: Set the monitoring time higher at the PC or, if required, completely disable the monitoring function.
The monitoring time is set as follows using the commissioning tool:
<Drive> -> Commissioning -> Control panel -> Button "Fetch master control" -> A window is displayed to set the monitoring time in milliseconds.
Notice:
The monitoring time should be set as short as possible. A long monitoring time means a late response when the communication fails!

F01031 Sign-of-life failure for OFF in REMOTE

Reaction: OFF3
Acknowledge: IMMEDIATELY
Cause: With the "OFF in REMOTE" mode active, no sign-of-life was received within 3 seconds.
Remedy:

- check the data cable connection at the serial interface for the Control Unit (CU) and operator panel.
- check the data cable between the Control Unit and operator panel.

F01033 Units changeover: Reference parameter value invalid
Reaction: NONE
Acknowledge: IMMEDIATELY
Cause: When changing over the units to the referred representation type, it is not permissible for any of the required reference parameters to be equal to 0.0
 Fault value (r0949, parameter):
 Reference parameter whose value is 0.0.
Remedy: Set the value of the reference parameter to a number different than 0.0.
 See also: r0304 (Rated motor voltage), r0305 (Rated motor current), p2000 (Reference speed), p2003 (Reference torque)

F01034 Units changeover: Calculation parameter values after reference value change unsuccessful
Reaction: NONE
Acknowledge: IMMEDIATELY
Cause: The change of a reference parameter meant that for an involved parameter the selected value was not able to be re-calculated in the per unit representation. The change was rejected and the original parameter value restored.
 Fault value (r0949, parameter):
 Parameter whose value was not able to be re-calculated.
 See also: r0304 (Rated motor voltage), r0305 (Rated motor current), p2000 (Reference speed), p2003 (Reference torque)
Remedy: - Select the value of the reference parameter such that the parameter involved can be calculated in the per unit representation.
 - technology unit selection (p0595) before changing the reference parameter p0596, set p0595 = 1.

A01035 ACX: Parameter back-up file corrupted
Reaction: NONE
Acknowledge: NONE
Cause: When the Control Unit is booted, no complete data set was found from the parameter back-up files. The last time that the parameterization was saved, it was not completely carried out.
 It is possible that the backup was interrupted by switching off or withdrawing the memory card.
 Alarm value (r2124, interpret hexadecimal):
 ddccbbaa hex:
 aa = 01 hex:
 Power up was realized without data backup. The drive is in the factory setting.
 aa = 02 hex:
 The last available backup data record was loaded. The parameterization must be checked. It is recommended that the parameterization is downloaded again.
 dd, cc, bb:
 Only for internal Siemens troubleshooting.
 See also: p0977 (Save all parameters)
Remedy: - download the project again using the commissioning tool.
 - save all parameters (p0977 = 1 or "copy RAM to ROM").
 See also: p0977 (Save all parameters)

F01036 ACX: Parameter back-up file missing
Reaction: NONE
Acknowledge: IMMEDIATELY

15.2 List of faults and alarms

Cause: When downloading the device parameterization, a parameter back-up file PSxxxxxy.ACX associated with a drive object cannot be found.
Fault value (r0949, interpret hexadecimal):
Byte 1: yyy in the file name PSxxxxxy.ACX
yyy = 000 --> consistency back-up file
yyy = 001 ... 062 --> drive object number
yyy = 099 --> PROFIBUS parameter back-up file
Byte 2, 3, 4:
Only for internal Siemens troubleshooting.

Remedy: If you have saved your project data using the commissioning tool, carry-out a new download for your project.
Save using the function "Copy RAM to ROM" or with p0977 = 1.
This means that the parameter files are again completely written into the non-volatile memory.
Note:
If the project data have not been backed up, then a new first commissioning is required.

F01039 ACX: Writing to the parameter back-up file was unsuccessful

Reaction: NONE

Acknowledge: IMMEDIATELY

Cause: Writing to at least one parameter back-up file PSxxxxxy.*** in the non-volatile memory was unsuccessful.
- in the directory /USER/SINAMICS/DATA/ at least one parameter back-up file PSxxxxxy.*** has the "read only" file attribute and cannot be overwritten.
- there is not sufficient free memory space available.
- the non-volatile memory is defective and cannot be written to.
Fault value (r0949, interpret hexadecimal):
dcb hex
a = yyy in the file names PSxxxxxy.***
a = 000 --> consistency back-up file
a = 001 ... 062 --> drive object number
a = 070 --> FEPROM.BIN
a = 080 --> DEL4BOOT.TXT
a = 099 --> PROFIBUS parameter back-up file
b = xxx in the file names PSxxxxxy.***
b = 000 --> data save started with p0977 = 1 or p0971 = 1
b = 010 --> data save started with p0977 = 10
b = 011 --> data save started with p0977 = 11
b = 012 --> data save started with p0977 = 12
d, c:
Only for internal Siemens troubleshooting.

Remedy: - check the file attribute of the files (PSxxxxxy.***, CAxxxxxy.***, CCxxxxxy.***) and, if required, change from "read only" to "writeable".
- check the free memory space in the non-volatile memory. Approx. 80 kbyte of free memory space is required for every drive object in the system.
- replace the memory card or Control Unit.

F01040 Save parameter settings and carry out a POWER ON

Reaction: OFF2

Acknowledge: POWER ON

Cause: A parameter was changed, which means that it is necessary to save the parameters and reboot.

Remedy: - save parameters (p0977).
- carry out a POWER ON (switch-off/switch-on).
Then:
- upload the data to the converter (commissioning tool).

F01041 Parameter save necessary

Reaction: NONE

Acknowledge: IMMEDIATELY

Cause: Defective or missing files were detected on the memory card when booting.

Fault value (r0949, interpret decimal):

- 1: Source file cannot be opened.
- 2: Source file cannot be read.
- 3: Target directory cannot be set up.
- 4: Target file cannot be set up/opened.
- 5: Target file cannot be written to.

Additional values:

Only for internal Siemens troubleshooting.

- Remedy:**
- save the parameters.
 - download the project again to the drive unit.
 - update the firmware
 - if required, replace the Control Unit and/or memory card card.

F01042 Parameter error during project download

Reaction: OFF2

Acknowledge: IMMEDIATELY

15.2 List of faults and alarms

- Cause:** An error was detected when downloading a project using the commissioning software (e.g. incorrect parameter value). It is possible that the parameter limits are dependent on other parameters.
The detailed cause of the fault can be determined using the fault value.
Fault value (r0949, interpret hexadecimal):
ccbbaaaa hex
aaaa = Parameter
bb = Index
cc = fault cause
- 0: Parameter number illegal.
 - 1: Parameter value cannot be changed.
 - 2: Lower or upper value limit exceeded.
 - 3: Sub-index incorrect.
 - 4: No array, no sub-index.
 - 5: Data type incorrect.
 - 6: Setting not permitted (only resetting).
 - 7: Descriptive element cannot be changed.
 - 9: Descriptive data not available.
 - 11: No master control.
 - 15: No text array available.
 - 17: Task cannot be executed due to operating state.
 - 20: Illegal value.
 - 21: Response too long.
 - 22: Parameter address illegal.
 - 23: Format illegal.
 - 24: Number of values not consistent.
 - 25: Drive object does not exist.
 - 101: Presently deactivated.
 - 104: Illegal value.
 - 107: Write access not permitted when controller enabled.
 - 108: Unit unknown.
 - 109: Write access only in the commissioning state, encoder (p0010 = 4).
 - 110: Write access only in the commissioning state, motor (p0010 = 3).
 - 111: Write access only in the commissioning state, power unit (p0010 = 2).
 - 112: Write access only in the quick commissioning mode (p0010 = 1).
 - 113: Write access only in the ready mode (p0010 = 0).
 - 114: Write access only in the commissioning state, parameter reset (p0010 = 30).
 - 115: Write access only in the Safety Integrated commissioning state (p0010 = 95).
 - 116: Write access only in the commissioning state, technological application/units (p0010 = 5).
 - 117: Write access only in the commissioning state (p0010 not equal to 0).
 - 118: Write access only in the commissioning state, download (p0010 = 29).
 - 119: Parameter may not be written in download.
 - 120: Write access only in the commissioning state, drive basic configuration (device: p0009 = 3).
 - 121: Write access only in the commissioning state, define drive type (device: p0009 = 2).
 - 122: Write access only in the commissioning state, data set basic configuration (device: p0009 = 4).
 - 123: Write access only in the commissioning state, device configuration (device: p0009 = 1).
 - 124: Write access only in the commissioning state, device download (device: p0009 = 29).
 - 125: Write access only in the commissioning state, device parameter reset (device: p0009 = 30).
 - 126: Write access only in the commissioning state, device ready (device: p0009 = 0).
 - 127: Write access only in the commissioning state, device (device: p0009 not equal to 0).
 - 129: Parameter may not be written in download.
 - 130: Transfer of the master control is inhibited via binector input p0806.
 - 131: Required BICO interconnection not possible because BICO output does not supply floating value

- 132: Free BICO interconnection inhibited via p0922.
- 133: Access method not defined.
- 200: Below the valid values.
- 201: Above the valid values.
- 202: Cannot be accessed from the Basic Operator Panel (BOP).
- 203: Cannot be read from the Basic Operator Panel (BOP).
- 204: Write access not permitted.

Remedy:

- correct the parameterization in the commissioning tool and download the project again.
- enter the correct value in the specified parameter.
- identify the parameter that restricts the limits of the specified parameter.

F01043 Fatal error at project download

Reaction: NONE

Acknowledge: IMMEDIATELY

Cause: A fatal error was detected when downloading a project using the commissioning tool.

Fault value (r0949, interpret decimal):

- 1: Device status cannot be changed to Device Download (drive object ON?).
- 2: Incorrect drive object number.
- 3: A drive object that has already been deleted is deleted again.
- 4: Deleting of a drive object that has already been registered for generation.
- 5: Deleting a drive object that does not exist.
- 6: Generating an undeleted drive object that already existed.
- 7: Regenerating a drive object already registered for generation.
- 8: Maximum number of drive objects that can be generated exceeded.
- 9: Error while generating a device drive object.
- 10: Error while generating target topology parameters (p9902 and p9903).
- 11: Error while generating a drive object (global component).
- 12: Error while generating a drive object (drive component).
- 13: Unknown drive object type.
- 14: Drive status cannot be changed to "ready for operation" (r0947 and r0949).
- 15: Drive status cannot be changed to drive download.
- 16: Device status cannot be changed to "ready for operation".
- 17: It is not possible to download the topology. The component wiring should be checked, taking into account the various messages/signals.
- 18: A new download is only possible if the factory settings are restored for the drive unit.
- 19: The slot for the option module has been configured several times (e.g. CAN and COMM BOARD)
- 20: The configuration is inconsistent (e.g. CAN for Control Unit, however no CAN configured for drive objects A_INF, SERVO or VECTOR).
- 21: Error when accepting the download parameters.
- 22: Software-internal download error.
- 23: download not possible when know-how protection is activated.
- 24: download not possible during a partial power up after inserting a component.
- 25: The configuration is inconsistent. Know-how protection is either not activated or only partially.

Additional values:

Only for internal Siemens troubleshooting.

15.2 List of faults and alarms

- Remedy:**
- use the current version of the commissioning tool.
 - modify the offline project and carry out a new download (e.g. compare the number of drive objects, motor, encoder, power unit in the offline project and at the drive).
 - change the drive state (is a drive rotating or is there a message/signal?).
 - carefully note any other active messages/signals and remove their cause (e.g. correct any incorrectly set parameters).
 - automatically calculate the control parameters (p0340). Then set p0010 = 0.
 - boot from previously saved files (switch-off/switch-on or p0976).
 - before a new download, restore the factory setting if the know-how protection was not activated on all drive objects.

F01044 CU: Descriptive data error

Reaction: OFF2

Acknowledge: POWER ON

Cause: An error was detected when loading the descriptive data saved in the non-volatile memory.

Remedy: Replace the memory card or Control Unit.

A01045 CU: Configuring data invalid

Reaction: NONE

Acknowledge: NONE

Cause: An error was detected when evaluating the parameter files PSxxxxxyy.ACX, PTxxxxyy.ACX, CAxxxxyy.ACX, or CCxxxxyy.ACX saved in the non-volatile memory. Because of this, under certain circumstances, several of the saved parameter values were not able to be accepted.

Alarm value (r2124, interpret hexadecimal):
Only for internal Siemens troubleshooting.

Remedy: - Restore the factory setting using (p0976 = 1) and re-load the project into the drive unit.
Then save the parameterization using the "Copy RAM to ROM" or with p0977 = 1. This overwrites the incorrect parameter files in the non-volatile memory – and the alarm is withdrawn.

A01049 CU: It is not possible to write to file

Reaction: NONE

Acknowledge: NONE

Cause: It is not possible to write into a write-protected file (PSxxxxxx.acx). The write request was interrupted.
Alarm value (r2124, interpret decimal):
Drive object number.

Remedy: Check whether the "write protected" attribute has been set for the files in the non-volatile memory under .../USER/SINAMICS/DATA/...
When required, remove write protection and save again (e.g. set p0977 to 1).

F01050 Memory card and device incompatible

Reaction: OFF2

Acknowledge: IMMEDIATELY

Cause: The memory card and the device type do not match (e.g. a memory card for SINAMICS S is inserted in SINAMICS G).

Remedy: - insert the matching memory card.
- use the matching Control Unit or power unit.

A01064 CU: Internal error (CRC)

Reaction: NONE

Acknowledge: NONE

Cause: A checksum error (CRC error) has occurred in the Control Unit program memory

Remedy:

- carry out a POWER ON (switch-off/switch-on) for all components.
- upgrade firmware to later version.
- contact Technical Support.

A01069 Parameter backup and device incompatible

Reaction: NONE

Acknowledge: NONE

Cause: The parameter backup on the memory card and the drive unit do not match.
The module boots with the factory settings.

Example:

Devices A and B. are not compatible and a memory card with the parameter backup for device A is inserted in device B.

Remedy:

- insert a memory card with compatible parameter backup and carry out a POWER ON.
- insert a memory card without parameter backup and carry out a POWER ON.
- save the parameters (p0977 = 1).

F01072 Memory card restored from the backup copy

Reaction: NONE

Acknowledge: IMMEDIATELY

Cause: The Control Unit was switched-off while writing to the memory card. This is why the visible partition became defective.
After switching on, the data from the non-visible partition (backup copy) were written to the visible partition.

Remedy: Check that the firmware and parameterization is up-to-date.

A01073 POWER ON required for backup copy on memory card

Reaction: NONE

Acknowledge: NONE

Cause: The parameter assignment on the visible partition of the memory card has changed.
In order that the backup copy on the memory card is updated on the non-visible partition, it is necessary to carry out a POWER ON or hardware reset (p0972) of the Control Unit.

Note:

It is possible that a new POWER ON is requested via this alarm (e.g. after saving with p0971 = 1).

Remedy:

- carry out a POWER ON (switch-off/switch-on) for the Control Unit.
- carry out a hardware reset (RESET button, p0972).

F01082 Parameter error when powering up from data backup

Reaction: OFF2

Acknowledge: IMMEDIATELY

15.2 List of faults and alarms

- Cause:** Parameterizing errors have been detected (e.g. incorrect parameter value). It is possible that the parameter limits are dependent on other parameters.
The detailed cause of the fault can be determined using the fault value.
Fault value (r0949, interpret hexadecimal):
ccbbaaaa hex
aaaa = Parameter
bb = Index
cc = fault cause
- 0: Parameter number illegal.
 - 1: Parameter value cannot be changed.
 - 2: Lower or upper value limit exceeded.
 - 3: Sub-index incorrect.
 - 4: No array, no sub-index.
 - 5: Data type incorrect.
 - 6: Setting not permitted (only resetting).
 - 7: Descriptive element cannot be changed.
 - 9: Descriptive data not available.
 - 11: No master control.
 - 15: No text array available.
 - 17: Task cannot be executed due to operating state.
 - 20: Illegal value.
 - 21: Response too long.
 - 22: Parameter address illegal.
 - 23: Format illegal.
 - 24: Number of values not consistent.
 - 25: Drive object does not exist.
 - 101: Presently deactivated.
 - 104: Illegal value.
 - 107: Write access not permitted when controller enabled.
 - 108: Unit unknown.
 - 109: Write access only in the commissioning state, encoder (p0010 = 4).
 - 110: Write access only in the commissioning state, motor (p0010 = 3).
 - 111: Write access only in the commissioning state, power unit (p0010 = 2).
 - 112: Write access only in the quick commissioning mode (p0010 = 1).
 - 113: Write access only in the ready mode (p0010 = 0).
 - 114: Write access only in the commissioning state, parameter reset (p0010 = 30).
 - 115: Write access only in the Safety Integrated commissioning state (p0010 = 95).
 - 116: Write access only in the commissioning state, technological application/units (p0010 = 5).
 - 117: Write access only in the commissioning state (p0010 not equal to 0).
 - 118: Write access only in the commissioning state, download (p0010 = 29).
 - 119: Parameter may not be written in download.
 - 120: Write access only in the commissioning state, drive basic configuration (device: p0009 = 3).
 - 121: Write access only in the commissioning state, define drive type (device: p0009 = 2).
 - 122: Write access only in the commissioning state, data set basic configuration (device: p0009 = 4).
 - 123: Write access only in the commissioning state, device configuration (device: p0009 = 1).
 - 124: Write access only in the commissioning state, device download (device: p0009 = 29).
 - 125: Write access only in the commissioning state, device parameter reset (device: p0009 = 30).
 - 126: Write access only in the commissioning state, device ready (device: p0009 = 0).
 - 127: Write access only in the commissioning state, device (device: p0009 not equal to 0).
 - 129: Parameter may not be written in download.
 - 130: Transfer of the master control is inhibited via binector input p0806.
 - 131: Required BICO interconnection not possible because BICO output does not supply floating value

- 132: Free BICO interconnection inhibited via p0922.
- 133: Access method not defined.
- 200: Below the valid values.
- 201: Above the valid values.
- 202: Cannot be accessed from the Basic Operator Panel (BOP).
- 203: Cannot be read from the Basic Operator Panel (BOP).
- 204: Write access not permitted.

Remedy:

- correct the parameterization in the commissioning tool and download the project again.
- enter the correct value in the specified parameter.
- identify the parameter that restricts the limits of the specified parameter.

A01099 UTC synchronization tolerance violated

Reaction: NONE

Acknowledge: NONE

Cause: The tolerance (p3109) set for UTC synchronization was violated.

Note:

UTC: Universal Time Coordinates

Remedy: Select the synchronization intervals shorter so that the deviation between the time of day master and drive system lies within the tolerance.

Note:

The deviation when synchronizing is shown in r3107.

F01120 Terminal initialization has failed

Reaction: OFF1

Acknowledge: IMMEDIATELY

Cause: An internal software error occurred while the terminal functions were being initialized.

Fault value (r0949, interpret hexadecimal):

Only for internal Siemens troubleshooting.

Remedy:

- carry out a POWER ON (switch-off/switch-on) for all components.
- upgrade firmware to later version.
- contact Technical Support.
- replace the Control Unit.

F01122 Frequency at the measuring probe input too high

Reaction: OFF1

Acknowledge: IMMEDIATELY

Cause: The frequency of the pulses at the measuring probe input is too high.

Fault value (r0949, interpret decimal):

1: DI/DO 9 (X122.8)

2: DI/DO 10 (X122.10)

4: DI/DO 11 (X122.11)

8: DI/DO 13 (X132.8)

16: DI/DO 14 (X132.10)

32: DI/DO 15 (X132.11)

64: DI/DO 8 (X122.7)

128: DI/DO 12 (X132.7)

Remedy: Reduce the frequency of the pulses at the measuring probe input.

F01250 CU: CU-EEPROM incorrect read-only data

Reaction: NONE

15.2 List of faults and alarms

Acknowledge: POWER ON
Cause: Error when reading the read-only data of the EEPROM in the Control Unit.
Fault value (r0949, interpret decimal):
Only for internal Siemens troubleshooting.
Remedy: - carry out a POWER ON (switch-off/switch-on).
- replace the Control Unit.

A01251 **CU: CU-EEPROM incorrect read-write data**
Reaction: NONE
Acknowledge: NONE
Cause: Error when reading the read-write data of the EEPROM in the Control Unit.
Alarm value (r2124, interpret decimal):
Only for internal Siemens troubleshooting.
Remedy: For alarm value r2124 < 256, the following applies:
- carry out a POWER ON (switch-off/switch-on).
- replace the Control Unit.
For alarm value r2124 >= 256, the following applies:
- for the drive object with this alarm, clear the fault memory (p0952 = 0).
- as an alternative, clear the fault memory of all drive objects (p2147 = 1).
- replace the Control Unit.

A01304 **Firmware version of DRIVE-CLiQ component is not up-to-date**
Reaction: NONE
Acknowledge: NONE
Cause: The non-volatile memory has a more recent firmware version than the one in the connected DRIVE-CLiQ component.
Alarm value (r2124, interpret decimal):
Component number of the DRIVE-CLiQ component involved.
Remedy: Update the firmware (p7828, p7829 - or commissioning tool).

A01306 **Firmware of the DRIVE-CLiQ component being updated**
Reaction: NONE
Acknowledge: NONE
Cause: Firmware update is active for at least one DRIVE-CLiQ component.
Alarm value (r2124, interpret decimal):
Component number of the DRIVE-CLiQ component.
Remedy: Not necessary.
This alarm is automatically withdrawn after the firmware update has been completed.

A01330 **Topology: Commissioning not possible**
Reaction: NONE
Acknowledge: NONE
Cause: Unable to carry out commissioning. The actual topology does not fulfill the requirements.
Remedy: - check the OCC cable between the converter and motor.
- carry out a POWER ON (switch-off/switch-on).
- Check that the connected hardware is supported.
Note:
OCC: One Cable Connection (one cable system)

F01357	Topology: Two Control Units identified on the DRIVE-CLiQ line
Reaction:	NONE
Acknowledge:	IMMEDIATELY
Cause:	<p>In the actual topology, 2 Control Units are connected with one another through DRIVE-CLiQ. As standard, this is not permitted.</p> <p>This is only permitted if the Technology Extension OALINK has already been installed on the two Control Units and has been commissioned online.</p> <p>Fault value (r0949, interpret hexadecimal): yyxx hex: yy = connection number of the Control Unit at which the second Control Unit is connected xx = component number of the Control Unit at which the second Control Unit is connected</p> <p>Note: Pulse enable is withdrawn and prevented.</p>
Remedy:	<p>In general:</p> <ul style="list-style-type: none"> - remove the connection to the second Control Unit and restart. - for the S120M component DRIVE-CLiQ extension, interchange the hybrid cable (IN/OUT). <p>When using OALINK:</p> <ul style="list-style-type: none"> - remove the DRIVE-CLiQ connection and restart the systems. - install OALINK on both Control Units and activate. - Check the configuration of the DRIVE-CLiQ sockets in OALINK.

A01489	Topology: motor with DRIVE-CLiQ not connected
Reaction:	NONE
Acknowledge:	NONE
Cause:	<p>The topology comparison has detected a motor with DRIVE-CLiQ missing in the actual topology with respect to the target topology.</p> <p>Alarm value (r2124, interpret hexadecimal): ddccbbaa hex: dd = connection number (%4) cc = component number (%3) bb = component class (% 2) aa = component number of the component that has not been inserted (% 1)</p> <p>Note: The component is described in dd, cc and bb, where the component has not been inserted. Component class and connection number are described in F01375.</p>
Remedy:	<p>Adapting topologies:</p> <ul style="list-style-type: none"> - insert the components involved at the right connection (correct the actual topology). - adapt the project/parameterizing in the commissioning tool (correct the target topology). <p>Check the hardware:</p> <ul style="list-style-type: none"> - check the 24 V supply voltage. - check DRIVE-CLiQ cables for interruption and contact problems. - check that the component is working properly. <p>Note: Under "Topology --> Topology view" the commissioning tool where relevant offers improved diagnostics capability (e.g. setpoint/actual value comparison).</p>

A01590	Drive: Motor maintenance interval expired
Reaction:	NONE
Acknowledge:	NONE

15.2 List of faults and alarms

Cause: The selected service/maintenance interval for this motor was reached.
Alarm value (r2124, interpret decimal):
Motor data set number.

Remedy: carry out service/maintenance and reset the service/maintenance interval (p0651).

F01600 SI P1: STO initiated

Reaction: OFF2

Acknowledge: IMMEDIATELY

Cause: The "Safety Integrated" function integrated in the drive has identified a fault in monitoring channel 1, and has initiated STO.
- forced checking procedure (test stop) of the safety switch-off signal path of monitoring channel 1 unsuccessful.
- subsequent response to fault F01611 (defect in a monitoring channel).
Fault value (r0949, decimal interpretation):
0: Stop request from another monitoring channel.
1005: STO active, although no STO is selected and no stop response with STO is active.
1010: STO inactive, although STO is selected or a stop response with STO is active.
9999: Subsequent response to fault F01611.

Remedy: - select Safe Torque Off and deselect again.
- replace drive.
For fault value = 9999:
- carry out diagnostics for fault F01611.
Note:
SI: Safety Integrated
STO: Safe Torque Off

F01611 SI P1: Defect in a monitoring channel

Reaction: NONE

Acknowledge: IMMEDIATELY

Cause: The "Safety Integrated" function integrated in the drive has identified a fault in monitoring channel 1. As a result of this fault, after the parameterized transition time has elapsed (p9658), fault F01600 is output.

Fault value (r0949, interpret decimal):

0: Stop request from another monitoring channel.

1 ... 999:

Number of the cross-compared data that resulted in this fault. This number is also displayed in r9795.

2: SI enable safety functions (p9601). Crosswise data comparison is only carried out for the supported bits.

3: SI SGE changeover discrepancy time (p9650).

4: SI transition time from F01611 to STO (p9658).

5: SI enable Safe Brake Control (p9602).

6: SI Motion enable safety functions (p9501).

7: SI delay time of STO for Safe Stop 1 (p9652).

8: SI PROFIsafe address (p9610).

9: SI debounce time for STO/SBC/SS1 (p9651).

14: SI PROFIsafe telegram selection (p9611).

15: SI PROFIsafe bus failure response (p9612).

1000: Watchdog timer has expired.

Within the time of approx. $5 \times p9650$, alternatively, the following was defined:

- the signal at F-DI for STO/SS1 continually changes with time intervals less than or equal to the discrepancy time (p9650).
- via PROFIsafe, STO (also as subsequent response) was continually selected and deselected with time intervals less than or equal to the discrepancy time (p9650).

1001, 1002: Initialization error, change timer / check timer.

1900: CRC error in the SAFETY sector.

1901: CRC error in the ITCM sector.

1902: Overloading in the ITCM sector has occurred in operation.

1903: Internal parameterizing error for CRC calculation.

2000: Status of the STO selection for both monitoring channels different.

2001: Feedback signal of STO shutdown for both monitoring channels different. This value can also subsequently occur as a result of other faults.

2002: Status of the delay timer SS1 on both monitoring channels are different (status of the timer in p9650).

2003: Status of the STO terminal for both monitoring channels different.

6000 ... 6999:

Error in the PROFIsafe control.

For these fault values, the failsafe control signals (Failsafe Values) are transferred to the safety functions. For p9612 = 1, the transfer of Failsafe Values is delayed.

6000: A fatal PROFIsafe communication error has occurred.

6064 ... 6071: error when evaluating the F parameter. The values of the transferred F parameters do not match the expected values in the PROFIsafe driver.

6064: Destination address and PROFIsafe address are different (F_Dest_Add).

6065: Destination address not valid (F_Dest_Add).

6066: Source address not valid (F_Source_Add).

6067: Watchdog time not valid (F_WD_Time).

6068: Incorrect SIL level (F_SIL).

6069: Incorrect F-CRC length (F_CRC_Length).

6070: Incorrect F parameter version (F_Par_Version).

6071: CRC error for the F parameters (CRC1). The transferred CRC value of the F parameters does not match the value calculated in the PROFIsafe driver.

6072: F parameterization is inconsistent.

6165: A communications error was identified when receiving the PROFIsafe telegram. The fault can also occur if an inconsistent or out-of-date PROFIsafe telegram has been received after switching the drive off and on or after plugging in the PROFINET cable.

6166: A time monitoring error (timeout) was identified when receiving the PROFIsafe telegram.

15.2 List of faults and alarms

Remedy:

For fault value = 1 ... 5 and 7 ... 999:

- check the data that caused the fault.
- carry out a POWER ON (switch-off/switch-on) for all components.
- upgrade the drive software.

For fault value = 6:

- carry out a POWER ON (switch-off/switch-on) for all components.
- upgrade the drive software.

For fault value = 1000:

Check the wiring of the F-DI for STO/SS1 (contact problems).

- PROFIsafe: Resolve contact problems/faults at the PROFINET controller.
- check the discrepancy time, and if required, increase the value (p9650).

For fault value = 1001, 1002:

- carry out a POWER ON (switch-off/switch-on) for all components.
- upgrade the drive software.

For fault value = 1900, 1901, 1902:

- carry out a POWER ON (switch-off/switch-on) for all components.
- replace drive.
- upgrade the drive software.

For fault value = 2000, 2001, 2002, 2003:

- check the discrepancy time, and if required, increase the value (p9650, p9652).
- check the wiring of the safety-relevant inputs (SGE) (contact problems).
- replace drive.
- diagnose the other active faults and resolve the causes.

Note:

This fault can be acknowledged after removing the cause of the error and after correct selection/deselection of STO.

For fault value = 6000:

- carry out a POWER ON (switch-off/switch-on) for all components.
- check whether there is a DRIVE-CLiQ communication error between the two monitoring channels and, if required, carry out a diagnostics routine for the faults identified.
- upgrade firmware to later version.
- contact Technical Support.
- replace drive.

For fault value = 6064:

- check the setting of the value in the F parameter F_Dest_Add at the PROFIsafe slave.
- check the setting of the PROFIsafe address (p9610). Using the commissioning tool, copy the safety parameters and confirm the data change.

For fault value = 6065:

- check the setting of the value in the F parameter F_Dest_Add at the PROFIsafe slave. It is not permissible for the destination address to be either 0 or FFFF!

For fault value = 6066:

- check the setting of the value in the F parameter F_Source_Add at the PROFIsafe slave. It is not permissible for the source address to be either 0 or FFFF!

For fault value = 6067:

- check the setting of the value in the F parameter F_WD_Time at the PROFIsafe slave. It is not permissible for the watch time to be 0!

For fault value = 6068:

- check the setting of the value in the F parameter F_SIL at the PROFIsafe slave. The SIL level must correspond to SIL2!

For fault value = 6069:

- check the setting of the value in the F parameter F_CRC_Length at the PROFIsafe slave. The setting of the CRC2 length is 2-byte CRC in the V1 mode and 3-byte CRC in the V2 mode!

For fault value = 6070:

- check the setting of the value in the F parameter F_Par_Version at the PROFIsafe slave. The value for the F parameter version is 0 in the V1 mode and 1 in the V2 mode!

For fault value = 6071:

- check the settings of the values of the F parameters and the F parameter CRC (CRC1) calculated from these at the PROFIsafe slave and, if required, update.

For fault value = 6072:

- check the settings of the values for the F parameters and, if required, correct.

The following combinations are permissible for F parameters F_CRC_Length and F_Par_Version:

F_CRC_Length = 2-byte CRC and F_Par_Version = 0

F_CRC_Length = 3-byte CRC and F_Par_Version = 1

For fault value = 6165:

- if the fault occurs after powering up or after inserting the PROFINET cable, acknowledge the fault.
- check the configuration and communication at the PROFIsafe slave.
- check the setting of the value for F parameter F_WD_Time on the PROFIsafe slave and increase if necessary.
- check whether there is a DRIVE-CLiQ communication error between the two monitoring channels and, if required, carry out a diagnostics routine for the faults identified.
- check whether all F parameters of the drive match the F parameters of the F host.

For fault value = 6166:

- check the configuration and communication at the PROFIsafe slave.
- check the setting of the value for F parameter F_WD_Time on the PROFIsafe slave and increase if necessary.
- evaluate diagnostic information in the F host.
- check PROFIsafe connection.
- check whether all F parameters of the drive match the F parameters of the F host.

Note:

F-DI: Failsafe Digital Input

SGE: Safety-relevant input

SI: Safety Integrated

SS1: Safe Stop 1

STO: Safe Torque Off

N01620 SI P1: Safe Torque Off active

Reaction: NONE

Acknowledge: NONE

Cause: The "Safe Torque Off" (STO) function of the basic functions has been selected in monitoring channel 1 using the input terminal and is active.

Note:

- this message does not result in a safety stop response.
- this message is not output when STO is selected using the Extended Functions.

Remedy: Not necessary.

Note:

SI: Safety Integrated

STO: Safe Torque Off

N01621 SI P1: Safe Stop 1 active

Reaction: NONE

Acknowledge: NONE

Cause: The "Safe Stop 1" function (SS1) was selected in monitoring channel 1 and is active.

Note:

This message does not result in a safety stop response.

Remedy: Not necessary.

Note:

SI: Safety Integrated

SS1: Safe Stop 1

F01625 **SI P1: sign-of-life error in the safety data**

Reaction: OFF2

Acknowledge: IMMEDIATELY

Cause: The "Safety Integrated" function integrated in the drive has identified an error in the sign-of-life of the safety data in monitoring channel 1, and has initiated STO.

- there is either a DRIVE-CLiQ communication error or communication has failed.
- a time slice overflow of the safety software has occurred.

Fault value (r0949, decimal interpretation):

Only for internal Siemens troubleshooting.

Remedy:

- select STO and then deselect again.
- carry out a POWER ON (switch-off/switch-on).
- check whether there is a DRIVE-CLiQ communication error between the two monitoring channels and, if required, carry out a diagnostics routine for the faults identified.
- deselect all drive functions that are not absolutely necessary.
- check the electrical cabinet design and cable routing for EMC compliance

Note:

SI: Safety Integrated

STO: Safe Torque Off

F01630 **SI P1: Brake control error**

Reaction: OFF2

Acknowledge: IMMEDIATELY

Cause: The "Safety Integrated" function integrated in the drive has identified a brake control fault in monitoring channel 1, and has initiated STO.

- OCC cable shield is not correctly connected.
- defect in the brake control circuit of the drive.

Fault value (r0949, decimal interpretation):

10, 11:

Fault in "open brake" operation.

- brake not closed or interrupted cable.
- ground fault in brake cable.

20:

Fault in "brake open" state.

- short-circuit in brake winding.

30, 31:

Fault in "close brake" operation.

- brake not closed or interrupted cable.
- short-circuit in brake winding.

40:

Fault in "brake closed" state.

50:

Fault in the brake control of the drive or a communication error (brake control diagnostics).

Remedy:

- select STO and then deselect again.
- check the motor holding brake connection.
- check the function of the motor holding brake.
- carry out a diagnostics routine for the faults involved.
- check for EMC-compliant control cabinet design and cable routing (e.g. shield OCC cable with shield terminal and shield plate, check the connection of the brake conductors).
- replace drive.

Note:
 OCC: One Cable Connection (one cable system)
 SBC: Safe Brake Control
 SI: Safety Integrated
 STO: Safe Torque Off
 See also: p1215 (Motor holding brake configuration)

A01631 SI P1: motor holding brake/SBC configuration not practical

Reaction: NONE
Acknowledge: NONE
Cause: A configuration of motor holding brake and SBC was detected that is not practical.
 The following configurations can result in this message:
 - "No motor holding brake available" (p1215 = 0) and "SBC" enabled (p9602 = 1).
Remedy: Check the parameterization of the motor holding brake and SBC and correct.
 Note:
 SBC: Safe Brake Control
 See also: p1215 (Motor holding brake configuration), p9602 (SI enable safe brake control)

A01637 SI: Safety password not assigned

Reaction: NONE
Acknowledge: NONE
Cause: Safety Integrated is parameterized and enabled. However, a valid safety password has still not been entered.
 See also: r9767 (SI safety password status)
Remedy: - assign a valid safety password.
 - carry out data save.

A01638 SI: Safety password entered

Reaction: NONE
Acknowledge: NONE
Cause: A valid safety password has been entered. It is possible to change safety parameters in the safety commissioning mode.
 See also: r9767 (SI safety password status)
Remedy: Not necessary.
 This alarm is automatically withdrawn with "Delete password" (e.g. after exiting the web server - or after a Power on). The password remains assigned.

F01640 SI P1: component exchange identified and acknowledge/save necessary

Reaction: NONE
Acknowledge: IMMEDIATELY

15.2 List of faults and alarms

Cause: "Safety Integrated" has identified that a component has been replaced.
It is no longer possible to operate the particular drive without fault.
When safety functions are active, after a component has been replaced it is necessary to carry out a partial acceptance test.
Fault value (r0949, interpret binary):
Bit 0 = 1:
It has been identified that the drive has been replaced.
Bit 3 = 1:
It has been identified that the Sensor Module has been replaced.
Bit 5 = 1:
It has been identified that the sensor has been replaced.

Remedy: - save all parameters
- acknowledge fault.

Note:
In addition to the fault, diagnostics bits r9776.2 and r9776.3 are set.
See also: r9776 (SI diagnostics)

F01641 **SI P1: component exchange identified and save necessary**

Reaction: NONE

Acknowledge: IMMEDIATELY

Cause: "Safety Integrated" has identified that a component has been replaced.
No additional fault response is initiated, therefore operation of the particular drive is not restricted.
When safety functions are active, after a component has been replaced it is necessary to carry out a partial acceptance test.
Fault value (r0949, interpret binary):
Bit 0 = 1:
It has been identified that the drive has been replaced.
Bit 3 = 1:
It has been identified that the Sensor Module has been replaced.
Bit 5 = 1:
It has been identified that the sensor has been replaced.

Remedy: - save all parameters
- acknowledge fault.
See also: r9776 (SI diagnostics)

F01649 **SI P1: Internal software error**

Reaction: OFF2

Acknowledge: IMMEDIATELY

Cause: An internal error in the Safety Integrated software in monitoring channel 1 has occurred.
Note:
This fault results in an STO that cannot be acknowledged.
Fault value (r0949, interpret hexadecimal):
Only for internal Siemens troubleshooting.

Remedy: - carry out a POWER ON (switch-off/switch-on).
- re-commission the "Safety Integrated" function and carry out a POWER ON.
- upgrade the drive firmware to a later version.
- contact Technical Support.
- replace drive.

Note:
SI: Safety Integrated
STO: Safe Torque Off

F01650 **SI P1: Acceptance test required****Reaction:** OFF2**Acknowledge:** IMMEDIATELY**Cause:** The "Safety Integrated" function on monitoring channel 1 requires an acceptance test.

Note:

This fault results in an STO that can be acknowledged.

Fault value (r0949, interpret decimal):

130: Safety parameters for monitoring channel 2 not available.

Note:

This fault value is always output when Safety Integrated is commissioned for the first time.

1000: Reference and actual checksum in monitoring channel 1 are not identical (booting).

- safety parameters set offline and loaded to the drive.

- at least one checksum-checked piece of data is defective.

2000: Reference and actual checksum in monitoring channel 1 are not identical (commissioning mode).

2001: Reference and actual checksum in monitoring channel 2 are not identical (commissioning mode).

2002: Enable of safety-related functions between the two monitoring channels differ.

2003: Acceptance test is required as a safety parameter has been changed.

2004: An acceptance test is required because a project with enabled safety-functions has been downloaded.

2005: The safety logbook has identified that the safety checksums have changed.

2010: Safe brake control enable different between both monitoring channels.

2020: Error when saving the safety parameters for the monitoring channel 2.

3003: Acceptance test is required as a hardware-related safety parameter has been changed.

3005: The Safety logbook has identified that a hardware-related safety checksum has changed.

9999: Subsequent response of another safety-related fault that occurred when booting that requires an acceptance test.

15.2 List of faults and alarms

Remedy:

For fault value = 130:
- carry out safety commissioning routine.

For fault value = 1000:
- again carry out safety commissioning routine.
- replace the memory card or drive.

For fault value = 2000:
- confirm the data change using the commissioning tool.

For fault value = 2001:
- confirm the data change using the commissioning tool.

For fault value = 2002:
- using the commissioning tool, copy the safety parameters and confirm the data change.

For fault value = 2003, 2004, 2005:
- carry out an acceptance test and generate an acceptance report.

Note:
The fault with fault value 2005 can only be acknowledged when the "STO" function is deselected.

For fault value = 2010:
- check that safe brake control is enabled.
- using the commissioning tool, copy the safety parameters and confirm the data change.

For fault value = 2020:
- again carry out safety commissioning routine.
- replace the memory card or drive.

For fault value = 3003:
- carry out the function checks for the modified hardware and generate an acceptance report.

For fault value = 3005:
- carry out the function checks for the modified hardware and generate an acceptance report.

Note:
The fault with fault value 3005 can only be acknowledged when the "STO" function is deselected.

For fault value = 9999:
- carry out diagnostics for the other safety-related fault that is present.

Note:
SI: Safety Integrated
STO: Safe Torque Off

F01651 **SI P1: Synchronization safety time slices unsuccessful**

Reaction: OFF2

Acknowledge: IMMEDIATELY

Cause: The "Safety Integrated" function requires a synchronization of the safety time slices between the two monitoring channels and between the drive and the higher-level control. This synchronization routine was unsuccessful.

Note:
This fault results in an STO that cannot be acknowledged.

Remedy:

- carry out a POWER ON (switch-off/switch-on).
- upgrade the drive software.
- upgrade the software of the higher-level control.

Note:
SI: Safety Integrated
STO: Safe Torque Off

F01653 **SI P1: PROFINET configuration error**

Reaction: NONE

Acknowledge: IMMEDIATELY

Cause: There is a PROFINET configuration error for using Safety Integrated monitoring functions with a higher-level control (F-PLC).
Note:
 When the safety functions are enabled, this fault results in an STO that cannot be acknowledged.
 Fault value (r0949, interpret decimal):
 200: A safety slot for receive data from the control has not been configured.
 210, 220: The configured safety slot for the receive data from the control has an unknown format.
 230: The configured safety slot for the receive data from the F-PLC has the incorrect length.
 231: The configured safety slot for the receive data from the F-PLC has the incorrect length.
 250: A PROFIsafe slot is configured in the higher-level F control, however PROFIsafe is not enabled in the drive.
 300: A safety slot for the send data to the control has not been configured.
 310, 320: The configured safety slot for the send data to the control has an unknown format.
 330: The configured safety slot for the send data to the F-PLC has the incorrect length.
 331: The configured safety slot for the send data to the F-PLC has the incorrect length.
 400: The telegram number in the F-PLC does not match the parameterization in the drive.

Remedy: The following generally applies:
 - check and, if necessary, correct the PROFINET configuration of the safety slot on the master side.
 - upgrade the drive software.
 For fault value = 250:
 - remove the PROFIsafe configuring in the higher-level F control or enable PROFIsafe in the drive.
 For fault value = 231, 331:
 - in the drive, parameterize the appropriate PROFIsafe telegram (p9611) to be set on the F-PLC.
 - configure the PROFIsafe telegram matching the parameterization (p9611) in the F-PLC.
Note:
 SI: Safety Integrated
 STO: Safe Torque Off

A01654 SI P1: Deviating PROFIsafe configuration

Reaction: NONE

Acknowledge: NONE

Cause: The configuration of a PROFIsafe telegram in the higher-level control (F-PLC) does not match the parameterization in the drive.
Note:

This message does not result in a safety stop response.

Alarm value (r2124, interpret decimal):

1:

A PROFIsafe telegram is configured in the higher-level control, however PROFIsafe is not enabled in the drive (p9601.3).

2:

PROFIsafe is parameterized in the drive; however, a PROFIsafe telegram has not been configured in the higher-level control.

Remedy:

The following generally applies:

- check and, if necessary, correct the PROFIsafe configuration in the higher-level control.

For alarm value = 1:

- remove the PROFIsafe configuring in the higher-level F control or enable PROFIsafe in the drive.

For alarm value = 2:

- configure the PROFIsafe telegram to match the parameterization in the higher-level F-control.

F01655 SI P1: Align monitoring functions

Reaction: OFF2

Acknowledge: IMMEDIATELY

15.2 List of faults and alarms

Cause: An error has occurred when aligning the Safety Integrated monitoring functions of both monitoring channels. No common set of supported SI monitoring functions was able to be determined.
- there is either a DRIVE-CLiQ communication error or communication has failed.
- no POWER ON after upgrading the firmware.

Note:

This fault results in an STO that cannot be acknowledged.

Fault value (r0949, interpret hexadecimal):

Only for internal Siemens troubleshooting.

Remedy: - carry out a POWER ON (switch-off/switch-on) for all components.
- check the electrical cabinet design and cable routing for EMC compliance
- upgrade the drive software.

Note:

SI: Safety Integrated

STO: Safe Torque Off

F01656 SI P1: Parameters monitoring channel 2 error

Reaction: OFF2

Acknowledge: IMMEDIATELY

Cause: When accessing the Safety Integrated parameters for monitoring channel 2 in the non-volatile memory, an error has occurred.

Note:

This fault results in an STO that can be acknowledged.

Fault value (r0949, interpret decimal):

129:

- safety parameters for monitoring channel 2 corrupted.
- drive with enabled safety functions was possibly copied offline using the commissioning tool and the project downloaded.
- 131: Internal software error on monitoring channel 2.
- 132: Communication errors when uploading or downloading the safety parameters for monitoring channel 2.
- 255: Internal software error on monitoring channel 1.

Remedy: - re-commission the safety functions.
- upgrade the drive software.
- replace the memory card or drive.

For fault value = 129:

- activate the safety commissioning mode (p0010 = 95).
- adapt the PROFIsafe address (p9610).
- using the commissioning tool, copy the safety parameters and confirm the data change.
- exit the safety commissioning mode (p0010 = 0).
- save all parameters (copy RAM to ROM).
- carry out a POWER ON (switch-off/switch-on).

For fault value = 132:

- check the electrical cabinet design and cable routing for EMC compliance

Note:

SI: Safety Integrated

STO: Safe Torque Off

F01657 SI P1: PROFIsafe telegram number not valid

Reaction: OFF2

Acknowledge: POWER ON

Cause: The PROFIsafe telegram number set in p9611 is not valid.
 When PROFIsafe is enabled (p9601.3 = 1), then a telegram number greater than zero must be entered in p9611.
Note:
 This fault does not result in a safety stop response.
 See also: p9611 (SI PROFIsafe telegram selection), r60022 (PROFIsafe telegram selection)

Remedy: Check the telegram number setting (p9611).

F01658 SI P1: PROFIsafe telegram numbers differ

Reaction: OFF2
Acknowledge: IMMEDIATELY
Cause: The PROFIsafe telegram number is set differently in p9611 and r60022.
 The telegram number must be identically set in both parameters.
Note:
 This fault does not result in a safety stop response.
 See also: p9611 (SI PROFIsafe telegram selection), r60022 (PROFIsafe telegram selection)

Remedy: Align the telegram number in both parameters so that they are the same (p9611, r60022).

F01659 SI P1: Write request for parameter rejected

Reaction: OFF2
Acknowledge: IMMEDIATELY
Cause: The write request for one or several Safety Integrated parameters from monitoring channel 1 was rejected.
Note:
 This fault does not result in a safety stop response.
 Fault value (r0949, interpret decimal):
 1: The Safety Integrated password is not set.
 14: An attempt was made to enable the PROFIsafe communication - although the version of the PROFIsafe driver used on both monitoring channels is different.
 20: An attempt was made to enable the motion monitoring functions integrated in the drive and the STO function, both controlled via F-DI.
 25: An attempt was made to parameterize a PROFIsafe telegram although this cannot be supported.
 27: An attempt was made to activate the Basic Functions by controlling via TM54F although this is not supported.
 28: An attempt was made to enable the "STO via terminals at the Power Module" function although this cannot be supported.
 9612: An attempt was made to set the stop response SS1 for PROFIsafe failure (p9612 = 1), although PROFIsafe is not enabled.

15.2 List of faults and alarms

Remedy:

For fault value = 1:
- set the Safety Integrated password.

For fault value = 14, 27:
- check whether there are faults in the safety function alignment between the two monitoring channels (F01655, F30655) and if required, carry out diagnostics for the faults involved.
- upgrade the drive software.

For fault value = 20:
- correct the enable setting (p9601).

For fault value = 25:
- correct the telegram number setting (p9611).

For fault value = 28:
- correct the enable setting (p9601.7 = 0).

For fault value = 9612:
- establish communications with PROFIsafe (p9601).
- parameterize STO as stop response for PROFIsafe failure (p9612 = 0).

Note:
F-DI: Failsafe Digital Input
SBC: Safe Brake Control
SI: Safety Integrated
SS1: Safe Stop 1
STO: Safe Torque Off

See also: p9501 (SI Motion enable safety functions), p9601 (SI enable, functions integrated in the drive), p9612 (SI PROFIsafe failure response)

F01663 **SI P1: copying SI parameters rejected**

Reaction: OFF2

Acknowledge: IMMEDIATELY

Cause: The copy function for Safety Integrated parameters is initiated using the commissioning tool.
This is the reason that when booting, an attempt is made to copy Safety Integrated parameters from monitoring channel 1 to monitoring channel 2. However, no safety-relevant function has been selected in monitoring channel 1 (p9501 = 0, p9601 = 0). Copying was rejected for safety reasons.
As a consequence, inconsistent parameterization can occur in both monitoring channels, which in turn results in additional error messages.
Especially for inconsistent enabling of the safety functions on both monitoring channels, fault F30625 is output.

Note:
This fault does not result in a safety stop response.
SI: Safety Integrated

Remedy:

- check p9501 and p9601 and if required, correct.
- perform copy function using the commissioning tool.
- save all parameters or "Copy RAM to ROM".
- carry out a POWER ON (switch-off/switch-on).

F01670 **SI Motion: Invalid parameterization of the encoder evaluation**

Reaction: OFF2

Acknowledge: IMMEDIATELY

Cause: The parameterization of the encoder evaluation used for Safety Integrated is not permissible.

Note:
 This fault results in an STO that cannot be acknowledged.
 Fault value (r0949, interpret decimal):
 1: No encoder was parameterized for Safety Integrated.
 2: An encoder was parameterized for Safety Integrated that does not have an A/B track (sine/cosine).
 3: The encoder data set selected for Safety Integrated is still not valid.
 4: A communication error with the encoder has occurred.
 5: Number of relevant bits in the encoder coarse position invalid.
 6: DRIVE-CLiQ encoder configuration invalid.
 8: Parameterized Safety comparison algorithm not supported.

Remedy:
 For fault value = 1, 2:
 - use and parameterize an encoder that Safety Integrated supports (encoder with track A/B sine-wave, p0404.4 = 1).
 For fault value = 3:
 - check whether the drive or drive commissioning function is active and if required, exit this (p0009 = p00010 = 0), save the parameters (p0971 = 1) and carry out a POWER ON
 For fault value = 4:
 - check whether there are any active faults in the DRIVE-CLiQ communication between the drive and the encoder evaluation - and when necessary, carry out diagnostics for the faults involved.
 For fault value = 5:
 - p9525 = 0 (not permissible). Check the encoder parameterization.
 For fault value = 6:
 - check p9515.0 (for DRIVE-CLiQ encoders, the following applies: p9515.0 = 1). Check the encoder parameterization.
 For fault value = 8:
 - use and parameterize an encoder that implements an algorithm supported by Safety Integrated.

Note:
 SI: Safety Integrated
 STO: Safe Torque Off

F01671 **SI Motion: Parameterization encoder error**

Reaction: OFF2

Acknowledge: IMMEDIATELY

Cause: The parameterization of the encoder used by Safety Integrated is different to the parameterization of the standard encoder.

Note:
 This fault does not result in a safety stop response.
 Fault value (r0949, interpret decimal):
 Parameter number of the non-corresponding safety parameter.

Remedy: Align the encoder parameterization between the safety encoder and the standard encoder.

Note:
 SI: Safety Integrated

F01672 **SI P1: drive is incompatible regarding software/hardware**

Reaction: OFF2

Acknowledge: IMMEDIATELY

Cause: The software for monitoring channel 2 does not support safe motion monitoring, is not compatible to the software for monitoring channel 1 - or there is a communications error between the two monitoring channels.

Note:
 This fault results in an STO that cannot be acknowledged.
 Fault value (r0949, decimal interpretation):
 Only for internal Siemens troubleshooting.

15.2 List of faults and alarms

Remedy: - check whether faults F01655/F30655 are active - and when necessary, carry out diagnostics for the faults involved.
- upgrade the drive software.
Note:
SI: Safety Integrated
STO: Safe Torque Off

F01673 **SI Motion: Sensor Module software/hardware incompatible**
Reaction: OFF2
Acknowledge: IMMEDIATELY
Cause: The existing Sensor Module software and/or hardware does not support the safe motion monitoring function with the higher-level control.
Note:
This fault does not result in a safety stop response.
Fault value (r0949, interpret decimal):
Only for internal Siemens troubleshooting.
Remedy: - upgrade the Sensor Module software.
- use a Sensor Module that supports the safe motion monitoring function.
Note:
SI: Safety Integrated

F01674 **SI Motion P1: Safety function not supported by PROFIsafe telegram**
Reaction: OFF2
Acknowledge: POWER ON
Cause: The monitoring function enabled in p9501 and p9601 is not supported by the currently set PROFIsafe telegram (p9611).
Note:
This fault results in an STO that cannot be acknowledged.
Fault value (r0949, interpret bitwise):
Bit 18 = 1:
SS2E via PROFIsafe is not supported (p9501.18).
Bit 24 = 1:
Transfer SLS (SG) limit value via PROFIsafe not supported (p9501.24).
Bit 25 = 1:
Transfer safe position (SP) via PROFIsafe is not supported (p9501.25).
Bit 26 = 1:
Gearbox stage switchover via PROFIsafe is not supported (p9501.26).
Bit 28 = 1:
SCA via PROFIsafe is not supported (p9501.28).
Remedy: - Deselect the monitoring function involved (p9501, p9601).
- set the matching PROFIsafe telegram (p9611).
Note:
SCA: Safe Cam
SI: Safety Integrated
SLS: Safely-Limited Speed
SP: Safe Position
SS2E: Safe Stop 2 External (Safe Stop 2 with external stop)
STO: Safe Torque Off

F01675 **SI Motion P1: settings in the PROFINET controller not permissible**
Reaction: OFF2
Acknowledge: IMMEDIATELY

Cause: For the "Safe synchronous position via PROFIsafe" function, an incorrect configuration setting was identified.

Note:
 This fault results in an STO that can be acknowledged as follows.
 - select STO and then deselect again.
 - internal event acknowledge (if the "Extended message acknowledgment" is active, p9507.0 = 1).

Fault value (r0949, interpret decimal):
 1:
 "Synchronous safe position via PROFIsafe" is enabled (p9501.29 = 1) and is not set according to the rule $Tdp = 2 \times n \times p9500$ ($n = 1, 2, 3, \dots$).
 2:
 "Synchronous safe position via PROFIsafe" is enabled (p9501.29 = 1) and isochronous operation is not set.

Note:
 SI: Safety Integrated
 STO: Safe Torque Off

Remedy: For fault value = 1:
 - set bus cycle time Tdp and monitoring clock cycle p9500 according to the rule $Tdp = 2 \times n \times p9500$ ($n = 1, 2, 3, \dots$).
 For fault value = 2:
 - set "Isochronous mode" on the PROFINET controller.

F01679 **SI P1: Safety parameter settings and topology changed, warm restart/POWER ON required**

Reaction: OFF2

Acknowledge: POWER ON

Cause: Safety parameters have been changed; these will only take effect following a warm restart or POWER ON (see alarm A01693).
 A partial power up (boot) with modified configuration was then performed.

Remedy: - carry out a warm restart.
 - carry out a POWER ON (switch-off/switch-on).

F01680 **SI Motion P1: Checksum error safety monitoring functions**

Reaction: OFF2

Acknowledge: IMMEDIATELY

Cause: The calculated actual checksum over the safety-relevant parameters does not match the reference checksum saved at the last machine acceptance.
 Safety-relevant parameters have been changed or a fault is present.

Note:
 This fault results in an STO that can be acknowledged.
 Fault value (r0949, decimal interpretation):
 0: Checksum error for SI parameters for motion monitoring.
 1: Checksum error for SI parameters for actual values.
 2: Checksum error for SI parameters for component assignment.

Remedy: - check the safety-relevant parameters and if required, correct.
 - execute the function "Copy RAM to ROM".
 - if necessary carry out a POWER ON (switch-off/switch-on).
 - carry out an acceptance test.

Note:
 STO: Safe Torque Off

F01681 **SI Motion P1: Incorrect parameter value**

Reaction: OFF2

Acknowledge: IMMEDIATELY

15.2 List of faults and alarms

Cause: The parameter cannot be parameterized with this value.

Note:
This message does not result in a safety stop response.
Fault value (r0949, interpret decimal):
yyyyxxxx dec: yyyy = supplementary information, xxxx = parameter
yyyy = 0:
No additional information available.
xxxx = 9501:
Enabling function "SSM" (p9501.16) is not permissible in combination with the "Extended functions without selection" function (p9601.5).
xxxx = 9501 and yyyy = 10:
Referencing via SCC (p9501.27 = 1) and epos (r0108.4 = 1) are simultaneously enabled.
xxxx = 9506 and yyyy = 1:
Parameter p9506 differs between the monitoring channels
xxxx = 9522:
The gear stage was set too high.
xxxx = 9547:
The hysteresis tolerance is not permissible.
xxxx = 9601 and yyyy = 1:
If motion monitoring functions integrated in the drive (p9601.2 = 1) and extended functions without selection (p9601.5 = 1) are enabled, then PROFIsafe (p9601.3 = 1) or onboard F-DI (p9601.4 = 1) is not possible.
xxxx = 9601 and yyyy = 2:
Extended functions without selection (p9601.5 = 1) are enabled without enabling motion monitoring functions integrated in the drive (p9601.2).
xxxx = 9601 and yyyy = 3:
Onboard F-DI are enabled without enabling motion monitoring functions integrated in the drive (p9601.2).
xxxx = 9601 and yyyy = 4:
Onboard F-DI are enabled. Then, it is not permissible to simultaneously set PROFIsafe and F-DI via PROFIsafe (p9501.30).
xxxx = 9601 and yyyy = 5:
Transfer of the SLS limit value via PROFIsafe (p9501.24) has been enabled, without enabling PROFIsafe.
xxxx = 9601 and yyyy = 6:
Transfer of the safe position via PROFIsafe (p9501.25) has been enabled, without enabling PROFIsafe.
xxxx = 9601 and yyyy = 7:
Safe switchover of the gearbox stages (p9501.26) has been enabled without enabling PROFIsafe.
xxxx = 9601 and yyyy = 11:
SS2E (p9501.18 = 1) is enabled without PROFIsafe being enabled.
xxxx = 9601 and yyyy = 12:
SCA (p9501.28 = 1) is enabled without enabling PROFIsafe.
xxxx = 9601 and yyyy = 13:
Extended functions (p9601.2 = 1) have been enabled without enabling PROFIsafe (p9601.3).

Remedy:

Correct parameters:

If xxxx = 9501:

- deselect extended functions without selection (p9601.5).

If xxxx = 9501 and yyyy = 10:

Deselect referencing via SCC (p9501.27).

For xxxx = 9501 and yyyy = 11:

Deselect SS2E (p9501.18) - or enable PROFIsafe

For xxxx = 9501 and yyyy = 12:

Deselect SCA (p9501.28).

If xxxx = 9507:

Set synchronous motor.

If xxxx = 9506:

Using the commissioning tool, copy the safety parameters, confirm the data change, backup the parameters and carry out a power on.

If xxxx = 9522:

Correct the corresponding parameter.

If xxxx = 9547:

With hysteresis/filtering enabled (p9501.16 = 1), the following applies:

- set parameters p9546 and p9547 according to the following rule: $p9547 \leq 0.75 \times p9546$;
- the following rule must also be adhered to when actual value synchronization (p9501.3 = 1) is enabled: $p9547 \geq p9549$;

If xxxx = 9601:

yyyy = 1:

Only enable motion monitoring functions integrated in the drive (p9601.2 = 1) and PROFIsafe (p9601.3 = 1).

yyyy = 2:

Deselect Extended Functions without selection (p9601.5 = 0)

yyyy = 3:

Deselect F-DI (p9601.4)

yyyy = 4:

Deselect onboard F-DI (p9601.4) and F-DI via PROFIsafe (p9501.30).

yyyy = 5:

To transfer the SLS limit values via PROFIsafe (p9501.24 = 1), also enable PROFIsafe (p9601.3 = 1) and motion monitoring functions integrated in the drive (p9601.2 = 1).

yyyy = 6:

Deselect the transfer of the safe position via PROFIsafe (p9501.25 = 0)

yyyy = 7:

Deselect the safe switchover of gearbox stages (p9501.26 = 1)

yyyy = 13:

Also enable PROFIsafe (p9601.3) for the extended functions (p9601.2)

Note:

SSM: Safe Speed Monitor (safety-relevant feedback signal from the speed monitoring)

F01682 SI Motion P1: Monitoring function not supported

Reaction: OFF2

Acknowledge: IMMEDIATELY

15.2 List of faults and alarms

Cause: The monitoring function enabled in p9501, p9506, p9507, p9601 is not supported in this firmware version.
Note:
This fault results in an STO that cannot be acknowledged.
Fault value (r0949, interpret decimal):
20: Motion monitoring functions integrated in the drive are only supported in conjunction with PROFIsafe (p9501 and p9601.1 ... 2).
21: Enable a safe motion monitoring function (in p9501), not supported for enabled basic functions via PROFIsafe (p9601.2 = 0, p9601.3 = 1).
59: Safe actual value sensing with SIL3 encoder not supported.
9612: An attempt was made to set the stop response SS1 for PROFIsafe failure (p9612 = 1), although PROFIsafe is not enabled.
Additional fault values:
Monitoring function not supported.
See also: p9612 (SI PROFIsafe failure response)

Remedy: - deselect the monitoring function involved (p9501, p9506, p9507, p9601).
- restore the factory setting and repeat commissioning.
- upgrade the firmware.
For fault value = 59:
- upgrade the firmware of the Motor Module to a later version.
For fault value = 9612:
- establish communications with PROFIsafe (p9601).
- parameterize STO as stop response for PROFIsafe failure (p9612 = 0).
Note:
SI: Safety Integrated
SS1: Safe Stop 1
STO: Safe Torque Off
See also: p9501 (SI Motion enable safety functions), p9601 (SI enable, functions integrated in the drive), p9612 (SI PROFIsafe failure response)

F01683 SI Motion P1: SOS/SLS enable missing

Reaction: OFF2
Acknowledge: IMMEDIATELY
Cause: The safety-relevant basic function "SOS/SLS" is not enabled in p9501 although other safety-relevant monitoring functions are enabled.
Note:
This fault does not result in a safety stop response.

Remedy: Enable the function "SOS/SLS" (p9501.0) and carry out a POWER ON.
Note:
SI: Safety Integrated
SLS: Safely-Limited Speed
SOS: Safe Operating Stop
See also: p9501 (SI Motion enable safety functions)

F01685 SI Motion P1: Safely-Limited Speed limit value too high

Reaction: OFF2
Acknowledge: IMMEDIATELY
Cause: The limit value for the function "Safely-Limited Speed" (SLS) is greater than the speed that corresponds to an encoder limit frequency of 500 kHz.
Note:
This fault does not result in a safety stop response.
Fault value (r0949, interpret decimal):
Maximum permissible speed.

Remedy: Correct the limit values for SLS and carry out a POWER ON.
 Note:
 SI: Safety Integrated
 SLS: Safely-Limited Speed
 See also: p9531 (SI Motion SLS limit values)

F01689 SI Motion: Axis re-configured

Reaction: OFF2

Acknowledge: POWER ON

Cause: The axis configuration was changed, and internally set to the correct value.

Note:

This fault does not result in a safety stop response.

Fault value (r0949, interpret decimal):

Number of the parameter that initiated the change.

Remedy: The following should be carried out after the changeover:

- exit the safety commissioning mode (p0010).
- save all parameters
- carry out a POWER ON.

Once the drive has been powered up, message F01680 or F30680 indicates that the checksums have changed in the drive.

The following must, therefore, be carried out:

- activate safety commissioning mode again.
- complete safety commissioning of the drive.
- exit the safety commissioning mode (p0010).
- save all parameters
- carry out a POWER ON.

Note:

For the commissioning tool, the units are only consistently displayed after a project upload.

F01690 SI Motion: Data save problem for the NVRAM

Reaction: NONE

Acknowledge: POWER ON

Cause: There is not sufficient memory space in the NVRAM on the drive to save parameters r9781 and r9782 (safety logbook).

Note:

This fault does not result in a safety stop response.

Fault value (r0949, interpret decimal):

1: There is no longer any free memory space in the NVRAM.

Remedy: For fault value = 1:

- deselect functions that are not required and that take up memory space in the NVRAM.
- contact Technical Support.

Note:

NVRAM: Non-Volatile Random Access Memory (non-volatile read and write memory)

A01691 SI Motion: Ti and To unsuitable for PN cycle

Reaction: NONE

Acknowledge: NONE

15.2 List of faults and alarms

Cause: The configured times for PROFINET communication are not permitted and the PN cycle is used as the actual value acquisition cycle for the safe movement monitoring functions:
Isochronous PROFINET:
The sum of T_i and T_o is too high for the selected PN cycle. The PN clock cycle should be at least 1 current controller cycle greater than the sum of T_i and T_o .
No isochronous PROFINET:
The PN clock cycle must be at least 4x the current controller clock cycle.
Notice:
If this alarm is not observed, then message A01711 or A30711 – with the value 1020 ... 1021 – can sporadically occur.

Remedy: Configure T_i and T_o low so that they are suitable for the PN cycle or increase the PN cycle time.

A01693 **SI P1: Safety parameter settings changed, warm restart/POWER ON required**

Reaction: NONE

Acknowledge: NONE

Cause: Safety parameters have been changed; these will only take effect following a warm restart or POWER ON.
Alarm value (r2124, interpret decimal):
Parameter number of the safety parameter which has changed, necessitating a warm restart or POWER ON.

Remedy: - carry out a warm restart.
- carry out a POWER ON (switch-off/switch-on).
Note:
A POWER ON is required before carrying out the acceptance test.

F01694 **SI Motion P1: Firmware version monitoring channel 2 older than monitoring channel 1**

Reaction: OFF2

Acknowledge: IMMEDIATELY

Cause: The firmware version of monitoring channel 2 is older than monitoring channel 1.
Note:
This message does not result in a safety stop response.
This message can occur, if after an automatic firmware update, a POWER ON was not carried out (Alarm A01007).

Remedy: Carry out a POWER ON at the drive (switch-off/switch-on).
See also: r9590 (SI Motion version, safe motion monitoring functions)

A01695 **SI Motion: Sensor Module was replaced**

Reaction: NONE

Acknowledge: NONE

Cause: A Sensor Module, which is used for safe motion monitoring functions, was replaced. The hardware replacement must be acknowledged. An acceptance test must be subsequently performed.
Note:
This message does not result in a safety stop response.

Remedy: - save all parameters
- acknowledge fault.

A01696 **SI Motion: Test stop for the motion monitoring functions selected when booting**

Reaction: NONE

Acknowledge: NONE

Cause: The forced checking procedure (test stop) for the safe motion monitoring functions is already selected when booting, which is not permissible.
This is the reason that the test is only carried out again after first selecting the forced checking procedure.
Note:
This message does not result in a safety stop response.

Remedy: Deselect the forced checking procedure (test stop) for the safe motion monitoring functions and then select again.
SI: Safety Integrated

A01697 SI Motion: Test stop for motion monitoring functions required

Reaction: NONE

Acknowledge: NONE

Cause: The time set in p9559 for the forced checking procedure (test stop) for the safe motion monitoring functions has been exceeded. A new forced checking procedure is required.
After the next time the forced checking procedure is selected, the message is withdrawn and the monitoring time is reset.
Note:

- this message does not result in a safety stop response.
- As the switch-off signal paths are not automatically checked during booting, an alarm is always issued once booting is complete.
- the test must be performed within a defined, maximum time interval (p9559, maximum of 9000 hours) in order to comply with the requirements as laid down in the standards for timely fault detection and the conditions to calculate the failure rates of safety functions (PFH value). Operation beyond this maximum time period is permissible if it can be ensured that the forced checking procedure is performed before persons enter the hazardous area and who are depending on the safety functions correctly functioning.

See also: p9559 (SI Motion forced checking procedure timer), r9765 (SI Motion forced checking procedure remaining time)

Remedy: Carry out the forced checking procedure (test stop) for the safe motion monitoring functions.

Note:

SI: Safety Integrated

A01698 SI P1: Commissioning mode active

Reaction: NONE

Acknowledge: NONE

Cause: The commissioning of the "Safety Integrated" function is selected.

Note:

- this message does not result in a safety stop response.
- in the safety commissioning mode, the "STO" function is internally selected.

See also: p0010 (Drive commissioning parameter filter 2)

Remedy: Not necessary.

This message is automatically withdrawn after the safety functions have been commissioned.

Note:

SI: Safety Integrated

STO: Safe Torque Off

A01699 SI P1: Test stop for STO required

Reaction: NONE

Acknowledge: NONE

Cause: The time set in p9659 for the forced checking procedure (test stop) for the "STO" function has been exceeded. A new forced checking procedure is required.

After the next time the "STO" function is deselected, the message is withdrawn and the monitoring time is reset.

Note:

- this message does not result in a safety stop response.
- the test must be performed within a defined, maximum time interval (p9659) in order to comply with the requirements as laid down in the standards for timely fault detection and the conditions to calculate the failure rates of safety functions (PFH value). Operation beyond this maximum time period is permissible if it can be ensured that the forced checking procedure is performed before persons enter the hazardous area and who are depending on the safety functions correctly functioning.

See also: p9659 (SI forced checking procedure timer), r9660 (SI forced checking procedure remaining time)

15.2 List of faults and alarms

Remedy: Select STO and then deselect again.

Note:

SI: Safety Integrated

STO: Safe Torque Off

F01700 SI Motion P1: STO initiated

Reaction: OFF2

Acknowledge: IMMEDIATELY

Cause: The drive is stopped using STO.

Possible causes:

- stop request from another monitoring channel.
- STO not active after parameterized time (p9557) after test stop selection.
- subsequent response, following messages: A01706, A01714, F01701, A01716

Remedy:

- remove the cause of the fault on the second monitoring channel.
- carry out diagnostics for the active messages (A01706, A01714, F01701, A01716).
- check the value in p9557 (where available), increase the value if necessary, and carry out a POWER ON
- check the switch-off signal path of monitoring channel 1 (check DRIVE-CLiQ communication if it has been implemented)
- replace drive.

Note:

SAM: Safe Acceleration Monitor (safe acceleration monitoring)

SI: Safety Integrated

STO: Safe Torque Off

F01701 SI Motion P1: SS1 initiated

Reaction: NONE

Acknowledge: IMMEDIATELY

Cause: The drive is stopped using SS1.

As a result of this fault, after the time parameterized in p9556 has expired, or the speed threshold parameterized in p9560 has been fallen below, message F01700 "STO initiated" is output.

Possible causes:

- stop request from another monitoring channel.
- subsequent response, following messages: A01714, A01711, A01707, A01716

Remedy:

- remove the cause of the fault on the second monitoring channel.
- carry out diagnostics for the active messages (A01714, A01711, A01707, A01716).

Note:

This message can be acknowledged via PROFIsafe (safe acknowledgment).

SI: Safety Integrated

SS1: Safe Stop 1

A01706 SI Motion P1: SAM/SBR limit exceeded

Reaction: NONE

Acknowledge: NONE

Cause: Motion monitoring functions with SAM (p9506 = 0):

- after initiating SS1 or SS2, the speed exceeded the set tolerance.

Motion monitoring functions with SBR (p9506 = 2):

- after initiating SS1 or SLS switchover to the lower speed level, the speed exceeded the set tolerance.

The drive is stopped by message F01700.

Remedy: Check the braking behavior and, if necessary, adapt the parameterization of the parameter settings of the "SAM" or the "SBR" function.

Note:
 This message can be acknowledged via PROFIsafe (safe acknowledgment).
 SAM: Safe Acceleration Monitor (safe acceleration monitoring)
 SBR: Safe Brake Ramp (safe ramp monitoring)
 SI: Safety Integrated
 SS1: Safe Stop 1
 SS2: Safe Stop 2
 SLS: Safely-Limited Speed
 See also: p9548 (SI Motion SAM actual speed tolerance), p9581 (SI Motion brake ramp reference value), p9582 (SI Motion brake ramp delay time), p9583 (SI Motion brake ramp monitoring time)

A01707 SI Motion P1: Tolerance for safe operating stop exceeded

Reaction: NONE

Acknowledge: NONE

Cause: The actual position has moved further away from the target position than the standstill tolerance.
 The drive is stopped by message F01701.

Remedy: - check whether safety faults are present and if required carry out the appropriate diagnostic routines for the particular faults.
 - check whether the standstill tolerance matches the accuracy and control dynamic performance of the axis.
 - carry out a POWER ON (switch-off/switch-on).

Note:
 SI: Safety Integrated
 SOS: Safe Operating Stop
 See also: p9530 (SI Motion standstill tolerance)

F01708 SI Motion P1: SS2 initiated

Reaction: STOP2

Acknowledge: IMMEDIATELY

Cause: The drive is stopped using SS2 (braking along the OFF3 down ramp).
 "Safe Operating Stop" (SOS) is activated after the parameterized time has expired.
 Possible causes:

Subsequent response, following messages: A01714, A01716
 See also: p9552 (SI Motion transition time SS2 to SOS)

Remedy: Carry out diagnostics for the active messages (A01714, A01716).

Note:
 SI: Safety Integrated
 SOS: Safe Operating Stop
 SS2: Safe Stop 2

A01709 SI Motion P1: SS2E initiated

Reaction: NONE

Acknowledge: NONE

Cause: The drive is stopped using SS2E (braking along a path).
 "Safe Operating Stop" (SOS) is activated after the parameterized time has expired.
 Possible causes:

Subsequent response, following messages: A01714, A01716
 See also: p9553 (SI Motion transition time SS2E to SOS)

15.2 List of faults and alarms

Remedy: - remove the cause of the fault at the control.
- carry out diagnostics for the active messages (A01714, A01716).

Note:

SI: Safety Integrated

SOS: Safe Operating Stop

SS2E: Safe Stop 2 External (Safe Stop 2 with external stop)

A01711 **SI Motion P1: Defect in a monitoring channel**

Reaction: NONE

Acknowledge: NONE

- Cause:** The drive has identified a difference between the input data or results of the monitoring functions and initiated A01711. Safe operation is no longer possible.
- At least one monitoring function is active, so that after the parameterized timer has expired, message F01701 is output. The message value that resulted in this message is shown in r9725.
- The following described message values involve the data cross-check between the two monitoring channels (safety functions integrated in the drive).
- The message values may also occur in the following cases if the cause that is explicitly mentioned does not apply:
- For message values 3, 44 ... 57, 232 and 1-encoder system, differently set encoder parameters.
 - incorrect synchronization.
- Message value (r2124, interpret decimal):
- 0 to 999: Number of the cross-compared data that resulted in this fault.
- Message values that are not subsequently listed are only for internal Siemens troubleshooting.
- 0: Stop request from another monitoring channel.
- 1: Status image of monitoring functions SOS, SLS, SAM/SBR or SDI (result list 1) (r9710[0], r9710[1]).
- 2: Status image of monitoring function SSM (result list 2) (r9711[0], r9711[1]).
- 3: The position actual value differential (r9713[0/1]) between the two monitoring channels is greater than the tolerance in p9542.
- 4: Error when synchronizing the data cross-check between the two channels.
- 5: Enable safe functions (p9501).
- 6: Limit value for SLS1 (p9531[0]).
- 7: Limit value for SLS2 (p9531[1]).
- 8: Limit value for SLS3 (p9531[2]).
- 9: Limit value for SLS4 (p9531[3]).
- 10: Standstill tolerance (p9530).
- 31: Position tolerance (p9542).
- 33: Time, speed switchover (p9551)
- 35: Delay time STO (p9556).
- 36: Test time, STO (p9557).
- 37: Transition time SS2 to SOS (p9552).
- 38: Transition time SS2E to SOS (p9553).
- 42: Shutdown speed STO (p9560).
- 43: Memory test stop response (STO).
- 44 ... 57: General
- Possible cause 1 (during commissioning or parameter modification)
- The tolerance value for the monitoring function is not the same on the two monitoring channels.
- Possible cause 2 (during active operation)
- The limit values are based on the actual value (r9713[0/1]). If the safe actual values on the two monitoring channels do not match, the limit values, which have been set at a defined interval, will also be different (i.e. corresponding to message value 3). This can be ascertained by checking the safe actual positions.
- Permissible deviation between the two monitoring channels: p9542.
- 44: Position actual value (r9713[0/1]) + limit value SLS1 (p9531[0]) * safety monitoring clock cycle.
- 45: Position actual value (r9713[0/1]) + limit value SLS1 (p9531[0]) * safety monitoring clock cycle.
- 46: Position actual value (r9713[0/1]) + limit value SLS2 (p9531[1]) * safety monitoring clock cycle.
- 47: Position actual value (r9713[0/1]) + limit value SLS2 (p9531[1]) * safety monitoring clock cycle.
- 48: Position actual value (r9713[0/1]) + limit value SLS3 (p9531[2]) * safety monitoring clock cycle.
- 49: Position actual value (r9713[0/1]) - limit value SLS3 (p9531[2]) * safety monitoring clock cycle.
- 50: Position actual value (r9713[0/1]) + limit value SLS4 (p9531[3]) * safety monitoring clock cycle.
- 51: Position actual value (r9713[0/1]) - limit value SLS4 (p9531[3]) * safety monitoring clock cycle.
- 52: Standstill position + tolerance (p9530).
- 53: Standstill position - tolerance (p9530).
- 54: Position actual value (r9713[0/1]) + limit value of SSM (p9546) * safety monitoring clock cycle + tolerance (p9542).
- 55: Position actual value (r9713[0/1]) + limit value of SSM (p9546) * safety monitoring clock cycle.
- 56: Position actual value (r9713[0/1]) - limit value of SSM (p9546) * safety monitoring clock cycle.

15.2 List of faults and alarms

- 57: Position actual value (r9713[0/1]) - limit value of SSM (p9546) * safety monitoring clock cycle - tolerance (p9542).
- 58: Actual stop request.
- 75: Velocity limit of SSM (p9546).
- When function "SSM" is enabled (p9501.16 = 1), then this message value is output - also for a different hysteresis tolerance (p9547).
- 76: Stop response for SLS1 (p9563[0]).
- 77: Stop response for SLS2 (p9563[1]).
- 78: Stop response for SLS3 (p9563[2]).
- 79: Stop response for SLS4 (p9563[3]).
- 81: Velocity tolerance for SAM (p9548).
- 82: SGEs for SLS correction factor.
- 83: Acceptance test timer (p9558).
- 84: Transition time A01711 (p9555).
- 89: Encoder limit frequency.
- 230: Filter time constant for SSM.
- 231: Hysteresis tolerance for SSM.
- 232: Smoothed velocity actual value.
- 233: Limit value of SSM / safety monitoring clock cycle + hysteresis tolerance.
- 234: Limit value of SSM / safety monitoring clock cycle.
- 235: -Limit value of SSM / safety monitoring clock cycle.
- 236: -Limit value of SSM / safety monitoring clock cycle - hysteresis tolerance.
- 237: SGA SSM.
- 238: Speed limit value for SAM (p9568 or p9546).
- 239: Acceleration for SBR (p9581 and p9583).
- 240: Inverse value of acceleration for SBR (p9581 and p9583).
- 241: Deceleration time for SBR (p9582).
- 242: Function specification (p9506).
- 243: Function configuration (p9507).
- 247: SDI tolerance (p9564).
- 248: SDI positive upper limit (7FFFFFFF hex).
- 249: Position actual value (r9713[0/1]) - SDI tolerance (p9564).
- 250: Position actual value (r9713[0/1]) + SDI tolerance (p9564).
- 251: SDI negative lower limit (80000001 hex).
- 252: SDI stop response (p9566).
- 253: SDI delay time (p9565).
- 256: Status image of monitoring functions SOS, SLS, test stop, SBR, SDI (result list 1 ext) (r9710).
- 259: PROFIsafe telegram (p9611) is different between the monitoring channels.
- 261: Scaling factor for acceleration for SBR different.
- 262: Scaling factor for the inverse value of the acceleration for SBR different.
- 265: Status image of all change functions (results list 1) (r9710).
- 270: Screen form for SGE image: all functions, which are not supported/enabled for the actual parameterization (p9501, p9601 and p9506).
- 273: speed limit value for flattening the ramp for SAM/SBR different.
- 276: Limit value for SLA1 (p9578/p9378).
- 277: Stop response for SLA1 (p9579/p9379).
- 278: Upper limit value for SLA1.
- 279: Lower limit value for SLA1.
- 280: Upper limit value for SLA1 (fine resolution).
- 281: Lower limit value for SLA1 (fine resolution).
- 282: SLA filter time (p9576/p9376).
- 283: Acceleration actual value (fine resolution).
- 1000: Watchdog timer has expired. Too many signal changes have occurred at safety-relevant inputs.
- 1001: Initialization error of watchdog timer.

1005: STO already active for test stop selection.

1011: Acceptance test status between the monitoring channels differ.

1012: Plausibility violation of the encoder actual value.

1020: Cyc. communication failure between the monit. channels.

1021: Cyclic communication failure between the monitoring channel and encoder evaluation.

1022: Sign-of-life error for DRIVE-CLiQ encoders monitoring channel 1.

1023: Error in the effectiveness test in the DRIVE-CLiQ encoder

1032: Sign-of-life error for DRIVE-CLiQ encoders monitoring channel 2.

1033: Error checking offset between POS1 and POS2 for DRIVE-CLiQ encoder monitoring channel 1.

1034: Error checking offset between POS1 and POS2 for DRIVE-CLiQ encoder monitoring channel 2.

1035: offset between POS1 and POS2 for DRIVE-CLiQ encoder on one of the monitoring channels has changed since the last commissioning.

1039: Overflow when calculating the position.

5000 ... 5140:
PROFIsafe message values.
For these message values, the failsafe control signals (Failsafe Values) are transferred to the safety functions.

5000, 5014, 5023, 5024, 5030 ... 5032, 5042, 5043, 5052, 5053, 5068, 5072, 5073, 5082 ... 5087, 5090, 5091, 5122 ... 5125, 5132 ... 5135, 5140:
An internal software error has occurred (only for internal Siemens troubleshooting).

5012: Error when initializing the PROFIsafe driver.

5013: The result of the initialization is different for the two controllers.

5022: Error when evaluating the F parameters. The values of the transferred F parameters do not match the expected values in the PROFIsafe driver.

5025: The result of the F parameterization is different for the two controllers.

5026: CRC error for the F parameters. The transferred CRC value of the F parameters does not match the value calculated in the PST.

5065: A communications error was identified when receiving the PROFIsafe telegram.

5066: A time monitoring error (timeout) was identified when receiving the PROFIsafe telegram.

6000 ... 6166:
PROFIsafe message values (PROFIsafe driver for PROFIBUS DP V1/V2 and PROFINET).
For these message values, the failsafe control signals (Failsafe Values) are transferred to the safety functions. If "SS1 after failure of PROFIsafe communication" is parameterized (p9612), then transfer of the Failsafe Values is delayed.
The significance of the individual message values is described in safety fault F01611.

7000: Difference of the safe position higher than the parameterized tolerance (p9542).

7002: Cycle counter for transferring the safe position is different in both monitoring channels.

See also: p9555 (SI Motion transition time F01711 to SS1), r9725 (SI Motion diagnostics A01711)

15.2 List of faults and alarms

Remedy:

For message value = 0:

- no error was identified in this monitoring channel. Observe the error message of the other monitoring channel (A30711).

For message value = 3:

Commissioning phase:

- check encoder parameters, and if required, correct (p9516, p9517, p9518, p9520, p9521, p9522, p9526).

In operation:

- check the mechanical design and the encoder signals.

For message value = 232:

- increase the hysteresis tolerance (p9547). Possibly set the filtering higher (p9545).

For message value = 278, 279, 280, 281: - check whether the same acceleration limit has been set for both channels. A different result depends on whether SLA is enabled and not selected - or enabled and selected. In this case, another message value is possible.

For message value = 1 ... 999:

- if the message value is listed under cause: Check the cross-checked parameters to which the message value refers.
- copy safety parameters and confirm the data change (commissioning tool).
- carry out a POWER ON (switch off/switch on) or a warm restart (p0009 = 30, p0976 = 2, 3).
- upgrade the drive software.
- correction of the encoder evaluation. The actual values differ as a result of mechanical faults (V belts, travel to a mechanical endstop, wear and window setting that is too narrow, encoder fault, ...).

For message value = 1001:

- carry out a POWER ON (switch off/switch on) or a warm restart (p0009 = 30, p0976 = 2, 3).
- upgrade the drive software.

For message value = 1005:

- check the conditions for deselecting STO.

For message value = 1007:

- check the PLC for the correct operating state (run state, basic program).

For message value = 1011:

- for diagnostics, refer to parameter (r9571).

For message value = 1012:

- upgrade the encoder evaluation firmware to a newer version.
- check encoder parameters to ensure that they are the same (p9515, p9519, p9523, p9524, p9525, p9529).
- start the copy function for encoder parameters (commissioning tool).
- the parameterized encoder does not correspond to the connected encoder - replace the encoder.
- check the electrical cabinet design and cable routing for EMC compliance
- carry out a POWER ON (switch off/switch on) or a warm restart (p0009 = 30, p0976 = 2, 3).
- replace the hardware.

For message value = 1020, 1021:

- check the communication link.
- carry out a POWER ON (switch off/switch on) or a warm restart (p0009 = 30, p0976 = 2, 3).
- replace the hardware.

For message value = 1035, if the safety encoder was replaced:

- acknowledge hardware replacement.
- save all parameters
- acknowledge fault.

For message value = 1039:

- check the conversion factors such as spindle pitch or gearbox ratios.

For message value = 5000, 5014, 5023, 5024, 5030, 5031, 5032, 5042, 5043, 5052, 5053, 5068, 5072, 5073, 5082 ... 5087, 5090, 5091, 5122 ... 5125, 5132 ... 5135, 5140:

- carry out a POWER ON (switch off/switch on) or a warm restart (p0009 = 30, p0976 = 2, 3).
- upgrade firmware to later version.
- contact Technical Support.
- replace drive.

For message value = 5012:

- check the setting of the PROFIsafe address of the drive (p9610). It is not permissible for the PROFIsafe address to be 0 or FFFF!

- copy safety parameters and confirm the data change (commissioning tool).

- carry out a POWER ON (switch off/switch on) or a warm restart (p0009 = 30, p0976 = 2, 3).

For message value = 5013, 5025:

- carry out a POWER ON (switch off/switch on) or a warm restart (p0009 = 30, p0976 = 2, 3).

- check the setting of the PROFIsafe address of the drive (p9610).

For message value = 5022:

- check the setting of the values of the F parameters at the PROFIsafe slave (F_SIL, F_CRC_Length, F_Par_Version, F_Source_Add, F_Dest_add, F_WD_Time).

For message value = 5026:

- check the settings of the values of the F parameters and the F parameter CRC (CRC1) calculated from these at the PROFIsafe slave and update.

For message value = 5065:

- check the configuration and communication at the PROFIsafe slave (cons. No. / CRC).

- check the setting of the value for F parameter F_WD_Time on the PROFIsafe slave and increase if necessary.

For message value = 5066:

- check the setting of the value for F parameter F_WD_Time on the PROFIsafe slave and increase if necessary.

- evaluate diagnostic information in the F host.

- check PROFIsafe connection.

For message value = 6000 ... 6999:

See the description of the message values for fault F01611.

Note:

SAM: Safe Acceleration Monitor (safe acceleration monitoring)

SBR: Safe Brake Ramp (safe ramp monitoring)

SDI: Safe Direction (safe motion direction)

SI: Safety Integrated

SLS: Safely-Limited Speed

SOS: Safe Operating Stop

SS1: Safe Stop 1

SS2: Safe Stop 2

SSM: Safe Speed Monitor (safety-relevant feedback signal from the speed monitoring)

A01714 SI Motion P1: Safely-Limited Speed exceeded

Reaction: NONE

Acknowledge: NONE

Cause: The drive has moved faster than that specified by the velocity limit value (p9531). The drive is stopped by the configured stop response (p9563).

Message value (r2124, interpret decimal):

100: SLS1 exceeded.

200: SLS2 exceeded.

300: SLS3 exceeded.

400: SLS4 exceeded.

1000: Encoder limit frequency exceeded.

Remedy: - check the traversing/motion program in the control.
- check limits for SLS and if required adapt accordingly (p9531).

Note:

SI: Safety Integrated

SLS: Safely-Limited Speed

See also: p9531 (SI Motion SLS limit values), p9563 (SI Motion SLS-specific stop response)

A01716 **SI Motion P1: Tolerance for safe motion direction exceeded**

Reaction: NONE

Acknowledge: NONE

Cause: The tolerance for the "safe motion direction" function was exceeded. The drive is stopped by the configured stop response (p9566).
Message value (r2124, interpret decimal):
0: Tolerance for function "safe motion direction positive" exceeded.
1: Tolerance for function "safe motion direction negative" exceeded.

Remedy: - check the traversing/motion program in the control.
- check the tolerance for "SDI" function and if required, adapt (p9564).
This message can be acknowledged as follows:
Deselect/select SDI and perform safe acknowledgment via PROFIsafe.
Note:
SDI: Safe Direction (safe motion direction)
SI: Safety Integrated
See also: p9564 (SI Motion SDI tolerance), p9565 (SI Motion SDI delay time), p9566 (SI Motion SDI stop response)

A01730 **SI Motion P1: Reference block for dynamic Safely-Limited Speed invalid**

Reaction: NONE

Acknowledge: NONE

Cause: The reference block transferred via PROFIsafe is negative.
A reference block is used to generate a referred velocity limit value based on the reference quantity "Velocity limit value SLS1" (p9531[0]).
The drive is stopped by the configured stop response (p9563[0]).
Message value (r2124, interpret decimal):
requested, invalid reference block.

Remedy: In the PROFIsafe telegram, input data S_SLS_LIMIT_IST must be corrected.
Note:
SI: Safety Integrated
SLS: Safely-Limited Speed

A01750 **SI Motion P1: Hardware fault safety-relevant encoder**

Reaction: NONE

Acknowledge: NONE

Cause: The encoder that is used for the safety-relevant motion monitoring functions signals a hardware fault.
Message value (r2124, interpret decimal):
Encoder status word 1, encoder status word 2 that resulted in the message.

Remedy: - check the encoder connection.
- replace encoder.

A01751 **SI Motion P1: Effectivity test fault safety-relevant encoder**

Reaction: NONE

Acknowledge: NONE

Cause: The DRIVE-CLiQ encoder for safe motion monitoring signals an error for the effectivity tests.
Message value (r2124, interpret decimal):
Only for internal Siemens troubleshooting.

Remedy: - check the encoder connection.
- replace encoder.
Note:
This message can be acknowledged via PROFIsafe (safe acknowledgment).

A01780 SBT When selected, the brake is closed

Reaction: NONE

Acknowledge: NONE

Cause: When selecting the brake test or starting the brake test, the brake was not open.

Alarm value (r2124, interpret binary):

Bit 0 = 1:

The internal brake is closed.

Note:

The alarm is also signaled if no brake is configured in p10202.

SBT: Safe Brake Test

See also: p10202 (SI Motion SBT brake)

Remedy: Open the brake and reselect the brake test.

A01781 SBT brake opening time exceeded

Reaction: NONE

Acknowledge: NONE

Cause: The maximum time (11 s) to open the brake during the brake test was exceeded.

Possible causes:

- during the brake test the drive went into a fault condition, and therefore the brake was closed by the drive.

Alarm value (r2124, interpret binary):

Bit 0 = 1:

Internal brake was not able to be opened.

Note:

SBT: Safe Brake Test

Remedy: - carry out a safe acknowledgment.

- restart the brake test.

A01782 SBT brake test incorrect control

Reaction: NONE

Acknowledge: NONE

Cause: The brake test was canceled as a result of incorrect control.

Alarm value (r2124, interpret binary):

Alarm value 0:

The brake test was canceled as a result of a fault (brake opening time or brake closing time exceeded).

Bit 0:

The safe brake test was canceled by resetting the brake test selection.

Bit 1:

The safe brake test was canceled by resetting the brake test start.

Bit 2:

The brake is not configured in configured p10202.

There is a brake test configuration error. In this case, alarm A01785 is also output.

Note:

SBT: Safe Brake Test

See also: p10202 (SI Motion SBT brake)

Remedy: - check parameterization of the brake test (p10202).

- check as to whether alarm A01785 is present, and if so, evaluate.

- carry out a safe acknowledgment.

- if required, restart the brake test.

A01783 SBT brake closing time exceeded

Reaction: NONE

Acknowledge: NONE

Cause: The maximum time (11 s) to close the brake during the brake test was exceeded.

Alarm value (r2124, interpret binary):

Bit 0 = 1:

The brake was not able to be closed.

Note:

SBT: Safe Brake Test

Remedy: - when using an internal brake with external feedback signal, check whether the feedback signal is correctly interconnected with the extended brake control.

- carry out a safe acknowledgment.

- restart the brake test.

A01784 SBT brake test canceled with fault

Reaction: NONE

Acknowledge: NONE

Cause: The safe brake test was canceled as a result of a fault.

Alarm value (r2124, interpret binary):

Bit 17 = 1: fault in the brake test sequence (cause, see bits 0 ... 10).

Bit 20 = 1: the brake is not opened (p10202).

Bit 21 = 1: axis position during the brake test not valid due to parking axis.

Bit 22 = 1: internal software error.

Bit 23 = 1: the permissible position range of the axis was violated with the brake closed (p10212/p10222).

Bit 24 = 1: the tested internal brake was opened while the brake test was active.

Bit 26 = 1: during the active brake test, the test torque left its tolerance bandwidth (20 %).

Cause for alarm value bit 17:

Bit 0 = 1: operation when selecting the brake test not enabled (r0899.2 = 0).

Bit 1 = 1: external fault occurred (e.g. the brake test that has already started is canceled by the user).

Bit 2 = 1: when selecting the brake test a brake is closed.

Bit 3 = 1: when determining the load torque a brake is closed.

Bit 4 = 1: A fault has occurred with stop response (e.g. OFF1, OFF2 or OFF3) - or the pulse enable was withdrawn (e.g. STO selected or operation no longer enabled).

Bit 5 = 1: when selecting the brake test the axis speed setpoint is too high.

Bit 6 = 1: the actual speed (r0063) of the axis is too high (e.g. brake does not hold during the brake test).

Bit 8 = 1: closed-loop control not enabled or function generator active.

Bit 9 = 1: control does not switch over to the brake test (e.g. because PI speed control has not been parameterized).

Bit 10 = 1: torque limit reached (r1407.7, r1408.8).

Note:

SBT: Safe Brake Test

Remedy: - remove the fault cause.

- carry out a safe acknowledgment.

- if required, restart the brake test.

For bit 17 = 1 with bit 6 = 1 or bit 23 = 1:

If the brake closing time of the motor holding brake (p1217) has been set too low, then at the start of the brake test, the brake is closed too late. The brake closing time should be adapted (p1217).

A01785 SBT brake test configuration error

Reaction: NONE

Acknowledge: NONE

Cause: Error when parameterizing the brake test.
 In this configuration, the brake test cannot be started or cannot be started without error.
 Alarm value (r2124, interpret decimal):
 1:
 No motion monitoring functions have been enabled.
 4:
 No brake was configured (p10202).
 8:
 The brake test is configured for an internal brake, however the safety brake control is not enabled (p9602).
 16:
 The safe brake test and safety without encoder are simultaneously enabled (p9506). This is not permissible.
 Note:
 SBT: Safe Brake Test

Remedy: Check parameterization of the brake test.

A01788 SI: Automatic test stop waits for STO deselection via motion monitoring functions

Reaction: NONE
Acknowledge: NONE
Cause: The automatic test stop (forced checking procedure) was not able to be carried out after powering up.
 Possible causes:
 - the STO function is selected via safe motion monitoring functions.
 - a safety message is present, that resulted in a STO.
 Note:
 STO: Safe Torque Off

Remedy: - deselect STO via safe motion monitoring functions.
 - remove the cause of the safety messages and acknowledge the messages.
 Note:
 The automatic test stop is performed after removing the cause.

A01796 SI P1: Wait for communication

Reaction: NONE
Acknowledge: NONE
Cause: The drive waits for communication to be established to execute the safety-relevant motion monitoring functions.
 Note:
 STO is active in this state.
 Alarm value (r2124, interpret decimal):
 3: Wait for communication to be established to PROFIsafe F-Host.

Remedy: If the message is not automatically withdrawn after a longer period of time, then carry out the following checks:
 - check any other PROFIsafe communication messages/signals present and evaluate them.
 - check the operating state of the F-Host.
 - check the communication connection to the F Host.
 Note:
 STO: Safe Torque Off
 See also: p9601 (SI enable, functions integrated in the drive)

A01798 SI Motion P1: Test stop for motion monitoring functions running

Reaction: NONE
Acknowledge: NONE
Cause: The forced checking procedure (test stop) for the safe motion monitoring functions is currently in progress.

15.2 List of faults and alarms

Remedy: Not necessary.
The message is automatically withdrawn when the test stop has been completed.
Note:
SI: Safety Integrated

A01799 SI Motion P1: Acceptance test mode active

Reaction: NONE
Acknowledge: NONE
Cause: The acceptance test mode is active.
This means that the setpoint speed limiting is deactivated (r9733).
Remedy: Not necessary.
The message is automatically withdrawn when exiting the acceptance test mode.
Note:
SI: Safety Integrated

F01800 DRIVE-CLiQ: Hardware/configuration error

Reaction: NONE
Acknowledge: IMMEDIATELY
Cause: A DRIVE-CLiQ connection fault has occurred.
Fault value (r0949, interpret decimal):
100 ... 107:
Communication via DRIVE-CLiQ socket X100 ... X107 has not been switched to cyclic operation. The cause may be an incorrect structure or a configuration that results in an impossible bus timing.
10:
Loss of the DRIVE-CLiQ connection. The cause may be, for example, that the DRIVE-CLiQ cable was withdrawn from the Control Unit or as a result of a short-circuit for motors with DRIVE-CLiQ. This fault can only be acknowledged in cyclic communication.
11:
Repeated faults when detecting the connection. This fault can only be acknowledged in cyclic communication.
12:
A connection was detected but the node ID exchange mechanism does not function. The reason is probably that the component is defective. This fault can only be acknowledged in cyclic communication.
Remedy: For fault value = 100 ... 107:
- ensure that the DRIVE-CLiQ components have the same firmware versions.
- avoid longer topologies for short current controller sampling times.
For fault value = 10:
- check the DRIVE-CLiQ cables at the Control Unit.
- remove any short-circuit for motors with DRIVE-CLiQ.
- carry out a POWER ON.
For fault value = 11:
- check the electrical cabinet design and cable routing for EMC compliance
For fault value = 12:
- replace the component involved.

A01839 DRIVE-CLiQ diagnostics: cable fault to the component

Reaction: NONE
Acknowledge: NONE

- Cause:** The fault counter (r9936[0...199]) to monitor the DRIVE-CLiQ connections/cables has been incremented.
 Alarm value (r2124, interpret decimal):
 Component number.
 Note:
 The component number specifies the component whose feeder cable from the direction of the Control Unit is faulted.
 The alarm is automatically withdrawn after 5 seconds, assuming that no other data transfer error has occurred.
- Remedy:** - check the corresponding DRIVE-CLiQ cables.
 - check the electrical cabinet design and cable routing for EMC compliance

A01900 PN: Configuration telegram error

Reaction: NONE

Acknowledge: NONE

- Cause:** A controller attempts to establish a connection using an incorrect configuring telegram.
 Alarm value (r2124, interpret decimal):
- 1:
 Connection established to more drive objects than configured in the device. The drive objects for process data exchange and their sequence are defined in p0978.
- 2:
 Too many PZD data words for output or input to a drive object. The number of possible PZD items in a drive object is determined by the number of indices in r2050/p2051.
- 3:
 Uneven number of bytes for input or output.
- 4:
 Setting data for synchronization not accepted. For more information, see A01902.
- 211:
 Unknown parameterizing block.
- 223:
 Clock synchronization for the PZD interface set in p8815[0] is not permissible.
 More than one PZD interface is operated in clock synchronism.
- 253:
 PN Shared Device: Illegal mixed configuration of PROFIsafe and PZD.
- 254:
 PN Shared Device: Illegal double assignment of a slot/subslot.
- 255:
 PN: Configured drive object and existing drive object do not match.
- 256:
 PN: configured telegram cannot be set.
- 500:
 Illegal PROFIsafe configuration for the interface set in p8815[1].
 More than one PZD interface is operated with PROFIsafe.
- 501:
 PROFIsafe parameter error (e.g. F_dest).
- 502:
 PROFIsafe telegram does not match.
- 503:
 PROFIsafe connection is rejected as long as there is no isochronous connection (p8969).
- Additional values:
 Only for internal Siemens troubleshooting.

15.2 List of faults and alarms

Remedy: Check the bus configuration on the master and the slave sides.
For alarm value = 1, 2:
- check the list of the drive objects with process data exchange (p0978).
Note:
With p0978[x] = 0, all of the following drive objects in the list are excluded from the process data exchange.
For alarm value = 2:
- check the number of data words for output and input to a drive object.
For alarm value = 211:
- Ensure offline version <= online version.
For alarm value = 223, 500:
- check the setting in p8839 and p8815.
- check for inserted but not configured CBE20.
- ensure that only one PZD interface is operated in clock synchronism or with PROFIsafe.
For alarm value = 255:
- check configured drive objects.
For alarm value = 256:
- check the configured telegram.
For alarm value = 501:
- check the set PROFIsafe address (p9610).
For alarm value = 502:
- check the set PROFIsafe telegram (p60022, p9611).

A01902 PN: clock cycle synchronous operation parameterization not permissible

Reaction: NONE

Acknowledge: NONE

Cause: Parameterization for isochronous operation is not permissible.
Alarm value (r2124, interpret decimal):
0: Bus cycle time Tdp < 0.5 ms.
1: Bus cycle time Tdp > 32 ms.
2: Bus cycle time Tdp is not an integer multiple of the current controller sampling time.
3: Instant of the actual value sensing Ti > Bus cycle time Tdp or Ti = 0.
4: Instant of the actual value sensing Ti is not an integer multiple of the current controller sampling time.
5: Instant of the setpoint acceptance To >= Bus cycle time Tdp or To = 0.
6: Instant of the setpoint acceptance To is not an integer multiple of the current controller sampling time.
7: Master application cycle time Tmapc is not an integer multiple of the speed controller sampling time.
8: Bus reserve bus cycle time Tdp - data exchange time Tdx less than two current controller sampling times.
10: Instant of the setpoint acceptance To <= data exchange time Tdx + current controller sampling time
11: Master application cycle time Tmapc > 14 x Tdp or Tmapc = 0.
12: PLL tolerance window Tpll_w > Tpll_w_max.
13: Bus cycle time Tdp is not a multiple of all basic clock cycles p0110[x].
16: For COMM BOARD, the instant in time for the actual value sensing Ti is less than two current controller sampling times.

Remedy: - adapt the bus parameterization Tdp, Ti, To.
- adapt the sampling time for the current controller or speed controller.
For alarm value = 10:
- reduce Tdx by using fewer bus participants or shorter telegrams.
Note:
PN: PROFINET

F01910 Fieldbus: setpoint timeout

Reaction: OFF3

Acknowledge: IMMEDIATELY

Cause: The reception of setpoints from the fieldbus interface (onboard, PROFIBUS/PROFINET/USS) has been interrupted.
 - bus connection interrupted.
 - controller switched off.
 - controller set into the STOP state.

Remedy: Restore the bus connection and set the controller to RUN.
 Note regarding PROFIBUS slave redundancy:
 For operation on a Y link, it must be ensured that "DP alarm mode = DPV1" is set in the slave parameterization.

F01911 PN: Clock synchronous operation, clock cycle failure

Reaction: OFF1

Acknowledge: IMMEDIATELY

Cause: The global control telegram to synchronize the clock cycles has failed - in cyclic operation - for several DP clock cycles or has violated the time grid specified in the parameterizing telegram over several consecutive DP clock cycles (refer to the bus cycle time, Tdp and Tplw).

Remedy:
 - check the physical bus configuration (cable, connector, terminating resistor, shielding, etc.).
 - check whether communication was briefly or permanently interrupted.
 - check the utilization level of the bus and controller (e.g. bus cycle time Tdp was set too short).

Note:
 PN: PROFINET

F01912 PN: Clock synchronous operation sign-of-life missing

Reaction: OFF1

Acknowledge: IMMEDIATELY

Cause: The maximum permissible number of errors in the controller sign-of-life (clock synchronous operation) has been exceeded in cyclic operation.

Remedy:
 - physically check the bus (cables, connectors, terminating resistor, shielding, etc.).
 - correct the interconnection of the controller sign-of-life (p2045).
 - check whether the controller correctly sends the sign-of-life (e.g. create a trace with STW2.12 ... STW2.15 and trigger signal ZSW1.3).
 - check the permissible telegram failure rate (p0925).
 - check the utilization level of the bus and controller (e.g. bus cycle time Tdp was set too short).

Note:
 PN: PROFINET

A01932 PN: clock cycle synchronization missing for DSC

Reaction: NONE

Acknowledge: NONE

Cause: There is no clock synchronization or clock synchronous sign of life and DSC is selected.
 Note:
 DSC: Dynamic Servo Control
 See also: r0922 (PROFIdrive PZD telegram selection)

Remedy: Set clock synchronization across the bus configuration and transfer clock synchronous sign-of-life.

A01940 PN: Clock cycle synchronism not reached

Reaction: NONE

Acknowledge: NONE

15.2 List of faults and alarms

Cause: The bus is in the data exchange state and clock synchronous operation has been selected using the parameterizing telegram. It was not possible to synchronize to the clock cycle specified by the master.

- the master does not send a clock synchronous global control telegram although clock synchronous operation was selected when configuring the bus.
- the master is using an isochronous DP clock cycle that is different than was transferred to the slave in the parameterizing telegram.
- at least one drive object has a pulse enable (also not controlled from PROFINET).

Remedy:

- check the master application and bus configuration.
- check the consistency between the clock cycle input when configuring the slave and clock cycle setting at the master.
- check that no drive object has a pulse enable. Only enable the pulses after synchronizing the PROFINET drives.

Note:
PN: PROFINET

A01941 PN: Clock cycle signal missing when the bus is being established

Reaction: NONE
Acknowledge: NONE
Cause: The bus is in the data exchange state and clock synchronous operation has been selected using the parameterizing telegram. The global control telegram for synchronization is not being received.
Remedy: Check the master application and bus configuration.
Note:
PN: PROFINET

A01943 PN: Clock cycle signal error when the bus is being established

Reaction: NONE
Acknowledge: NONE
Cause: The bus is in the data exchange state and clock synchronous operation has been selected using the parameterizing telegram. The global control telegram for synchronization is being irregularly received.

- the master is sending an irregular global control telegram.
- the master is using another clock synchronous DP clock cycle than was transferred to the slave in the parameterizing telegram.

Remedy:

- check the master application and bus configuration.
- check the consistency between the clock cycle input when configuring the slave and clock cycle setting at the master.

Note:
PN: PROFINET

A01944 PN: Sign-of-life synchronism not reached

Reaction: NONE
Acknowledge: NONE
Cause: The bus is in the data exchange state and clock synchronous operation has been selected using the parameterizing telegram. Synchronization with the master sign-of-life (STW2.12 ... STW2.15) could not be completed because the sign-of-life is changing differently to how it was configured in the Tmapc time grid.
Remedy:

- ensure that the master correctly increments the sign-of-life in the master application clock cycle Tmapc.
- correct the interconnection of the master sign-of-life (p2045).

Note:
PN: PROFINET

F01950 PN: Clock synchronous operation, synchronization unsuccessful

Reaction: OFF1
Acknowledge: IMMEDIATELY

Cause: Synchronization of the internal clock cycle to the global control telegram has failed. The internal clock cycle exhibits an unexpected shift.

Remedy: Only for internal Siemens troubleshooting.
Note:
PN: PROFINET

A01980 PN: cyclic connection interrupted

Reaction: NONE

Acknowledge: NONE

Cause: The cyclic connection to the PROFINET controller is interrupted.
See also: r8936 (Cyclic connection status)

Remedy: Establish the PROFINET connection and activate the PROFINET controller in the cyclic mode.

A01981 PN: Maximum number of controllers exceeded

Reaction: NONE

Acknowledge: NONE

Cause: A controller attempts to establish a connection to the drive, and as a consequence exceeds the permitted number of PROFINET connections.
The alarm is automatically withdrawn after approx. 30 seconds.
Alarm value (r2124, interpret hexadecimal):
yyyyxxx hex: yyyy = info. 1, xxx = info. 2
Info 1 = 0: number of RT connections exceeded
Info 1 > 0: number of IRT connections exceeded
Info 2: permitted number of connections

Remedy: Check the configuration of the PROFINET controllers.

A01989 PN: internal cyclic data transfer error

Reaction: NONE

Acknowledge: NONE

Cause: The cyclic actual values and/or setpoints were not transferred within the specified times.
Alarm value (r2124, interpret hexadecimal):
Only for internal Siemens troubleshooting.

Remedy: Correctly set T_io_input or T_io_output.

A02007 Function generator: Drive not SERVO / VECTOR / DC_CTRL

Reaction: NONE

Acknowledge: NONE

Cause: The drive object specified for connection is not a SERVO / VECTOR or DC_CTRL.

Remedy: Use a SERVO / VECTOR / DC_CTRL drive object with the corresponding number.
Note:
The alarm is reset as follows:
- remove the cause of this alarm.
- restart the function generator.

F03001 NVRAM checksum incorrect

Reaction: NONE

Acknowledge: IMMEDIATELY

Cause: A checksum error occurred when evaluating the non-volatile data (NVRAM) on the Control Unit.
The NVRAM data affected was deleted.

Remedy: Carry out a POWER ON (switch-off/switch-on) for all components.

A05000	Power unit: Overtemperature heat sink AC inverter
Reaction:	NONE
Acknowledge:	NONE
Cause:	The alarm threshold for overtemperature at the inverter heat sink has been reached. The response is set using p0290. If the heat sink temperature exceeds the value set in p0292[0], then fault F30004 is output.
Remedy:	Check the following: <ul style="list-style-type: none">- is the ambient temperature within the defined limit values?- have the load conditions and the load duty cycle been appropriately dimensioned?- has the cooling failed?

A05001	Power unit: Overtemperature depletion layer chip
Reaction:	NONE
Acknowledge:	NONE
Cause:	Alarm threshold for overtemperature of the power semiconductor in the AC converter has been reached.
	Note: <ul style="list-style-type: none">- the response is set using p0290.- if the temperature of the barrier layer increases by the value set in p0292[1], then fault F30025 is initiated.
Remedy:	Check the following: <ul style="list-style-type: none">- is the ambient temperature within the defined limit values?- have the load conditions and the load duty cycle been appropriately dimensioned?- has the cooling failed?- pulse frequency too high? See also: r0037 (Drive temperatures)

A05003	Power unit: Internal overtemperature
Reaction:	NONE
Acknowledge:	NONE
Cause:	The alarm threshold for internal overtemperature has been reached. If the temperature inside the power unit increases by an additional 5 K, then fault F30036 is triggered.
Remedy:	Check the following: <ul style="list-style-type: none">- is the ambient temperature within the defined limit values?- has the fan failed? Check the direction of rotation.

A05006	Power unit: Overtemperature thermal model
Reaction:	NONE
Acknowledge:	NONE
Cause:	The temperature difference between the chip and heat sink has exceeded the permissible limit value (blocksize power units only). Depending on p0290, an appropriate overload response is initiated. See also: r0037 (Drive temperatures)
Remedy:	Not necessary. This alarm is automatically withdrawn once the limit value has been fallen below. Note: If the alarm is not automatically withdrawn and the temperature continues to rise, this can result in fault F30024.

F06310	Supply voltage (p0210) incorrectly parameterized
Reaction:	NONE
Acknowledge:	IMMEDIATELY

Cause: For AC/AC drive units, the measured DC voltage lies outside the tolerance range after precharging has been completed. The following applies for the tolerance range: $1.16 * p0210 < r0070 < 1.6 * p0210$
 Note:
 The fault can only be acknowledged when the drive is switched off.
 See also: p0210 (Drive unit line supply voltage)

Remedy: - check the parameterized supply voltage and if required change (p0210).
 - check the line supply voltage.
 See also: p0210 (Drive unit line supply voltage)

F07011 Drive: Motor overtemperature

Reaction: OFF2

Acknowledge: IMMEDIATELY

Cause: The calculated motor temperature is too high.

Possible causes:

- motor overloaded.
- motor ambient temperature too high.
- sensor wire breakage

Fault value (r0949, interpret decimal):

200:

Motor temperature model 1 (I2t): temperature too high.

300:

Motor temperature model 3: after the monitoring time has expired, the temperature is still higher than the alarm threshold.

301:

Motor temperature model 3: temperature is too high, or the model has not been parameterized.

302:

Motor temperature model 3: Encoder temperature is not within the valid range.

Remedy: - reduce the motor load.
 - check the ambient temperature and the motor ventilation.
 - check the wiring and temperature sensor connection.
 - check monitoring limits.

A07012 Drive: Motor temperature model 1/3 overtemperature

Reaction: NONE

Acknowledge: NONE

Cause: The motor temperature model 1/3 identified that the alarm threshold was exceeded.

Hysteresis:2K

Alarm value (r2124, interpret decimal):

200:

Motor temperature model 1 (I2t): temperature too high.

300:

Motor temperature model 3: temperature too high.

See also: r0034 (Motor utilization thermal), p0613 (Motor temperature model ambient temperature)

Remedy: - check the motor load and if required, reduce.
 - check the motor ambient temperature.
 See also: r0034 (Motor utilization thermal)

F07085 Drive: Open-loop/closed-loop control parameters changed

Reaction: NONE

Acknowledge: IMMEDIATELY

15.2 List of faults and alarms

Cause: Open-loop/closed-loop control parameters have had to be changed.
Possible causes:
1. As a result of other parameters, they have exceeded the dynamic limits.
2. They cannot be used due to the fact that the hardware detected not having certain features.
3. The value is estimated as the thermal time constant is missing.
4. Motor temperature model 1 is activated as thermal motor protection is missing.
See also: p1082 (Maximum speed)

Remedy: Not necessary.
It is not necessary to change the parameters as they have already been correctly limited.

A07091 Drive: determined current controller dynamic response invalid

Reaction: NONE

Acknowledge: NONE

Cause: When one button tuning is activated (p5300 = 1), the current controller is measured after the pulses have been enabled. Evaluation has indicated that the current control loop was not appropriately set.
Possible causes:
- incorrectly set current controller.
- PRBS amplitude set too high (p5296).
Alarm value (r2124, interpret hexadecimal):
1: Dynamic response too low.
2: Current controller unstable.
Note:
PRBS: Pseudo Random Binary Signal (binary noise)

Remedy: - the measurement can be repeated with a smaller excitation amplitude (p5296).
- if required, adapt the current controller proportional gain (p1715).

A07092 Drive: moment of inertia estimator still not ready

Reaction: NONE

Acknowledge: NONE

Cause: The moment of inertia estimator has still not determined any valid values.
The acceleration cannot be calculated.
The moment of inertia estimator has stabilized, if the frictional values (p1563, p1564) as well as the moment of inertia value (p1493) have been determined and the appropriate status signal is set (r1407.26 = 1).
The following parameters influence the response of the moment of the inertia estimator:
p1560, p1561, p1562

Remedy: Traverse the axis until the moment of inertia estimator has stabilized.
This alarm is automatically withdrawn after the moment of inertia estimator has stabilized.

F07093 Drive: Test signal error

Reaction: OFF3

Acknowledge: IMMEDIATELY

Cause:	<p>An error was identified when executing the "Test signal" function (p5307.1 = 1). The function was not executed or was canceled. Fault value (r0949, interpret decimal):</p> <ol style="list-style-type: none"> 1: No distance limit has been defined (p5308 = 0). 2: The moment of inertia estimator has not stabilized in the parameterized time (p5309) (r1407.26). 3: The parameterized distance (p5308) was exceeded. 4: no motor encoder parameterized (closed-loop speed control without encoder). 5: Offset (p5297) is too high for the parameterized distance (p5308). 6: Pulse enable was withdrawn while traversing. 7: speed setpoint not equal to zero. <p>See also: p5308 (One Button Tuning distance limiting), p5309 (One Button Tuning duration)</p>
Remedy:	<p>For fault value = 1: - Define distance limiting (p5308).</p> <p>For fault value = 2: - increase the duration or distance limiting (p5309, p5308).</p> <p>For fault value = 3: - check distance limiting (p5308).</p> <p>For fault value = 4: - configure speed control with encoder.</p> <p>For fault value = 5: - increase distance limit p5308 or reduce offset p5297. - the fault can only be acknowledged after p5300 was set = 0. - for the factory setting, a test signal duration of approximately 1.3 s is obtained. If an offset (p5297) of 60 rpm is set, for example, then this results in a distance of approximately 1.3 revolutions. As a consequence, a value must be parameterized in parameter p5308, which is longer than this distance + 10% controller reserve (e.g. p5308=515°). Further, the distance depends on the speed controller sampling time (p0115[1]) and the controller configuration (p5271).</p> <p>For fault value = 6: - keep the drive switched on until the "Test signal" function has been completely exited.</p> <p>For fault value = 7: - set the speed setpoint to zero. It is possible that the setpoint was entered from the control panel.</p>

A07094 General parameter limit violation

Reaction:	NONE
Acknowledge:	NONE
Cause:	<p>As a result of the violation of a parameter limit, the parameter value was automatically corrected. Minimum limit violated --> parameter is set to the minimum value. Maximum limit violated --> parameter is set to the maximum value. Alarm value (r2124, interpret decimal): Parameter number, whose value had to be adapted.</p>
Remedy:	Check the adapted parameter values and if required correct.

A07095 Drive: One Button Tuning activated

Reaction:	NONE
Acknowledge:	NONE
Cause:	<p>The One Button Tuning function is active. One Button Tuning is performed at the next switch-on command. See also: p5300 (One Button Tuning selection)</p>
Remedy:	<p>Not necessary. The alarm is automatically withdrawn after One Button Tuning has been exited (p5300 = 0).</p>

F07097 **Drive: Test signal error distance limiting**

Reaction: OFF3

Acknowledge: IMMEDIATELY

Cause: An error was identified when executing the "Test signal" function (p5307.1 = 1) or auto tuning was selected (p5300 = 1). The function was not executed or was canceled.
Fault value (r0949, interpret decimal):
yyyyxxxx hex: yyyy = error cause, xxxx = traversing distance
Fault cause = 4:
- travel distance to the EPOS software limit switch is not sufficient.
See also: p5308 (One Button Tuning distance limiting), p5309 (One Button Tuning duration)

Remedy: - enter the traversing path in parameter p5308 - or deselect the function involved in p5301.
- for fault cause = 1, 2, shorter traversing paths may be possible.
For fault cause = 1:
- deselect bit 0 and bit 1 in parameter p5301.
For fault cause = 2:
- deselect bit 2 in parameter p5301.
For fault cause = 3:
- deselect bit 4 and bit 5 in parameter p5301.
For fault cause = 4:
- change the travel direction of One Button Tuning via p5308.
- increase the clearance to the EPOS software limit switch by manually traversing.

A07200 **Drive: Master control ON command present**

Reaction: NONE

Acknowledge: NONE

Cause: The ON/OFF1 command is present (no 0 signal).
The command is either influenced via binector input p0840 (current CDS) or control word bit 0 via the master control.

Remedy: Switch the signal via binector input p0840 (current CDS) or control word bit 0 via the master control to 0.

F07220 **Drive: Master control by PLC missing**

Reaction: OFF1

Acknowledge: IMMEDIATELY

Cause: The "master control by PLC" signal was missing in operation.
- interconnection of the binector input for "master control by PLC" is incorrect (p0854).
- the higher-level control has withdrawn the "master control by PLC" signal.
- data transfer via the fieldbus (master/drive) was interrupted.

Remedy: - check the interconnection of the binector input for "master control by PLC" (p0854).
- check the "master control by PLC" signal and, if required, switch in.
- check the data transfer via the fieldbus (master/drive).

Note:
If the drive should continue to operate after withdrawing "master control by PLC" then fault response must be parameterized to NONE or the message type should be parameterized as alarm.

F07410 **Drive: Current controller output limited**

Reaction: OFF2

Acknowledge: IMMEDIATELY

Cause: The condition "I_act = 0 and Uq_set_1 longer than 16 ms at its limit" is present and can be caused by the following:
- motor not connected or motor contactor open.
- no DC link voltage present.
- Motor Module defective.

- Remedy:**
- connect the motor or check the motor contactor.
 - check the DC link voltage (r0070).
 - check the Motor Module.

F07412 Drive: Commutation angle incorrect (motor model)

Reaction: ENCODER

Acknowledge: IMMEDIATELY

Cause: An incorrect commutation angle was detected that can result in a positive coupling in the speed controller.

Possible causes:

- the phase sequence of the output phases for the motor is incorrect (e.g. the phases are interchanged).
- the motor encoder is incorrectly adjusted with respect to the magnet position.
- the motor encoder is damaged.
- the angular commutation offset is incorrectly set (p0431).
- data to calculate the motor model has been incorrectly set (p0356 (motor-stator leakage inductance) and/or p0350 (motor-stator resistance) and/or p0352 (cable resistance)).
- the changeover speed for the motor model is too low (p1752). The monitoring function only becomes effective above the changeover speed.
- pole position identification might have calculated an incorrect value when activated (p1982 = 1).
- the motor encoder speed signal is faulted.
- the control loop is instable due to incorrect parameterization.

Fault value (r0949, interpret decimal):

SERVO:

0: The comparison of the pole position angle from the encoder and motor model resulted in an excessively high value (> 80 ° electrical).

1: -

VECTOR:

0: The comparison of the pole position angle from the encoder and motor model resulted in an excessively high value (> 45 ° electrical).

1: The change in the speed signal from the motor encoder has changed by > p0492 within a current controller clock cycle.

- Remedy:**
- check the phase sequence for the motor, and if required, correct (wiring, p1820).
 - if the encoder mounting was changed - re-adjust the encoder.
 - replace the defective motor encoder.
 - correctly set the angular commutation offset (p0431). If required, determine using p1990.
 - correctly set the motor stator resistance, cable resistance and motor-stator leakage inductance (p0350, p0352, p0356). Calculate the cable resistance from the cross-section and length, check the inductance and stator resistance using the motor data sheet, measure the stator resistance, e.g. using a multimeter - and if required, again identify the values using the stationary motor data identification (p1910).
 - increase the changeover speed for the motor model (p1752). The monitoring is completely deactivated for p1752 > p1082 (maximum speed).
 - with pole position identification activated (p1982 = 1) check the procedure for pole position identification (p1980) and force a new pole position identification procedure by means of deselection followed by selection (p1982 = 0 -> 1).

Note:

For High Dynamic Motors (1FK7xxx-7xxx), for applications with a higher current, if necessary, the monitoring should be disabled.

F07414 Drive: Encoder serial number changed

Reaction: ENCODER

Acknowledge: IMMEDIATELY

15.2 List of faults and alarms

Cause: The serial number of the motor encoder of a synchronous motor has changed. The change was only checked for encoders with serial number (e.g. EnDat encoders) and built-in motors (e.g. p0300 = 401) or third-party motors (p0300 = 2).

Cause 1:
- the encoder was replaced.

Cause 2:
- a third-party, built-in or linear motor was re-commissioned.

Cause 3:
- the motor with integrated and adjusted encoder was replaced.

Cause 4:
- the firmware was updated to a version that checks the encoder serial number.

Note:
With closed-loop position control, the serial number is accepted when starting the adjustment (p2507 = 2).
When the encoder is adjusted (p2507 = 3), the serial number is checked for changes and if required, the adjustment is reset (p2507 = 1).

Proceed as follows to hide serial number monitoring:
- set the following serial numbers for the corresponding Encoder Data Set: p0441= FF, p0442 = 0, p0443 = 0, p0444 = 0, p0445 = 0.
- parameterize F07414 as message type N (p2118, p2119).

Remedy: For causes 1, 2:
Carry out an automatic adjustment using the pole position identification routine. Acknowledge fault. Initiate the pole position identification routine with p1990 = 1. Then check that the pole position identification routine is correctly executed.
SERVO:
If a pole position identification technique is selected in p1980, and if p0301 does not contain a motor type with an encoder adjusted in the factory, then p1990 is automatically activated.
or
Set the adjustment via p0431. In this case, the new serial number is automatically accepted.
or
Mechanically adjust the encoder. Accept the new serial number with p0440 = 1.
For causes 3, 4:
Accept the new serial number with p0440 = 1.

F07433 **Drive: Closed-loop control with encoder is not possible as the encoder has not been unparked**

Reaction: NONE

Acknowledge: IMMEDIATELY

Cause: The changeover to closed-loop control with encoder is not possible as the encoder has not been unparked.

Remedy: - check whether the encoder firmware supports the "parking" function (r0481.6 = 1).
- upgrade the firmware.

Note:
For long-stator motors (p3870.0 = 1), the following applies:
The encoder must have completed the unparking procedure (r3875.0 = 1) before a changeover can be made to closed-loop control with encoder. The encoder is unparked using binector input p3876 = 0/1 signal and remains until a 0 signal in this state.

F07434 **Drive: It is not possible to change the direction of rotation with the pulses enabled**

Reaction: OFF2

Acknowledge: IMMEDIATELY

Cause: A drive data set was selected - with the pulses enabled - which has a different parameterized direction of rotation (p1821). It is only possible to change the motor direction of rotation using p1821 when the pulses are inhibited.

Remedy: - change over the drive data set with the pulses inhibited.
- ensure that the changeover to a drive data set does not result in the motor direction of rotation being changed (i.e. for these drive data sets, the same value must be in p1821).
See also: p1821 (Direction of rotation)

A07565	Drive: Encoder error in PROFIdrive encoder interface 1
Reaction:	NONE
Acknowledge:	NONE
Cause:	An encoder error was signaled for encoder 1 via the PROFIdrive encoder interface (G1_ZSW.15). Alarm value (r2124, interpret decimal): Error code from G1_XIST2.
Remedy:	Acknowledge the encoder error using the encoder control word (G1_STW.15 = 1).

F07575	Drive: Motor encoder not ready
Reaction:	OFF2
Acknowledge:	IMMEDIATELY
Cause:	The motor encoder signals that it is not ready. - initialization of encoder 1 (motor encoder) was unsuccessful. - the function "parking encoder" is active (encoder control word G1_STW.14 = 1). - the encoder interface (Sensor Module) is deactivated (p0145). - the Sensor Module is defective.
Remedy:	Evaluate other queued faults via encoder 1.

F07801	Drive: Motor overcurrent
Reaction:	OFF2
Acknowledge:	IMMEDIATELY
Cause:	The permissible motor limit current was exceeded. - active current limit too low. - current controller not correctly set. - load is too high. - short-circuit in the motor cable or ground fault. - motor current does not match the drive current.
Remedy:	- reduce the load. - check the motor and motor cables for short-circuit and ground fault. - check the drive and motor combination.

F07802	Drive: Infeed not ready
Reaction:	OFF2
Acknowledge:	IMMEDIATELY
Cause:	The drive does not signal a ready state after an internal switch-on command. - DC link voltage is not present. - defective drive. - supply voltage incorrectly set.
Remedy:	- check the enable signals for the drive. - replace the drive. - check the line supply voltage setting (p0210).

A07805	Drive: Power unit overload I2t
Reaction:	NONE
Acknowledge:	NONE
Cause:	The alarm threshold for I2t overload (p0294) of the power unit has been exceeded. The response parameterized in p0290 becomes active.

15.2 List of faults and alarms

Remedy:

- reduce the continuous load.
- adapt the load duty cycle.
- check the assignment of the rated currents of the motor and Motor Module.

F07860 External fault

Reaction: OFF2
Acknowledge: IMMEDIATELY
Cause: The condition for "External fault" is present.
Remedy:

- eliminate the causes of this fault.
- acknowledge fault.

F07900 Drive: Motor blocked/speed controller at its limit

Reaction: OFF2
Acknowledge: IMMEDIATELY
Cause: The motor operates longer than 0.2 seconds at the torque limit and below the speed threshold in p2175.
This signal can also be initiated if the speed actual value is oscillating and the speed controller output repeatedly goes to its limit.
See also: p2175 (Motor blocked speed threshold)
Remedy:

- check that the motor can freely move.
- check the effective torque limit (r1538, r1539).
- check the parameter of the "Motor blocked" signal and possibly correct (p2175).

F07901 Drive: Motor overspeed

Reaction: OFF2
Acknowledge: IMMEDIATELY
Cause: The maximum permissible speed was either positively or negatively exceeded (p1082).
Remedy:

- check the speed controller.
- check the maximum speed (p1082).

F07930 Drive: Brake control error

Reaction: OFF1
Acknowledge: IMMEDIATELY

Cause:	<p>The "Safety Integrated" function integrated in the drive has identified a brake control fault in monitoring channel 2, and has initiated STO.</p> <ul style="list-style-type: none"> - OCC cable shield is not correctly connected. - defect in the brake control circuit of the drive. <p>Fault value (r0949, interpret decimal):</p> <p>10, 11: Fault in "open holding brake" operation.</p> <ul style="list-style-type: none"> - brake not closed or interrupted cable. - ground fault in brake cable. <p>20: Fault in "brake open" state.</p> <ul style="list-style-type: none"> - short-circuit in brake winding. <p>30, 31: Fault in "close holding brake" operation.</p> <ul style="list-style-type: none"> - brake not closed or interrupted cable. - short-circuit in brake winding. <p>40: Fault in "brake closed" state.</p> <p>50: Fault in the brake control of the drive or a communication error (brake control diagnostics).</p>
Remedy:	<ul style="list-style-type: none"> - select STO and then deselect again. - check the motor holding brake connection. - check the function of the motor holding brake. - carry out a diagnostics routine for the faults involved. - check for EMC-compliant control cabinet design and cable routing (e.g. shield OCC cable with shield terminal and shield plate, check the connection of the brake conductors). - replace drive. <p>Note:</p> <p>OCC: One Cable Connection (one cable system) SBC: Safe Brake Control SI: Safety Integrated STO: Safe Torque Off</p> <p>See also: p1215 (Motor holding brake configuration)</p>

F07935 Drive: Incorrect motor holding brake configuration

Reaction: NONE

Acknowledge: IMMEDIATELY

Cause: An incorrect motor holding brake configuration was detected.

Fault value (r0949, interpret decimal):

0:

A motor holding brake was detected where the brake control has not been configured (p1215 = 0).

The brake control configuration was set to "motor holding brake the same as sequence control" (p1215 = 1) (only when commissioning for the first time).

1:

A motor holding brake was detected where the brake control has not been configured (p1215 = 0).

The brake control configuration was left at "No motor holding brake available" (p1215 = 0).

15.2 List of faults and alarms

Remedy: For fault value = 0:
- no remedy required.
For fault value = 1:
- if required change the motor holding brake configuration (p1215 = 1, 2).
- if this fault value unexpectedly occurs, then the motor connections should be checked in order to rule out that they have been interchanged.
See also: p1215 (Motor holding brake configuration)

F07955 Drive: Motor has been changed

Reaction: NONE
Acknowledge: IMMEDIATELY
Cause: The code number of the actual motor with DRIVE-CLiQ does not match the saved number. If available: The code numbers of the bearings, gearbox or brake do not match the saved numbers.
Remedy: Connect the original motor, and switch on the Control Unit again (POWER ON) - or restore the factory settings. The data for bearings, gearbox and brake are reloaded.

F08501 PN/COMM BOARD: Setpoint timeout

Reaction: OFF3
Acknowledge: IMMEDIATELY
Cause: The reception of setpoints from the COMM BOARD has been interrupted.
- bus connection interrupted.
- controller switched off.
- controller set into the STOP state.
- COMM BOARD defective.
Remedy: - Restore the bus connection and set the controller to RUN.
- if the error is repeated, check the update time set in the bus configuration (HW Config).

A08511 PN/COMM BOARD: Receive configuration data invalid

Reaction: NONE
Acknowledge: NONE
Cause: The drive unit did not accept the receive configuration data.
Alarm value (r2124, interpret decimal):
Return value of the receive configuration data check.
1: Connection established to more drive objects than configured in the device. The drive objects for process data exchange and their sequence are defined in p0978.
2: Too many PZD data words for output or input to a drive object. The number of possible PZD items in a drive object is determined by the number of indices in r2050/p2051 for PZD IF1, and in r8850/p8851 for PZD IF2.
3: Uneven number of bytes for input or output.
4: Setting data for synchronization not accepted. For more information, see A01902.
5: Cyclic operation not active.
17: CBE20 Shared Device: Configuration of the F-CPU has been changed.
223: Illegal clock synchronization for the PZD interface set in p8815[0].
500: Illegal PROFIsafe configuration for the interface set in p8815[1].
501: PROFIsafe parameter error (e.g. F_dest).
503: PROFIsafe connection is rejected as long as there is no isochronous connection (p8969).
Additional values:
Only for internal Siemens troubleshooting.

Remedy: Check the receive configuration data.
 For alarm value = 1, 2:
 - check the list of the drive objects with process data exchange (p0978). With p0978[x] = 0, all of the following drive objects in the list are excluded from the process data exchange.
 For alarm value = 2:
 - check the number of data words for output and input to a drive object.
 For alarm value = 17:
 - CBE20 Shared Device: Unplug/plug A-CPU.
 For alarm value = 223, 500:
 - check the setting in p8839 and p8815.
 - ensure that only one PZD interface is operated in clock synchronism or with PROFIsafe.
 For alarm value = 501:
 - check the set PROFIsafe address (p9610).

A08800 PROFenergy energy-saving mode active

Reaction: NONE

Acknowledge: NONE

Cause: The PROFenergy energy-saving mode is active
 Alarm value (r2124, interpret decimal):
 Mode ID of the active PROFenergy energy-saving mode.
 See also: r5600 (Pe energy-saving mode ID)

Remedy: The alarm is automatically withdrawn when the energy-saving mode is exited.
 Note:
 The energy-saving mode is exited after the following events:
 - the PROFenergy command end_pause is received from the higher-level control.
 - the higher-level control has changed into the STOP operating state.
 - the PROFINET connection to the higher-level control has been disconnected.

A09000 Web server user incorrectly configured

Reaction: NONE

Acknowledge: NONE

Cause: An error occurred when configuring the web server user.
 Fault value (r0949, interpret decimal):
 0: No admin password
 1: Invalid admin password
 2: Invalid SINAMICS password

Remedy: Correct the user configuration, enter a correct password.

F13000 License not adequate

Reaction: OFF2

Acknowledge: IMMEDIATELY

15.2 List of faults and alarms

Cause:

- for the drive unit, the options that require a license are being used but the licenses are not sufficient.
- an error occurred when checking the existing licenses.

Fault value (r0949, decimal interpretation):

0:
The existing license is not sufficient.

1:
An adequate license was not able to be determined as the memory card with the required licensing data was withdrawn in operation.

2:
An adequate license was not able to be determined as there is no licensing data available on the memory card.

3:
An adequate license was not able to be determined as there is a checksum error in the license key.

4:
An internal error occurred when checking the license.

Remedy:

For fault value = 0:
Additional licenses are required and these must be activated (p9920, p9921).

For fault value = 1:
With the system powered down, re-insert the memory card that matches the system.

For fault value = 2:
Enter and activate the license key (p9920, p9921).

For fault value = 3:
Compare the license key (p9920) entered with the license key on the certificate of license.
Re-enter the license key and activate (p9920, p9921).

For fault value = 4:
- carry out a POWER ON.
- upgrade firmware to later version.
- contact Technical Support.

Note:
An overview of the drive device functions requiring a license can be displayed using a commissioning tool in the online mode. Depending on the commissioning tool, you can obtain the necessary licenses (serial number, license Key, Trial License Mode).

A13001 Error in license checksum

Reaction: NONE

Acknowledge: NONE

Cause: When checking the checksum of the license key, an error was detected.

Remedy: Compare the license key (p9920) entered with the license key on the certificate of license.
Re-enter the license key and activate (p9920, p9921).

F13009 Licensing Technology Extension not licensed

Reaction: OFF1

Acknowledge: IMMEDIATELY

Cause: At least one Technology Extension that requires a license does not have a license.

Note:
Refer to r4955 and p4955 for information about the installed Technology Extensions.

Remedy:

- enter and activate the license key for Technology Extensions that require a license (p9920, p9921).
- if necessary, deactivate Technology Extensions that are not licensed (p4956).

F13010 Licensing function module not licensed

Reaction: OFF1

Acknowledge: IMMEDIATELY

Cause: At least one function module requiring a license is not licensed.
 Fault value (r0949, interpret hexadecimal):
 Bit x = 1: The corresponding function module does not have a license.
 Note:
 Assigning bit number to function module, see p0108 or r0108.

Remedy: - enter and activate the license key for function modules that require a license license (p9920, p9921).
 - if necessary, deactivate unlicensed function modules (p0108, r0108).

A13021 Licensing for output frequencies > 550 Hz missing

Reaction: NONE
Acknowledge: NONE
Cause: Configuring the converter results in an output frequency greater than 550 Hz. This function requires a license. The "High Output Frequency" license is required.
 Note:
 - in this specific case, the output frequency is limited to 550 Hz.
 - the "Trial License" function is not effective for license "High Output Frequency".

Remedy: - enter and activate the license key for "High Output Frequency" and activate (p9920, p9921).
 - if necessary operate the motor below the output frequency of 550 Hz.

A13030 Trial License activated

Reaction: NONE
Acknowledge: NONE
Cause: The "Trial License" function was activated. One of the available periods is expiring.
Remedy: Not necessary.
 The alarm is automatically withdrawn after the periods have expired.

A13031 Trial License period expired

Reaction: NONE
Acknowledge: NONE
Cause: One of the available periods of the "Trial License" function has expired.
Remedy: - if required, start an additional period (p9918 = 1).
 - deactivate functions requiring a license.
 - appropriately license the drive unit.
 Note:
 A license that is not adequate will only become evident after the next time the system runs up.

A13032 Trial License last period activated

Reaction: NONE
Acknowledge: NONE
Cause: The "Trial License" function was activated. The last of the available periods is expiring.
Remedy: Not necessary.
 The alarm is automatically withdrawn after the last period has expired.

A13033 Trial License last period expired

Reaction: NONE
Acknowledge: NONE
Cause: The last period of the "Trial License" function has expired. No additional periods available.

15.2 List of faults and alarms

Remedy: - deactivate functions requiring a license.
- appropriately license the drive unit.
Note:
A license that is not adequate will only become evident after the next time the system runs up.

F13100 **Know-how protection: Copy protection error**
Reaction: OFF1
Acknowledge: IMMEDIATELY
Cause: The know-how protection with copy protection for the memory card is active.
An error has occurred when checking the memory card.
Fault value (r0949, interpret decimal):
0: A memory card is not inserted.
2: An invalid memory card is inserted.
3: The memory card is being used in another Control Unit.
12: An invalid memory card is inserted (OEM input incorrect, p7769).
13: The memory card is being used in another Control Unit (OEM input incorrect, p7759).
Remedy: For fault value = 0:
- insert the correct memory card and carry out POWER ON.
For fault value = 2, 3, 12, 13:
- contact the responsible OEM.
- Deactivate copy protection (p7765) and acknowledge the fault (p3981).
- Deactivate know-how protection (p7766 ... p7768) and acknowledge the fault (p3981).
Note:
In general, the copy protection can only be changed when know-how protection is deactivated.
KHP: Know-How Protection

F13101 **Know-how protection: Copy protection cannot be activated**
Reaction: NONE
Acknowledge: IMMEDIATELY
Cause: An error occurred when attempting to activate the copy protection for the memory card.
Fault value (r0949, interpret decimal):
0: A memory card is not inserted.
Note:
KHP: Know-How Protection
Remedy: - insert the memory card and carry out POWER ON.
- Try to activate copy protection again (p7765).

F13102 **Know-how protection: Consistency error of the protected data**
Reaction: OFF1
Acknowledge: IMMEDIATELY

Cause: An error was identified when checking the consistency of the protected files. As a consequence, the project on the memory card cannot be run.
 Fault value (r0949, interpret hexadecimal):
 yyyyxxx hex: yyyy = object number, xxx = fault cause
 xxx = 1:
 A file has a checksum error.
 xxx = 2:
 The files are not consistent with one another.
 xxx = 3:
 The project files, which were loaded into the file system via load (download from the memory card), are inconsistent.
 Note:
 KHP: Know-How Protection

Remedy:

- Replace the project on the memory card or replace project files for download from the memory card.
- Restore the factory setting and download again.

F30001 Drive: overcurrent

Reaction: OFF2

Acknowledge: IMMEDIATELY

Cause: The drive has detected an overcurrent condition.

- closed-loop control is incorrectly parameterized.
- motor has a short-circuit or fault to ground (frame).
- the rated motor current is significantly higher than that of the drive.
- infeed: High discharge and post-charging currents for line voltage dip.
- infeed: High post-charging currents for overload when motoring and DC link voltage dip.
- infeed: Short-circuit currents at switch-on as there is no commutating reactor.
- power cables are not correctly connected.
- the power cables exceed the maximum permissible length.
- defective drive.
- line phase interrupted.

Fault value (r0949, interpret bitwise binary):
 Bit 0: Phase U.
 Bit 1: Phase V.
 Bit 2: Phase W.
 Bit 3: Overcurrent in the DC link.
 Note:
 Fault value = 0 means that the phase with overcurrent is not recognized.

Remedy:

- check the motor data - if required, carry out commissioning.
- check the assignment of the rated motor and drive currents.
- infeed: Check the line supply quality.
- infeed: Reduce the motor load.
- infeed: Check the correct connection of the line filter and the line commutating reactor.
- check the power cable connections.
- check the power cables for short-circuit or ground fault.
- check the length of the power cables.
- replace drive.
- check the line supply phases.

F30002 Drive: DC link overvoltage

Reaction: OFF2

Acknowledge: IMMEDIATELY

15.2 List of faults and alarms

Cause: The drive has detected an overvoltage condition in the DC link.
- motor regenerates too much energy.
- device supply voltage too high.
- line phase interrupted.

Fault value (r0949, interpret decimal):
DC link voltage at the time of trip [0.1 V].

Remedy:
- increase the ramp-down time
- use a braking resistor.
- use a drive with a higher power rating.
- check the device supply voltage (p0210).
- check the line supply phases.
See also: p0210 (Drive unit line supply voltage)

F30003 Drive: DC link undervoltage

Reaction: OFF2

Acknowledge: IMMEDIATELY

Cause: The power unit has detected an undervoltage condition in the DC link.
- line supply failure
- line supply voltage below the permissible value.
- line supply infeed failed or interrupted.
- line phase interrupted.

Remedy:
- check the line supply voltage
- check the line supply infeed and observe the fault messages relating to it (if there are any)
- check the line supply phases.
- check the line supply voltage setting (p0210).
See also: p0210 (Drive unit line supply voltage)

F30004 Power unit: Overtemperature heat sink AC inverter

Reaction: OFF2

Acknowledge: IMMEDIATELY

Cause: The temperature of the power unit heat sink has exceeded the permissible limit value.
- insufficient cooling, fan failure.
- overload.
- ambient temperature too high.
- pulse frequency too high.

Fault value (r0949, interpret decimal):
Temperature [0.01 °C].

Remedy:
- check whether the fan is running.
- check the fan elements.
- check whether the ambient temperature is in the permissible range.
- check the motor load.
- reduce the pulse frequency if this is higher than the rated pulse frequency.

Notice:

This fault can only be acknowledged after the alarm threshold for alarm A05000 has been undershot.

F30005 Power unit: Overload I2t

Reaction: OFF2

Acknowledge: IMMEDIATELY

Cause: The power unit was overloaded (r0036 = 100 %).
 - the permissible rated power unit current was exceeded for an inadmissibly long time.
 - the permissible load duty cycle was not maintained.
 Fault value (r0949, interpret decimal):
 I2t [100 % = 16384].

Remedy:
 - reduce the continuous load.
 - adapt the load duty cycle.
 - check the motor and power unit rated currents.
 See also: r0307 (Rated motor power)

F30011 Power unit: Line phase failure in main circuit

Reaction: OFF2
Acknowledge: IMMEDIATELY
Cause: At the power unit, the DC link voltage ripple has exceeded the permissible limit value.
 Possible causes:
 - a line phase has failed.
 - the 3 line phases are inadmissibly asymmetrical.
 - the capacitance of the DC link capacitor forms a resonance frequency with the line inductance and the reactor integrated in the power unit.
 - the fuse of a phase of a main circuit has ruptured.
 - a motor phase has failed.
 - for power units operated on a single phase, the permissible active power was exceeded.
 Fault value (r0949, interpret decimal):
 Only for internal Siemens troubleshooting.

Remedy:
 - check the main circuit fuses.
 - check whether a single-phase load is distorting the line voltages.
 - Detune the resonant frequency with the line inductance by using an upstream line reactor.
 - Dampen the resonant frequency with the line inductance by switching over the DC link voltage compensation in the software (see p1810) – or increase the smoothing (see p1806). However, this can have a negative impact on the torque ripple at the motor output.
 - check the motor feeder cables.

F30015 Drive: phase failure motor cable

Reaction: OFF2
Acknowledge: IMMEDIATELY
Cause: A phase failure in the motor feeder cable was detected.
 The signal can also be output in the following case:
 The motor is correctly connected, however the closed-speed control is instable and therefore an oscillating torque is generated.

Remedy:
 - check the motor feeder cables.
 - check the speed controller settings.

A30016 Power unit: Load supply switched off

Reaction: NONE
Acknowledge: NONE
Cause: The DC link voltage is too low.
 Alarm value (r2124, interpret decimal):
 DC link voltage at the time of the trip [V].

Remedy:
 - switch on load supply.
 - check the line supply if necessary.

F30017 Power unit: Hardware current limit has responded too often

Reaction: OFF2

Acknowledge: IMMEDIATELY

Cause: The hardware current limitation in the relevant phase (see A30031, A30032, A30033) has responded too often. The number of times the limit has been exceeded depends on the design and type of power unit.

For infeed units, the following applies:

- closed-loop control is incorrectly parameterized.
- load on the infeed is too high.
- line reactor missing or the incorrect type.
- power unit defective.

The following applies to Motor Modules:

- closed-loop control is incorrectly parameterized.
- fault in the motor or in the power cables.
- the power cables exceed the maximum permissible length.
- motor load too high
- power unit defective.

Fault value (r0949, interpret binary):

Bit 3: phase U

Bit 4: phase V

Bit 5: phase W

Additional bits:

Only for internal Siemens troubleshooting.

Note:

Fault value = 0 means that the phase with current limiting is not recognized (e.g. for blocksize device).

Remedy: For infeed units, the following applies:

- check the controller settings and reset and identify the controller if necessary (p0340 = 2, p3410 = 5)
- reduce the load and increase the DC link capacitance or use a higher-rating infeed if necessary
- check the connection and technical data of the commutating reactor.
- check the power cables for short-circuit or ground fault.
- replace power unit.

The following applies to Motor Modules:

- check the motor data and if required, recalculate the controller parameters (p0340 = 3). As an alternative, run a motor data identification (p1910 = 1, p1960 = 1).
- check the motor circuit configuration (star-delta).
- check the motor load.
- check the power cable connections.
- check the power cables for short-circuit or ground fault.
- check the length of the power cables.
- replace power unit.

F30021 Drive: ground fault

Reaction: OFF2

Acknowledge: IMMEDIATELY

Cause: The drive has detected a ground fault.
Possible causes:

- ground fault in the power cables.
- ground fault at the motor.
- when the brake closes, this causes the hardware DC current monitoring to respond.
- short-circuit at the braking resistor.

Fault value (r0949, interpret decimal):

0:

- the hardware DC current monitoring has responded.
- short-circuit at the braking resistor.

> 0:
Absolute value summation current amplitude.

Remedy:

- check the power cable connections.
- check the motor.
- check the cables and contacts of the brake connection (a wire is possibly broken).
- check the braking resistor.

F30024 Power unit: Overtemperature thermal model

Reaction: OFF2

Acknowledge: IMMEDIATELY

Cause: The temperature difference between the heat sink and chip has exceeded the permissible limit value.

- the permissible load duty cycle was not maintained.
- insufficient cooling, fan failure.
- overload.
- ambient temperature too high.
- pulse frequency too high.

See also: r0037 (Drive temperatures)

Remedy:

- adapt the load duty cycle.
- check whether the fan is running.
- check the fan elements.
- check whether the ambient temperature is in the permissible range.
- check the motor load.
- reduce the pulse frequency if this is higher than the rated pulse frequency.

F30025 Power unit: Chip overtemperature

Reaction: OFF2

Acknowledge: IMMEDIATELY

Cause: The chip temperature of the semiconductor has exceeded the permissible limit value.

- the permissible load duty cycle was not maintained.
- insufficient cooling, fan failure.
- overload.
- ambient temperature too high.
- pulse frequency too high.

Fault value (r0949, interpret decimal):
Temperature difference between the heat sink and chip [0.01 °C].

15.2 List of faults and alarms

- Remedy:**
- adapt the load duty cycle.
 - check whether the fan is running.
 - check the fan elements.
 - check whether the ambient temperature is in the permissible range.
 - check the motor load.
 - reduce the pulse frequency if this is higher than the rated pulse frequency.

Notice:

This fault can only be acknowledged after the alarm threshold for alarm A05001 has been undershot.

See also: r0037 (Drive temperatures)

F30027 **Power unit: Precharging DC link time monitoring**

Reaction: OFF2

Acknowledge: IMMEDIATELY

- Cause:** The power unit DC link was not able to be precharged within the expected time.
- 1) There is no line supply voltage connected.
 - 2) The line contactor/line side switch has not been closed.
 - 3) The line supply voltage is too low.
 - 4) Line supply voltage incorrectly set (p0210).
 - 5) The precharging resistors are overheated as there were too many precharging operations per time unit.
 - 6) The precharging resistors are overheated as the DC link capacitance is too high.
 - 7) The precharging resistors are overheated because when there is no "ready for operation" (r0863.0) of the infeed unit, power is taken from the DC link.
 - 8) The precharging resistors are overheated as the line contactor was closed during the DC link fast discharge through the Braking Module.
 - 9) The DC link has either a ground fault or a short-circuit.
- Fault value (r0949, interpret binary):
 yyyyxxxx hex:
 yyyy = power unit state
- 0: Fault status (wait for OFF and fault acknowledgment).
 - 1: Restart inhibit (wait for OFF).
 - 2: Overvoltage condition detected -> change into the fault state.
 - 3: Undervoltage condition detected -> change into the fault state.
 - 4: Wait for bridging contactor to open -> change into the fault state.
 - 5: Wait for bridging contactor to open -> change into restart inhibit.
 - 6: Wait for bypass contactor to open
 - 7: Commissioning.
 - 8: Ready for precharging.
 - 9: Precharging started, DC link voltage lower than the minimum switch-on voltage
 - 10: Precharging, DC link voltage end of precharging still not detected
 - 11: Wait for the end of the de-bounce time of the main contactor after precharging has been completed.
 - 12: Precharging completed, ready for pulse enable.
 - 13: It was detected that the STO terminal was energized at the power unit
- xxxx = Missing internal enable signals, power unit (inverted bit-coded, FFFF hex -> all internal enable signals available)
- Bit 0: Power supply of the IGBT gating shut down.
 Bit 1: Ground fault detected.
 Bit 2: Peak current intervention.
 Bit 3: I2t exceeded.
 Bit 4: Thermal model overtemperature calculated.
 Bit 5: (heat sink, gating module, power unit) overtemperature measured.
 Bit 6: Reserved.
 Bit 7: Overvoltage detected.
 Bit 8: Power unit has completed precharging, ready for pulse enable.
 Bit 9: STO terminal missing.
 Bit 10: Overcurrent detected.
 Bit 11: Armature short-circuit active.
 Bit 12: DRIVE-CLiQ fault active.
 Bit 13: Vce fault detected, transistor de-saturated due to overcurrent/short-circuit.
 Bit 14: Undervoltage detected.
- See also: p0210 (Drive unit line supply voltage)

15.2 List of faults and alarms

Remedy: In general:

- check the line supply voltage at the input terminals.
- check the line supply voltage setting (p0210).

For 5):

- carefully observe the permissible precharging frequency (refer to the appropriate Manual).

For 6):

- check the total capacitance of the DC link and reduce in accordance with the maximum permissible DC link capacitance if necessary (refer to the appropriate Manual).

For 7):

- interconnect the ready-for-operation signal from the infeed unit (r0863.0) in the enable logic of the drives connected to this DC link

For 8):

- check the connections of the external line contactor. The line contactor must be open during DC link fast discharge.

For 9):

- check the DC link for ground faults or short circuits.

For 11):

- check the DC link voltage of the infeed (r0070) and Motor Modules (r0070).

If the DC link voltage generated by the infeed (or external) is not displayed for the Motor Modules (r0070), then a fuse has ruptured in the Motor Module.

See also: p0210 (Drive unit line supply voltage)

A30031 Power unit: Hardware current limiting in phase U

Reaction: NONE

Acknowledge: NONE

Cause: Hardware current limit for phase U responded. The pulsing in this phase is inhibited for one pulse period.

- closed-loop control is incorrectly parameterized.
- fault in the motor or in the power cables.
- the power cables exceed the maximum permissible length.
- motor load too high
- power unit defective.

Note:

Alarm A30031 is always output if, for a Power Module, the hardware current limiting of phase U, V or W responds.

Remedy:

- check the motor data and if required, recalculate the control parameters (p0340 = 3). As an alternative, run a motor data identification (p1910 = 1, p1960 = 1).
- check the motor circuit configuration (star/delta).
- check the motor load.
- check the power cable connections.
- check the power cables for short-circuit or ground fault.
- check the length of the power cables.

A30034 Power unit: Internal overtemperature

Reaction: NONE

Acknowledge: NONE

Cause: The alarm threshold for internal overtemperature has been reached.
 If the temperature inside the power unit increases up to the fault threshold, then fault F30036 is triggered.
 - ambient temperature might be too high.
 - insufficient cooling, fan failure.
 Alarm value (r2124, interpret binary):
 Bit 0 = 1: Overtemperature in the control electronics area.
 Bit 1 = 1: Overtemperature in the power electronics area.
 Bit 2 = 1: Overtemperature in the processor area.
 Bit 3 = 1: Overtemperature in the processor area.
 Bit 4 = 1: Overtemperature when the internal fan is defective.
 Bit 5 = 1: Intake air overtemperature.

Remedy:
 - check the ambient temperature.
 - check the fan for the inside of the unit.

F30036 Power unit: Internal overtemperature

Reaction: OFF2
Acknowledge: IMMEDIATELY
Cause: The temperature inside the converter has exceeded the permissible limit value.
 - insufficient cooling, fan failure.
 - overload.
 - ambient temperature too high.
 Fault value (r0949, interpret binary):
 Bit 0 = 1: Overtemperature in the control electronics area.
 Bit 1 = 1: Overtemperature in the power electronics area.
 Bit 2 = 1: Overtemperature in the processor area.
 Bit 3 = 1: Overtemperature in the processor area.
 Bit 4 = 1: Overtemperature when the internal fan is defective.
 Bit 5 = 1: Intake air overtemperature.

Remedy:
 - check the internal fan.
 - check the fan elements.
 - check whether the ambient temperature is in the permissible range.
 Notice:
 This fault can only be acknowledged once the permissible temperature limit minus 5 K has been fallen below.

F30040 Drive: 24/48 V undervoltage

Reaction: OFF2
Acknowledge: IMMEDIATELY
Cause: The undervoltage threshold of the 24 V power supply for the drive was fallen below for longer than 3 ms.
 Fault value (r0949, interpret hexadecimal):
 yyxxxx hex: yy = channel, xxxx = voltage [0.1 V]
 yy = 0: 24 V power supply
 yy = 1: 48 V power supply

Remedy:
 - check the drive power supply.
 - carry out a POWER ON (switch-off/switch-on).

A30041 Power unit: Undervolt 24/48 V alarm

Reaction: NONE
Acknowledge: NONE

15.2 List of faults and alarms

Cause: For the power unit power supply, the lower threshold has been violated.

Alarm value (r2124, interpret hexadecimal):
yyxxxx hex: yy = channel, xxxx = voltage [0.1 V]
yy = 0: 24 V power supply
yy = 1: 48 V power supply

Remedy: - check the power supply of the power unit.
- carry out a POWER ON (switch-off/switch-on) for the component.

A30042 Power unit: Fan has reached the maximum operating hours

Reaction: NONE

Acknowledge: NONE

Cause: The maximum operating time of at least one fan will soon be reached, or has already been exceeded.

Alarm value (r2124, interpret binary):

Bit 0 = 1:

The operating hours counter of the heat sink fan will reach the maximum operating time in 500 hours. After 500 hours has elapsed, bit 0 is cleared and bit 2 is set in the alarm value.

Bit 1 = 1:

The wear counter of the heat sink fan has reached 99 %. The remaining service life is 1%. After this 1% has elapsed, bit 1 is cleared and bit 2 is set in the alarm value.

Bit 2 = 1:

The operating hours counter of the heat sink fan has exceeded the maximum operating time - and/or the wear counter has exceeded 100%.

Bit 8 = 1:

The operating hours counter of the fan inside the device will reach the maximum operating time in 500 hours. After 500 hours has elapsed, bit 8 is cleared and bit 10 is set in the alarm value.

Bit 10 = 1:

The operating hours counter of the fan inside the device has exceeded the maximum operating time.

Remedy: For the fan involved, carry out the following:
- replace the fan.
- reset the operating hours counter (p0251, p0254).
See also: p0251 (Power unit heat sink fan operating hours counter)

F30043 Power unit: Overvolt 24/48 V

Reaction: OFF2

Acknowledge: POWER ON

Cause: For the power unit power supply, the upper threshold has been violated.

Fault value (r0949, interpret hexadecimal):
yyxxxx hex: yy = channel, xxxx = voltage [0.1 V]
yy = 0: 24 V power supply
yy = 1: 48 V power supply

Remedy: Check the power supply of the power unit.

A30044 Power unit: Overvolt 24/48 V alarm

Reaction: NONE

Acknowledge: NONE

Cause: For the power unit power supply, the upper threshold has been violated.

Alarm value (r2124, interpret hexadecimal):
yyxxxx hex: yy = channel, xxxx = voltage [0.1 V]
yy = 0: 24 V power supply
yy = 1: 48 V power supply

Remedy: Check the power supply of the power unit.

F30050 Power unit: 24 V supply overvoltage

Reaction: OFF2
Acknowledge: POWER ON
Cause: The voltage monitor signals an overvoltage fault on the module.
Remedy: - check the 24 V power supply.
 - replace the module if necessary.

F30051 Power unit: Motor holding brake short circuit detected

Reaction: OFF2
Acknowledge: IMMEDIATELY
Cause: A short-circuit at the motor holding brake terminals has been detected.
 Fault value (r0949, interpret decimal):
 Only for internal Siemens troubleshooting.
Remedy: - check the motor holding brake for a short-circuit.
 - check the connection and cable for the motor holding brake.

F30052 EEPROM data error

Reaction: OFF2
Acknowledge: POWER ON
Cause: EEPROM data error of the power unit module.
 Fault value (r0949, interpret decimal):
 0, 2, 3, 4:
 The EEPROM data read in from the power unit module are incorrect.
 1:
 EEPROM data is not compatible to the firmware of the power unit application.
 Additional values:
 Only for internal Siemens troubleshooting.
Remedy: For fault value = 0, 2, 3, 4:
 Replace the power unit module or update the EEPROM data.
 For fault value = 1:
 The following applies for CU31x and CUA31:
 Update the firmware \SIEMENS\SINAMICS\CODE\SAC\cu31xi.ufw (cua31.ufw)

A30054 Power unit: Undervoltage when opening the brake

Reaction: NONE
Acknowledge: NONE
Cause: When the brake is being opened, it is detected that the power supply voltage is less than 21.4 V
 Alarm value (r2124, interpret decimal):
 Supply voltage fault [0.1 V].
 Example:
 Alarm value = 195 --> voltage = 19.5 V
Remedy: Check the 24 V voltage for stability and value.

F30055 Power unit: Braking chopper overcurrent

Reaction: OFF2
Acknowledge: IMMEDIATELY
Cause: An overcurrent condition has occurred in the braking chopper.

15.2 List of faults and alarms

Remedy:

- check whether the braking resistor has a short circuit.
- for an external braking resistor, check whether the resistor may have been dimensioned too small.

Note:

The braking chopper is only enabled again at pulse enable after the fault has been acknowledged.

F30068 Power unit: undertemperature inverter heat sink

Reaction: OFF2

Acknowledge: IMMEDIATELY

Cause: The actual inverter heat sink temperature is below the permissible minimum value.

Possible causes:

- the power unit is being operated at an ambient temperature that lies below the permissible range.
- the temperature sensor evaluation is defective.

Fault value (r0949, interpret decimal):

Inverter heat sink temperature [0.1 °C].

Remedy:

- ensure that higher ambient temperatures prevail.
- replace the power unit.

F30075 Configuration of the power unit unsuccessful

Reaction: OFF2

Acknowledge: IMMEDIATELY

Cause: A communication error has occurred while configuring the power unit using the Control Unit. The cause is not clear.

Fault value (r0949, interpret decimal):

0:

The output filter initialization was unsuccessful.

1:

Activation/deactivation of the regenerative feedback functionality was unsuccessful.

2:

Activation/deactivation of the chopper function was unsuccessful.

Remedy:

- acknowledge the fault and continue operation.
- if the fault reoccurs, carry out a POWER ON (switch-off/switch-on).
- if required, replace the power unit.

A30076 Power unit: thermal overload internal braking resistor alarm

Reaction: NONE

Acknowledge: NONE

Cause: The energy absorbed by the internal braking resistor has exceeded the alarm threshold of 80 %. If the power unit is still operated in the generator mode, then this can reach the shutdown threshold. To avoid overheating of the braking resistor, use of the braking resistor is inhibited and alarm A30077 is output.

Alarm value (r2124, interpret decimal):

Energy absorbed by the braking resistor [Ws].

Remedy: Reduce the power when generating.

Note:

For a DC link coupling, the generating power of all of the coupled power units must be taken into consideration.

A30077 Power unit: thermal overload internal braking resistor

Reaction: NONE

Acknowledge: NONE

Cause: The internal braking resistor is thermally overloaded. This is the reason that its use was inhibited.

Alarm value (r2124, interpret decimal):

Energy absorbed by the braking resistor [Ws].

Remedy: Reduce the power when generating.
Note:
 - once the internal braking resistor has thermally recovered, it is enabled for further use.
 - for a DC link coupling, the generating power of all the coupled power units must be taken into consideration.

F30078 Power unit: defective fan or line reactor has overheated

Reaction: OFF2
Acknowledge: IMMEDIATELY
Cause: The temperature monitoring of the internal braking resistor or the line reactor has responded. In addition to the OFF2 response, the use of the internal braking resistor was inhibited.
Note:
 - an overtemperature condition of the internal braking resistor can only be initiated as a result of a defective fan.
 - an overtemperature condition of the line reactor can occur when a DC link coupling is used – and if the power when motoring, which is fed into the DC link - is not evenly distributed across the rectifiers of the power units.
Remedy:
 - check the converter fan and replace if necessary.
 - reduce the motoring power.

A30502 Power unit: DC link overvoltage

Reaction: NONE
Acknowledge: NONE
Cause: The power unit has detected overvoltage in the DC link on a pulse inhibit.
 - device supply voltage too high.
 - line reactor incorrectly dimensioned.
 Alarm value (r0949, interpret decimal):
 DC link voltage [1 bit = 100 mV].
 See also: r0070 (Actual DC link voltage)
Remedy:
 - check the device supply voltage (p0210).
 - check the dimensioning of the line reactor.
 See also: p0210 (Drive unit line supply voltage)

F30600 SI P2: STO initiated

Reaction: OFF2
Acknowledge: IMMEDIATELY
Cause: The "Safety Integrated" function integrated in the drive has identified a fault in monitoring channel 2, and has initiated STO.
 - forced checking procedure (test stop) of the safety switch-off signal path of monitoring channel 2 unsuccessful.
 - subsequent response to fault F30611 (defect in a monitoring channel).
 Fault value (r0949, decimal interpretation):
 0: Stop request from another monitoring channel.
 1005: STO active, although no STO is selected and no stop response with STO is active.
 1010: STO inactive, although STO is selected or a stop response with STO is active.
 1011: internal error for STO deselected in monitoring channel 2.
 9999: Subsequent response to fault F30611.
Remedy:
 - select Safe Torque Off and deselect again.
 - carry out a POWER ON (switch-off/switch-on) for all components.
 - replace drive.
 For fault value = 9999:
 - carry out diagnostics for fault F30611.
Note:
 SI: Safety Integrated
 STO: Safe Torque Off

F30611 **SI P2: Defect in a monitoring channel**

Reaction: NONE

Acknowledge: IMMEDIATELY

Cause: The "Safety Integrated" function integrated in the drive has identified a fault in monitoring channel 2. As a result of this fault, after the parameterized transition time has elapsed (p9658), fault F01600 is output.

Fault value (r0949, interpret decimal):

0: Stop request from another monitoring channel.

1 ... 999:

Number of the cross-compared data that resulted in this fault.

2: SI enable safety functions (p9601). Crosswise data comparison is only carried out for the supported bits.

3: SI SGE changeover discrepancy time (p9650).

4: SI transition time from F01611 to STO (p9658).

5: SI enable Safe Brake Control (p9602).

6: SI Motion enable safety functions (p9501).

7: SI delay time of STO for Safe Stop 1 (p9652).

8: SI PROFIsafe address (p9610).

9: SI debounce time for STO/SBC/SS1 (p9651).

14: SI PROFIsafe telegram selection (p9611).

15: SI PROFIsafe bus failure response (p9612).

1000: Watchdog timer has expired.

Within the time of approx. 5 x p9650, alternatively, the following was defined:

- the signal at F-DI for STO continually changes with time intervals less than or equal to the discrepancy time (p9650).

- via PROFIsafe, STO (also as subsequent response) was continually selected and deselected with time intervals less than or equal to the discrepancy time (p9650).

1001, 1002: Initialization error, change timer / check timer.

1950: Module temperature outside the permissible temperature range.

1951: Module temperature not plausible.

2000: Status of the STO selection for both monitoring channels different.

2001: Feedback signal of STO shutdown for both monitoring channels different. This value can also subsequently occur as a result of other faults.

2002: Status of the delay timer SS1 on both monitoring channels are different (status of the timer in p9650).

2003: Status of the STO terminal for both monitoring channels different.

6000 ... 6999:

Error in the PROFIsafe control.

For these fault values, the failsafe control signals (Failsafe Values) are transferred to the safety functions. For p9612 = 1, the transfer of Failsafe Values is delayed.

The significance of the individual message values is defined in message F01611.

Remedy:

- For fault value = 1 ... 5 and 7 ... 999:
 - check the data that caused the fault.
 - upgrade the drive software.
 - carry out a POWER ON (switch-off/switch-on).
- For fault value = 1000:
 - check the wiring of the safety-relevant inputs (SGE) in the first monitoring channel (contact problems).
 - PROFIsafe: Resolve contact problems/faults at the PROFINET controller.
 - check the discrepancy time, and if required, increase the value (p9650).
- For fault value = 1001, 1002:
 - carry out a POWER ON (switch-off/switch-on).
 - upgrade the drive software.
- For fault value = 1950:
 - operate the module in the permissible range.
 - test module fan, replace drive.
- For fault value = 1951:
 - operate the module in the permissible range.
 - replace drive.
- For fault value = 2000, 2001, 2002, 2003:
 - check the discrepancy time, and if required, increase the value (p9650, p9652).
 - check the wiring of the F-DI for STO/SBC/SS1 (contact problems).
 - replace drive.
 - diagnose the other active faults and resolve the causes.

Note:
 This fault can be acknowledged after removing the cause of the error and after correct selection/deselection of STO.

For fault value = 6000 ... 6999:
 Refer to the description of the message values for safety message F01611.

Note:
 SGE: Safety-relevant input
 F-DI: Failsafe Digital Input
 SI: Safety Integrated
 SS1: Safe Stop 1
 STO: Safe Torque Off

N30620 SI P2: Safe Torque Off active

Reaction: NONE

Acknowledge: NONE

Cause: The "Safe Torque Off" (STO) function of the basic functions has been selected in monitoring channel 2 using the input terminal and is active.

Note:
 - this message does not result in a safety stop response.
 - this message is not output when STO is selected using the Extended Functions.

Remedy: Not necessary.

Note:
 SI: Safety Integrated
 STO: Safe Torque Off

N30621 SI P2: Safe Stop 1 active

Reaction: NONE

Acknowledge: NONE

15.2 List of faults and alarms

Cause: The "Safe Stop 1" function (SS1) was selected in monitoring channel 2 and is active.

Note:

This message does not result in a safety stop response.

Remedy: Not necessary.

Note:

SI: Safety Integrated

SS1: Safe Stop 1

F30625 SI P2: Sign-of-life error in safety data

Reaction: OFF2

Acknowledge: IMMEDIATELY

Cause: The "Safety Integrated" function integrated in the drive has identified an error in the sign-of-life of the safety data in monitoring channel 2, and has initiated STO.

- there is either a DRIVE-CLiQ communication error or communication has failed.
- a time slice overflow of the safety software has occurred.
- the enable of the safety functions in both monitoring channels is inconsistent.

Fault value (r0949, interpret decimal):

Only for internal Siemens troubleshooting.

- Remedy:**
- select STO and then deselect again.
 - carry out a POWER ON (switch-off/switch-on).
 - check whether there is a DRIVE-CLiQ communication error between the two monitoring channels and, if required, carry out a diagnostics routine for the faults identified.
 - deselect all drive functions that are not absolutely necessary.
 - check the electrical cabinet design and cable routing for EMC compliance
 - check whether the safety functions are enabled (p9601), copy the safety parameters using the commissioning tool, and confirm the data change.

Note:

P2: processor 2

SI: Safety Integrated

STO: Safe Torque Off

F30630 SI P2: Brake control error

Reaction: OFF2

Acknowledge: IMMEDIATELY

Cause: The "Safety Integrated" function integrated in the drive has identified a brake control fault in monitoring channel 2, and has initiated STO.

- OCC cable shield is not correctly connected.
- defect in the brake control circuit of the drive.

Fault value (r0949, decimal interpretation):

100, 101, 102:
 Fault in "open brake" operation.

- brake not closed or interrupted cable.
- ground fault in brake cable.

300, 301, 302:
 Fault in "close brake" operation.

- brake not closed or interrupted cable.

200, 201, 202:
 Fault in the "Brake open" state.

- short-circuit in brake winding.
- defective hardware.

400, 401, 402:
 Fault in "brake closed" state.

60, 70:
 Fault in the brake control of the drive or a communication error between the monitoring channels (brake control diagnostics).

Remedy:

- select STO and then deselect again.
- check the motor holding brake connection.
- check the function of the motor holding brake.
- carry out a diagnostics routine for the faults involved.
- check for EMC-compliant control cabinet design and cable routing (e.g. shield OCC cable with shield terminal and shield plate, check the connection of the brake conductors).
- replace drive.

Note:
 OCC: One Cable Connection (one cable system)
 SBC: Safe Brake Control
 SI: Safety Integrated
 STO: Safe Torque Off

F30649 SI P2: Internal software error

Reaction: OFF2

Acknowledge: IMMEDIATELY

Cause: An internal error in the Safety Integrated software in monitoring channel 2 has occurred.

Note:
 This fault results in an STO that cannot be acknowledged.
 Fault value (r0949, interpret hexadecimal):
 Only for internal Siemens troubleshooting.

Remedy:

- carry out a POWER ON (switch-off/switch-on).
- re-commission the "Safety Integrated" function and carry out a POWER ON.
- upgrade the drive firmware to a later version.
- contact Technical Support.
- replace drive.

Note:
 SI: Safety Integrated
 STO: Safe Torque Off

F30650 SI P2: Acceptance test required

Reaction: OFF2

15.2 List of faults and alarms

Acknowledge: IMMEDIATELY

Cause: The "Safety Integrated" function on monitoring channel 2 requires an acceptance test.

Note:
This fault results in an STO that can be acknowledged.
Fault value (r0949, interpret decimal):
130: Safety parameters for monitoring channel 2 not available.

Note:
This fault value is always output when Safety Integrated is commissioned for the first time.
1000: Reference and actual checksum in monitoring channel 2 are not identical (booting).
- safety parameters set offline and loaded to the drive.
- at least one checksum-checked piece of data is defective.
2000: Reference and actual checksum in monitoring channel 2 are not identical (commissioning mode).
2003: Acceptance test is required as a safety parameter has been changed.
3003: Acceptance test is required as a hardware-related safety parameter has been changed.
9999: Subsequent response of another safety-related fault that occurred when booting that requires an acceptance test.

Remedy:
For fault value = 130:
- carry out safety commissioning routine.
For fault value = 1000:
- again carry out safety commissioning routine.
- replace the memory card or drive.
For fault value = 2000:
- confirm the data change using the commissioning tool.
For fault value = 2003:
- carry out an acceptance test and generate an acceptance report.
For fault value = 3003:
- carry out the function checks for the modified hardware and generate an acceptance report.
For fault value = 9999:
- carry out diagnostics for the other safety-related fault that is present.

Note:
SI: Safety Integrated
STO: Safe Torque Off

F30651 **SI P2: synchronization with monitoring channel 1 unsuccessful**

Reaction: OFF2

Acknowledge: IMMEDIATELY

Cause: The "Safety Integrated" function requires synchronization of the safety time slices in both monitoring channels. This synchronization routine was unsuccessful.

Note:
This fault results in an STO that cannot be acknowledged.
Fault value (r0949, interpret decimal):
Only for internal Siemens troubleshooting.

Remedy:
- carry out a POWER ON (switch-off/switch-on).
- upgrade the drive software.

Note:
SI: Safety Integrated
STO: Safe Torque Off

F30655 **SI P2: Align monitoring functions**

Reaction: OFF2

Acknowledge: IMMEDIATELY

Cause: An error has occurred when aligning the Safety Integrated monitoring functions of both monitoring channels. No common set of supported SI monitoring functions was able to be determined.
 - there is either a DRIVE-CLiQ communication error or communication has failed.
Note:
 This fault results in an STO that cannot be acknowledged.
 Fault value (r0949, interpret hexadecimal):
 Only for internal Siemens troubleshooting.

Remedy:
 - carry out a POWER ON (switch-off/switch-on) for all components.
 - upgrade the drive software.
 - check the electrical cabinet design and cable routing for EMC compliance
Note:
 SI: Safety Integrated
 STO: Safe Torque Off

F30656 SI P2: Parameter error monitoring channel 2

Reaction: OFF2
Acknowledge: IMMEDIATELY
Cause: When accessing the Safety Integrated parameters for monitoring channel 2 in the non-volatile memory, an error has occurred.
Note:
 This fault results in an STO that can be acknowledged.
 Fault value (r0949, interpret decimal):
 129:
 - safety parameters for monitoring channel 2 corrupted.
 131: Internal software error of monitoring channel 1.
 255: Internal software error of monitoring channel 2.

Remedy:
 - re-commission the safety functions.
 - upgrade the drive software.
 - replace the memory card or drive.
 For fault value = 129:
 - activate the Safety Integrated commissioning mode.
 - adapt the PROFIsafe address.
 - copy the safety parameters and confirm the data change.
 - exit the Safety Integrated commissioning mode.
 - save all parameters or "Copy RAM to ROM".
 - carry out a POWER ON (switch-off/switch-on).
Note:
 SI: Safety Integrated
 STO: Safe Torque Off

F30657 SI P2: PROFIsafe telegram number invalid

Reaction: OFF2
Acknowledge: POWER ON
Cause: The PROFIsafe telegram number that has been set is not valid.
 When PROFIsafe is enabled (p9601.3 = 1), then telegram number 30 or 901 must be used.
 The copy function was not used.
Note:
 This fault does not result in a safety stop response.
 See also: p9611 (SI PROFIsafe telegram selection), r60022 (PROFIsafe telegram selection)

Remedy: Enter a valid PROFIsafe telegram number (p9611 = 30, 901).

F30659	SI P2: Write request for parameter rejected
Reaction:	OFF2
Acknowledge:	IMMEDIATELY
Cause:	The write request for one or several Safety Integrated parameters in monitoring channel 2 was rejected. Note: See also fault F01659.
Remedy:	Upgrade the firmware to later version.

F30674	SI Motion P2: Safety function not supported by PROFIsafe telegram
Reaction:	OFF2
Acknowledge:	POWER ON
Cause:	The monitoring function enabled in p9501 and p9601 is not supported by the currently set PROFIsafe telegram (p9611). Note: This fault does not result in a safety stop response. Fault value (r0949, interpret bitwise binary): Bit 18 = 1: SS2E via PROFIsafe is not supported (p9501.18). Bit 24 = 1: Transfer SLS limit value via PROFIsafe not supported (p9501.24).
Remedy:	- Deselect the monitoring function involved (p9501, p9601). - set the matching PROFIsafe telegram (p9611). - using the commissioning tool, copy the safety parameters and confirm the data change. Note: SI: Safety Integrated SLS: Safely-Limited Speed SS2E: Safe Stop 2 External (Safe Stop 2 with external stop)

F30680	SI Motion P2: Checksum error safety monitoring functions
Reaction:	OFF2
Acknowledge:	IMMEDIATELY
Cause:	The calculated actual checksum over the safety-relevant parameters does not match the reference checksum saved at the last machine acceptance. Safety-relevant parameters have been changed or a fault is present. Note: This fault results in an STO that can be acknowledged. Fault value (r0949, decimal interpretation): 0: Checksum error for SI parameters for motion monitoring. 1: Checksum error for SI parameters for component assignment.
Remedy:	- check the safety-relevant parameters and if required, correct. - execute the function "Copy RAM to ROM". - if necessary carry out a POWER ON (switch-off/switch-on). - carry out an acceptance test. Note: STO: Safe Torque Off

F30681	SI Motion P1: Incorrect parameter value
Reaction:	OFF2
Acknowledge:	IMMEDIATELY

Cause:	<p>The parameter cannot be parameterized with this value.</p> <p>Note:</p> <p>This message does not result in a safety stop response.</p> <p>Fault value (r0949, interpret decimal):</p> <p>yyyyxxx dec: yyyy = supplementary information, xxxx = parameter</p> <p>yyyy = 0:</p> <p>No additional information available.</p> <p>xxxx = 9301:</p> <p>Enabling function "SSM" (p9501.16) is not permissible in combination with the "Extended functions without selection" function (p9601.5).</p> <p>xxxx = 9347:</p> <p>The hysteresis tolerance is not permissible.</p> <p>xxxx = 9801 and yyyy = 1:</p> <p>If motion monitoring functions integrated in the drive (p9601.2 = 1) and extended functions without selection (p9601.5 = 1) are activated, then PROFIsafe (p9601.3 = 1) is not possible.</p> <p>xxxx = 9801 and yyyy = 2:</p> <p>Extended functions without selection (p9601.5 = 1) are enabled without enabling motion monitoring functions integrated in the drive (p9601.2).</p> <p>xxxx = 9801 and yyyy = 3:</p> <p>Onboard F-DI are enabled without enabling motion monitoring functions integrated in the drive (p9601.2).</p> <p>xxxx = 9801 and yyyy = 5:</p> <p>Transfer of the SLS limit value via PROFIsafe (p9501.24) has been enabled, without enabling PROFIsafe.</p> <p>xxxx = 9801 and yyyy = 11:</p> <p>SS2E (p9501.18 = 1) is enabled without PROFIsafe being enabled.</p> <p>xxxx = 9801 and yyyy = 12:</p> <p>SCA (p9501.28 = 1) is enabled without enabling PROFIsafe.</p>
Remedy:	<p>Correct parameter (if required, also on another monitoring channel, p9601).</p> <p>Note:</p> <p>For different values in the two monitoring channels: using the commissioning tool, copy the safety parameters and confirm the data change.</p> <p>For xxxx = 9301:</p> <p>Deselect Extended Functions without selection (p9601.5).</p> <p>For xxxx = 9317:</p> <p>Further, p9516.0 should be checked.</p> <p>For xxxx = 9347:</p> <p>Using the commissioning tool, copy the safety parameters and confirm the data change.</p> <p>For xxxx = 9801:</p> <p>Using the commissioning tool, copy the safety parameters, confirm the data change and carry out a POWER ON.</p>

F30682 SI Motion P2: Monitoring function not supported

Reaction:	OFF2
Acknowledge:	IMMEDIATELY
Cause:	<p>The monitoring function enabled in p9501, p9506, p9507, p9601 is not supported in this firmware version.</p> <p>Note:</p> <p>This message does not result in a safety stop response.</p> <p>Fault value (r0949, decimal interpretation):</p> <p>Monitoring function not supported.</p>

15.2 List of faults and alarms

Remedy:

- deselect the monitoring function involved (p9501, p9506, p9507, p9601).
- restore the factory setting and repeat commissioning.
- upgrade the firmware.

Note:
SI: Safety Integrated
See also: p9501 (SI Motion enable safety functions), p9601 (SI enable, functions integrated in the drive)

F30683 SI Motion P2: SOS/SLS enable missing

Reaction: OFF2

Acknowledge: IMMEDIATELY

Cause: The safety-relevant basic function "SOS/SLS" is not enabled, although other safety-relevant monitoring functions are enabled.

Note:
This message does not result in a safety stop response.

Remedy: Using the commissioning tool, copy the safety parameters, confirm the data change and carry out a power on.

Note:
SI: Safety Integrated
SLS: Safely-Limited Speed
SOS: Safe Operating Stop

F30685 SI Motion P2: Safely-Limited Speed limit value too high

Reaction: OFF2

Acknowledge: IMMEDIATELY

Cause: The limit value for the function "Safely-Limited Speed" (SLS) is greater than the speed that corresponds to an encoder limit frequency of 500 kHz.

Note:
This message does not result in a safety stop response.
Fault value (r0949, interpret decimal):
Maximum permissible speed.

Remedy: Correct the limit values for SLS and carry out a POWER ON.

Note:
SI: Safety Integrated
SLS: Safely-Limited Speed

A30693 SI P2: Safety parameter settings changed, warm restart/POWER ON required

Reaction: NONE

Acknowledge: NONE

Cause: Safety parameters have been changed; these will only take effect following a warm restart or POWER ON.
Alarm value (r2124, interpret decimal):
Only for internal Siemens diagnostics.

Remedy:

- carry out a warm restart.
- carry out a POWER ON (switch-off/switch-on).

Note:
A POWER ON is required before carrying out the acceptance test.

F30700 SI Motion P2: STO initiated

Reaction: OFF2

Acknowledge: IMMEDIATELY

Cause: The drive is stopped using STO.
Possible causes:

- stop request from another monitoring channel.
- STO not active after parameterized time after test stop selection.
- subsequent response, following messages: A30706, A30714, F30701, A30716

Remedy:

- remove the cause of the fault on the first monitoring channel.
- check the switch-off signal path of the first of monitoring channel (check DRIVE-CLiQ communication).
- carry out diagnostics for the active messages (A30706, A30714, F30701, A30716).
- replace drive.

Note:
SAM: Safe Acceleration Monitor (safe acceleration monitoring)
SI: Safety Integrated
STO: Safe Torque Off

F30701 SI Motion P2: SS1 initiated

Reaction: NONE
Acknowledge: IMMEDIATELY
Cause: The drive is stopped using SS1.
As a result of this fault, after the time parameterized in p9556 has expired, or the speed threshold parameterized in p9560 has been fallen below, message F30700 "SI Motion P2: STO initiated" is output.
Possible causes:

- stop request from another monitoring channel.
- subsequent response, following messages: A30714, A30711, A30707, A30716

Remedy:

- remove the cause of the fault on the first monitoring channel.
- carry out diagnostics for the active messages (A30714, A30711, A30707, A30716).

Note:
SI: Safety Integrated
SS1: Safe Stop 1

A30706 SI Motion P2: SAM/SBR limit exceeded

Reaction: NONE
Acknowledge: NONE
Cause: Motion monitoring functions with encoder (SAM, p9506 = 0):
- after initiating SS1 or SS2, the speed exceeded the set tolerance.
Motion monitoring functions with encoder (SBR, p9506 = 2):
- after initiating SS1 or SLS switchover to the lower speed level, the speed exceeded the set tolerance.
The drive is stopped by message F30700.
Remedy: Check the braking behavior and, if necessary, adapt the parameterization of the parameter settings of the "SAM" or the "SBR" function.
Note:
This message can be acknowledged via PROFIsafe (safe acknowledgment).
SAM: Safe Acceleration Monitor (safe acceleration monitoring)
SBR: Safe Brake Ramp (safe ramp monitoring)
SI: Safety Integrated
SS1: Safe Stop 1
SS2: Safe Stop 2
SLS: Safely-Limited Speed
See also: p9548 (SI Motion SAM actual speed tolerance)

A30707 SI Motion P2: Tolerance for safe operating stop exceeded

Reaction: NONE

15.2 List of faults and alarms

Acknowledge: NONE
Cause: The actual position has moved further away from the target position than the standstill tolerance.
The drive is stopped by message F30701.
Remedy: - check whether safety faults are present and if required carry out the appropriate diagnostic routines for the particular faults.
- check whether the standstill tolerance matches the accuracy and control dynamic performance of the axis.
- carry out a POWER ON (switch-off/switch-on).
Note:
SI: Safety Integrated
SOS: Safe Operating Stop
See also: p9530 (SI Motion standstill tolerance)

F30708 **SI Motion P2: SS2 initiated**
Reaction: STOP2
Acknowledge: IMMEDIATELY
Cause: The drive is stopped using SS2 (braking along the OFF3 down ramp).
"Safe Operating Stop" (SOS) is activated after the parameterized time has expired.
Possible causes:
Subsequent response, following messages: A30714, A30716
See also: p9552 (SI Motion transition time SS2 to SOS)
Remedy: Carry out diagnostics for the active messages (A30714, A30716).
Note:
SI: Safety Integrated
SOS: Safe Operating Stop
SS2: Safe Stop 2

A30709 **SI Motion P2: SS2E initiated**
Reaction: NONE
Acknowledge: NONE
Cause: The drive is stopped using SS2E (braking along a path).
"Safe Operating Stop" (SOS) is activated after the parameterized time has expired.
Possible causes:
Subsequent response, following messages: A30714, A30716
See also: p9553 (SI Motion transition time SS2E to SOS)
Remedy: - remove the cause of the fault at the control.
- carry out diagnostics for the active messages (A30714, A30716).
Note:
SI: Safety Integrated
SOS: Safe Operating Stop
SS2E: Safe Stop 2 External (Safe Stop 2 with external stop)

A30711 **SI Motion P2: Defect in a monitoring channel**
Reaction: NONE
Acknowledge: NONE

Cause: The drive has identified a difference between the input data or results of the monitoring functions and initiated A30711. Safe operation is no longer possible.

At least one monitoring function is active, so that after the parameterized timer has expired, message F30701 is output. The following message values may also occur in the following cases if the cause that is explicitly mentioned does not apply:

- incorrect synchronization.

Message value (r2124, interpret decimal):

0 ... 999:

Number of the cross-compared data that resulted in this message.

The significance of the individual message values is described in message A01711.

- 1000: Watchdog timer has expired. Too many signal changes have occurred at safety-relevant inputs.
- 1001: Initialization error of watchdog timer.
- 1005: STO already active for test stop selection.
- 1011: Acceptance test status between the monitoring channels differ.
- 1012: Plausibility violation of the encoder actual value.
- 1020: Cyc. communication failure between the monit. channels.
- 1021: Cyclic communication failure between the monitoring channel and encoder evaluation.
- 1023: Error in the effectiveness test in the DRIVE-CLiQ encoder
- 1030: Encoder fault detected from another monitoring channel.
- 1045: CRC of the standstill position incorrect.

5000 ... 5140:

PROFIsafe message values.

For these message values, the failsafe control signals (Failsafe Values) are transferred to the safety functions. The significance of the individual message values is described in message A01711.

6000 ... 6166:

PROFIsafe message values (PROFIsafe driver for PROFIBUS DP V1/V2 and PROFINET).

For these message values, the failsafe control signals (Failsafe Values) are transferred to the safety functions. If "SS1 after failure of PROFIsafe communication" is parameterized, then transfer of the Failsafe Values is delayed.

The significance of the individual message values is described in safety fault F01611.

See also: p9555 (SI Motion transition time F01711 to SS1), r9725 (SI Motion diagnostics A01711)

15.2 List of faults and alarms

Remedy:

For message value = 1005:

- check the conditions for deselecting STO.

For message value = 1012:

- upgrade the encoder evaluation firmware to a newer version.
- check encoder parameters to ensure that they are the same (p9515, p9519, p9523, p9524, p9525, p9529).
- start the copy function for encoder parameters (commissioning tool).
- the parameterized encoder does not correspond to the connected encoder - replace the encoder.
- check the electrical cabinet design and cable routing for EMC compliance
- carry out a POWER ON (switch off/switch on) or a warm restart (p0009 = 30, p0976 = 2, 3).
- replace the hardware.

For message value = 1024:

- check the communication link.
- carry out a POWER ON (switch off/switch on) or a warm restart (p0009 = 30, p0976 = 2, 3).
- replace the hardware.

For message value = 1030:

- check the encoder connection.
- if required, replace the encoder.

Adapt the encoder parameterization for the second channel as follows:

- activate the safety commissioning mode (p0010 = 95).
- start the copy function for encoder parameters (commissioning tool).
- exit the safety commissioning mode (p0010 = 0).
- save the parameters in a non-volatile fashion (copy RAM to ROM).
- carry out a POWER ON (switch off/switch on) or a warm restart (p0009 = 30, p0976 = 2, 3).

The following always applies:

- check the encoder connection.
- if required, replace the encoder.

For message value = 6000 ... 6999:

- the significance of the individual message values are described in fault F01611.

For other message values:

- the significance of the individual message values is described in message A01711.

Note:

SI: Safety Integrated
SS1: Safe Stop 1

A30714 SI Motion P2: Safely-Limited Speed exceeded

Reaction: NONE

Acknowledge: NONE

Cause: The drive had moved faster than that specified by the velocity limit value. The drive is stopped by the configured stop response.

Message value (r2124, interpret decimal):

100: SLS1 exceeded.

200: SLS2 exceeded.

300: SLS3 exceeded.

400: SLS4 exceeded.

1000: Encoder limit frequency exceeded.

Remedy:

- check the traversing/motion program in the control.
- check the limits for the "SLS" function and if required adapt.

Note:

SI: Safety Integrated

SLS: Safely-Limited Speed

A30716	SI Motion P2: Tolerance for safe motion direction exceeded
Reaction:	NONE
Acknowledge:	NONE
Cause:	The tolerance for the "safe motion direction" function was exceeded. The drive is stopped by the configured stop response. Message value (r2124, interpret decimal): 0: Tolerance for function "safe motion direction positive" exceeded. 1: Tolerance for function "safe motion direction negative" exceeded.
Remedy:	- check the traversing/motion program in the control. - check the tolerance for the "SDI" function and adapt if necessary. This message can be acknowledged as follows: Deselect/select SDI and perform safe acknowledgment via PROFIsafe. Note: SDI: Safe Direction (safe motion direction) SI: Safety Integrated

A30730	SI Motion P2: Reference block for dynamic Safely-Limited Speed invalid
Reaction:	NONE
Acknowledge:	NONE
Cause:	The reference block transferred via PROFIsafe is negative. A reference block is used to generate a referred velocity limit value based on the reference quantity "Velocity limit value SLS1" (p9531[0]). The drive is stopped by the configured stop response (p9563[0]). Message value (r2124, interpret decimal): requested, invalid reference block.
Remedy:	In the PROFIsafe telegram, input data S_SLS_LIMIT_IST must be corrected. This message can be acknowledged without a POWER ON as follows (safe acknowledgment): - PROFIsafe. Note: SI: Safety Integrated SLS: Safely-Limited Speed

A30788	Automatic test stop: wait for STO deselection via SMM
Reaction:	NONE
Acknowledge:	NONE
Cause:	The automatic test stop was not able to be carried out after powering up. Possible causes: - the STO function is selected via Safety Extended Functions. - a safety message is present, that resulted in a STO. Note: STO: Safe Torque Off
Remedy:	- Deselect STO via Safety Extended Functions. - remove the cause of the safety messages and acknowledge the messages. Note: The automatic test stop is performed after removing the cause.

A30798	SI Motion P2: Test stop for motion monitoring functions running
Reaction:	NONE
Acknowledge:	NONE
Cause:	The forced checking procedure (test stop) for the safe motion monitoring functions is currently in progress.

15.2 List of faults and alarms

Remedy: Not necessary.
The message is automatically withdrawn when the test stop has been completed.
Note:
SI: Safety Integrated

A30799 SI Motion P2: Acceptance test mode active

Reaction: NONE
Acknowledge: NONE
Cause: The acceptance test mode is active.
This means that the setpoint speed limiting is deactivated (r9733).
Remedy: Not necessary.
The message is automatically withdrawn when exiting the acceptance test mode.
Note:
SI: Safety Integrated

N30800 Power unit: Group signal

Reaction: OFF2
Acknowledge: NONE
Cause: The power unit has detected at least one fault.
Remedy: Evaluate the other messages that are presently available.

F30805 Power unit: EEPROM checksum error

Reaction: OFF2
Acknowledge: IMMEDIATELY
Cause: Internal parameter data is corrupted.
Fault value (r0949, interpret hexadecimal):
01: EEPROM access error.
02: Too many blocks in the EEPROM.
Remedy: Replace the module.

F30895 power module DRIVE-CLiQ: Alternating cyclic data transfer error

Reaction: OFF2
Acknowledge: IMMEDIATELY
Cause: A DRIVE-CLiQ communication error has occurred from the power unit to the Control Unit involved.
Fault cause:
11 (= 0B hex):
Synchronization error during alternating cyclic data transfer.
Note regarding the message value:
The individual information is coded as follows in the message value (r0949/r2124):
0000yyxx hex: yy = component number, xx = error cause
Remedy: Carry out a POWER ON (switch-off/switch-on).

F30899 Power unit: Unknown fault

Reaction: NONE
Acknowledge: IMMEDIATELY

Cause: A fault occurred on the power unit that cannot be interpreted by the Control Unit firmware.
 This can occur if the firmware on this component is more recent than the firmware on the Control Unit.
 Fault value (r0949, interpret decimal):
 Fault number.
 Note:
 If required, the significance of this new fault can be read about in a more recent description of the Control Unit.

Remedy:

- replace the firmware on the power unit by an older firmware version (r0128).
- upgrade the firmware on the Control Unit (r0018).

F30950 Power unit: Internal software error

Reaction: OFF2
Acknowledge: POWER ON
Cause: An internal software error has occurred.
 Fault value (r0949, interpret decimal):
 Information about the fault source.
 Only for internal Siemens troubleshooting.

Remedy:

- if necessary, upgrade the firmware in the power unit to a later version.
- contact Technical Support.

A30999 Power unit: Unknown alarm

Reaction: NONE
Acknowledge: NONE
Cause: An alarm occurred on the power unit that cannot be interpreted by the Control Unit firmware.
 This can occur if the firmware on this component is more recent than the firmware on the Control Unit.
 Alarm value (r2124, interpret decimal):
 Alarm number.
 Note:
 If required, the significance of this new alarm can be read about in a more recent description of the Control Unit.

Remedy:

- replace the firmware on the power unit by an older firmware version (r0128).
- upgrade the firmware on the Control Unit (r0018).

F31120 Encoder 1: Encoder power supply fault

Reaction: ENCODER
Acknowledge: PULSE INHIBIT
Cause: An encoder power supply fault was detected.
 Fault value (r0949, interpret binary):
 Bit 0: Undervoltage condition on the sense line.
 Bit 1: Overcurrent condition for the encoder power supply.
 Bit 2: Overcurrent condition for encoder power supply on cable resolver excitation negative.
 Bit 3: Overcurrent condition for encoder power supply on cable resolver excitation positive.
 Bit 4: The 24 V power supply through the Power Module (PM) is overloaded.
 Bit 5: Overcurrent at the EnDat connection of the converter.
 Bit 6: Overvoltage at the EnDat connection of the converter.
 Bit 7: Hardware fault at the EnDat connection of the converter.
 Note:
 If the encoder cables 6FX2002-2EQ00-.... and 6FX2002-2CH00-.... are interchanged, this can result in the encoder being destroyed because the pins of the operating voltage are reversed.

15.2 List of faults and alarms

- Remedy:**
- For fault value, bit 0 = 1:
 - correct encoder cable connected?
 - check the plug connections of the encoder cable.
 - SMC30: Check the parameterization (p0404.22).
 - For fault value, bit 1 = 1:
 - correct encoder cable connected?
 - replace the encoder or encoder cable.
 - For fault value, bit 2 = 1:
 - correct encoder cable connected?
 - replace the encoder or encoder cable.
 - For fault value, bit 3 = 1:
 - correct encoder cable connected?
 - replace the encoder or encoder cable.
 - For fault value, bit 5 = 1:
 - Measuring unit correctly connected at the converter?
 - Replace the measuring unit or the cable to the measuring unit.
 - For fault value, bit 6, 7 = 1:
 - Replace the defective EnDat 2.2 converter.

F31135	Encoder 1: Fault when determining the position (single turn)
Reaction:	ENCODER
Acknowledge:	PULSE INHIBIT

Cause: The encoder has identified a position determination fault (singleturn) and supplies status information bit by bit in an internal status/fault word.
 Some of these bits cause this fault to be triggered. Other bits are status displays. The status/fault word is displayed in the fault value.
 Note regarding the bit designation:
 The first designation is valid for DRIVE-CLiQ encoders, the second for EnDat 2.2 encoders.
 Fault value (r0949, interpret binary):
 Bit 0: F1 (safety status display).
 Bit 1: F2 (safety status display).
 Bit 2: Reserved (lighting).
 Bit 3: Reserved (signal amplitude).
 Bit 4: Reserved (position value).
 Bit 5: Reserved (overvoltage).
 Bit 6: Reserved (undervoltage)/hardware fault EnDat supply (--> F3x110, x = 1, 2, 3).
 Bit 7: Reserved (overcurrent)/EnDat encoder withdrawn when not in the parked state (--> F3x110, x = 1, 2, 3).
 Bit 8: Reserved (battery)/overcurrent EnDat supply (--> F3x110, x = 1, 2, 3).
 Bit 9: Reserved/overvoltage EnDat supply (--> F3x110, x = 1, 2, 3).
 Bit 11: Reserved/internal communication error (--> F3x110, x = 1, 2, 3).
 Bit 12: Reserved/internal communication error (--> F3x110, x = 1, 2, 3).
 Bit 13: Reserved/internal communication error (--> F3x110, x = 1, 2, 3).
 Bit 14: Reserved/internal communication error (--> F3x110, x = 1, 2, 3).
 Bit 15: Internal communication error (--> F3x110, x = 1, 2, 3).
 Bit 16: Lighting (--> F3x135, x = 1, 2, 3).
 Bit 17: Signal amplitude (--> F3x135, x = 1, 2, 3).
 Bit 18: Singleturn position 1 (--> F3x135, x = 1, 2, 3).
 Bit 19: Overvoltage (--> F3x135, x = 1, 2, 3).
 Bit 20: Undervoltage (--> F3x135, x = 1, 2, 3).
 Bit 21: Overcurrent (--> F3x135, x = 1, 2, 3).
 Bit 22: Temperature exceeded (--> F3x405, x = 1, 2, 3).
 Bit 23: Singleturn position 2 (safety status display).
 Bit 24: Singleturn system (--> F3x135, x = 1, 2, 3).
 Bit 25: Singleturn power down (--> F3x135, x = 1, 2, 3).
 Bit 26: Multiturn position 1 (--> F3x136, x = 1, 2, 3).
 Bit 27: Multiturn position 2 (--> F3x136, x = 1, 2, 3).
 Bit 28: Multiturn system (--> F3x136, x = 1, 2, 3).
 Bit 29: Multiturn power down (--> F3x136, x = 1, 2, 3).
 Bit 30: Multiturn overflow/underflow (--> F3x136, x = 1, 2, 3).
 Bit 31: Multiturn battery (reserved).

Remedy: - determine the detailed cause of the fault using the fault value.
 - replace the encoder if necessary.
 Note:
 An EnDat 2.2 encoder may only be removed and inserted in the "Park" state.
 If an EnDat 2.2 encoder was removed when not in the "Park" state, then after inserting the encoder, a POWER ON (switch-off/switch-on) is necessary to acknowledge the fault.

F31136 Encoder 1: Fault when determining the position (multiturn)
Reaction: ENCODER
Acknowledge: PULSE INHIBIT

15.2 List of faults and alarms

Cause: The encoder has identified a position determination fault (multiturn) and supplies status information bit by bit in an internal status/fault word.

Some of these bits cause this fault to be triggered. Other bits are status displays. The status/fault word is displayed in the fault value.

Note regarding the bit designation:

The first designation is valid for DRIVE-CLiQ encoders, the second for EnDat 2.2 encoders.

Fault value (r0949, interpret binary):

Bit 0: F1 (safety status display).

Bit 1: F2 (safety status display).

Bit 2: Reserved (lighting).

Bit 3: Reserved (signal amplitude).

Bit 4: Reserved (position value).

Bit 5: Reserved (overvoltage).

Bit 6: Reserved (undervoltage)/hardware fault EnDat supply (--> F3x110, x = 1, 2, 3).

Bit 7: Reserved (overcurrent)/EnDat encoder withdrawn when not in the parked state (--> F3x110, x = 1, 2, 3).

Bit 8: Reserved (battery)/overcurrent EnDat supply (--> F3x110, x = 1, 2, 3).

Bit 9: Reserved/overvoltage EnDat supply (--> F3x110, x = 1, 2, 3).

Bit 11: Reserved/internal communication error (--> F3x110, x = 1, 2, 3).

Bit 12: Reserved/internal communication error (--> F3x110, x = 1, 2, 3).

Bit 13: Reserved/internal communication error (--> F3x110, x = 1, 2, 3).

Bit 14: Reserved/internal communication error (--> F3x110, x = 1, 2, 3).

Bit 15: Internal communication error (--> F3x110, x = 1, 2, 3).

Bit 16: Lighting (--> F3x135, x = 1, 2, 3).

Bit 17: Signal amplitude (--> F3x135, x = 1, 2, 3).

Bit 18: Singleturn position 1 (--> F3x135, x = 1, 2, 3).

Bit 19: Overvoltage (--> F3x135, x = 1, 2, 3).

Bit 20: Undervoltage (--> F3x135, x = 1, 2, 3).

Bit 21: Overcurrent (--> F3x135, x = 1, 2, 3).

Bit 22: Temperature exceeded (--> F3x405, x = 1, 2, 3).

Bit 23: Singleturn position 2 (safety status display).

Bit 24: Singleturn system (--> F3x135, x = 1, 2, 3).

Bit 25: Singleturn power down (--> F3x135, x = 1, 2, 3).

Bit 26: Multiturn position 1 (--> F3x136, x = 1, 2, 3).

Bit 27: Multiturn position 2 (--> F3x136, x = 1, 2, 3).

Bit 28: Multiturn system (--> F3x136, x = 1, 2, 3).

Bit 29: Multiturn power down (--> F3x136, x = 1, 2, 3).

Bit 30: Multiturn overflow/underflow (--> F3x136, x = 1, 2, 3).

Bit 31: Multiturn battery (reserved).

Remedy: - determine the detailed cause of the fault using the fault value.

- replace the encoder if necessary.

Note:

An EnDat 2.2 encoder may only be removed and inserted in the "Park" state.

If an EnDat 2.2 encoder was removed when not in the "Park" state, then after inserting the encoder, a POWER ON (switch-off/switch-on) is necessary to acknowledge the fault.

F31137 Encoder 1: Fault when determining the position (single turn)

Reaction: ENCODER

Acknowledge: PULSE INHIBIT

Cause: A position determination fault has occurred in the DRIVE-CLiQ encoder.
 Fault value (r0949, interpret binary):
 yyxxxxx hex: yy = encoder version, xxxxxx = bit coding of the fault cause

 For yy = 8 (0000 1000 bin), the following applies:
 Bit 1: Signal monitoring (sin/cos).
 Bit 8: F1 (safety status display) error position word 1.
 Bit 9: F2 (safety status display) error position word 2.
 Bit 16: LED monitoring.
 Bit 17: Fault when determining the position (multiturn).
 Bit 23: Temperature outside the limit values.

 For yy = 11 (0000 1011 bin), the following applies:
 Bit 0: Position word 1 difference between rotation counter and software counter (XC_ERR).
 Bit 1: Position word 1 track error of the incremental signals (LIS_ERR).
 Bit 2: Position word 1 error when aligning between incremental track signals and absolute value (ST_ERR).
 Bit 3: Maximum permissible temperature exceeded (TEMP_ERR).
 Bit 4: Power supply overvoltage (MON_OVR_VOLT).
 Bit 5: Power supply overcurrent (MON_OVR_CUR).
 Bit 6: Power supply undervoltage (MON_UND_VOLT).
 Bit 7: Rotation error counter (MT_ERR).
 Bit 8: F1 (safety status display) error position word 1.
 Bit 9: F2 (safety status display) error position word 2.
 Bit 11: Position word 1 status bit: singleturn position OK (ADC_ready).
 Bit 12: Position word 1 status bit: rotation counter OK (MT_ready).
 Bit 13: Position word 1 memory error (MEM_ERR).
 Bit 14: Position word 1 absolute position error (MLS_ERR).
 Bit 15: position word 1 LED error, lighting unit error (LED_ERR).
 Bit 18: Position word 2 error when aligning between incremental track signals and absolute value (ST_ERR).
 Bit 21: Position word 2 memory error (MEM_ERR).
 Bit 22: Position word 2 absolute position error (MLS_ERR).
 Bit 23: position word 2 LED error, lighting unit error (LED_ERR).

 For yy = 12 (0000 1100 bin), the following applies:
 Bit 8: encoder fault.
 Bit 10: error in the internal position data transport.

 For yy = 14 (0000 1110 bin), the following applies:
 Bit 0: Position word 1 temperature outside limit value.
 Bit 1: Position word 1 position determination error (multiturn).
 Bit 2: Position word 1 FPGA error.
 Bit 3: Position word 1 velocity error.
 Bit 4: Position word 1 communication error between FPGAs/error in the incremental signal.
 Bit 5: Position word 1 timeout absolute value/error when determining the position (singleturn).
 Bit 6: Position word 1 internal hardware fault (clock/power monitor IC/power).
 Bit 7: Position word 1 internal error (FPGA communication/FPGA parameterization/self-test/software).
 Bit 8: F1 (safety status display) error position word 1.
 Bit 9: F2 (safety status display) error position word 2.
 Bit 16: Position word 2 temperature outside limit value.
 Bit 17: Position word 2 position determination error (multiturn).
 Bit 18: Position word 2 FPGA error.
 Bit 19: Position word 2 velocity error.

15.2 List of faults and alarms

- Bit 20: Position word 2 communication error between FPGAs.
- Bit 21: Position word 2 position determination error (singleturn).
- Bit 22: Position word 2 internal hardware fault (clock/power monitor IC/power).
- Bit 23: Position word 2 internal error (self-test/software).

Note:

For an encoder version that is not described here, please contact the encoder manufacturer for more detailed information on the bit coding.

- Remedy:**
- determine the detailed cause of the fault using the fault value.
 - if required, replace the DRIVE-CLiQ encoder.

F31138 Encoder 1: Fault when determining the position (multiturn)

Reaction: ENCODER

Acknowledge: PULSE INHIBIT

Cause: A position determination fault has occurred in the DRIVE-CLiQ encoder.
 Fault value (r0949, interpret binary):
 yyxxxxxx hex: yy = encoder version, xxxxxx = bit coding of the fault cause

 For yy = 8 (0000 1000 bin), the following applies:
 Bit 1: Signal monitoring (sin/cos).
 Bit 8: F1 (safety status display) error position word 1.
 Bit 9: F2 (safety status display) error position word 2.
 Bit 16: LED monitoring.
 Bit 17: Fault when determining the position (multiturn).
 Bit 23: Temperature outside the limit values.

 For yy = 11 (0000 1011 bin), the following applies:
 Bit 0: Position word 1 difference between rotation counter and software counter (XC_ERR).
 Bit 1: Position word 1 track error of the incremental signals (LIS_ERR).
 Bit 2: Position word 1 error when aligning between incremental track signals and absolute value (ST_ERR).
 Bit 3: Maximum permissible temperature exceeded (TEMP_ERR).
 Bit 4: Power supply overvoltage (MON_OVR_VOLT).
 Bit 5: Power supply overcurrent (MON_OVR_CUR).
 Bit 6: Power supply undervoltage (MON_UND_VOLT).
 Bit 7: Rotation error counter (MT_ERR).
 Bit 8: F1 (safety status display) error position word 1.
 Bit 9: F2 (safety status display) error position word 2.
 Bit 11: Position word 1 status bit: singleturn position OK (ADC_ready).
 Bit 12: Position word 1 status bit: rotation counter OK (MT_ready).
 Bit 13: Position word 1 memory error (MEM_ERR).
 Bit 14: Position word 1 absolute position error (MLS_ERR).
 Bit 15: position word 1 LED error, lighting unit error (LED_ERR).
 Bit 18: Position word 2 error when aligning between incremental track signals and absolute value (ST_ERR).
 Bit 21: Position word 2 memory error (MEM_ERR).
 Bit 22: Position word 2 absolute position error (MLS_ERR).
 Bit 23: position word 2 LED error, lighting unit error (LED_ERR).

 For yy = 14 (0000 1110 bin), the following applies:
 Bit 0: Position word 1 temperature outside limit value.
 Bit 1: Position word 1 position determination error (multiturn).
 Bit 2: Position word 1 FPGA error.
 Bit 3: Position word 1 velocity error.
 Bit 4: Position word 1 communication error between FPGAs/error in the incremental signal.
 Bit 5: Position word 1 timeout absolute value/error when determining the position (singleturn).
 Bit 6: Position word 1 internal hardware fault (clock/power monitor IC/power).
 Bit 7: Position word 1 internal error (FPGA communication/FPGA parameterization/self-test/software).
 Bit 8: F1 (safety status display) error position word 1.
 Bit 9: F2 (safety status display) error position word 2.
 Bit 16: Position word 2 temperature outside limit value.
 Bit 17: Position word 2 position determination error (multiturn).
 Bit 18: Position word 2 FPGA error.
 Bit 19: Position word 2 velocity error.
 Bit 20: Position word 2 communication error between FPGAs.
 Bit 21: Position word 2 position determination error (singleturn).
 Bit 22: Position word 2 internal hardware fault (clock/power monitor IC/power).
 Bit 23: Position word 2 internal error (self-test/software).

15.2 List of faults and alarms

Note:

For an encoder version that is not described here, please contact the encoder manufacturer for more detailed information on the bit coding.

Remedy: - determine the detailed cause of the fault using the fault value.
- if required, replace the DRIVE-CLiQ encoder.

F31405 Encoder 1: Temperature in the encoder evaluation exceeded

Reaction: ENCODER

Acknowledge: IMMEDIATELY

Cause: An inadmissibly high temperature was detected in the encoder electronics or the encoder evaluation.
Fault value (r0949, interpret hexadecimal):
yyxxxx hex: yy = temperature sensor number, xxxx = measured module temperature in 0.1 °C.

Remedy: Reduce the ambient temperature for the DRIVE-CLiQ connection of the motor.

A31700 Encoder 1: Functional safety monitoring initiated

Reaction: NONE

Acknowledge: NONE

Cause: Functional safety was activated. Self-test of the DRIVE-CLiQ encoder has detected a fault.
Alarm value (r2124, interpret binary):
Bit x = 1: Effectivity test x unsuccessful.

Remedy: Replace encoder.

F31801 Encoder 1 DRIVE-CLiQ: Sign-of-life missing

Reaction: ENCODER

Acknowledge: IMMEDIATELY

Cause: A DRIVE-CLiQ communication error has occurred from the Control Unit to the encoder involved.
Fault cause:
10 (= 0A hex):
The sign-of-life bit in the receive telegram is not set.
Note regarding the message value:
The individual information is coded as follows in the message value (r0949/r2124):
0000yyxx hex: yy = component number, xx = error cause

Remedy: - check the electrical cabinet design and cable routing for EMC compliance
- replace the component involved.

F31802 Encoder 1: Time slice overflow

Reaction: ENCODER

Acknowledge: IMMEDIATELY

Cause: A time slice overflow has occurred in encoder 1.
Fault value (r0949, interpret hexadecimal):
yx hex: y = function involved (Siemens-internal fault diagnostics), x = time slice involved
x = 9:
Time slice overflow of the fast (current controller clock cycle) time slice.
x = A:
Time slice overflow of the average time slice.
x = C:
Time slice overflow of the slow time slice.
yx = 3E7:
Timeout when waiting for SYNO (e.g. unexpected return to non-cyclic operation).

Remedy: Increase the current controller sampling time
Note:
 For a current controller sampling time = 31.25 μ s, use an SMx20 with Article No. 6SL3055-0AA00-5xA3.

F31804 Encoder 1: Sensor Module checksum error

Reaction: ENCODER

Acknowledge: POWER ON

Cause: A checksum error has occurred when reading-out the program memory on the Sensor Module.

Fault value (r0949, interpret hexadecimal):

yyyyxxxx hex

yyyy: Memory area involved.

xxxx: Difference between the checksum at POWER ON and the actual checksum.

Remedy:

- carry out a POWER ON (switch-off/switch-on).
- upgrade firmware to later version (\geq V2.6 HF3, \geq V4.3 SP2, \geq V4.4).
- check whether the permissible ambient temperature for the component is maintained.
- replace the Sensor Module.

F31805 Encoder 1: EEPROM checksum error

Reaction: ENCODER

Acknowledge: IMMEDIATELY

Cause: Data in the EEPROM corrupted .

Fault value (r0949, interpret hexadecimal):

01: EEPROM access error.

02: Too many blocks in the EEPROM.

Remedy: Replace the module.

F31806 Encoder 1: Initialization error

Reaction: ENCODER

Acknowledge: PULSE INHIBIT

15.2 List of faults and alarms

Cause: The encoder was not successfully initialized.
Fault value (r0949, interpret binary):
Bit 0, 1: Encoder initialization with the motor rotating has failed (deviation involving coarse and fine position in encoder pulses/4).
Bit 2: Mid-voltage matching for track A unsuccessful.
Bit 3: Mid-voltage matching for track B unsuccessful.
Bit 4: Mid-voltage matching for acceleration input unsuccessful.
Bit 5: Mid-voltage matching for track safety A unsuccessful.
Bit 6: Mid-voltage matching for track safety B unsuccessful.
Bit 7: Mid-voltage matching for track C unsuccessful.
Bit 8: Mid-voltage matching for track D unsuccessful.
Bit 9: Mid-voltage matching for track R unsuccessful.
Bit 10: The difference in mid-voltages between A and B is too great (> 0.5 V)
Bit 11: The difference in mid-voltages between C and D is too great (> 0.5 V)
Bit 12: The difference in mid-voltages between safety A and safety B is too great (> 0.5 V)
Bit 13: The difference in mid-voltages between A and safety B is too great (> 0.5 V)
Bit 14: The difference in mid-voltages between B and safety A is too great (> 0.5 V)
Bit 15: The standard deviation of the calculated mid-voltages is too great (> 0.3 V)
Bit 16: Internal fault - fault when reading a register (CAFE)
Bit 17: Internal fault - fault when writing a register (CAFE)
Bit 18: Internal fault: No mid-voltage matching available
Bit 19: Internal error - ADC access error.
Bit 20: Internal error - no zero crossover found.
Bit 28: Error while initializing the EnDat 2.2 measuring unit.
Bit 29: Error when reading out the data from the EnDat 2.2 measuring unit.
Bit 30: EEPROM checksum of the EnDat 2.2 measuring unit incorrect.
Bit 31: Data of the EnDat 2.2 measuring unit inconsistent.
Note:
Bit 0, 1: Up to 6SL3055-0AA00-5*A0
Bits 2 ... 20: 6SL3055-0AA00-5*A1 and higher

Remedy: Acknowledge fault.
If the fault cannot be acknowledged:
Bits 2 ... 9: Check encoder power supply.
Bits 2 ... 14: Check the corresponding cable.
Bit 15 with no other bits: Check track R, check settings in p0404.
Bit 28: Check the cable between the EnDat 2.2 converter and the measuring unit.
Bit 29 ... 31: Replace the defective measuring unit.

F31813 Encoder 1: Hardware logic unit failed

Reaction: ENCODER
Acknowledge: PULSE INHIBIT
Cause: The logic unit of the DRIVE-CLiQ encoder has failed.
Fault value (r0949, interpret binary):
Bit 0: ALU watchdog has responded.
Bit 1: ALU has detected a sign-of-life error.
Remedy: When the error reoccurs, replace the encoder.

F31820 Encoder 1 DRIVE-CLiQ: Telegram error

Reaction: ENCODER
Acknowledge: IMMEDIATELY

Cause: A DRIVE-CLiQ communication error has occurred from the Control Unit to the encoder concerned.

Fault cause:

1 (= 01 hex):

Checksum error (CRC error).

2 (= 02 hex):

Telegram is shorter than specified in the length byte or in the receive list.

3 (= 03 hex):

Telegram is longer than specified in the length byte or in the receive list.

4 (= 04 hex):

The length of the receive telegram does not match the receive list.

5 (= 05 hex):

The type of the receive telegram does not match the receive list.

6 (= 06 hex):

The address of the component in the telegram and in the receive list do not match.

7 (= 07 hex):

A SYNC telegram is expected - but the received telegram is not a SYNC telegram.

8 (= 08 hex):

No SYNC telegram is expected - but the received telegram is one.

9 (= 09 hex):

The error bit in the receive telegram is set.

16 (= 10 hex):

The receive telegram is too early.

Note regarding the message value:

The individual information is coded as follows in the message value (r0949/r2124):

0000yyxx hex: yy = component number, xx = error cause

Remedy:

- carry out a POWER ON (switch-off/switch-on).

- check the electrical cabinet design and cable routing for EMC compliance

- check the DRIVE-CLiQ wiring (interrupted cable, contacts, ...).

F31835 Encoder 1 DRIVE-CLiQ: Cyclic data transfer error

Reaction: ENCODER

Acknowledge: IMMEDIATELY

Cause: A DRIVE-CLiQ communication error has occurred from the Control Unit to the encoder concerned. The nodes do not send and receive in synchronism.

Fault cause:

33 (= 21 hex):

The cyclic telegram has not been received.

34 (= 22 hex):

Timeout in the telegram receive list.

64 (= 40 hex):

Timeout in the telegram send list.

Note regarding the message value:

The individual information is coded as follows in the message value (r0949/r2124):

0000yyxx hex: yy = component number, xx = error cause

Remedy:

- carry out a POWER ON.

- replace the component involved.

F31836 Encoder 1 DRIVE-CLiQ: Send error for DRIVE-CLiQ data

Reaction: ENCODER

Acknowledge: IMMEDIATELY

15.2 List of faults and alarms

Cause: A DRIVE-CLiQ communication error has occurred from the Control Unit to the encoder involved. Data were not able to be sent.
Fault cause:
65 (= 41 hex):
Telegram type does not match send list.
Note regarding the message value:
The individual information is coded as follows in the message value (r0949/r2124):
0000yyxx hex: yy = component number, xx = error cause

Remedy: Carry out a POWER ON.

F31837 Encoder 1 DRIVE-CLiQ: Component fault

Reaction: ENCODER

Acknowledge: IMMEDIATELY

Cause: Fault detected on the DRIVE-CLiQ component concerned. Faulty hardware cannot be excluded.

Fault cause:
32 (= 20 hex):
Error in the telegram header.
35 (= 23 hex):
Receive error: The telegram buffer memory contains an error.
66 (= 42 hex):
Send error: The telegram buffer memory contains an error.
67 (= 43 hex):
Send error: The telegram buffer memory contains an error.
Note regarding the message value:
The individual information is coded as follows in the message value (r0949/r2124):
0000yyxx hex: yy = component number, xx = error cause

Remedy:

- check the DRIVE-CLiQ wiring (interrupted cable, contacts, ...).
- check the electrical cabinet design and cable routing for EMC compliance
- if required, use another DRIVE-CLiQ socket (p9904).
- replace the component involved.

F31845 Encoder 1 DRIVE-CLiQ: Cyclic data transfer error

Reaction: ENCODER

Acknowledge: IMMEDIATELY

Cause: A DRIVE-CLiQ communication error has occurred from the Control Unit to the encoder involved.

Fault cause:
11 (= 0B hex):
Synchronization error during alternating cyclic data transfer.
Note regarding the message value:
The individual information is coded as follows in the message value (r0949/r2124):
0000yyxx hex: yy = component number, xx = error cause

Remedy: Carry out a POWER ON (switch-off/switch-on).

F31850 Encoder 1: Encoder evaluation internal software error

Reaction: ENCODER

Acknowledge: POWER ON

Cause: An internal software error has occurred in the Sensor Module of encoder 1.
 Fault value (r0949, interpret decimal):
 1: Background time slice is blocked.
 2: Checksum over the code memory is not OK.
 10000: OEM memory of the EnDat encoder contains data that cannot be interpreted.
 11000 ... 11499: Descriptive data from EEPROM incorrect.
 11500 ... 11899: Calibration data from EEPROM incorrect.
 11900 ... 11999: Configuration data from EEPROM incorrect.
 12000 ... 12008: communication with analog/digital converter faulted.
 16000: DRIVE-CLiQ encoder initialization application error.
 16001: DRIVE-CLiQ encoder initialization ALU error.
 16002: DRIVE-CLiQ encoder HISI / SISl initialization error.
 16003: DRIVE-CLiQ encoder safety initialization error.
 16004: DRIVE-CLiQ encoder internal system error.

Remedy:

- replace the Sensor Module.
- if required, upgrade the firmware in the Sensor Module.
- contact Technical Support.

F31851 Encoder 1 DRIVE-CLiQ (CU): Sign-of-life missing

Reaction: ENCODER
Acknowledge: IMMEDIATELY
Cause: A DRIVE-CLiQ communication error has occurred from the Sensor Module (encoder 1) involved to the Control Unit.
 The DRIVE-CLiQ component did not set the sign-of-life to the Control Unit.
 Fault cause:
 10 (= 0A hex):
 The sign-of-life bit in the receive telegram is not set.
 Note regarding the message value:
 The individual information is coded as follows in the message value (r0949/r2124):
 0000yyxx hex: yy = component number, xx = error cause

Remedy:

- Upgrade the firmware of the component involved.
- carry out a POWER ON (switch-off/switch-on) for the component involved.

F31860 Encoder 1 DRIVE-CLiQ (CU): Telegram error

Reaction: ENCODER
Acknowledge: IMMEDIATELY

15.2 List of faults and alarms

Cause: A DRIVE-CLiQ communication error has occurred from the Sensor Module (encoder 1) involved to the Control Unit.
Fault cause:
1 (= 01 hex):
Checksum error (CRC error).
2 (= 02 hex):
Telegram is shorter than specified in the length byte or in the receive list.
3 (= 03 hex):
Telegram is longer than specified in the length byte or in the receive list.
4 (= 04 hex):
The length of the receive telegram does not match the receive list.
5 (= 05 hex):
The type of the receive telegram does not match the receive list.
6 (= 06 hex):
The address of the power unit in the telegram and in the receive list do not match.
9 (= 09 hex):
The DRIVE-CLiQ communication from the DRIVE-CLiQ component involved to the Control Unit signals that the supply voltage has failed.
16 (= 10 hex):
The receive telegram is too early.
17 (= 11 hex):
CRC error and the receive telegram is too early.
18 (= 12 hex):
The telegram is shorter than that specified in the length byte or in the receive list and the receive telegram is too early.
19 (= 13 hex):
The telegram is longer than that specified in the length byte or in the receive list and the receive telegram is too early.
20 (= 14 hex):
The length of the receive telegram does not match the receive list and the receive telegram is too early.
21 (= 15 hex):
The type of the receive telegram does not match the receive list and the receive telegram is too early.
22 (= 16 hex):
The address of the power unit in the telegram and in the receive list does not match and the receive telegram is too early.
25 (= 19 hex):
The error bit in the receive telegram is set and the receive telegram is too early.
Note regarding the message value:
The individual information is coded as follows in the message value (r0949/r2124):
0000yyxx hex: yy = component number, xx = error cause

Remedy:

- carry out a POWER ON (switch-off/switch-on).
- check the electrical cabinet design and cable routing for EMC compliance
- check the DRIVE-CLiQ wiring (interrupted cable, contacts, ...).

F31875 Encoder 1: power supply voltage failed

Reaction: ENCODER

Acknowledge: IMMEDIATELY

Cause: The DRIVE-CLiQ communication from the DRIVE-CLiQ component involved to the Control Unit signals that the supply voltage has failed.

Fault cause:

9 (= 09 hex):

The power supply voltage for the components has failed.

Note regarding the message value:

The individual information is coded as follows in the message value (r0949/r2124):

0000yyxx hex: yy = component number, xx = error cause

- Remedy:**
- carry out a POWER ON (switch-off/switch-on).
 - check the power supply voltage wiring for the DRIVE-CLiQ component (interrupted cable, contacts, ...).
 - check the dimensioning of the power supply for the DRIVE-CLiQ component.

F31885 Encoder 1 DRIVE-CLiQ (CU): Cyclic data transfer error

Reaction: ENCODER

Acknowledge: IMMEDIATELY

Cause: A DRIVE-CLiQ communication error has occurred from the Sensor Module (encoder 1) involved to the Control Unit. The nodes do not send and receive in synchronism.

Fault cause:

26 (= 1A hex):

Sign-of-life bit in the receive telegram not set and the receive telegram is too early.

33 (= 21 hex):

The cyclic telegram has not been received.

34 (= 22 hex):

Timeout in the telegram receive list.

64 (= 40 hex):

Timeout in the telegram send list.

98 (= 62 hex):

Error at the transition to cyclic operation.

Note regarding the message value:

The individual information is coded as follows in the message value (r0949/r2124):

0000yyxx hex: yy = component number, xx = error cause

- Remedy:**
- check the power supply voltage of the component involved.
 - carry out a POWER ON.
 - replace the component involved.

F31886 Encoder 1 DRIVE-CLiQ (CU): Error when sending DRIVE-CLiQ data

Reaction: ENCODER

Acknowledge: IMMEDIATELY

Cause: A DRIVE-CLiQ communication error has occurred from the Sensor Module (encoder 1) involved to the Control Unit. Data were not able to be sent.

Fault cause:

65 (= 41 hex):

Telegram type does not match send list.

Note regarding the message value:

The individual information is coded as follows in the message value (r0949/r2124):

0000yyxx hex: yy = component number, xx = error cause

- Remedy:**
- carry out a POWER ON.
 - check whether the firmware version of the encoder (r0148) matches the firmware version of Control Unit (r0018).

F31887 Encoder 1 DRIVE-CLiQ (CU): Component fault

Reaction: ENCODER

Acknowledge: IMMEDIATELY

15.2 List of faults and alarms

Cause: Fault detected on the DRIVE-CLiQ component involved (Sensor Module for encoder 1). Faulty hardware cannot be excluded.
Fault cause:
32 (= 20 hex):
Error in the telegram header.
35 (= 23 hex):
Receive error: The telegram buffer memory contains an error.
66 (= 42 hex):
Send error: The telegram buffer memory contains an error.
67 (= 43 hex):
Send error: The telegram buffer memory contains an error.
96 (= 60 hex):
Response received too late during runtime measurement.
97 (= 61 hex):
Time taken to exchange characteristic data too long.
Note regarding the message value:
The individual information is coded as follows in the message value (r0949/r2124):
0000yyxx hex: yy = component number, xx = error cause

Remedy:

- check the DRIVE-CLiQ wiring (interrupted cable, contacts, ...).
- check the electrical cabinet design and cable routing for EMC compliance
- if required, use another DRIVE-CLiQ socket (p9904).
- replace the component involved.

F31895 Encoder 1 DRIVE-CLiQ (CU): Alternating cyclic data transfer error

Reaction: ENCODER
Acknowledge: IMMEDIATELY
Cause: A DRIVE-CLiQ communication error has occurred from the Sensor Module (encoder 1) involved to the Control Unit.
Fault cause:
11 (= 0B hex):
Synchronization error during alternating cyclic data transfer.
Note regarding the message value:
The individual information is coded as follows in the message value (r0949/r2124):
0000yyxx hex: yy = component number, xx = error cause

Remedy: Carry out a POWER ON.

F31896 Encoder 1 DRIVE-CLiQ (CU): Inconsistent component properties

Reaction: OFF2
Acknowledge: IMMEDIATELY
Cause: The properties of the DRIVE-CLiQ component (Sensor Module for encoder 1), specified by the fault value, have changed in an incompatible fashion with respect to the properties when booted. One cause can be, e.g. that a DRIVE-CLiQ cable or DRIVE-CLiQ component has been replaced.
Fault value (r0949, interpret decimal):
Component number.

Remedy:

- carry out a POWER ON.
- when a component is replaced, the same component type and if possible the same firmware version should be used.
- when a cable is replaced, only cables whose length is the same as or as close as possible to the length of the original cables should be used (ensure compliance with the maximum cable length).

F31950 Encoder 1: Internal software error

Reaction: ENCODER
Acknowledge: POWER ON

Cause: An internal software error has occurred.
 Fault value (r0949, interpret decimal):
 The fault value contains information regarding the fault source.
 Only for internal Siemens troubleshooting.

Remedy: - if necessary, upgrade the firmware in the Sensor Module to a later version.
 - contact Technical Support.

F40000 **Fault at DRIVE-CLiQ socket X100**

Reaction: NONE

Acknowledge: IMMEDIATELY

Cause: A fault has occurred at the drive object at the DRIVE-CLiQ socket X100.
 Fault value (r0949, interpret decimal):
 First fault that has occurred for this drive object.

Remedy: Evaluate the fault buffer of the specified object.

A40100 **Alarm at DRIVE-CLiQ socket X100**

Reaction: NONE

Acknowledge: NONE

Cause: An alarm has occurred at the drive object at the DRIVE-CLiQ socket X100.
 Alarm value (r2124, interpret decimal):
 First alarm that has occurred for this drive object.

Remedy: Evaluate the alarm buffer of the specified object.

Appendix

A.1 Communication telegrams

The converter supports a standard telegram with two supplementary telegrams and a PROFIsafe telegram.

The bit assignments of the individual process data can be found in the following Section:

 Bit assignments of the process data (Page 542)

A.1.1 Standard telegrams

The telegrams are suitable for IRT communication. Telegrams 3 and 102 are also suitable for RT communication. IRT communication is mandatory for telegram 5 or 105.

Telegram 3

PZD01	PZD02	PZD03	PZD04	PZD05	PZD06	PZD07	PZD08	PZD09
STW1	NSOLL_B		STW2	G1_STW	---			
ZSW1	NIST_B		ZSW2	G1_ZSW	G1_XIST1		G1_XIST2	

Telegram 3 transfers the control words 1 and 2 (STW1, STW2), the status words 1 and 2 (ZSW1, ZSW2), the speed setpoint and actual value (NSOLL_B, NIST_B), control word and status word of encoder 1 (G1_STW, G1_ZSW), and the actual position value 1 and 2 of encoder 1 (G1_XIST1, G1_XIST2).

Telegram 5

PZD01	PZD02	PZD03	PZD04	PZD05	PZD06	PZD07	PZD08	PZD09
STW1	NSOLL_B		STW2	G1_STW	XERR		KPC	
ZSW1	NIST_B		ZSW2	G1_ZSW	G1_XIST1		G1_XIST2	

In addition to the values of telegram 3, telegram 5 transfers the values for position deviation (XERR) and gain factor for the position controller (KPC).

Telegram 102

PZD01	PZD02	PZD03	PZD04	PZD05	PZD06	PZD07	PZD08	PZD09	PZD10
STW1	NSOLL_B		STW2	MOM RED	G1_ STW	---			
ZSW1	NIST_B		ZSW2	MELDW	G1_ ZSW	G1_XIST1		G1_XIST2	

In addition to the values of telegram 3, telegram 102 transfers the value for the torque reduction (MOMRED) and the alarm word (MELDW).

Telegram 105

PZD01	PZD02	PZD03	PZD04	PZD05	PZD06	PZD07	PZD08	PZD09	PZD10
STW1	NSOLL_B		STW2	MOM RED	G1_ STW	XERR		KPC	
ZSW1	NIST_B		ZSW2	MELDW	G1_ ZSW	z.B.: G1_XIST1		z.B.: G1_XIST2	

In addition to the values of telegram 3, telegram 105 transfers the value for the torque reduction (MOMRED), the alarm word (MELDW), the values for the position deviation (XERR) and the gain factor for the position controller (KPC).

A.1.2 Supplementary telegrams

In addition to the main telegram, you can configure one or two supplementary telegrams. The supported supplementary telegrams are listed below.

Telegrams 700 und 701 transfer information about the Safety Integrated Functions. The data transfer is not safety relevant (single channel). For safety-relevant data transfer, use the PROFIsafe telegrams listed in the next section.

Using telegram 750, you can implement an electronic weight compensation for a vertical axis.

Telegram 750 can be transferred in addition to telegram 700 or telegram 701. The sequence can be set in HW Config.

Telegram 700

PZD01	PZD02	PZD03

S_ZSW1B	S_V_LIMIT_B	

Using the Safety Info Channel (SIC), telegram 700 transfers the safety status word 1B (S_ZSW1B) and the value for the limitation of the setpoint velocity (S_V_LIMIT_B).

Telegram 701

PZD01	PZD02	PZD03	PZD04	PZD05
S_STW1B	S_STW3B	---		
S_ZSW1B	S_ZSW2B	S_V_LIMIT_B	S_ZSW3B	

In addition to telegram 700, telegram 701 transfers the following data:

- Via the Safety Control Channel (SCC) the safety control word 1B (S_STW1B) and the safety control word 3B (S_STW3B).
- Via the Safety Info Channel (SIC) the safety status word 2B (S_ZSW2B) and the safety status word 3B (S_ZSW3B).

Telegram 750

PZD01	PZD02	PZD03
M_ADD	M_LIMIT_POS	M_LIMIT_NEG
M_ACT	---	

Telegram 750 is a supplementary telegram for the torque control with the following data:

- The controller sends the additional torque (M_ADD) and the positive and negative torque limit (M_LIMIT_POS, M_LIMIT_NEG) to the converter.
- The converter sends the current torque (M_ACT) to the control.

A.1.3 PROFIsafe Telegrams

The converter supports the PROFIsafe telegrams 30 and 901. One of these telegrams is required to control the Safety Integrated functions via PROFIsafe.

You only require telegram 901 if you use the SS2E or SLS function via PROFIsafe.

Telegram 30

PZD01
S_STW1
S_ZSW1

Telegram 30 transfers Safety control word 1 (S_STW1) and safety status word 1 (S_ZSW1).

Telegram 901

PZD01	PZD02	PZD03	PZD04	PZD05
S_STW2	S_SLS_LIM_A	---		
S_ZSW2	S_SLS_LIM_A_ACT	S_CYC_COUNT	S_XIST16	

In addition to Safety control word 2 (S_STW2) as well as Safety status word 2 (S_ZSW2), telegram 901 transfers the variable SLS limit (S_SLS_LIM_A), the active SLS value of level 1 (S_SLS_LIM_A_ACT), a counter value (S_CYC_COUNT), and the safe position value in 16-bit format (S_XIST16).

A.1.4 Bit assignments of the process data

Note

Representation of the sending direction Controller -> Converter and Converter -> Controller

The left column always shows the process data that is sent from the controller to the converter (control words and setpoints).

The process data that is sent from the converter to the controller is displayed in the right column (status words and actual values).

A.1.4.1 Control word 1 and status word 1

Control word 1 (STW1)

Bit	Meaning
00	ON / OFF1
01	OFF2
02	OFF3
03	Enable operation
04	Reserved
05	Reserved
06	Enable speed setpoint
07	Acknowledge fault
08	Reserved
09	Reserved
10	Master control by PLC
11	Reserved
12	Open holding brake
13	Reserved
14	Torque / speed control
15	Reserved

Status word 1 (ZSW1)

Bit	Meaning
00	Ready for switching on
01	Ready for operation
02	Operation enabled
03	Fault active
04	No coast down active
05	No quick stop active
06	Switching-on inhibited active
07	Alarm active
08	Controller release
09	Control requested
10	Comparison value reached/exceeded
11	Alarm class bit 0
12	Alarm class bit 1
13	Reserved
14	Closed-loop torque control active
15	Reserved

A.1.4.2 Control word 2 and status word 2

Control word 2 (STW2)

Bit	Meaning
00	Reserved
01	Reserved
02	Reserved
03	Reserved
04	Reserved
05	Reserved
06	Integrator lock speed controller
07	Parking axis selection
08	Travel to fixed stop
09	Reserved
10	Reserved
11	Reserved
12	Controller sign-of-life bit 0
13	Controller sign-of-life bit 1
14	Controller sign-of-life bit 2
15	Controller sign-of-life bit 3

Status word 2 (ZSW2)

Bit	Meaning
00	Reserved
01	Reserved
02	Reserved
03	Reserved
04	Reserved
05	Open holding brake
06	Integrator lock speed controller
07	Parking axis active
08	Travel to fixed stop
09	Reserved
10	Reserved
11	Reserved
12	Device sign-of-life bit 0
13	Device sign-of-life bit 1
14	Device sign-of-life bit 2
15	Device sign-of-life bit 3

A.1.4.3 Encoder-1 control word and encoder-1 status word

Encoder 1 control word (G1_STW)

Bit	Meaning
00	Request function 1
01	Request function 2
02	Request function 3
03	Request function 4
04	Request command bit 0
05	Request command bit 1
06	Request command bit 2
07	Mode
08	Reserved
09	Reserved
10	Reserved
11	Reserved
12	Reserved
13	Request absolute value cyclically
14	Request parking encoder
15	Acknowledge encoder fault

Encoder 1 status word (G1_ZSW)

Bit	Meaning
00	Function 1 active
01	Function 2 active
02	Function 3 active
03	Function 4 active
04	Value 1
05	Value 2
06	Value 3
07	Value 4
08	Measuring input 1 deflected
09	Measuring input 2 deflected
10	Reserved
11	Acknowledge encoder fault active
12	Reserved
13	Cyclic absolute value
14	Parking encoder active
15	Encoder fault

A.1.4.4 Safety control word 1 and safety status word 1

Safety control word 1 (S_STW1)

Bit	Meaning
00	Deselect STO
01	Deselect SS1
02	Deselect SS2
03	Deselect SOS
04	Deselect SLS
05	Reserved
06	Reserved
07	Safe acknowledgment
08	Deselect SLA
09	Select SLS bit 0
10	Select SLS bit 1
11	Reserved
12	Deselect SDI positive
13	Deselect SDI negative
14	Reserved
15	Reserved
16	Reserved

Safety status word 1 (S_ZSW1)

Bit	Meaning
00	STO active
01	SS1 active
02	SS2 active
03	SOS active
04	SLS active
05	Reserved
06	Reserved
07	Internal event
08	SLA active
09	SLS limit bit 0 active
10	SLS limit bit 1 active
11	SOS selected
12	SDI positive active
13	SDI negative active
14	Reserved
15	SSM (speed, lower limit value)
16	Reserved

A.1.4.5 Safety control word 2 and safety status word 2

Safety control word 2 (S_STW2)

Bit	Meaning
00	Deselect STO
01	Deselect SS1
02	Deselect SS2
03	Deselect SOS
04	Deselect SLS
05	Reserved
06	Reserved
07	Safe acknowledgment
08	Deselect SLA
09	Select SLS bit 0
10	Select SLS bit 1
11	Reserved
12	Deselect SDI positive
13	Deselect SDI negative
14	Reserved
15	Reserved
16	Reserved
17	Reserved
18	Reserved
19	Reserved
20	Reserved
21	Reserved
22	Reserved
23	Reserved
24	Reserved
25	Reserved
26	Reserved
27	Reserved
28	Deselect SS2E
29	Reserved
30	Reserved
31	Reserved

Safety status word 2 (S_ZSW2)

Bit	Meaning
00	STO active
01	SS1 active
02	SS2 active
03	SOS active
04	SLS active
05	Reserved
06	Reserved
07	Internal event
08	SLA active
09	SLS limit bit 0 active
10	SLS limit bit 1 active
11	Reserved
12	SDI positive active
13	SDI negative active
14	Reserved
15	SSM (speed, lower limit value)
16	Reserved
17	Reserved
18	Reserved
19	Reserved
20	Reserved
21	Reserved
22	Reserved
23	Reserved
24	Reserved
25	Reserved
26	Reserved
27	Reserved
28	SS2E active
29	SOS selected
30	Reserved
31	Reserved

A.1.4.6 Safety control word 1B and safety status word 1B

Safety control word 1B (S_STW1B)

Bit	Meaning
00	Reserved
01	Reserved
02	Reserved
03	Reserved
04	Reserved
05	Reserved
06	Reserved
07	Reserved
08	Extended Functions, test stop
09	Reserved
10	Reserved
11	Reserved
12	Reserved
13	Reserved
14	Reserved
15	Reserved

Safety status word 1B (S_ZSW1B)

Bit	Meaning
00	STO active
01	SS1 active
02	SS1 active
03	SS1 active
04	SS1 active
05	SS1 active
06	SS1 active
07	Internal event
08	SLA active
09	SLS Limit Bit 0 active
10	SLS Limit Bit 1 active
11	Reserved
12	SDI positive selected
13	SDI negative selected
14	Reserved
15	Safety alarm valid

A.1.4.7 Safety status word 2B

Safety status word 2B (S_ZSW2B)

Bit	Meaning
00	Reserved
01	Reserved
02	Reserved
03	Reserved
04	Reserved
05	Reserved
06	Reserved
07	Reserved
08	SDI positive
09	SDI negative
10	Reserved
11	Reserved
12	Test stop active
13	Test stop required
14	Reserved
15	Reserved

A.1.4.8 Safety control word 3B and safety status word 3B

Safety control word 3B (S_STW3B)

Bit	Meaning
00	Brake test selection
01	Brake test start
02	Brake selection
03	Select direction of rotation
04	Select test sequence
05	Status of external brake
06	Reserved
07	Reserved
08	Reserved
09	Reserved
10	Reserved
11	Reserved
12	Reserved
13	Reserved
14	Reserved
15	Reserved

Safety status word 3B (S_ZSW3B)

Bit	Meaning
00	Brake test
01	Setpoint specification
02	Brake active
03	Brake test active
04	Brake test result
05	Brake test completed
06	Request external brake
07	Sign load
08	Reserved
09	Reserved
10	Reserved
11	SS2E
12	Reserved
13	Reserved
14	Acceptance test SLEP selected
15	Acceptance test mode selected

A.1.4.9 Message word

Message word (MELDW)

Bit	Meaning
00	Reserved
01	Torque utilization < threshold 2
02	$ n_actual < \text{speed threshold 3}$
03	$ n_actual \leq \text{speed threshold 2}$
04	Reserved
05	Reserved
06	No warning motor overtemperature
07	No warning converter overtemperature
08	n-target/actual deviation within tolerance
09	Reserved
10	Reserved
11	Servo enable
12	Drives ready
13	Pulses enabled
14	Reserved
15	Reserved

A.2 What is the difference between the Emergency Off and Emergency Stop functions?

A.2 What is the difference between the Emergency Off and Emergency Stop functions?

"Emergency Off" and "Emergency Stop" are commands that minimize different risks in the machine or plant.

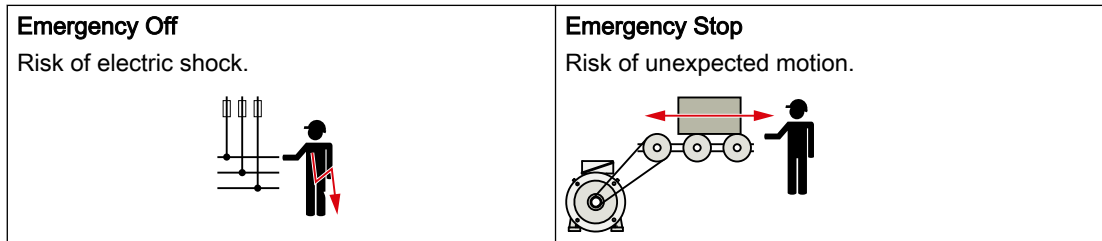
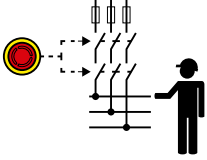
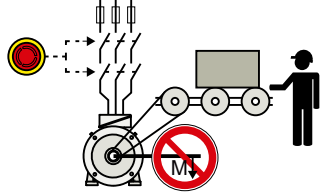
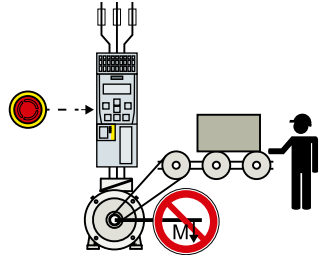

Table A-1 Measures and solutions

Command	Emergency Off	Emergency Stop
Measure to minimize risk	Safe switch off Switching off the electric power supply for the installation, either completely or partially.	Safely stop and safely prevent restarting Stopping or preventing the dangerous movement
Classic solution	Switch off the power supply. 	Switch off the drive power supply. 
Solution with the STO safety function integrated in the drive	STO is not suitable for safely switching off a voltage.	Select STO.  It is permissible that you switch off the converter power supply as well. However, switching off the voltage is not required as a risk-reduction measure.

A.3 Directives and standards

A.3.1 Directives, standards and certificates for the converter

Directives and standards that are complied with

The converters comply with the following directives and standards:



European Low-Voltage Directive

The converter fulfills the requirements stipulated in the Low-Voltage Directive 2014/35/EU, if they are covered by the field of application of this directive.

European Machinery Directive

The converter fulfills the requirements stipulated in the Machinery Directive 2006/42/EU, if they are covered by the field of application of this directive.

However, the use of the converter in a typical machine application has been fully assessed for compliance with the main regulations in this directive concerning health and safety.

European EMC Directive

The compliance of the converter with the regulations of the Directive 2014/30/EU has been verified through full compliance with the IEC/EN 61800-3.

Safety Integrated

The converters comply with the requirements relating to functional safety/safety of machinery.

RoHS

The converters comply with directive 2011/65/EU regarding limiting the use of certain hazardous substances.



Underwriters Laboratories (North American market)

Converters provided with one of the test symbols displayed on the left fulfill the requirements stipulated for the North American market as a component of drive applications, and are appropriately listed. (UL File Number: E355661)



Eurasian conformity

The converter complies with the requirements of the Russia/Belarus/Kazakhstan customs union (EAC).



Australia and New Zealand (RCM formerly C-Tick)

The converters showing the test symbols fulfill the EMC requirements for Australia and New Zealand.



EMC requirements for South Korea

Converters with the KC marking on the rating plate satisfy the EMC requirements for South Korea.

At the present time, converters with 1 AC line connection satisfy the requirements.

It is scheduled that converters with 3 AC line connection will satisfy this requirement in the third quarter of 2019.

Certificates for download



- EC declaration of conformity: (<https://support.industry.siemens.com/cs/de/de/view/60438382>)
- Certificates for the relevant directives, prototype test certificates, manufacturers declarations and test certificates for functions relating to functional safety ("Safety Integrated"): (<https://support.industry.siemens.com/cs/ww/en/ps/13229/cert>)
- Certificates of products that were certified by UL: (<http://database.ul.com/cgi-bin/XYV/template/LISEXT/1FRAME/index.html>)

Standards that are not relevant



China Compulsory Certification

The converter does not fall in the area of validity of the China Compulsory Certification (CCC).

A.3.2 Directives, standards and certificates for the motor

Standards that are complied with

The motors of the type series SIMOTICS S, SIMOTICS M, SIMOTICS L, SIMOTICS T, SIMOTICS A, called "SIMOTICS motor series" below, fulfill the requirements of the following directives and standards:

- EN 60034-1 - Rotating electrical machines – Dimensioning and operating behavior
- EN 60204-1 - Safety of machinery – Electrical equipment of machines; general requirements

Where applicable, the SIMOTICS motor series are in conformance with the following parts of EN 60034:

Feature	Standard
Degree of protection	EN 60034-5
Cooling ¹⁾	EN 60034-6
Type of construction	EN 60034-7
Connection designations	EN 60034-8
Noise levels ¹⁾	EN 60034-9

Feature	Standard
Temperature monitoring	EN 60034-11
Vibration severity grades ¹⁾	EN 60034-14

¹⁾ Standard component, e.g. cannot be applied to built-in motors

Relevant directives

The following directives are relevant for SIMOTICS motors.

European Low-Voltage Directive

SIMOTICS motors comply with the Low-Voltage Directive 2014/35/EU.



European Machinery Directive

SIMOTICS motors do not fall within the scope covered by the Machinery Directive.

However, the use of the products in a typical machine application has been fully assessed for compliance with the main regulations in this directive concerning health and safety.

European EMC Directive

SIMOTICS motors do not fall within the scope covered by the EMC Directive. The products are not considered as devices in the sense of the directive. Installed and operated with a converter, the motor - together with the Power Drive System - must comply with the requirements laid down in the applicable EMC Directive.

European RoHS Directive

The SIMOTICS motor series complies with the Directive 2011/65/EU regarding limiting the use of certain hazardous substances.

European Directive on Waste Electrical and Electronic Equipment (WEEE)

The SIMOTICS motor series complies with the 2012/19/EU directive on taking back and recycling waste electrical and electronic equipment.

Eurasian conformity

SIMOTICS motors comply with the requirements of the Russia/Belarus/Kazakhstan (EAC) customs union.



China Compulsory Certification

SIMOTICS motors do not fall within the scope covered by the China Compulsory Certification (CCC).



CCC negative certification:

CCC product certification (<https://support.industry.siemens.com/cs/products?search=CCC&ntp=Certificate&mfn=ps&o=DefaultRankingDesc&pnid=13347&lc>)

Underwriters Laboratories

SIMOTICS motors are generally in compliance with UL and cUL as components of motor applications, and are appropriately listed.



Specifically developed motors and functions are the exceptions in this case. Here, it is important that you carefully observe the contents of the quotation and that there is a cUL mark on the rating plate!

Quality systems

Siemens AG employs a quality management system that meets the requirements of ISO 9001 and ISO 14001.

Certificates for SIMOTICS motors can be downloaded from the Internet at the following link:

Certificates for SIMOTICS motors (<https://support.industry.siemens.com/cs/ww/de/ps/13347/cert>)

A.4 Certifications

The safety functions of the SINAMICS S drive system meet the following requirements:

- Category 3 to DIN EN ISO 13849-1
- Performance level (PL) d according to DIN EN ISO 13849-1
- Safety integrity level 2 (SIL 2) according to IEC 61508 and EN 61800-5-2

In addition, most of the safety functions of the SINAMICS S have been certified by independent institutes. A list of currently certified components is available on request from your local Siemens office.

A.5 Certificates for the secure data transfer

Overview

The "Transport Layer Security" (TLS) protocol enables encrypted data transfer between a client and the SINAMICS drive. HTTPS access of the browser to the drive is based on the "Transport Layer Security" protocol. This section informs you which steps you need to follow to enable encrypted data transfer between a browser (client) and the SINAMICS (server).

You will find information on the configuration of your IP connection in Section:

 "Configuring the IP connection (Page 243)" .

Protecting the HTTPS access

The encrypted variant of the communication between the browser and the Web server using HTTPS requires the creation and installation of certificates.

Basically, there are three ways of creating a server certificate:

- Using the standard configuration
- Use self-created certificates (by means of certificate software, such as OpenSSL)
- Use a server certificate from a certificate authority

Delivery state

A private key is generated as a file on the device as default configuration when you first use HTTPS so that you can access the drive via HTTPS in the SINAMICS delivery state. During an HTTPS access using this key, a warning is issued in the browser that the certificate is unknown.

Duration of validity

The certificates are valid up to 2030.

After expiration of the validity period, install new valid certificates on all the relevant drives.

A.5.1 Certificate standard configuration

Note

Security

The use of a default configuration described in the following is not the most secure way of transferring data using the HTTPS protocol to your drive with the Web server.

For this reason, it should only be used in secure networks (e.g. your PROFINET below a PLC) or for direct point-to-point connections on the Service interface X127.

Using the certificate default configuration

Procedure

1. First open an HTTPS Web server connection to your drive in the browser.
2. The firmware then creates a new server certificate and a private server key from the root certificate and the private key, if they are not already available. This certificate is individualized for the IP address of the interface used for the communication.
3. Following this, a warning is issued on the standard browser that the certificate is unknown.
4. Import the server certificate into your standard browser or deactivate the security warnings for the SINAMICS Websites.

The exact procedure for the import can be found in the online help of the used browser.

Deactivating warnings in the most important browsers

You can deactivate warnings in the most important browser as follows:

Opera

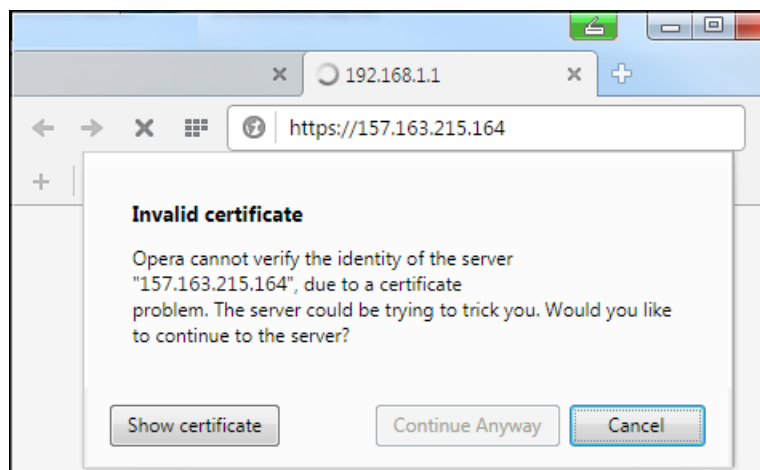

Figure A-1 Opera1

Click "Still continue" in order to be able to communicate via a secure HTTPS connection.

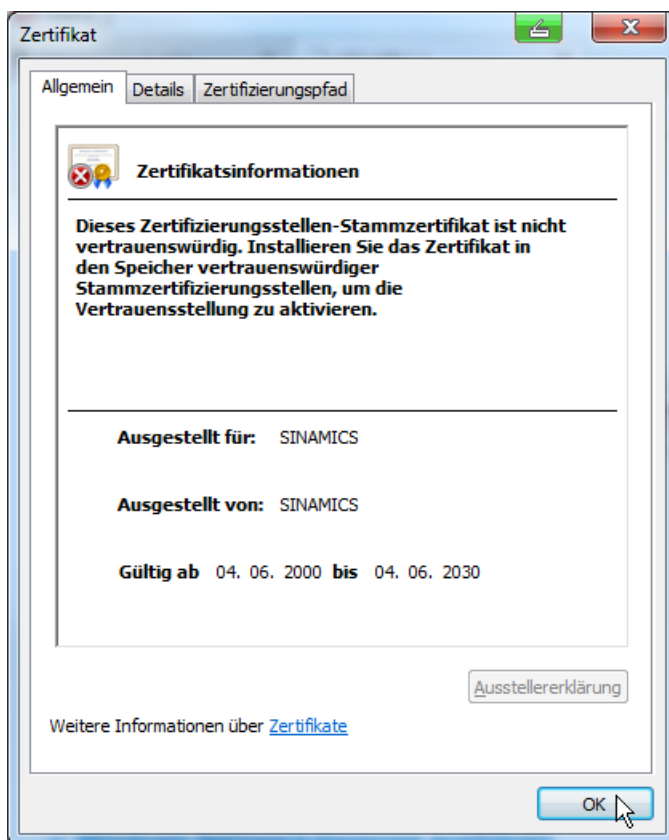

Figure A-2 Opera2

Mozilla Firefox

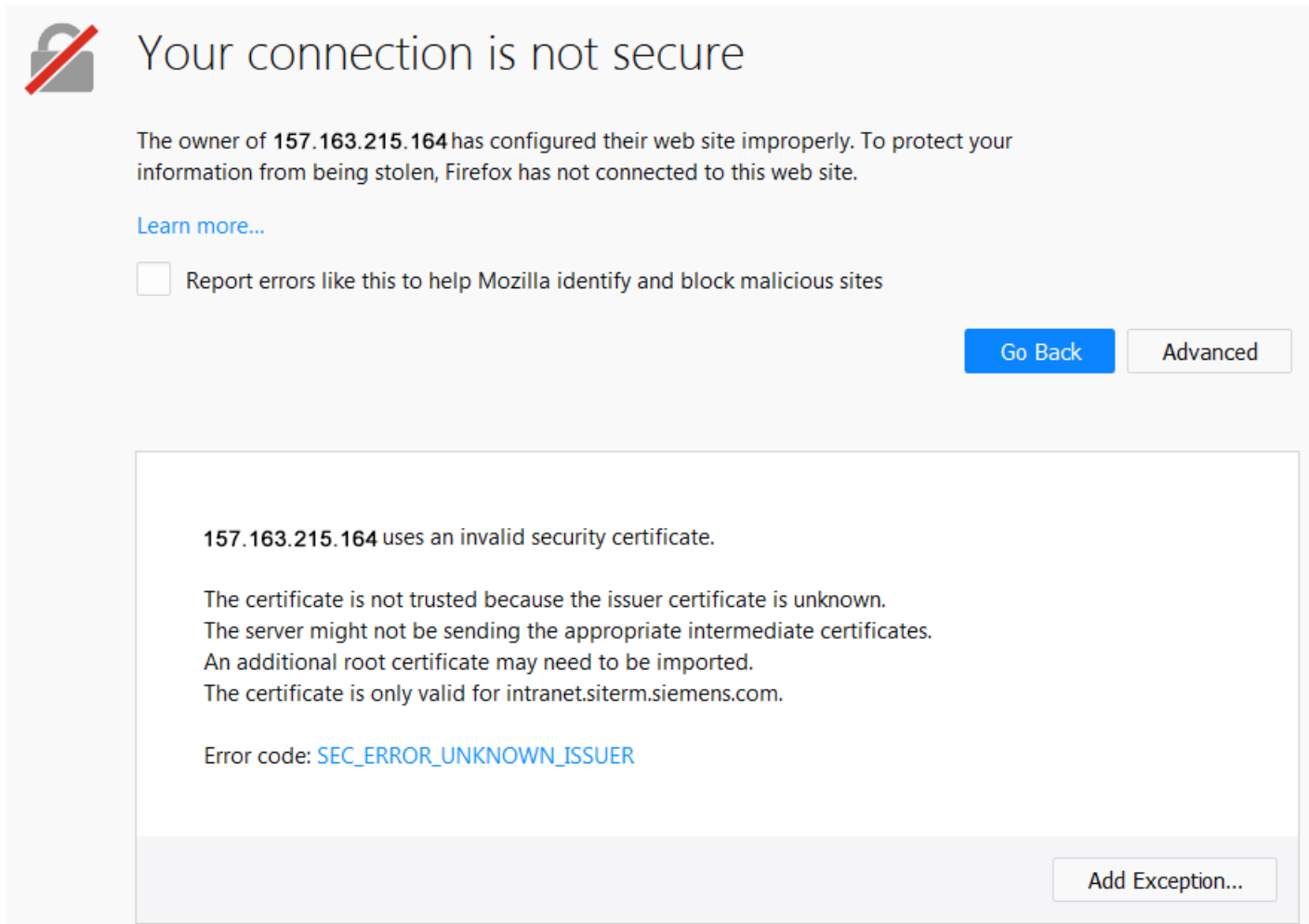

Figure A-3 Mozilla

1. Click "Extended".
The information for the security certificate is displayed.
2. Click "Add exception" in order to be able to communicate via a secure HTTPS connection.

Microsoft Internet Explorer 11

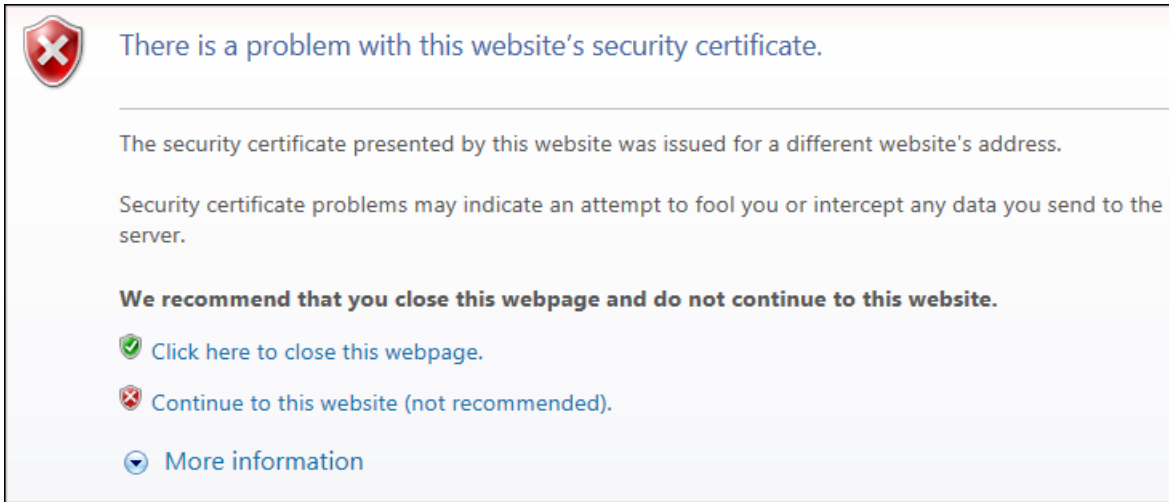

Figure A-4 Internet Explorer 11

Click "Continue to this website" in order to be able to communicate via a secure HTTPS connection.

Google Chrome

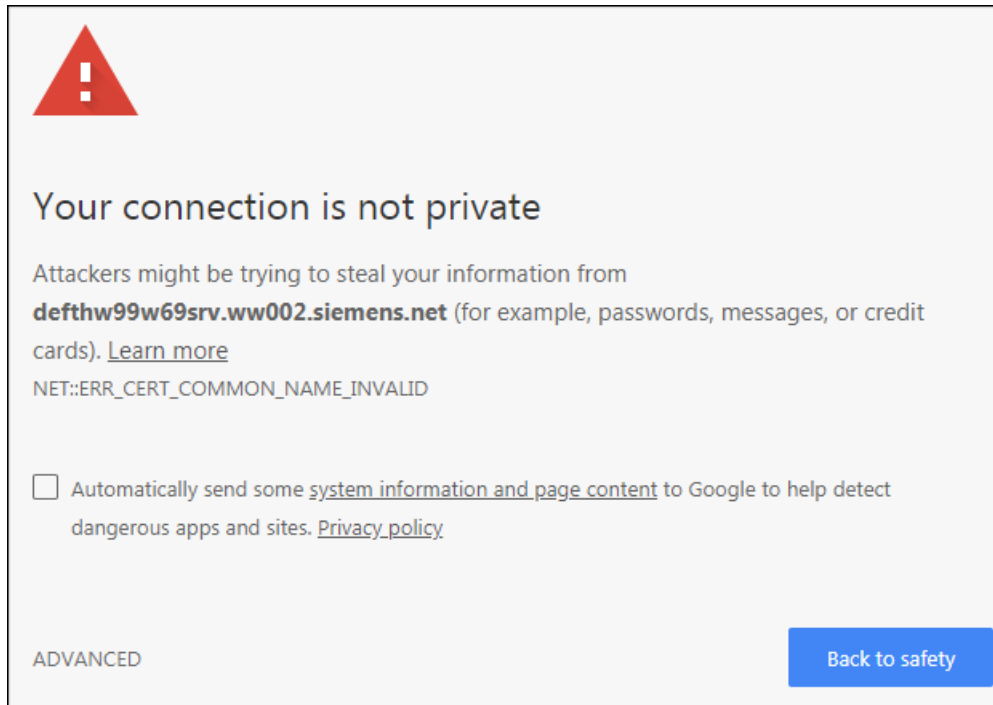

Figure A-5 Google 1

1. Click "EXTENDED".
The information for the security certificate is displayed.
2. Click "Continue to <IP address>" in order to be able to communicate via a secure HTTPS connection.

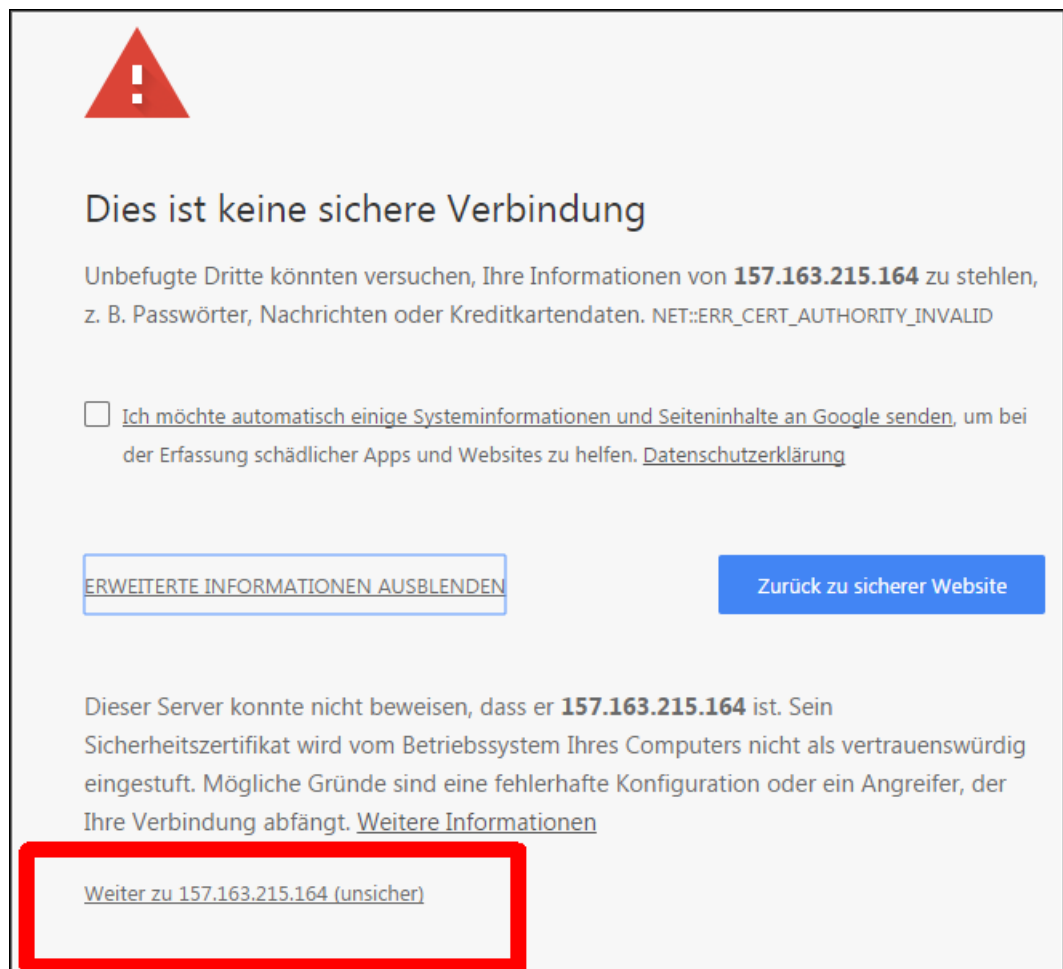

Figure A-6 Google 2

A.5.2 Your own certificates

You can either generate your own certificates for the secured data connection or purchase them from a certification authority (CA). In these cases, a server certificate and a private server key are supplied.

- Server certificate: <IP addr>.TLS.crt Example: 192.168.2.90.TLS.crt
- Private server key: <IP addr>.TLS.key Example: 192.168.2.90.TLS.key

Certification authorities, from which you can purchase a certificate can be found on the Internet; the same is true for software so that you can generate a certificate yourself, e.g. OpenSSL.

Using your own certificate

Requirements

You have a suitable SD card for your converter.

You have a server certificate and a private server key.

Procedure

1. Copy the server certificate and the private server key into the following directory on the SD card of your converter:
OEM\SINAMICS\WEB\WEBCONF\CERT
2. Rename the files to SINAMICS.key und SINAMICS.crt.
3. Create a backup copy of both files.
4. Import the certificate (*.crt) in the browser of your commissioning device so that it can communicate with the browser.
Refer to the instructions (help) of your browser for the importing procedure.
5. Insert the memory card into your converter and switch on the converter.
6. Open an HTTPS Web server connection to your drive in the browser (<https://169.254.11.22/>).

The connection is established once the certificate has been imported.



If the certificate was not imported, the message indicating that the signed CA is unknown is displayed when you open the browser.

A.6 List of abbreviations

Note

The following list of abbreviations includes the abbreviations and meanings as used for the SINAMICS.

Abbreviation	Derivation of abbreviation	Meaning
A...	Alarm	Alarm
AC	Alternating Current	Alternating current
C...	-	Safety message
CoL	Certificate of License	Certificate of License
COM	Communication LED	Status display of the communication
COMM	Commissioning	Commissioning
CU	Control Unit	Control Unit
DC	Direct Current	Direct current
DI	Digital Input	Digital input
DO	Drive Object	Drive object
DP	Decentralized Peripherals	Distributed I/O
DSC	Dynamic Servo Control	Dynamic servo control
EEPROM	Electrically Erasable Programmable Read-Only Memory	Electrically Erasable Programmable Read-Only Memory
EMV	Elektromagnetische Verträglichkeit	Electromagnetic compatibility
EN	Europäische Norm	European standard
F...	Fault	Fault
F-DI	Failsafe Digital Input	Failsafe digital input
FAQ	Frequently Asked Questions	Frequently asked questions
GB	Gigabyte	Gigabyte
GSD	Gerätstammdatei	Generic station description file: Describes the features of a PROFIBUS slave
HW	Hardware	Hardware
IBN	Inbetriebnahme	Commissioning
ID	Identifier	Identification
IEC	International Electrotechnical Commission	International Electrotechnical Commission
IP	Internet Protocol	Internet protocol
Kp	-	Proportional gain
LED	Light Emitting Diode	Light emitting diode
M	Masse	Reference potential for all signal and operating voltages, usually defined as 0 V (also referred to as GND)
MB	Megabyte	Megabyte
MT	Messtaster	Measuring input

Abbreviation	Derivation of abbreviation	Meaning
N...	No Report	No message or internal message (only as part of the alarm list)
NTP	Network Time Protocol	Synchronizes the clocks in computer systems and networks
NVRAM	Non-Volatile Random Access Memory	Non-volatile read/write memory
OCC	One Cable Connection	One cable technology
OEM	Original Equipment Manufacturer	Original Equipment Manufacturer
p...	-	Adjustable parameters
PDS	Power Drive System	Drive system
PE	Protective Earth	Protective ground
PELV	Protective Extra Low Voltage	Safety extra-low voltage
PFH	Probability of dangerous failure per hour	Probability of dangerous failure per hour
PLC	Programmable Logical Controller	Programmable logic controller
PN	PROFINET	PROFINET
PZD	Prozessdaten	Process data
r...	-	Display parameters (read-only)
RAM	Random Access Memory	Memory for reading and writing
RJ45	Registered Jack 45	Term for an 8-pin socket system for data transmission with shielded or non-shielded multi-wire copper cables
ROM	Read-Only Memory	Read-only memory
S1	-	Continuous operation
SAM	Safe Acceleration Monitor	Safe acceleration monitoring
SBC	Safe Brake Control	Safe brake control
SBR	Safe Brake Ramp	Safe brake ramp monitoring
SBT	Safe Brake Test	Safe brake test
SD-Card	SecureDigital Card	Secure digital memory card
SCC	Safety Control Channel	Safety Control Channel
SDI	Safe Direction	Safe motion direction
SI	Safety Integrated	Safety Integrated
SIC	Safety Info Channel	Safety Info Channel
SIL	Safety Integrity Level	Safety integrity level
SLS	Safely-Limited Speed	Safely-limited speed
SOS	Safe Operating Stop	Safe operating stop
SP	Service Pack	Service pack
SPS	Speicherprogrammierbare Steuerung	Programmable logic controller
SS1	Safe Stop 1	Safe stop 1 (monitored for time and ramp)
SS1E	Safe Stop 1 External	Safe stop 1 with external stop
SS2	Safe Stop 2	Safe stop 2
SS2E	Safe Stop 2 External	Safe stop 2 with external stop
SSM	Safe Speed Monitor	Safe feedback from speed monitor

Abbreviation	Derivation of abbreviation	Meaning
STO	Safe Torque Off	Safe torque off
STW	Steuerwort	Control word
TIA	Totally Integrated Automation	Totally Integrated Automation
Tn	-	Integral time
UL	Underwriters Laboratories Inc.	Underwriters Laboratories Inc.
UTC	Universal Time Coordinated	Universal time coordinated
Vdc	-	DC-link voltage
VDE	Verband Deutscher Elektrotechniker	Association of German Electrical Engineers
ZSW	Zustandswort	Status word

Index

A

Acceptance test, 127

 Extended Functions, 132

 Report, 127

 SBC, 132

 SS1, 131

 STO, 129

Acceptance test mode, 224

Address

 License Manager in the Internet, 74

Alarm, 261

Alarm code, 261

Alarm time, 261

Alarm value, 261

Alert

 A01006, 423

 A01007, 424

 A01009, 424

 A01016, 425

 A01019, 426

 A01020, 426

 A01035, 427

 A01045, 432

 A01049, 432

 A01064, 432

 A01069, 433

 A01073, 433

 A01099, 435

 A01251, 436

 A01304, 436

 A01306, 436

 A01330, 436

 A01489, 437

 A01590, 437

 A01631, 443

 A01637, 443

 A01638, 443

 A01654, 447

 A01691, 457

 A01693, 458

 A01695, 458

 A01696, 458

 A01697, 459

 A01698, 459

 A01699, 459

 A01706, 460

 A01707, 461

A01709, 461

A01711, 462

A01714, 467

A01716, 468

A01730, 468

A01750, 468

A01751, 468

A01780, 469

A01781, 469

A01782, 469

A01783, 470

A01784, 470

A01785, 470

A01788, 471

A01796, 471

A01798, 471

A01799, 472

A01839, 472

A01900, 473

A01902, 474

A01932, 475

A01940, 475

A01941, 476

A01943, 476

A01944, 476

A01980, 477

A01981, 477

A01989, 477

A02007, 477

A05000, 478

A05001, 478

A05003, 478

A05006, 478

A07012, 479

A07091, 480

A07092, 480

A07094, 481

A07095, 481

A07200, 482

A07565, 485

A07805, 485

A08511, 488

A08800, 489

A09000, 489

A13001, 490

A13021, 491

A13030, 491

A13031, 491

A13032, 491

A13033, 491	F01357, 437
A30016, 495	F01600, 438
A30031, 500	F01611, 438
A30034, 500	F01625, 442
A30041, 501	F01630, 442
A30042, 502	F01640, 443
A30044, 502	F01641, 444
A30054, 503	F01649, 444
A30076, 504	F01650, 445
A30077, 504	F01651, 446
A30502, 505	F01653, 446
A30693, 514	F01655, 447
A30706, 515	F01656, 448
A30707, 515	F01657, 448
A30709, 516	F01658, 449
A30711, 516	F01659, 449
A30714, 518	F01663, 450
A30716, 519	F01670, 450
A30730, 519	F01671, 451
A30788, 519	F01672, 451
A30798, 519	F01673, 452
A30799, 520	F01674, 452
A30999, 521	F01675, 452
A31700, 528	F01679, 453
A40100, 537	F01680, 453
F01000, 421	F01681, 453
F01001, 421	F01682, 455
F01002, 421	F01683, 456
F01003, 422	F01685, 456
F01005, 422	F01689, 457
F01011, 424	F01690, 457
F01012, 424	F01694, 458
F01015, 425	F01700, 460
F01018, 425	F01701, 460
F01023, 426	F01708, 461
F01030, 426	F01800, 472
F01031, 426	F01910, 474
F01033, 427	F01911, 475
F01034, 427	F01912, 475
F01036, 427	F01950, 476
F01039, 428	F03001, 477
F01040, 428	F06310, 478
F01041, 429	F07011, 479
F01042, 429	F07085, 479
F01043, 431	F07093, 480
F01044, 432	F07097, 482
F01050, 432	F07220, 482
F01072, 433	F07410, 482
F01082, 433	F07412, 483
F01120, 435	F07414, 483
F01122, 435	F07433, 484
F01250, 435	F07434, 484

F07575, 485
 F07801, 485
 F07802, 485
 F07860, 486
 F07900, 486
 F07901, 486
 F07930, 486
 F07935, 487
 F07955, 488
 F08501, 488
 F13000, 489
 F13009, 490
 F13010, 490
 F13100, 492
 F13101, 492
 F13102, 492
 F30001, 493
 F30002, 493
 F30003, 494
 F30004, 494
 F30005, 494
 F30011, 495
 F30015, 495
 F30017, 496
 F30021, 496
 F30024, 497
 F30025, 497
 F30027, 498
 F30036, 501
 F30040, 501
 F30043, 502
 F30050, 503
 F30051, 503
 F30052, 503
 F30055, 503
 F30068, 504
 F30075, 504
 F30078, 505
 F30600, 505
 F30611, 506
 F30625, 508
 F30630, 508
 F30649, 509
 F30650, 509
 F30651, 510
 F30655, 510
 F30656, 511
 F30657, 511
 F30659, 512
 F30674, 512
 F30680, 512
 F30681, 512
 F30682, 513
 F30683, 514
 F30685, 514
 F30700, 514
 F30701, 515
 F30708, 516
 F30805, 520
 F30895, 520
 F30899, 520
 F30950, 521
 F31120, 521
 F31135, 522
 F31136, 523
 F31137, 524
 F31138, 526
 F31405, 528
 F31801, 528
 F31802, 528
 F31804, 529
 F31805, 529
 F31806, 529
 F31813, 530
 F31820, 530
 F31835, 531
 F31836, 531
 F31837, 532
 F31845, 532
 F31850, 532
 F31851, 533
 F31860, 533
 F31875, 534
 F31885, 535
 F31886, 535
 F31887, 535
 F31895, 536
 F31896, 536
 F31950, 536
 F40000, 537
 N01004, 422
 N01620, 441
 N01621, 441
 N30620, 507
 N30621, 507
 N30800, 520
 Axial eccentricity, 287

C

Cable lengths, motor, 148
 Certificate of License, 74
 Certificates
 EAC, 551

- EC Declaration of Conformity, 552
 - UL and cUL, 551
- COM (PROFINET link), 257
- Commissioning
 - Assigning drive names in the web server, 196
 - Basic commissioning, 198
 - Checking Safety Integrated settings, 227
 - Configuring administrator access, 183
 - Configuring brake control, 202
 - Configuring digital inputs, 204
 - Perform One Button Tuning, 198
 - Preparing the hardware, 179
 - Safety Integrated, 213
 - Setting limits, 201
- Concentricity, 287
- Configure IP connection, 243
- Connection type, 179
- Control panel
 - Control mode, 191
 - Monitoring mode, 191

D

- Data backup
 - Backing up parameters externally, 238
 - Restoring factory settings, 239, 270, 271
 - Restoring the parameter data, 239
- DE: Drive End (end with the motor shaft), 286
- Degree of protection, 283
- Diagnostics
 - Displaying communication settings, 235
 - Displaying message details, 232
 - Filtering messages, 233
 - Safety Integrated, 230
- DIN EN 61508, 75
- DIN EN 61800-5-2, 75
- DIN EN ISO 13849-1, 75
- Direction of motor rotation, 197

E

- Electrical installation, 155
- Electronic weight compensation for a vertical axis, 541
- EMC, 47

F

- Fault, 262
 - Acknowledging, 262

- Faults and alarms
 - Overview, 419
- F-DI
 - Discrepancy, 121
- Forced checking procedure, 223
- Function selection
 - Safety Integrated, 216

H

- Hotline, 4
- HTTP, 179
- HTTPS, 179
 - Security certificate, 555
 - With security certificate, 554

I

- Interfaces, 179
- IP21 degree of protection, 144
- IT system, 51

L

- LED
 - COM, 246, 257, 269
 - RDY, 246, 256, 257, 269
- License, 74
 - Missing, 248
 - Not satisfactory, 248
- License key, 74
 - Display, 251
 - Enter, 251
- Line supply type, 51
- List of faults and alarms, 419

M

- Memory card, 339
- Missing enables, 191
- Missing license, 248
- Motor direction of rotation, 197
- Motor replacement
 - Bearing damage, 265

N

- NDE: Non Drive End, 286
- Neutral conductor, 51

O

OCC, 194
 One Cable Connection, 194

P

Parameter list
 Filtering, 209
 Parameterization
 Basic Functions, 218
 Extended Functions, 219
 Parameterizing Basic Functions, 218
 Parameters
 Configuring the parameter list, 207
 Filtering the parameter list, 209
 Overview, 349
 Structure, 349
 Password
 Changing, 241
 Defining, 241
 Deleting, 242
 Safety Integrated, 226
 PFH value
 Safety Integrated, 75
 Power distribution systems, 51
 Probability of failure, 75
 Protective conductor, 51

R

Radial force loading, 289
 Rating plate, 37
 RDY (Ready), 256, 257
 Replacing the converter in a spare part scenario, 274
 Response times, 123
 Basic Functions via PROFIsafe, 125
 Basic Functions via terminals, 123
 Extended Functions, 126
 RoHS, 551

S

Safe Brake Test, 110
 Safely-Limited Acceleration, 108
 Safety Evaluation Tool, 75
 Safety Integrated
 Acknowledge fault, 122

 Checksums, 230
 Commissioning, 213
 Component replacement, 133
 Diagnostics, 230
 Function selection, 216
 Monitoring cycle, 123
 Overview, 75
 Password, 226
 PFH value, 75
 Read-only mode, 227
 Response times, 123
 Status, 230
 Switching the motor on again, 122
 Safety Integrated Basic Functions
 Configuring, 118
 SBC, 84
 SS1, 80
 SS1E-t, 82
 SS1-t, 80
 STO, 77
 Safety Integrated Extended Functions
 SAM, 113
 SBC, 88
 SBR, 115
 SBT, 110
 SDI, 106
 SLA, 108
 SLS, 99
 SOS, 97
 SS1, 88
 SS2-a, 94
 SS2-r, 96
 SSM, 105
 STO, 88
 Safety Integrated Functions
 Basic Functions, 76
 Extended Functions, 87
 Safety logbook, 231
 Safety monitoring cycle, 123
 Safety notes
 Electrical installation, 155
 SAM (Safe Acceleration Monitor), 113
 Saving
 Permanently (non-volatile), 193
 SBC (Safe Brake Control), 84, 88
 Acceptance test, 132
 SBR (Safe Brake Ramp), 115
 SBT (Safe Brake Test), 110
 SD card, (Article number)
 SDI (Safe Direction), 106
 Self-configuration, 194
 Series commissioning, 253

Service life of the fan, 273
Siemens Service Center, 4
Signal states, 256
SLA
 Safely-Limited Acceleration, 108
SLA (Safely-Limited Acceleration), 108
SLS
 Limit value via PROFIsafe, 103
SLS (Safely-Limited Speed), 99
Smooth running, 287
SOS (Safe Operating Stop), 97
Spare parts package, 343, 346
SS1 (Safe Stop 1), 88
 Acceptance test, 131
SS1E-t
 Flow diagram, 82
SS1-t
 Flow diagram, 81
SS2
 Safe Stop 2, 93
SSM (Safe Speed Monitor), 105
Standards
 EN 61800-3, 549
Status
 Safety functions, 230
Status display
 At the converter, 255
 Via LEDs, 255
STO (Safe Torque Off), 77, 88
 Acceptance test, 129
 Flow diagram, 78
Support information, 190

T

Technical features, 280
Technical Support, 4
Telegram
 102, 540
 105, 540
 3, 539
 30, 542
 5, 539
 700, 541
 701, 541
 750, 541
 901, 542
Test stop, 223
TLS, 554
TN system, 51
Transport Layer Security, 554
TT system, 51

V

Vibration response, 286

W

WEB License Manager, 74
Web server
 Access rights, 179
 Activating/deactivating time synchronization, 245
 Assigning a device name, 196
 Assuming control, 191, 198
 Automatic logout, 187
 Basic commissioning, 198
 Call the control panel, 191
 Changing the password, 241
 Configure IP connection, 243
 Configuring brake control, 202
 Configuring digital inputs, 204
 Configuring user accounts, 240
 Data backup, 238
 Defining a new password, 241
 Deleting the password, 242
 Diagnostics of the communication settings, 235
 Editing the parameter list, 207
 Filtering the parameter list, 209
 Login, 186
 Logout, 187
 Restoring factory settings, 239, 270
 Restoring the data backup, 239
 Returning control, 192, 198
 Safety Integrated, 216
 Saving data in a non-volatile fashion, 193
 Setting the converter system time, 245
 Setting the speed and torque limits, 201
 Supported browsers, 177
 User, 179

Additional information

Siemens:

www.siemens.com

Industry Online Support (service and support):

www.siemens.com/online-support

IndustryMall:

www.siemens.com/industrymall

Siemens AG
Digital Factory
Motion Control
P.O. Box 3180
D-91050 Erlangen
Germany

For additional
information on the
SINAMICS S210,
scan the QR code

