

SIEMENS

Ingenuity for life

Manual 07/2019

Function blocks to control the SINAMICS with SIMATIC S7 in TIA- Portal

SINAMICS S, G, V / communication / function block

<https://support.industry.siemens.com/cs/ww/en/view/109475044>

Siemens
Industry
Online
Support

Legal information

Use of application examples

Application examples illustrate the solution of automation tasks through an interaction of several components in the form of text, graphics and/or software modules. The application examples are a free service by Siemens AG and/or a subsidiary of Siemens AG ("Siemens"). They are non-binding and make no claim to completeness or functionality regarding configuration and equipment. The application examples merely offer help with typical tasks; they do not constitute customer-specific solutions. You yourself are responsible for the proper and safe operation of the products in accordance with applicable regulations and must also check the function of the respective application example and customize it for your system.

Siemens grants you the non-exclusive, non-sublicensable and non-transferable right to have the application examples used by technically trained personnel. Any change to the application examples is your responsibility. Sharing the application examples with third parties or copying the application examples or excerpts thereof is permitted only in combination with your own products. The application examples are not required to undergo the customary tests and quality inspections of a chargeable product; they may have functional and performance defects as well as errors. It is your responsibility to use them in such a manner that any malfunctions that may occur do not result in property damage or injury to persons.

Disclaimer of liability

Siemens shall not assume any liability, for any legal reason whatsoever, including, without limitation, liability for the usability, availability, completeness and freedom from defects of the application examples as well as for related information, configuration and performance data and any damage caused thereby. This shall not apply in cases of mandatory liability, for example under the German Product Liability Act, or in cases of intent, gross negligence, or culpable loss of life, bodily injury or damage to health, non-compliance with a guarantee, fraudulent non-disclosure of a defect, or culpable breach of material contractual obligations. Claims for damages arising from a breach of material contractual obligations shall however be limited to the foreseeable damage typical of the type of agreement, unless liability arises from intent or gross negligence or is based on loss of life, bodily injury or damage to health. The foregoing provisions do not imply any change in the burden of proof to your detriment. You shall indemnify Siemens against existing or future claims of third parties in this connection except where Siemens is mandatorily liable.

By using the application examples you acknowledge that Siemens cannot be held liable for any damage beyond the liability provisions described.

Other information

Siemens reserves the right to make changes to the application examples at any time without notice. In case of discrepancies between the suggestions in the application examples and other Siemens publications such as catalogs, the content of the other documentation shall have precedence.

The Siemens terms of use (<https://support.industry.siemens.com>) shall also apply.

Security information

Siemens provides products and solutions with Industrial Security functions that support the secure operation of plants, systems, machines and networks.

In order to protect plants, systems, machines and networks against cyber threats, it is necessary to implement – and continuously maintain – a holistic, state-of-the-art industrial security concept. Siemens' products and solutions constitute one element of such a concept.

Customers are responsible for preventing unauthorized access to their plants, systems, machines and networks. Such systems, machines and components should only be connected to an enterprise network or the Internet if and to the extent such a connection is necessary and only when appropriate security measures (e.g. firewalls and/or network segmentation) are in place.

For additional information on industrial security measures that may be implemented, please visit <https://www.siemens.com/industrialsecurity>.

Siemens' products and solutions undergo continuous development to make them more secure. Siemens strongly recommends that product updates are applied as soon as they are available and that the latest product versions are used. Use of product versions that are no longer supported, and failure to apply the latest updates may increase customer's exposure to cyber threats.

To stay informed about product updates, subscribe to the Siemens Industrial Security RSS Feed at: <https://www.siemens.com/industrialsecurity>.

Table of contents

Legal information	2
1 Task	5
1.1 Overview.....	5
1.2 Requirements.....	6
2 Solution	7
2.1 Overview of the overall solution	7
2.2 Description of the core functionality	9
2.3 Minimum requirements for the hardware/software.....	14
2.4 Hardware and software components used.....	14
2.5 Memory requirement of the blocks (S7-1500).....	15
3 Fundamentals	16
3.1 Cyclic communication.....	16
3.2 Acyclic communication – data block 47	17
3.3 Basic principles of the basic positioner	18
3.4 Mode selection of the basic positioner	18
4 General overview	21
5 Function block SINA_POS (FB284)	22
5.1.1 Description	23
5.1.2 Calling OBs	23
5.1.3 Called blocks	23
5.1.4 Function description – general	23
5.1.5 Input interface SINA_POS.....	24
5.1.6 Description of the configuration input "ConfigEPos"	25
5.1.7 Output interface SINA_POS.....	26
5.1.8 Comparison of the interfaces of SINA_POS old (<V14) and new (≥V14).....	28
5.2 Mode selection of EPos with SINA_POS	30
5.2.1 Relative positioning	31
5.2.2 Absolute positioning	32
5.2.3 Setup mode	34
5.2.4 Continuous setpoint acceptance	35
5.2.5 Referencing – reference point approach.....	36
5.2.6 Referencing – set reference point	37
5.2.7 Traversing blocks	38
5.2.8 Jog.....	40
5.2.9 Incremental jogging	42
5.2.10 Flying referencing	43
5.2.11 Change of operating mode based on the "ModePos" values	44
5.2.12 Troubleshooting the SINA_POS function block	45
6 Function block SINA_SPEED (FB285)	46
6.1.1 Description	46
6.1.2 Calling OBs	46
6.1.3 Called blocks	47
6.1.4 Function description – general	47
6.1.5 Input interface SINA_SPEED.....	47
6.1.6 Default setting of the ConfigAxis input	48
6.1.7 Output interface SINA_SPEED	48
6.1.8 Comparison of the interfaces of SINA_SPEED old (<V14) and new (≥V14)	49
6.1.9 Troubleshooting the SINA_SPEED function block.....	50

7	Function block SINA_PARA (FB286)	51
7.1.1	Input interface of SINA_PARA	52
7.1.2	Output interface of SINA_PARA	52
7.1.3	Data structure of the "sxParameter" area	54
7.1.4	Writing to parameters	55
7.1.5	Reading parameters	55
7.1.6	Troubleshooting function block SINA_PARA	56
7.2	Connection to the LAcycCom library	58
8	Function block SINA_PARA_S (FB287)	60
8.1.1	Input interface of SINA_PARA_S	61
8.1.2	Output interface of the FB287	61
8.1.3	Using the various parameter inputs and outputs	62
8.1.4	Writing to parameters	62
8.1.5	Reading parameters	63
8.1.6	Troubleshooting function block SINA_PARA_S	63
9	Function block SINA_INFEED (FB288)	65
9.1.1	Function description	66
9.1.2	Input interface of SINA_INFEED	66
9.1.3	Default setting of the ConfigAxis input	67
9.1.4	Output interface of SINA_INFEED	67
9.1.5	Troubleshooting function block SINA_INFEED	68
10	Configuration and project engineering	69
10.1	Configuring a SIMATIC controller S7-1200/1500 with SINAMICS G120 (Startdrive configuration)	69
10.2	Configuring the SIMATIC S7-1200/1500 controller with SINAMICS S120 (GSD configuring)	73
10.3	Selection of the correct hardware submodules	75
10.4	Configuration of the SIMATIC controller S7-300/400 with SINAMICS G120 (Startdrive and GSD configuration)	79
10.5	Configuration of the blocks	84
10.5.1	Installing the block library up to and including TIA Portal V13SP1	84
10.5.2	Inserting the blocks in the project	87
10.5.3	Installing the block library up to and including TIA Portal V14	90
11	Examples of acyclic communication with SINA_PARA (FB286)	94
11.1	Copy RAM to ROM	94
11.2	Absolute encoder adjustment	94
11.3	Writing the up/down ramp of the ramp-function generator	95
11.4	Jog velocity / incremental distance	95
11.5	Reading the actual fault buffer	97
12	Appendix	99
12.1	EPos telegram 111	99
12.2	Standard telegram 1	106
13	References	108
13.1	References	108
13.2	Internet links	108
14	History	109

1 Task

1.1 Overview

Introduction

The function blocks for the cyclic and acyclic communication are used for the simple connection of various SINAMICS S/G/V converter systems.

Each communication block can be used for an axis of a SINAMICS S120 multi-axis or a SINAMICS S110, Sinamics V90 or G120x converter system.

The supported communication paths are intended for PROFIBUS and PROFINET bus systems.

Overview of the automation task

The following diagram provides an overview of the automation task.

Fig. 1-1

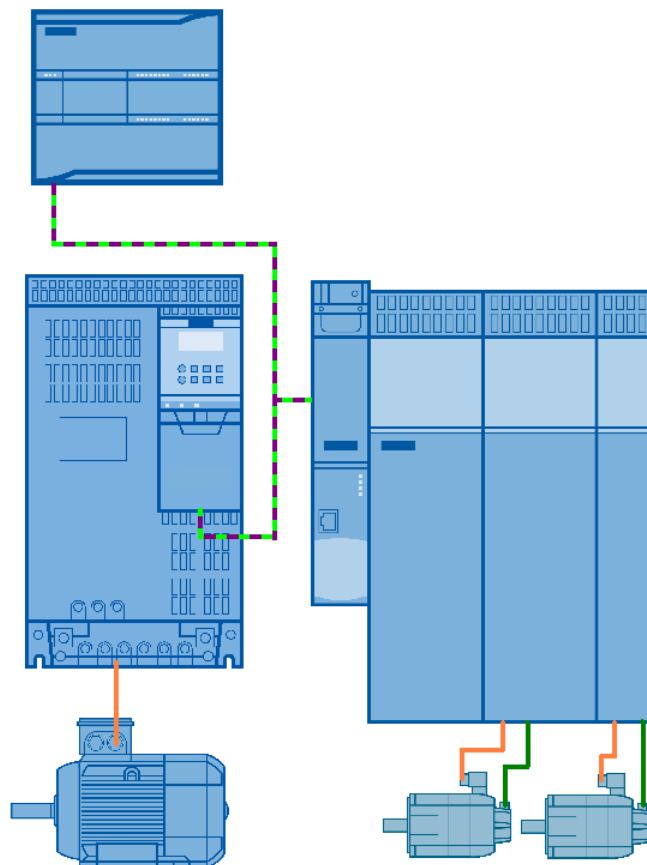

Description of the automation task

Depending on the type and use of the data, the data exchange between a SIMATIC S7 controller and a SINAMICS drive is performed **cyclically** – for process data – or **acyclically** – for adjustable parameters.

1.2 Requirements

Requirements of the automation task

Table 1-1

Requirement	Explanation
Cyclic transfer: Process data transfer	<ul style="list-style-type: none">- Fixed telegram length- No structural change during runtime- "Fast" data transfer
Acyclic transfer: Configuration data transfer Commissioning interface Diagnostics	<ul style="list-style-type: none">- Variable telegram length- Variable structural change- "Slow" data transfer- All parameters can be read

2 Solution

2.1 Overview of the overall solution

Schematic

The following schematic diagram shows the most important components of the solution:

Fig. 2-1

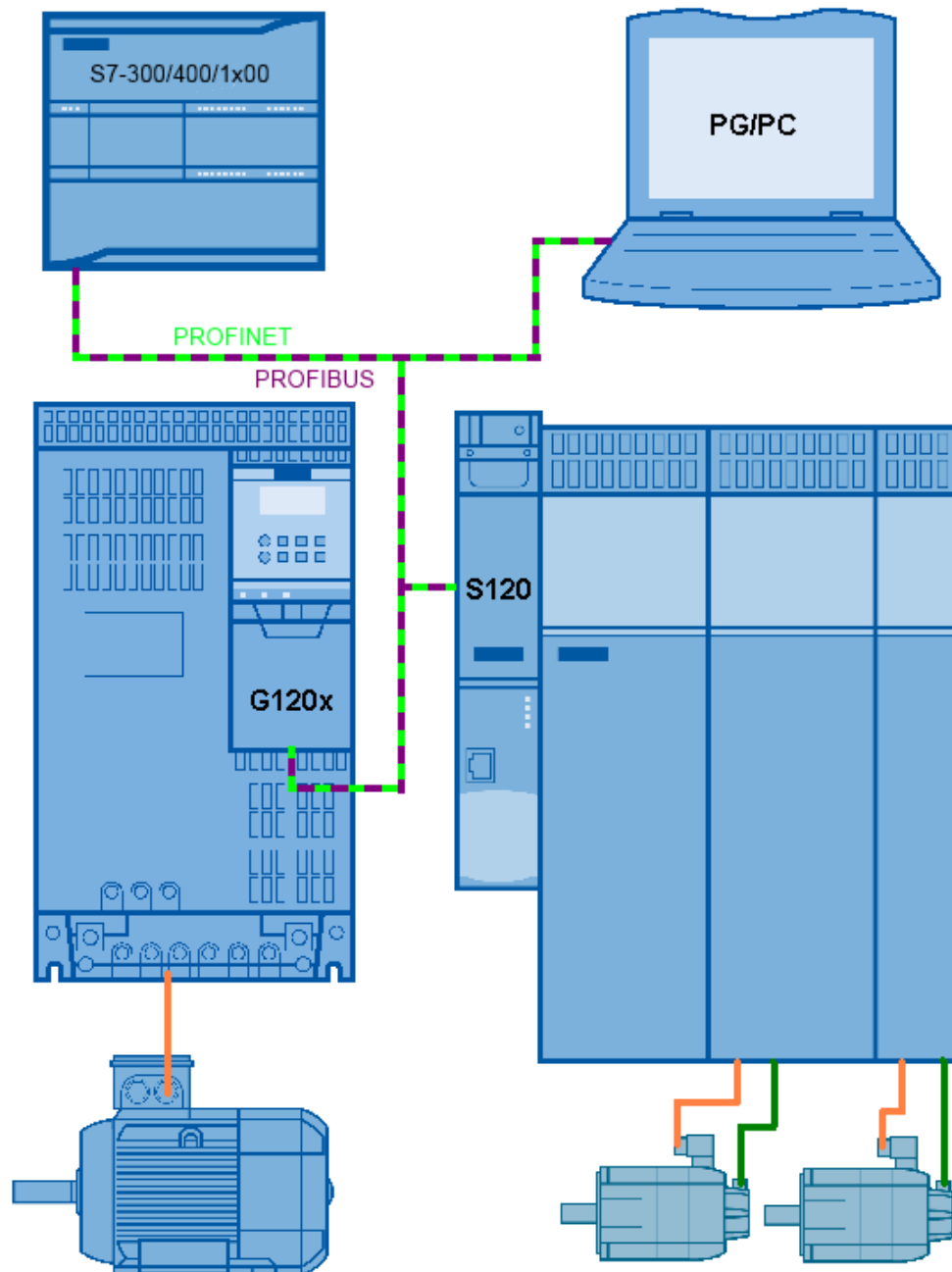

Design

The configuration of the function blocks is performed in the TIA Portal as of V12 SP1.

The configuration and parameter settings for the drives is realized as follows

1. For SINAMICS G120, using Startdrive V12SP1+ (or using GSD and STARTER 4.x).
2. For SINAMICS S120, using Startdrive V*** (or using GSD and also STARTER 4.x).
3. For SINAMICS V90PN using the V wizard and corresponding GSD.

Note ***The final version of Startdrives is still not known at the time that this document was created.

Note The appropriate STARTER 4.x version must be selected depending on the firmware version used.

Benefits

This software package offers you the following advantages:

- The SIMATIC S7 PLC can simply use the EPos functionality
- Simpler parameter access from the SIMATIC S7 PLC
- A speed-controlled axis can be simply controlled
- Blocks can be intuitively interconnected
- Preconfigured function and data blocks
- Modular software package that can be adapted by the customer

Demarcation

This block documentation does not contain a description of

- The drive commissioning/optimization
- The commissioning/selection of the PG/PC interface
- The use of technology objects by the SIMATIC S7-1200/1500

Knowledge required

Basic knowledge of the TIA Portal, SINAMICS commissioning in Startdrive (STARTER) as well as the basic positioner (EPos) is required.

2.2 Description of the core functionality

The software package is divided into 5 function blocks, which provide the various communication paths to the different technology axes on a SINAMICS drive system.

The speed-controlled and position-controlled axes are integrated by means of predefined telegrams including preconfigured instance data blocks.

1. The integration of a speed-controlled axis by means of standard telegram 1 in the SINA_SPEED function block (FB285).
2. The integration of a position-controlled axis by means of standard telegram 111 in the SINA_POS function block (FB284).
3. The integration of an infeed device (BLM / SLM / ALM – only S120) connected via Drive Cliq by means of standard telegram 370 in the SINA_INFEED function block (FB288).
4. The acyclic communication is established according to the PROFIdrive profile using data block 47, and is implemented in the SINA_PARA (FB286) or SINA_PARA_S (FB287) function block.

Function block FB284 (SINA_POS) has an input and output interface from the application view. The function block provides the available operating modes of the EPos via a predefined interface. The main focus is on a useful limitation of the displayed variables of telegram 111, whereby not all variables of the telegram are **individually** displayed at the block interface. However, at the same time, access to the entire **setpoint interface** of telegram 111 is always possible via the **input range**.

The speed block FB285 (SINA_SPEED) has an input and output interface for simple speed input / evaluation. The user must provide the function block with the rated speed (p2000) set in the SINAMICS drive. However, at the same time, access to the entire setpoint interface of telegram 1 is always possible via the input range.

The infeed block FB288 (SINA_INFEED) has an input and output interface to simply control and evaluate an infeed unit connected via DriveCliq. Telegram 370 is used for control. However, at the same time, access to the entire setpoint interface of telegram 370 is always possible via the input range.

The acyclic communication block FB286 (SINA_PARA) provides the user with a predefined interface for simply reading and writing 16 arbitrary SINAMICS drive parameters. The user only has to specify the parameter numbers, a possible index and – for writing – a parameter value^(*1). The job processing is performed autonomously after the job is started.

The acyclic communication block FB287 (SINA_PARA_S) provides the user with a predefined interface for simply reading and writing any arbitrary SINAMICS drive parameters. The user only has to specify the parameter numbers, a possible index and – for writing – a parameter value^(*1). The job processing is performed autonomously after the job is started.

Note

(*1) Within the scope of the Startdrive V14 update, the SINA_PARA and SINA_PARA_S blocks are assigned an additional input and output field in the DINT format for each job field. This is realized in addition to the previous request slot into the REAL format.

With this extension, it is now possible to transfer parameters in the DINT format without restricting rounding off.

This is especially necessary when reading and writing and for BICO parameters.

The external (logic) connection of the function blocks must be performed by the user. This includes, for example, the mode selection for FB284 (SINA_POS), the speed setpoint for FB285 (SINA_SPEED) as well as the filling/evaluation of the data interface of FB286 (SINA_PARA).

Sequence of the core functionality

Simplified state diagram for the EPos mode selection – FB284 (SINA_POS)

Fig. 2-2

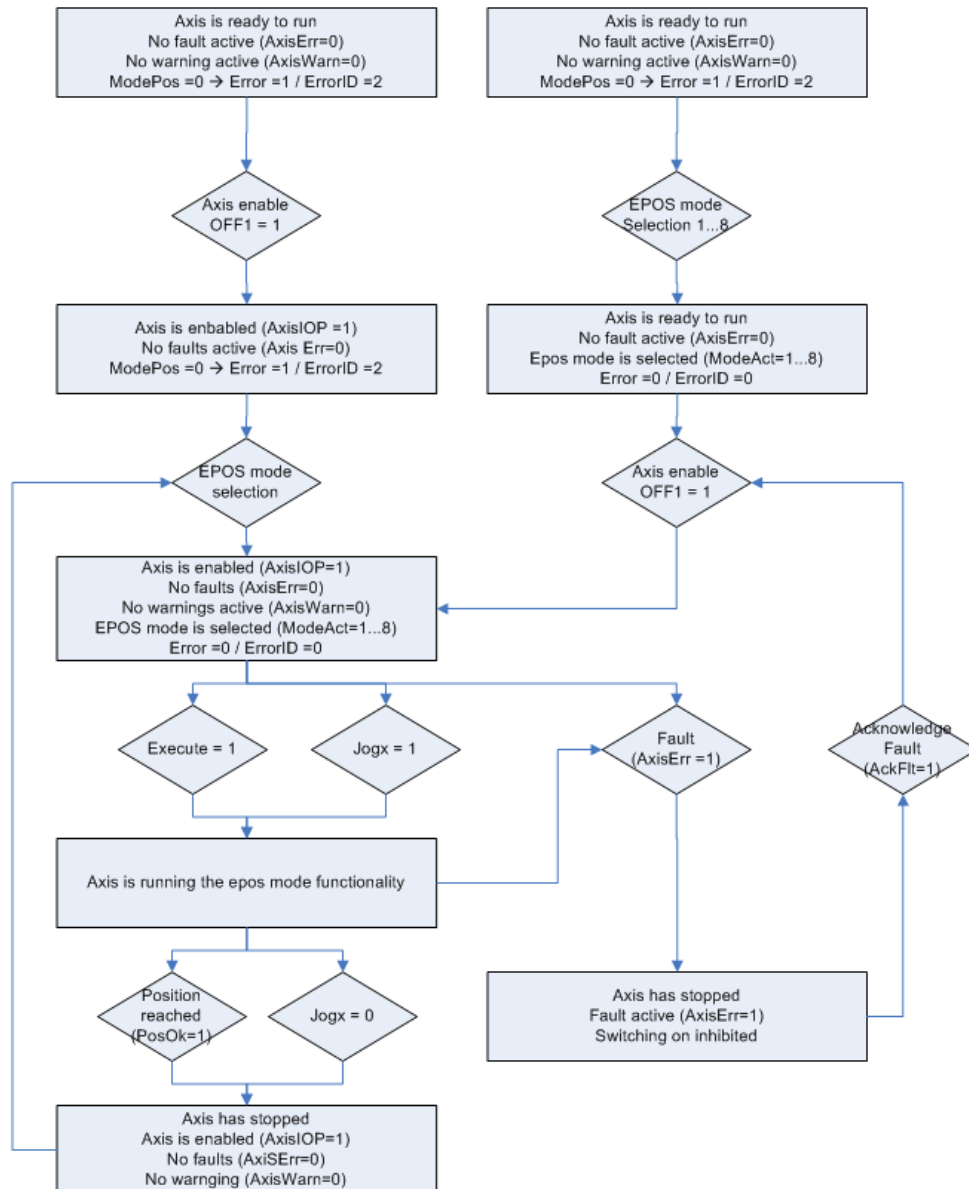

Table 2-1

	Action	Note
1.	Switching on the axis or selecting the EPos operating mode	An active fault must not be present / an active alarm should not be present
2.	Start selected operating mode	- Traversing blocks, positioning and referencing use the "Execute" input - Jog mode uses Jog1 or Jog2
3.	Operating mode is performed and then terminated	End of the operating mode when the position setpoint is reached / termination through reject traversing task / deselection of the "Jog" input

General state diagram for speed block FB285 (SINA_SPEED)

Fig. 2-3

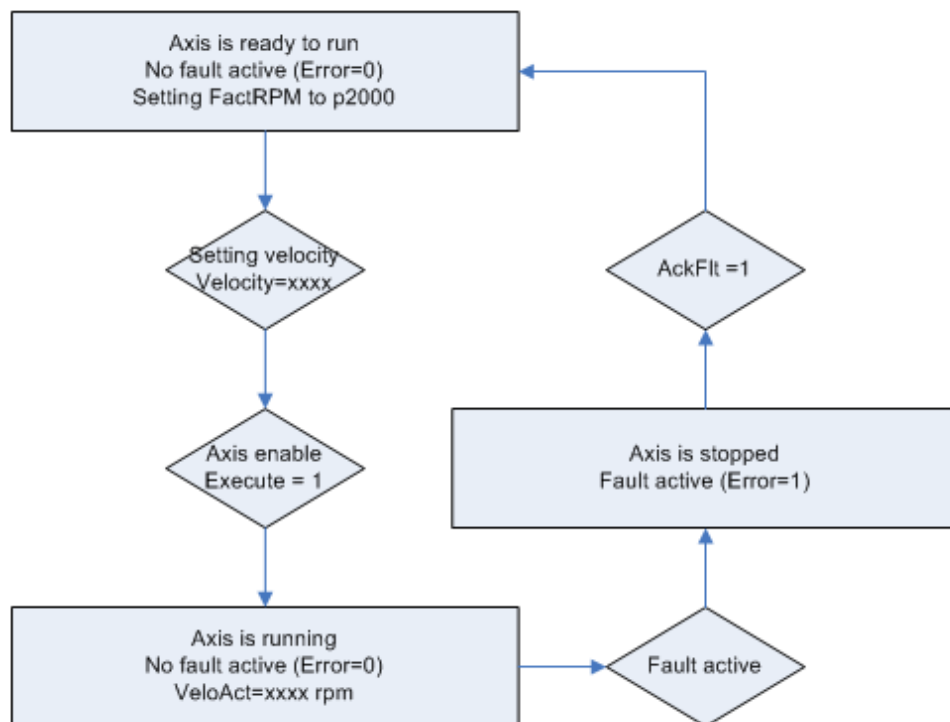

Table 2-2

Action	Note
Entry of the scaling speed (see p2000 in the SINAMICS drive)	Specification of the real speed setpoint as block input is possible
Speed setpoint input	Input of the speed setpoint
Axis is switched on using "EnableAxis" =1	No fault active / axis is traversed

General state diagram for the acyclic block FB286/287 (SINA_PARA or SINA_PARA_S)

Fig. 2-4

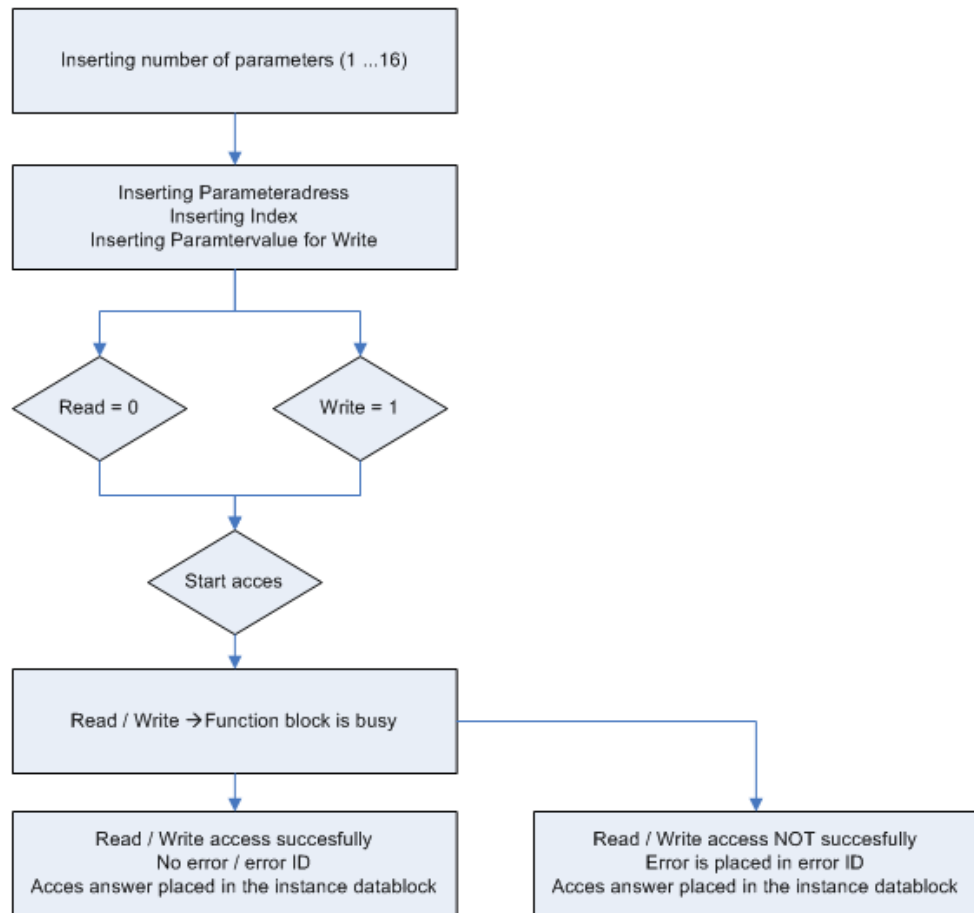

Table 2-3

Action	Note
Entry of the number of parameters	1 to 16 parameters are possible
Entry of the parameter numbers, index, parameter value	Entry in the intended area of the instance data block
Read or write	Read = 0, write = 1
Start of the job	Edge from 0 → 1
Evaluation of the job response	With incorrect jobs, there is an "Error bit" and an "Error ID"

2.3 Minimum requirements for the hardware/software

NOTICE	<ul style="list-style-type: none"> • The block library can only be used as of software version <u>TIA Portal V12 SP1</u> including <u>STEP 7 V12 SP1</u>. • The firmware of the S7-300 MUST be at least 2.x. • The firmware of the S7-1200 MUST be at least 2.x. • The firmware of the S7-1500 MUST be at least 1.1
---------------	--

NOTICE		STEP7 V12 SP1 / V13 / V14	
	Block access	Not optimized	Optimized
	SINA_POS	≤ V2.9	≥ 4.0
	SINA_PARA	≤ V2.9	≥ 4.0
	SINA_SPEED	≤ V2.5	≥ 4.0
	SINA_PARA_S	-	≥ 4.0
	SINA_INFEED	-	≥ 4.3 (from STEP7 V14)

2.4 Hardware and software components used

The blocks were created and tested with the following components:

Hardware components

Table 2-4

Component	Qty.	Order number	Note
S7-300	1	6ES7315-2EH14-0AB0	FW 3.2
S7-1200	1	6ES7-214-1AE30-0X80	FW 3.0
S7-1500	1	6ES7-516-3AN00-0AB0	FW 1.1

Standard software components

Table 2-5

Component	Qty.	Order number	Note
TIA Portal V14	1	6ES7822-1AA04-0YA5	Advanced/Professional
TIA Portal V13	1	6ES7822-1AA03-0YA5	Advanced/Professional
Startdrive V13	1	6SL3072-4DA02-0XG0	
TIA Portal V12SP1	1	6ES7822-1AA02-0YA5	Advanced/Professional
Startdrive V12SP1	1	6SL3072-4CA02-1XG0	

Sample files and projects

The list below contains all the files and projects used in this example.

Table 2-6

Component	Note
DriveLib_S71200_1500_V14	Block library
DriveLib_S7300_V13	Block library
DriveLib_S7400_V13	Block library
DriveLib_S71200_V13	Block library
DriveLib_S71200_V4_V13	Block library
DriveLib_S71500_V13	Block library
DriveLib_S71200_V12_SP1	Block library
DriveLib_S71500_V12_SP1	Block library
SINAMICS_blocks_TIA_Portal	This document.

2.5 Memory requirement of the blocks (S7-1500)

Table 2-7

Block	Load memory	Work memory
SINA_SPEED	16717 bytes	941 bytes
SINA_POS	90016 bytes	6873 bytes
SINA_INFEED	15964 bytes	1092 bytes
SINA_PARA	157234 bytes	16411 bytes
SINA_PARA_S	93871 bytes	7129 bytes

3 Fundamentals

3.1 Cyclic communication

Process data is transferred cyclically, i.e. in each bus cycle. Depending on the bus system used, isochronous or non-isochronous data transfer is possible. In principle, the cyclic communication is a time-critical application.

The SIMATIC S7 controller sends control words and setpoints to the SINAMICS drive and receives status words and actual values from the SINAMICS drive.

With regard to use in the SINAMICS drive, the telegram structure is set by means of predefined standard telegrams according to the PROFIdrive profile or manufacturer-specific telegrams.

Depending on the telegram type, a different number of setpoints or actual values or extended control or status words are transferred. The telegram length as well as the links in the SINAMICS drive are fixed in during operation and cannot be changed.

- On the SIMATIC S7 controller side, the process data is provided as peripheral input or output words.
- Which control word bits and which data should be sent to the SIMATIC S7 controller is defined in the SINAMICS drive by the parameterization.
- A wide range of standard functions and function blocks are available for the data exchange in the SIMATIC controllers.

Note

A detailed description of the cyclic communication can be found in the Function Manual, **(FH1), 07/2016, 6SL3097-4AB00-0AP5** of the SINAMICS S120 in Chapter 11. ([3/](#))

The manual is also saved in SIOS:

<https://support.industry.siemens.com/cs/ww/de/view/109740020>

3.2 Acyclic communication – data block 47

Fig. 3-1

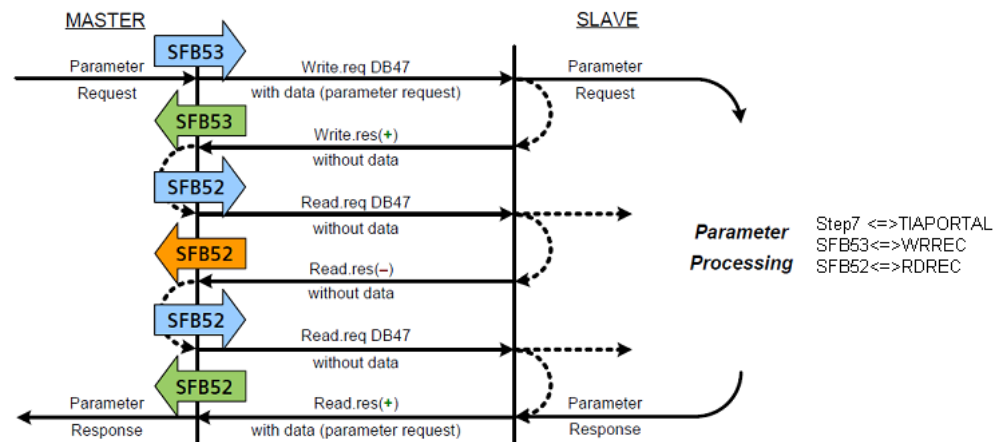

It is possible to acyclically transfer the parameter area when required, without creating a permanent communication load (communication overhead). The acyclic transfer takes significantly longer than the cyclic transfer of the processed data, however, larger data quantities can be transferred.

- In the SIMATIC controller, read and write jobs are initiated via the standard function blocks SFB52/53 – or RDREC and WRREC.
- A read job always starts with a write job which informs the addressed node which values are to be determined. The actual read job is then performed.
- No special action is required on the SINAMICS drive side.

Decisive for a functioning acyclic communication is the creation of a job profile corresponding to the data block used.

The response to write and read jobs must also be transferred in appropriate data block structures and evaluated.

For read and write jobs that do not change, the structure can be defined beforehand. However, if the jobs vary and the contents are different, this can only be mapped in a general structure and must be evaluated separately by the user.

Note

A detailed description of the cyclic communication can be found in the Function Manual, (FH1), 07/2016, 6SL3097-4AB00-0AP5 of the SINAMICS S120 in Chapter 11. ([3/](#)). The manual is also saved in SIOS:

<https://support.industry.siemens.com/cs/ww/de/view/109740020>

Additional information with regard to data block 47 can be found in the PROFIdrive Manual, Edition 2006.

3.3 Basic principles of the basic positioner

The basic positioner (EPos) is a very comprehensive and powerful function module for position-controlled traversing of an electric drive.

It is used for absolute and relative positioning of linear and rotary axes (modulo) with motor encoders (indirect measuring system) or machine encoders (direct measuring system).

It can be activated in various drives of the SINAMICS S/G converter series as a function module.

User-friendly configuration, commissioning and diagnostic functions for the EPos functionality are also available in the STARTER or Startdrive parameterization software.

The position controller is also activated when activating the basic positioner. This is performed automatically via drive wizards. Further, the necessary "internal interconnections" (BICO technology) are automatically established, which are required between the EPos and position controller (e.g. setpoints from the EPos for closed-loop position control, axis cycle correction, etc.).

The closed-loop position control essentially comprises the following parts:

- Actual position value processing (including the lower-level probe evaluation and reference mark search)
- Position controller (including limits, adaptation and pre-control calculation)
- Monitoring functions (standstill, positioning and dynamic following error monitoring, output cam signals)

In addition, the following functions can be carried out using the basic positioner:

Mechanical design:

- Backlash compensation
- Modulo offset
- Position tracking / limits
- Velocity/acceleration/deceleration limits
- Software limit switches (traversing range limitation using position setpoint evaluation)
- Stop cams (traversing range limitation using hardware limit switch evaluation)
- Positioning/standstill monitoring
- Following error monitoring
- Two cam switching signals

NOTE

Detailed descriptions can be found in the Basic Positioner Function Manual, 01/2013, FW V4.6, A5E31759509A AA

3.4 Mode selection of the basic positioner

The following extract from the List Manual graphically illustrates the mode selection of the basic positioner (EPos):

Figure 3-2

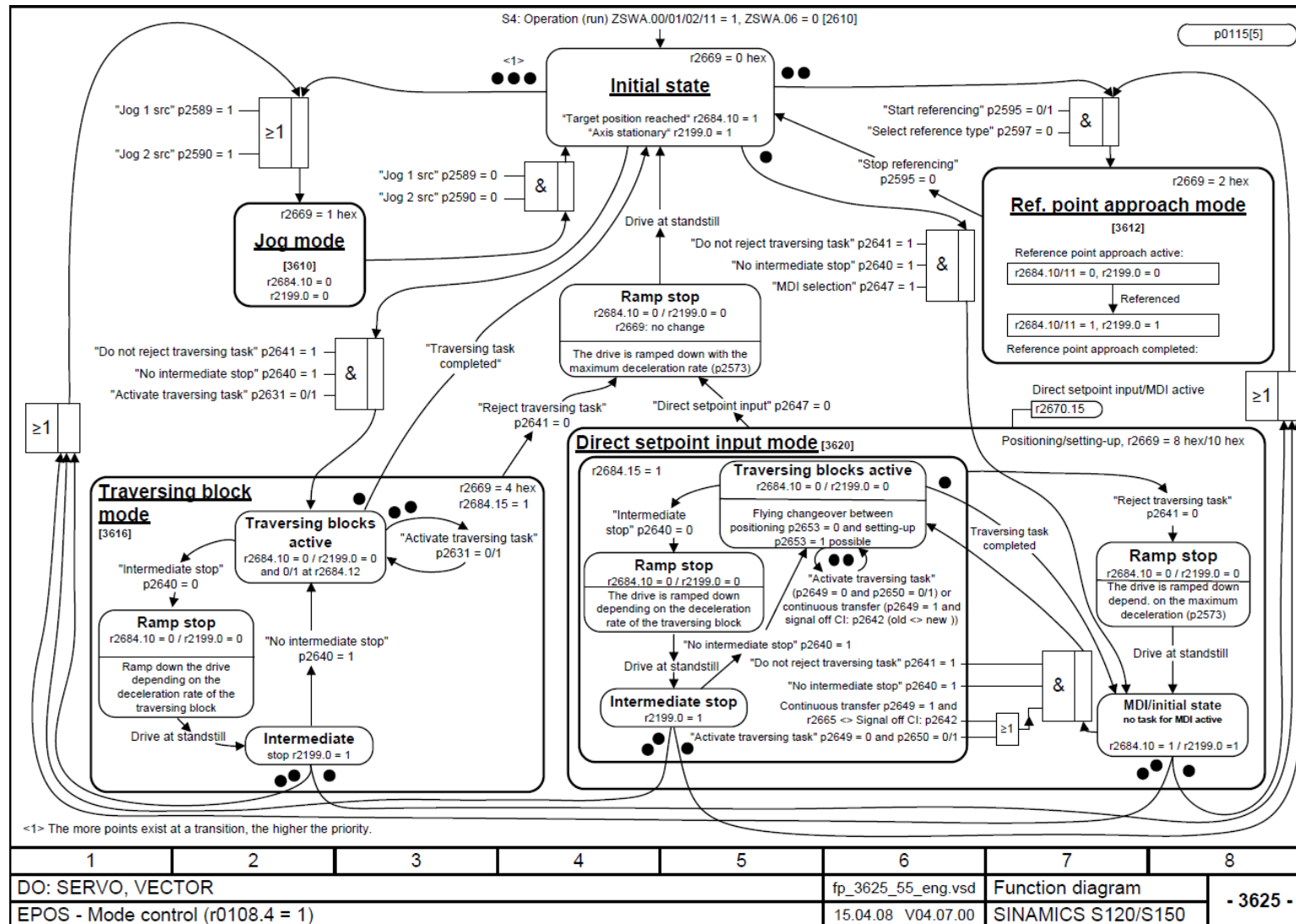

The mode selection is decisive for the execution of the required functions. The EPos modes are structured hierarchically and the following order applies when functions are selected simultaneously:

Jog >> Reference point approach >> MDI setpoint input >> Traversing blocks

4 General overview

The following figure shows the various calls of the different blocks – see the sample documentation SINAMICS S120, Chapter 4/5

Fig. 4-1

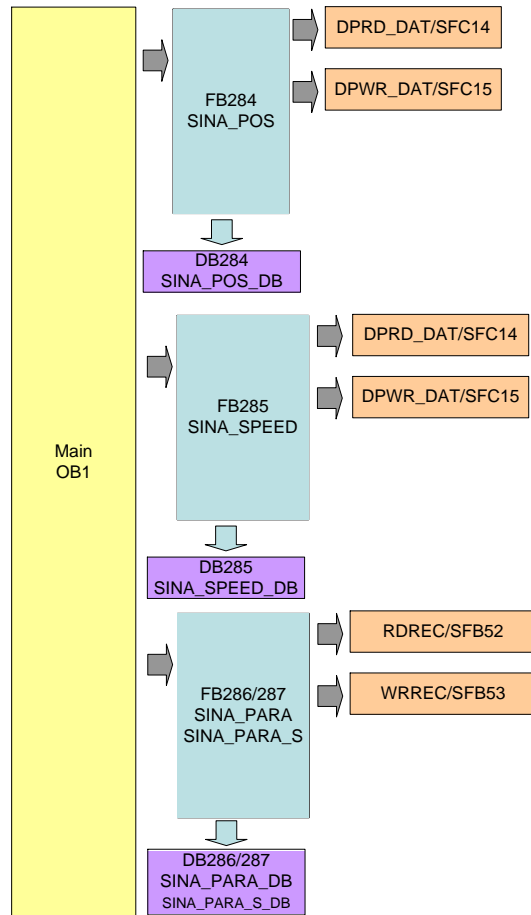
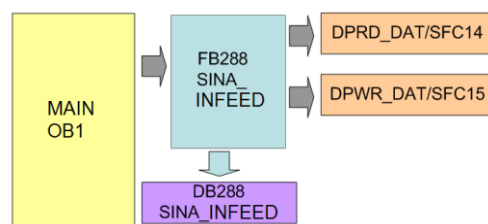

Fig. 4-2



The SIMATIC S7-300/400/1x00 program comprises the following areas:

1. Cyclic process data exchange – SINA_POS (FB284), SINA_SPEED (FB285), SINA_INFEED (FB288):
In this area, process data is sent to the SINAMICS S/G (e.g. on command and position setpoint) or received (status and actual values).
2. Acyclic parameter access – SINA_PARA/SINA_PARA_S (FB286/287):
Parameters of the SINAMICS S/G are accessed in this area (e.g. reading or writing traversing blocks).

5 Function block SINA_POS (FB284)

Fig. 5-1(S7 1200/1500 CPU)

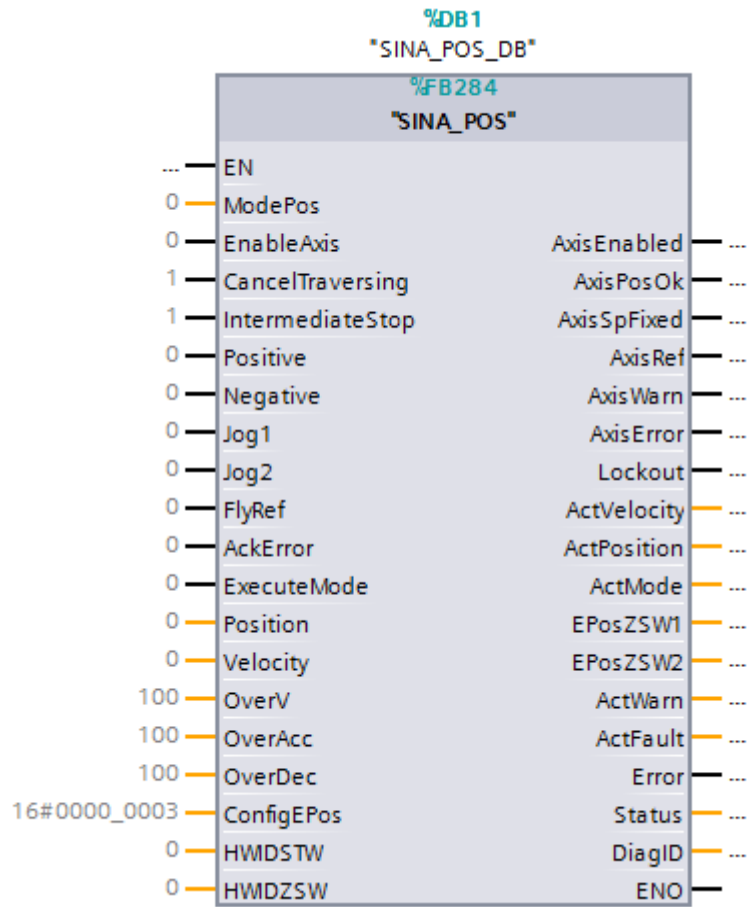
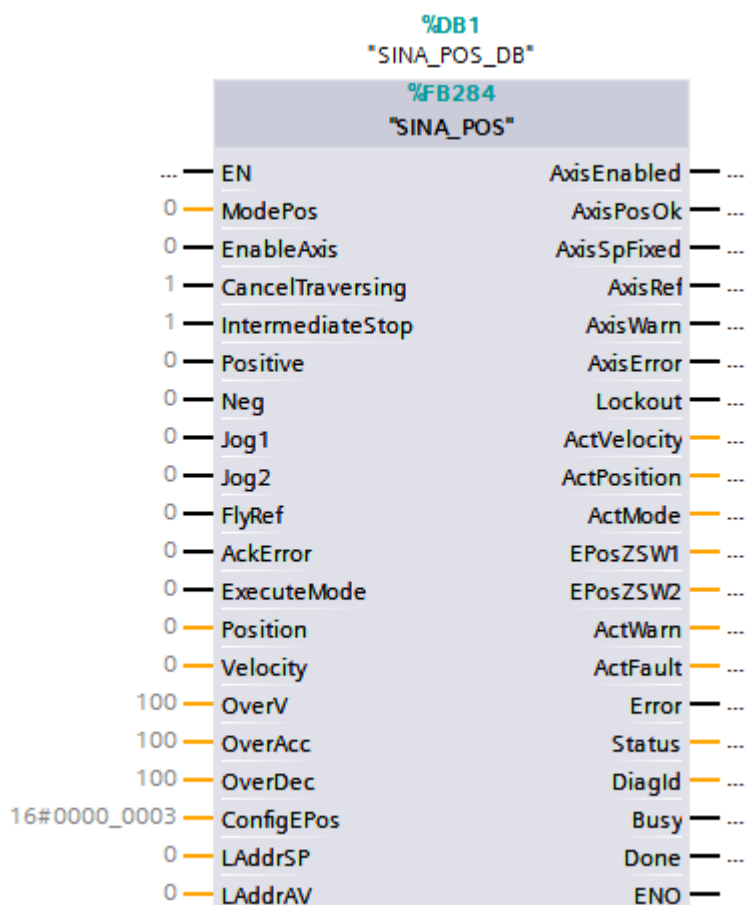

Fig. 5-2(S7 300/400 CPU)



5.1.1 Description

The appropriate instance DB is automatically created with the integration of FB284 (SINA_POS).

Can be used in the following CPUs: SIMATIC S7-300/400/1200/1500

5.1.2 Calling OBs

The block can be inserted alternatively in the following OBs:

- Cyclic task: OB1
- Cyclic interrupt OB: e.g. OB32

5.1.3 Called blocks

DPRD_DAT/SFC14

DPWR_DAT/SFC15

5.1.4 Function description – general

With the function block, a SINAMICS drive can be controlled cyclically with the basic positioner technology of the SINAMICS S/G type.

NOTICE	<p>Because of the various EPos modes, there is a special mode input – the "ModePos" input. The individual operating modes are selected via this input. Because of the EPos structure, it is therefore not possible to select different operating modes simultaneously. However, it is possible to change to different modes within an operating mode at any time, e.g. setup mode with change to absolute positioning.</p> <p>Detailed information can be found in Chapter 5.2.</p>
---------------	---

NOTICE	<p>To control all additional bits in the setpoint direction without an explicit input, from TIA Portal / Startdrive V14 an additional configuration input is available – the "ConfigEPos" input. Using this input, it is now possible to activate basic device functions such as OFF2/OFF3 – or also EPos functions such as continuous setpoint transfer – WITHOUT having to intervene in the instance data block using a SLICE access.</p>
---------------	---

NOTICE	<p>Standard telegram 111 must be selected for the communication when configuring the SINAMICS drive.</p>
---------------	--

5.1.5 Input interface SINA_POS

The input interface consists of 19 inputs with various data formats.

When the function block is first configured, the inputs are set up with initial values. An overview of the input interface is subsequently shown (name changes from TIA V14 are marked in green):

Table 5-1

Input signal	Type	Default[...]	Meaning
ModePos	INT	0	Operating mode: 1 = relative positioning 2 = absolute positioning 3 = positioning as setup 4 = reference point approach 5 = set reference point 6 = traversing block 0 – 15/63 (G120/S120) 7 = jog mode 8 = incremental jogging
EnableAxis	BOOL	0	Switching command: 0 = OFF1, 1 = ON
CancelTraversing	BOOL	1	0 = reject active traversing task, 1 = do not reject
IntermediateStop	BOOL	1	0 = active traversing command is interrupted, 1 = no intermediate stop
Positive	BOOL	0	Positive direction
Negative	BOOL	0	Negative direction
Jog1	BOOL	0	Jog signal source 1
Jog2	BOOL	0	Jog signal source 2
FlyRef	BOOL	0	0 = deselect flying referencing, 1 = select flying referencing
AckError	BOOL	0	Acknowledging errors

Input signal	Type	Default[...]	Meaning
ExecuteMode	BOOL	0	Activate traversing task / setpoint acceptance / activate reference function
Position	DINT	0[LU]	Position setpoint in [LU] for direct setpoint input / MDI mode OR traversing block number for traversing block mode
Velocity	DINT	0[1000LU/min]	Velocity in [LU/min] for MDI mode
OverV	INT	100[%]	Velocity override active for all modes: 0-199%
OverAcc	INT	100[%]	Acceleration override active 0-100%
OverDec	INT	100[%]	Deceleration override active 0-100%
ConfigEPos	DWORD	3h	For a detailed description, refer to Chapter 5.2.1
HWIDSTW (Block S7-1200/1500)	HW_IO	0	Symbolic name or HW ID on the SIMATIC S7-1200/1500 of the setpoint slot → see Chapter 10.3
LAddrSP (Block S7-300/400)	HW_IO	0	Symbolic name or IO address on the SIMATIC S7-300/400 of the setpoint slot → see Chapter 10.4
HWIDZSW (Block S7-1200/1500)	HW_IO	0	Symbolic name or HW ID on the SIMATIC S7-1200/1500 of the actual value slot → see Chapter 10.3
LAddrAV (Block S7-300/400)	HW_IO	0	Symbolic name or IO address on the SIMATIC S7-300/400 of the actual value slot → see Chapter 10.4

5.1.6 Description of the configuration input "ConfigEPos"

Table 5-2

ConfigEPos	Meaning	PZD	Interconnection in the drive (telegram 111)	Default
Bit0	OFF2 (1 = no pulse inhibit)	1	r2090.1 = p 844[0]	1
Bit1	OFF3 (1 = no pulse inhibit)	1	r2090.2 = p 848[0]	1
Bit2	Software limit switch (active = 1)	3	r2092.14 = p2582	0
Bit3	Stop output cam (active = 1)	3	r2092.15 = p2568	0
Bit4	Probe edge evaluation	3	r2092.11 = p2511[0]	0
Bit5	Select probe	3	r2092.10 = p2510[0]	0
Bit6	Signal source reference mark	3	r2092.2 = p2612	0
Bit7	External block change (via BUS)	1	r2090.13 = p2633	0
Bit8	Continuous setpoint transfer MDI (active = 1)	2	r2091.12 = p2649	0
Bit9	DDS BIT0	4	r2093.0 = 820[0]	0
Bit10	DDS BIT1	4	r2093.1 = 821[0]	0
Bit11	DDS BIT2	4	r2093.2 = 822[0]	0
Bit12	DDS BIT3	4	r2093.3 = 823[0]	0
Bit13	DDS BIT4	4	r2093.4 = 824[0]	0
Bit14	Parking axis selection	4	r2093.7 = p897	0
Bit15				
Bit16	Reserve – can be used as required below	1	r2090.14	0
Bit17	Reserve – can be used as required below	1	r2090.15	0
Bit18	Reserve – can be used as required below	2	r2091.6	0

ConfigEPos	Meaning	PZD	Interconnection in the drive (telegram 111)	Default
Bit19	Reserve – can be used as required below	2	r2091.7	0
Bit20	Reserve – can be used as required below	2	r2091.11	0
Bit21	Reserve – can be used as required below	2	r2091.13	0
Bit22	Reserve – can be used as required below	3	r2092.3	0
Bit23	Reserve – can be used as required below	3	r2092.4	0
Bit24	Reserve – can be used as required below	3	r2092.6	0
Bit25	Reserve – can be used as required below	3	r2092.7	0
Bit26	Reserve – can be used as required below	3	r2092.12	0
Bit27	Reserve – can be used as required below	3	r2092.13	0
Bit28	Reserve – can be used as required below	4	r2093.5	0
Bit29	Reserve – can be used as required below	4	r2093.6	0
Bit30	Reserve – can be used as required below	4	r2093.8	0
Bit31	Reserve – can be used as required below	4	r2093.9	0

5.1.7 Output interface SINA_POS

The output interface consists of 16 outputs with various data formats.

When the block is first configured, the outputs are set up with initial values. The following is an overview of the output interface:

Table 5-3

Output signal	Type	Default[...]	Meaning
AxisEnabled	BOOL	0	Drive is ready and switched on
AxisPosOk	BOOL	0	Target position of the axis reached
AxisSpFixed	BOOL	0	1 = Setpoint is stationary (Note: Information is depending to SINAMICS firmware version: 1. SINAMICS S/G120 FW <4.8 / <4.7.9 transmission of parameter r2199.0 2. SINAMICS S/G120 FW ≥ 4.8 / ≥ 4.7.9 transmission of parameter r2683.2 3. SINAMICS V90 PN transmission of parameter r2683.2)
AxisRef	BOOL	0	Reference point set
AxisWarn	BOOL	0	Drive alarm active
AxisError	BOOL	0	Drive is faulted
Lockout	BOOL	0	Switching-on inhibit
ActVelocity	DINT	0	Actual velocity (scaled 40000000h = 100% p2000)
ActPosition	DINT	0[LU]	Actual position in LU

Output signal	Type	Default[...]	Meaning
ActMode	INT	0	Currently active mode
EPosZSW1	WORD	0	Status of EPos ZSW1 (bit-granular)
EPosZSW2	WORD	0	Status of EPos ZSW2 (bit-granular)
ActWarn	WORD	0	Actual alarm number
ActFault	WORD	0	Actual fault number
Error	BOOL	0	1 = group fault active
Status	INT	0	16#7002: No fault – block is being executed 16#8401: Drive fault 16#8402: Switching-on inhibit 16#8403: flying referencing could not be started 16#8600: Error DPRD_DAT 16#8601: Error DPWR_DAT 16#8202: incorrect operating mode selected 16#8203: incorrect setpoints parameterized 16#8204: incorrect traversing block number selected
DiagID	WORD	0	Extended communication error → error during SFB call
Busy (Block S7-300/400)	BOOL	0	Mode is being executed or enabled
Done (Block S7-300/400)	BOOL	0	Mode has been executed error-free

5.1.8 Comparison of the interfaces of SINA_POS old (<V14) and new (≥V14)

Comparison of the input interface

Table 5-4

SINA_POS "OLD"	SINA_POS "NEW"	Comment SINA_POS "NEW"
ModePos	ModePos	No change
Off1	EnableAxis	Input has been renamed; Function remains the same
RejTrvTsk	CancelTraversing	Input has been renamed; Function remains the same
IntMStop	IntermediateStop	Input has been renamed; Function remains the same
Pos	Positive	Input has been renamed; Function remains the same
Neg	Negative	Input has been renamed; Function remains the same
Jog1	Jog1	No change
Jog2	Jog2	No change
FlyRef	FlyRef	No change
AckFlt	AckError	Input has been renamed; Function remains the same
Execute	ExecuteMode	Input has been renamed; Function remains the same
Position	Position	No change
Velocity	Velocity	No change
OverV	OverV	No change
OverAcc	OverAcc	No change
OverDec	OverDec	No change
----	ConfigEPos	New input to control the EPos functions not directly specified at the block See Chapter 5.1.6
LaddrSP	HWIDSTW	Input has been renamed; Function remains the same
LaddrAV	HWIDZSW	Input has been renamed; Function remains the same

Comparison output interface

Table 5-5

SINA_POS "OLD"	Position "OLD" → "NEW"	SINA_POS "NEW"	Comment SINA_POS "NEW"
Error	1 → 14	AxisEnabled	New position of the output; Output renamed; Function remains the same and represents the old output BUSY
ErrorId	2 → 15	AxisPosOk	New position of the output; Function remains the same and represents the old output DONE
Busy	3 → corresponds to "1"	AxisRef	New position of the output; Function remains the same
Done	4 → corresponds to "2"	AxisWarn	New position of the output; Function remains the same
AxisIOp	5 → 1	AxisError	New position of the output; Function remains the same
AxisErr	6 → 5	Lockout	New position of the output; Output renamed; Function remains the same
AxisWarn	7 → 4	ActVelocity	New position of the output; Output renamed; Function remains the same
AxisPosOk	8 → 2	ActPosition	New position of the output; Output renamed; Function remains the same
AxisRef	9 → 3	ActMode	New position of the output; Output renamed; Function remains the same
PwrInhibit	10 → 6	EPosZSW1	New position of the output; Function remains the same
VeloAct	11 → 7	EPosZSW2	New position of the output; Function remains the same
PosAct	12 → 8	ActWarn	New position of the output; Output renamed; Function remains the same
ModeAct	13 → 9	ActFault	New position of the output; Output renamed; Function remains the same
EPosZSW1	14 → 10	Error	New position of the output; Function remains the same
EPosZSW2	15 → 11	Status	New position of the output; Output renamed; Error values selected in the new PLC styleguide format; See Chapter 5.1.7
WarnAct	16 → 12	DiagID	New position of the output; Function remains the same
FaultAct	17 → 13		
DiagId	18 → 16		

5.2 Mode selection of EPos with SINA_POS

General operating conditions

The axis is switched on using input bit "EnableAxis" = 1. OFF2 and OFF3 are preassigned 1 using input "ConfigEPos" – and do not have to be written to for operation

The axis is ready to start when there is no error – "AxisError"= "0" – and no switching on inhibited – "Lockout" = "0". Feedback signal "AxisEnabled" goes to "1" after switching "EnableAxis".

The "ModePos" input is decisive for the mode selection. The required operating mode is selected via this input. A simultaneous, multiple mode selection is therefore not possible. However, it is possible to switch between various subordinate modes within the operating mode.

Example: Setup mode ("ModePos"=3) with flying change to absolute positioning ("ModePos"=2).

The input signals "CancelTraversing" (reject traversing task) and "IntermediateStop" (intermediate stop) are relevant for all modes except for jog and must be set to "1" when using EPos.

1. If the "CancelTraversing" bit is set to "0" this results in a ramp stop with 100% of the set deceleration. The task data is rejected and the axis can be assigned a new task from standstill. A mode change is possible in this state.
2. If the "IntermediateStop" bit is set to "0" this results in a ramp stop of the axis with the currently valid acceleration values. The task data is NOT rejected so that the axis continues with the motion when the bit is set to "1". A mode change is possible at standstill.
3. Apart from the reference point approach mode, the flying referencing function can be selected and deselected in any other mode using the "FlyRef" input.

5.2.1 Relative positioning

The **Relative positioning** mode is implemented via the "MDI relative positioning" drive function. It enables the position-controlled traversing of traversing paths using the integrated position controller of the SINAMICS drive.

1. Requirements:

- The mode is selected with ModePos=1.
- The device is switched on via "EnableAxis"
- The axis must **not** be referenced or the encoder adjusted.
- The axis is at standstill if selected by an operating mode greater than 3. A change within the MDI operating modes (1,2,3) is possible at any time.

2. Sequence:

The traversing path and dynamic responses are specified via the inputs "Position", "Velocity", "OverV" (velocity override), "OverAcc" (acceleration override) and "OverDec" (deceleration override).

The velocity override refers to the "Velocity".

The operating conditions "CancelTraversing" and "IntermediateStop" must be set to "1". "Jog1" and "Jog2" have no effect and should be set to "0" (false).

The direction of travel in relative positioning always results from the sign of the traversing path.

Traversing motion is started with a positive edge at "ExecuteMode". The current state of the active command can be tracked via "EPosZSW1 / EPosZSW2" (for details on the assignment of the PosZSW, see [Appendix](#)).

The block acknowledges when the end of the traversing path is reached successfully with "AxisPosOk". If an error occurs during the traversing motion, the output signal "Error" is issued.

Note

The current command can be replaced on-the-fly by a new command via "ExecuteMode". This is only possible for the "ModePos" 1, 2, 3 modes.

Example of relative positioning

Fig. 5-3

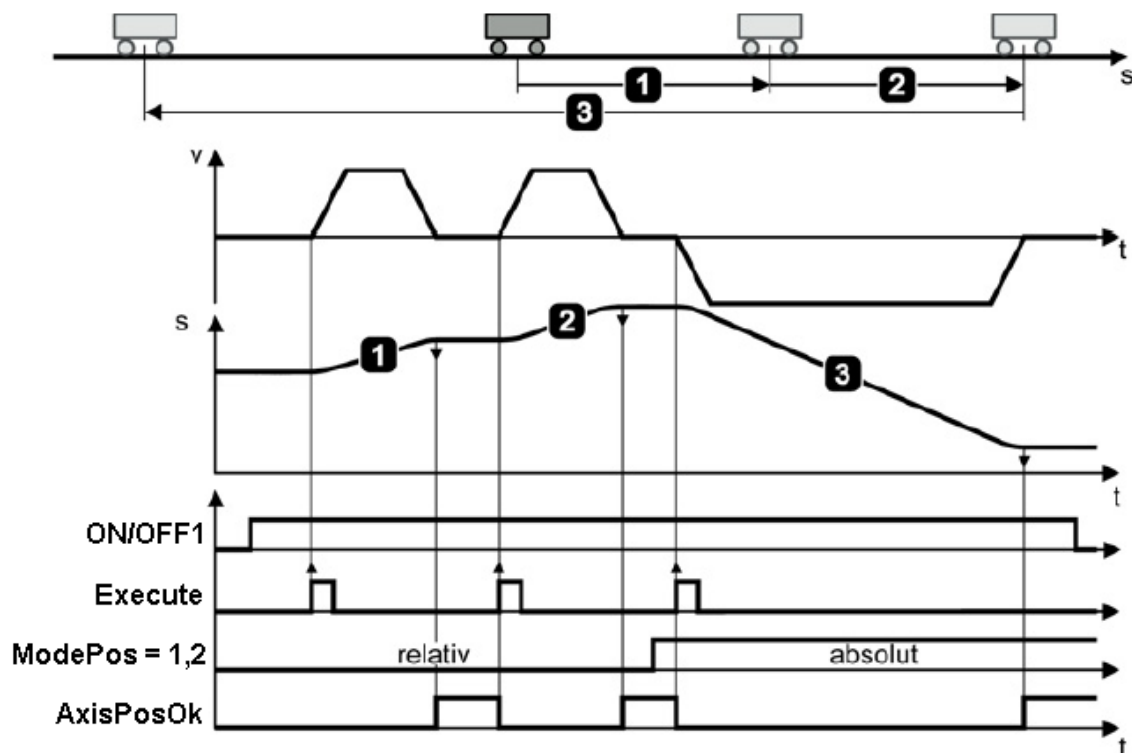

5.2.2 Absolute positioning

The **Absolute positioning** mode is implemented via the "MDI absolute positioning" drive function. It enables the position-controlled approach to absolute positions using the integrated position controller of the SINAMICS drive.

1. Requirements:

- The mode is selected with "ModePos"=2.
- The device is switched on via "EnableAxis"
- The axis must be referenced or the encoder adjusted
- The axis is at standstill if selected by an operating mode greater than 3. A change within the MDI operating modes (1,2,3) is possible at any time.

2. Sequence:

The traversing path and dynamic responses are specified via the inputs "Position", "Velocity", "OverV" (velocity override), "OverAcc" (acceleration override) and "OverDec" (deceleration override).

The velocity override refers to the "Velocity".

The operating conditions "CancelTraversing" and "IntermediateStop" must be set to "1". "Jog1" and "Jog2" have no effect and must be set to "0".

The direction of travel in absolute positioning always results from the shortest distance to the target position. The inputs "Positive" and "Negative" are "0".

Note If a preferred direction to approach the target position is to be specified for a modulo axis, this can be performed with "Positive" or "Negative".

Simultaneous selection of "Positive" and "Negative" immediately stops the axis with further alarms or faults. The selection has no effect for linear axes and is ignored.

Traversing motion is started with a positive edge at "ExecuteMode". The current state of the active command can be tracked via "EPosZSW1 / EPosZSW2" (for details on the assignment of the PosZSW, see [Appendix](#)).

The block acknowledges when the end of the traversing path is reached successfully with "AxisPosOk". If an error occurs during the traversing motion, the output signal "Error" is issued.

Note The current command can be replaced on-the-fly by a new command via "ExecuteMode". This is only possible for the "ModePos" 1, 2, 3 modes.

Example of absolute positioning

Fig. 5-4

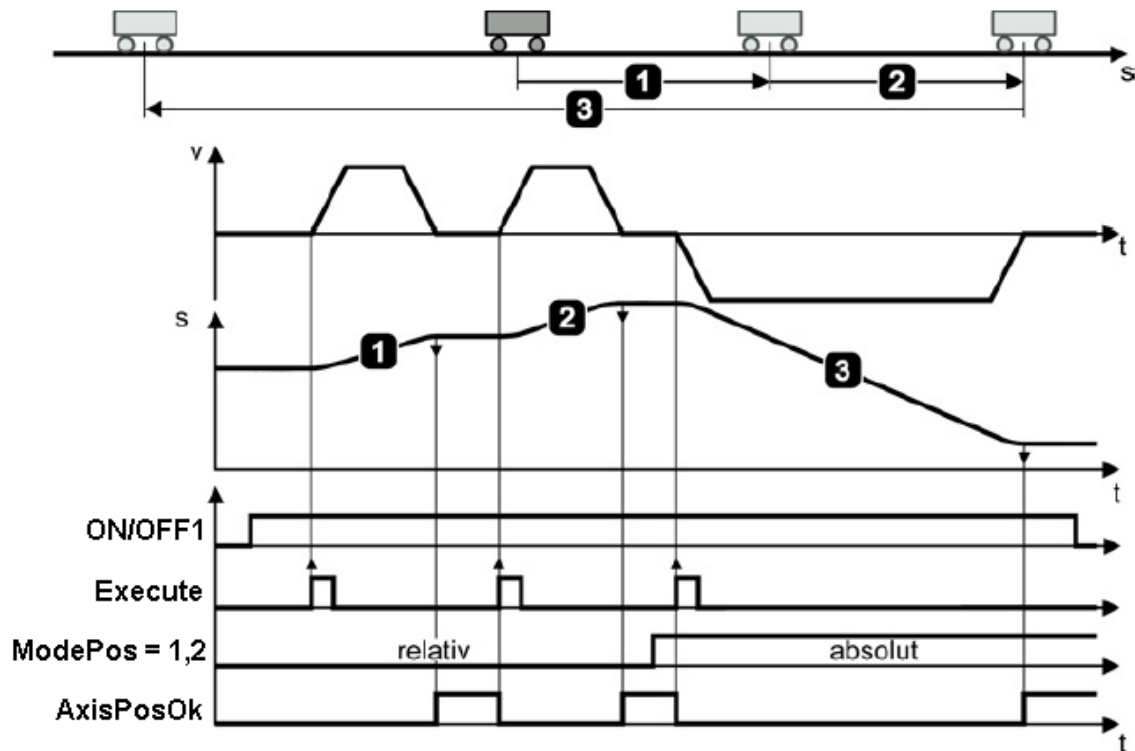

5.2.3 Setup mode

The **Setup mode** enables the position-controlled traversing of the axis in the positive or negative direction with constant velocity without specification of a target position via the "MDI set up" drive function.

1. Requirements:

- The mode is selected with "ModePos" = 3.
- The device is switched on using "EnableAxis".
- The axis must **not** be referenced or the encoder adjusted.
- The axis is at standstill if selected by an operating mode greater than 3. A change within the MDI operating modes (1,2,3) is possible at any time.

2. Sequence:

The traversing path and dynamic responses are specified via the inputs "Position", "Velocity", "OverV" (velocity override), "OverAcc" (acceleration override) and "OverDec" (deceleration override).

The operating conditions "CancelTraversing" and "IntermediateStop" must be set. "Jog1" and "Jog2" have no effect and must be set to "0".

The travel direction is determined via "Positive" and "Negative". Simultaneous selection stops the axis without further alarms or faults.

Traversing motion is started with a positive edge at "ExecuteMode". The current state of the active command can be tracked via "EPosZSW1 / EPosZSW2" (for details on the assignment of the PosZSW, see [Appendix](#)).

The output signal "AxisPosOk" is set when the setup mode is terminated with reject traversing task and the axis has stopped.

If an error occurs during the traversing motion, the output signal "Error" is issued.

Note

The current command can be replaced on-the-fly by a new command via "ExecuteMode". This is only possible for the "ModePos" 1, 2, 3 modes.

Example of setup mode

Fig. 5-5

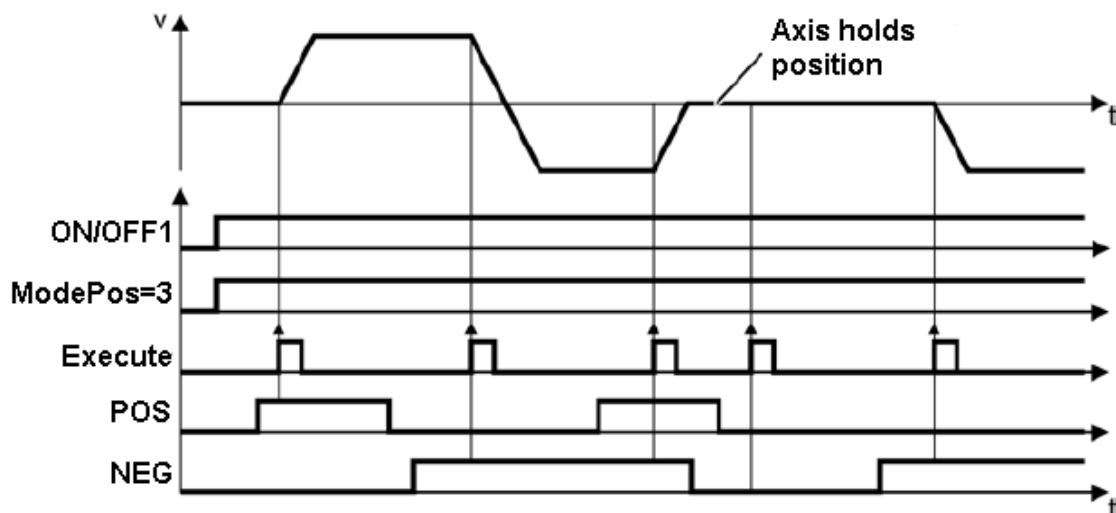

5.2.4 Continuous setpoint acceptance

NOTICE

The continuous setpoint acceptance represents a special function of the positioning mode. With parameter p2649 – in the standard telegram in EPos STW1 BIT12 – it is possible to accept the MDI set values (position, velocity,...) directly in the basic positioner WITHOUT edge triggering.

The "ConfigEPos" input is used to access.

Example: ConfigEPos = 3h (standard) → ConfigEPos = 103h

$259 = (3+(2^8))$ (with direct setpoint transfer) = 103h

5.2.5 Referencing – reference point approach

The **Referencing – reference point approach** mode enables the reference point approach of the axis in the positive or negative direction with preconfigured velocity and reference mode via the "Active referencing" drive function.

1. Requirements:

- The mode is selected with "ModePos"=4.
- The device is switched on using "EnableAxis".
- The axis is at standstill

2. Sequence:

The required velocity is saved as velocity profile in the SINAMICS drive. Further, the preset acceleration and deceleration values are active in the traversing profile of the axis. The "OverV" velocity override affects the preconfigured traversing velocity.

The operating conditions "CancelTraversing" and "IntermediateStop" must be set. "Jog1" and "Jog2" have no effect and must be set to "0".

The travel direction is determined via "Positive" and "Negative". Simultaneous selection is not permitted and results in a fault.

The reference point approach is started with a positive edge at "ExecuteMode".

Traversing motion is started with a positive edge at "ExecuteMode". The current state of the active command can be tracked via "EPosZSW1 / EPosZSW2" (for details on the assignment of the PosZSW, see [Appendix](#)).

Output signal "AxisRef" is set if the reference cam is appropriately found and evaluated.

If an error occurs during traversing motion, the output signal "Error" is issued.

Simplified example of a reference point approach

Fig. 5-6

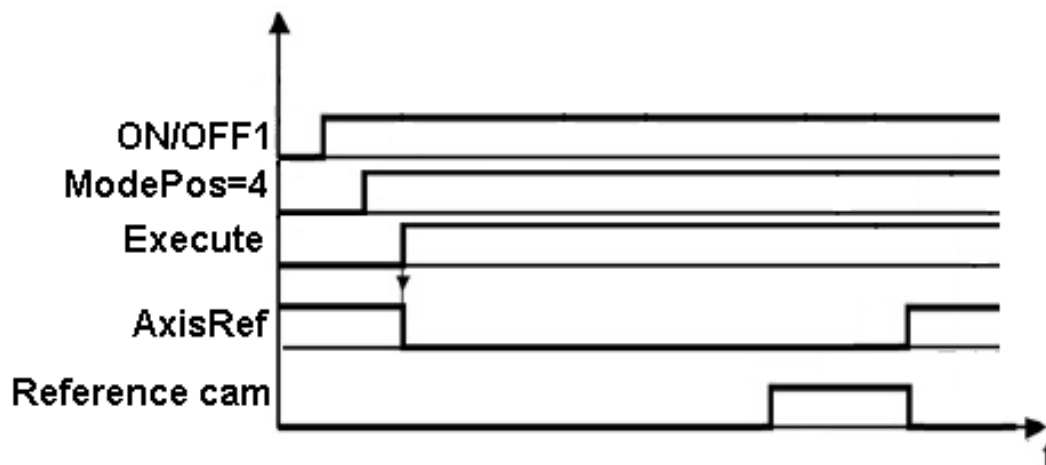

Note

A detailed graphic representation of the reference point approach can be found in the Basic Positioner Function Manual, 01/2013, FW V4.6, A5E31759509A AA, and in the SINAMICS S120 List Manual. ([4/](#))

5.2.6 Referencing – set reference point

The **Referencing – set reference point** mode enables the referencing of the axis at an arbitrary position and is performed via the "Set reference point" drive function.

1. Requirements:

- The mode is selected with "ModePos"=5.
- The axis can be in closed-loop control, but must be at a standstill.

2. Sequence:

The axis is at standstill and the reference point is set with a positive edge at "ExecuteMode".

If an error occurs while setting the reference point, the output signal "Error" is issued.

Example of set reference point

Fig. 5-7

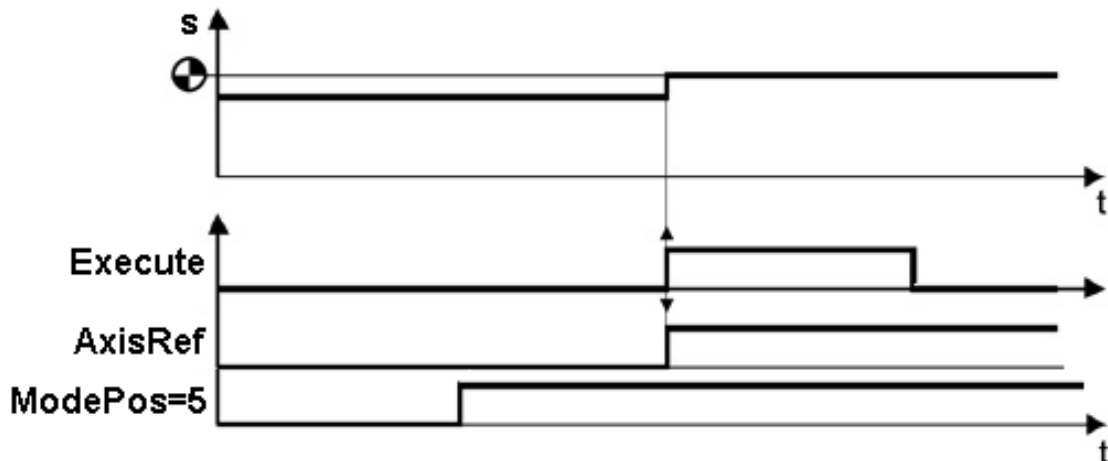

5.2.7 Traversing blocks

The **Traversing blocks** mode is implemented via the "Traversing blocks" drive function. It enables the creation of automatic programs, travel to fixed stop and outputs to be set and reset.

1. Requirements:

- The mode is selected with "ModePos"=6
- The device is switched on using "EnableAxis"
- The axis is at standstill
- The axis must be referenced or the encoder adjusted

2. Sequence:

Note The selection of the traversing task to be started is set via the "Position" input. The value must only be between 0 and 63 (S120) or 0 to 15 (G120/S110). If the value is outside these ranges, an alarm is output at the block.

The specification of the task modes, the target positions and dynamic responses is performed via the traversing block parameters in the SINAMICS drive. The velocity override "OverV" refers to the velocity setpoint stored in the traversing block.

The operating conditions "CancelTraversing" and "IntermediateStop" must be set to "1". "Jog1" and "Jog2" have no effect and should be set to "0".

The travel direction results from the task mode and the set position setpoint. The "Positive" and "Negative" are not relevant in this case and should be set to "0".

Note If a preferred direction to approach the target position is to be specified for a modulo axis, this can be set as task mode via the selection of "Positive" or "Negative".

Traversing motion is started with a positive edge at "ExecuteMode". The current state of the active command can be tracked via "EPosZSW1 / EPosZSW2" (for details on the assignment of the PosZSW, see [Appendix](#)).

The block displays the current command processing with "AxisEnabled" and acknowledges when the target position is reached successfully or the last task step completed with "AxisPosOk". If an error occurs during the traversing motion, the output signal "Error" is issued.

Example of traversing blocks

Fig. 5-8

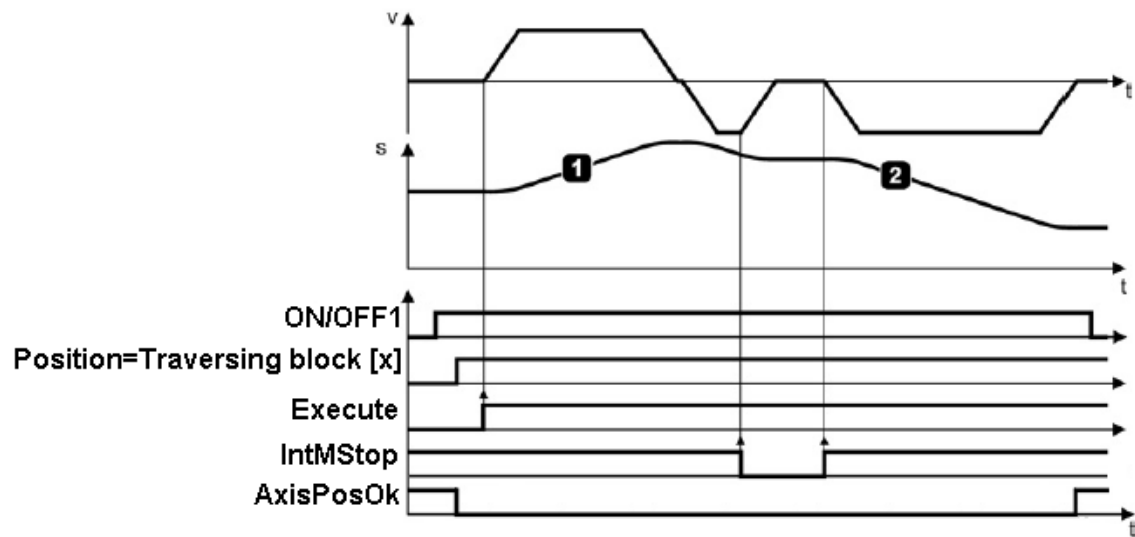

Note

The current command can be replaced on-the-fly by a new command via "ExecuteMode". This is only possible for the same operating mode.

5.2.8 Jog

The **Jog mode** is implemented using the "Jog" drive function. It enables the position-controlled, velocity-dependent traversing of axes using the integrated position controller of the SINAMICS drive.

1. Requirements:

- The mode is selected with "ModePos" = 7.
- The device is switched on using "EnableAxis"
- The axis is at standstill
- The axis must **not** be referenced or adjusted

2. Sequence:

The specification of the jog velocity is performed via the STARTER/Startdrive screen form or the acyclic communication for the configuration of the operating mode in the SINAMICS drive. The SINAMICS drive uses the acceleration and deceleration set in the SINAMICS drive for the dynamic responses of the axis.

The velocity override also applies in this operating mode and is set via "OverV".

The operating conditions "CancelTraversing" and "IntermediateStop" are not relevant for the operating mode and can be set to "1" as standard.

Note

"Jog1" and "Jog2" are the signal sources for the jog mode in EPos. The direction of the traversing motion of the respective signal source is configured in the SINAMICS drive and is set as standard to Jog1 = negative and Jog2 = positive.

The travel direction when jogging results from the set velocity setpoint.

The inputs "Positive" and "Negative" are not relevant for the operating mode and can be set to "0" as standard.

The current state of the active command can be tracked via "EPosZSW1 / EPosZSW2" (for details on the assignment of the PosZSW, see [Appendix](#)).

The block displays the current command processing with "AxisEnabled" and acknowledges the termination of the jog function ("Jog1" or "Jog2" = 0) when the axis is at standstill with "AxisPosOk". If an error occurs during the traversing motion, the output signal "Error" is issued.

Note

The current command can be replaced on-the-fly by a new command via "Jog1" or "Jog2". This is only possible when you remain in one of the jog modes.

Example of the jog mode

Fig. 5-9

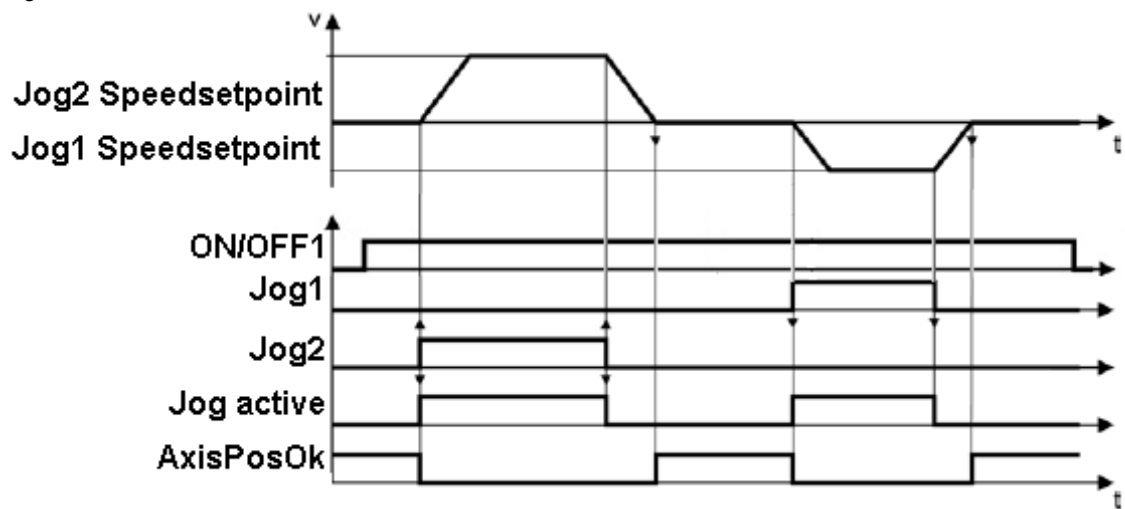

5.2.9 Incremental jogging

The **Incremental jogging** mode is implemented via the "Jog" drive function. It enables the position-controlled, distance-dependent traversing of axes using the integrated position controller of the SINAMICS drive.

1. Requirements:

- The mode is selected with "ModePos" = 8
- The device is switched on via "EnableAxis"
- The axis is at standstill
- The axis must **not** be referenced or adjusted

2. Sequence:

The distance and velocity are specified via the STARTER/Startdrive screen form or the acyclic communication for the configuration of the operating mode in the SINAMICS drive. The SINAMICS drive uses the configuration of the acceleration and deceleration in the SINAMICS drive for the dynamic responses of the axis.

The velocity override also applies in this operating mode and is set via "OverV".

The operating conditions "CancelTraversing" and "IntermediateStop" are not relevant for the operating mode and can be set to "1" as standard.

Note

"Jog1" and "Jog2" are the signal sources for the jog mode in EPos. The direction of the incremental traversing motion of the respective signal source is configured in the SINAMICS drive and for incremental jogging is set to 1000 LU (length units).

The travel direction when jogging results from the set velocity setpoint.

The inputs "Positive" and "Negative" are not relevant for the operating mode and can be set to "0" as standard.

The current state of the active command can be tracked via "EPosZSW1 / EPosZSW2" (for details on the assignment of the PosZSW, see [Appendix](#)).

The block displays the current command processing with "AxisEnabled" and acknowledges the termination of the jog function ("Jog1" or "Jog2" = 0) when the axis is at standstill with bit "AxisPosOk". If an error occurs during the traversing motion, the output signal "Error" is issued.

Note

The current command can be replaced on-the-fly by a new command via "Jog1" or "Jog2". This is only possible when you remain in one of the jog modes.

Example of incremental jogging

Fig. 5-10

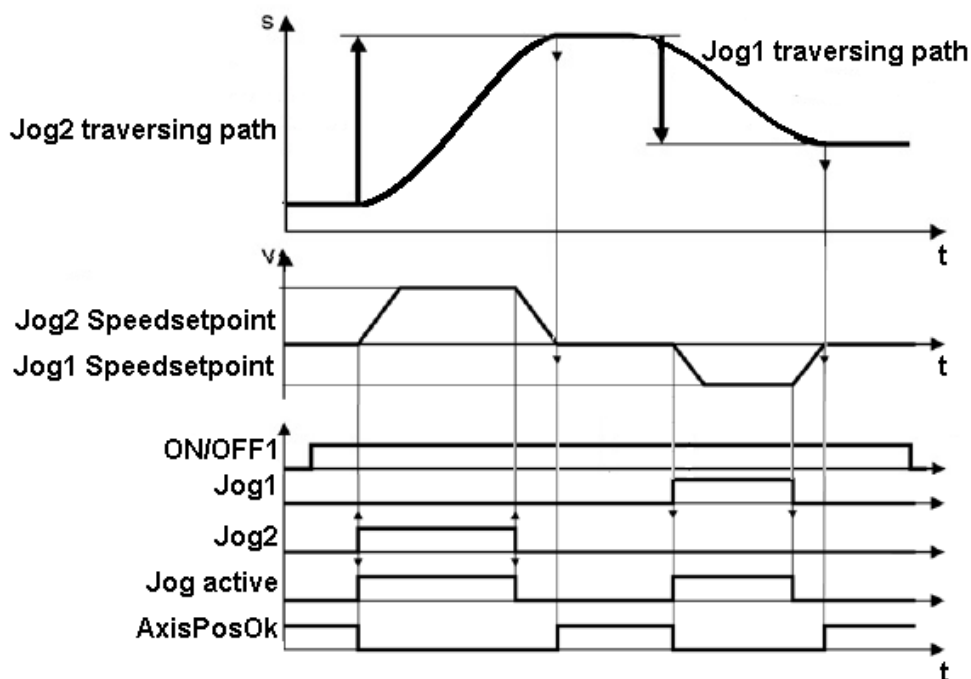
**5.2.10 Flying referencing**

The **Flying referencing (passive referencing)** mode is implemented via the "Referencing" drive function and is subordinate to most operating modes. It enables the re-referencing of the SINAMICS drive during operation.

1. Requirements:

- "FlyRef" input is set to "1"
- "ModePos" = 4 (reference point approach) and 5 (set reference point) **not** selected

2. Sequence:

The settings/requirements of the active operating mode apply. Flying referencing can be selected and deselected at any time. When the set reference probe is reached, the setpoint and actual value are processed on-the-fly.

5.2.11 Change of operating mode based on the "ModePos" values

Fig. 5-11

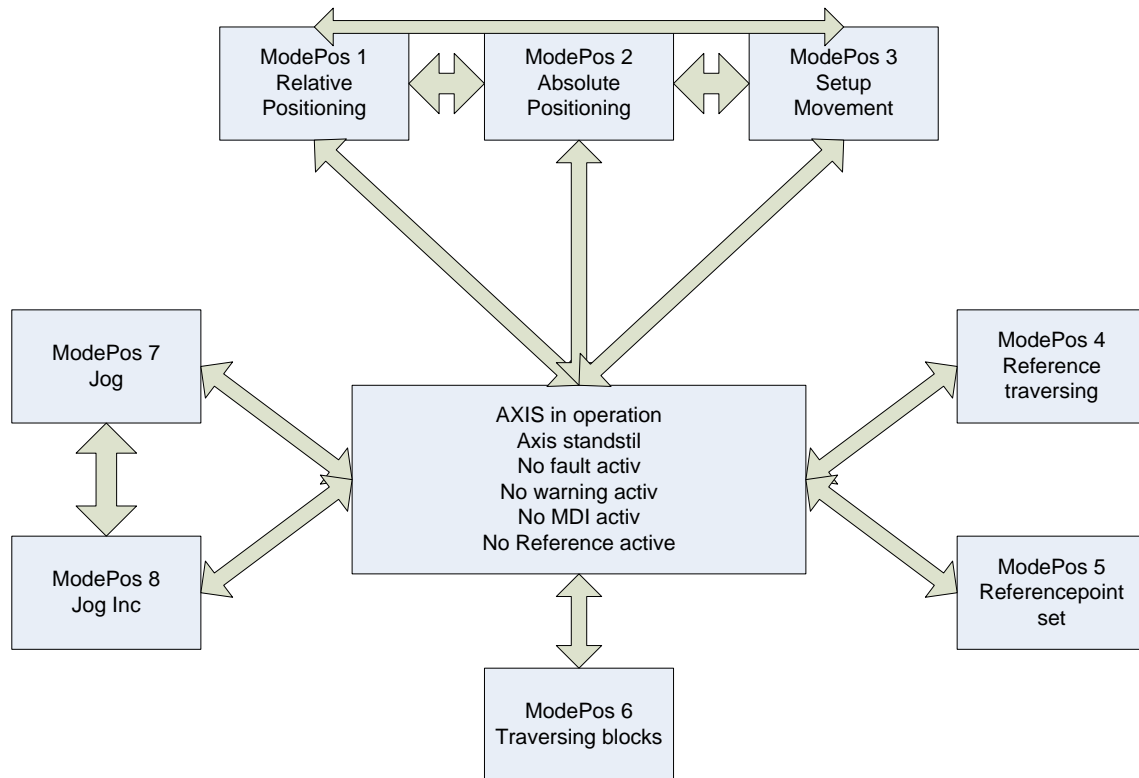

5.2.12 Troubleshooting the SINA_POS function block

When an error is detected, the "Error" group error and the "ErrorId" are set. The following errors are monitored:

Table 5-6

Error number Status	Cause	Remedy
16#7002	No error	
16#8600	Interruption of the communication to the SINAMICS drive: Error DPRD_DAT	Check the communication connections / settings (see DiagId)
16#8601	Interruption of the communication to the SINAMICS drive: Error DPWR_DAT	Check the communication connections / settings (see DiagId)
16#8202	Incorrect operating mode selected	Set "ModePos" from 1 to 8
16#8203	Incorrect parameterization of the override inputs	Check the settings of the override inputs
16#8204	Invalid traversing block number	Enter a traversing block number from 0 to 63
16#8401	Alarm message(s) in the SINAMICS drive	Evaluation of the error code at the "ActFault" output
16#8402	Switching on inhibited of the SINAMICS drive active	Check whether axis/encoder is parked, safety functions active, Parameter p10 ≠ 0
16#8403	Flying referencing could not be started	Check for pending alarms/faults in the drive,

- SINAMICS drive faults – displayed via the "ActFault" output – can be acknowledged (if possible) via the "AckError" input.
- Pending alarms do not have to be acknowledged. They are marked by the SINAMICS drive as corrected as soon as the user has resolved the cause of the alarms.

Note The meanings of the displayed faults and alarms are described in the list manual of the respective SINAMICS drive.

- The fault of the SFB call is displayed at the "DiagID" output and must be checked by the user. As soon as this fault has been resolved or has gone, the "Error" group error is reset and the "Status" output is updated.

NOTICE If error message 8092(hex) occurs at the DIAGID output, the S7-300/400/1x00 firmware must be checked. The following applies:

- S7-300 → firmware at least 2.x
- S7-1200 → firmware at least 2.x
- S7-1500 → firmware at least 1.1

6 Function block SINA_SPEED (FB285)

Fig. 6-1(S7 1200/1500 CPU)

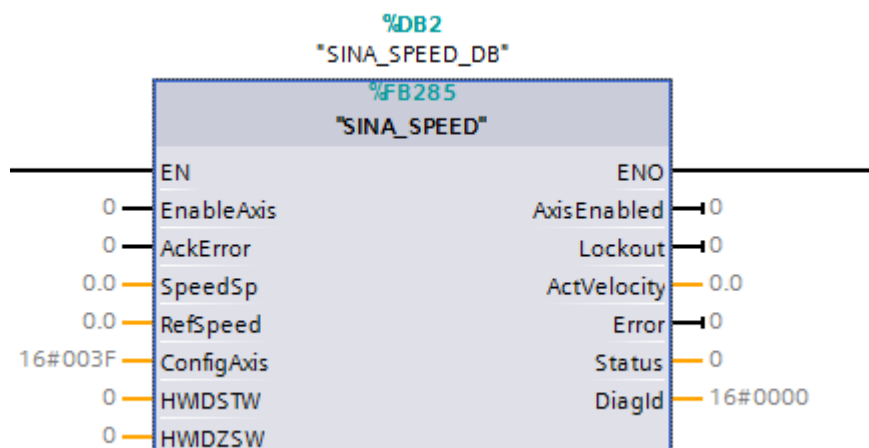
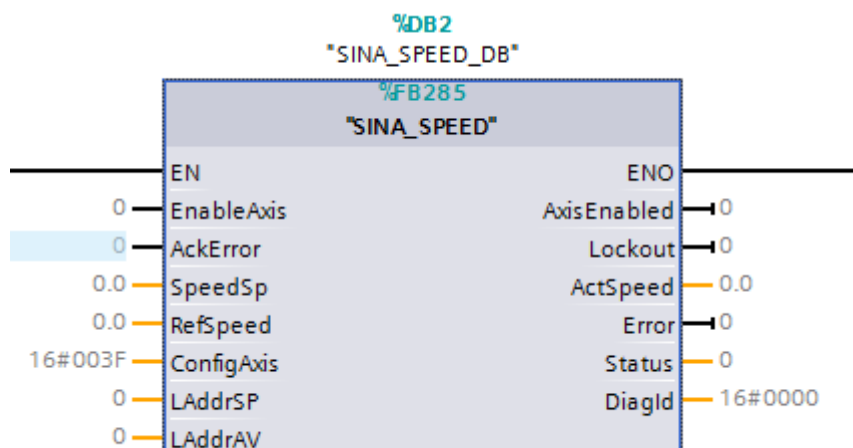

Fig. 6-2(S7 300/400 CPU)



6.1.1 Description

The appropriate instance DB is automatically created with the integration of FB285 (SINA_SPEED).

Can be used in the following CPUs: SIMATIC S7-300/400/1200/1500

6.1.2 Calling OBs

The block can be inserted alternatively in the following OBs:

- Cyclic task: OB1
- Cyclic interrupt OB: e.g. OB32

6.1.3 Called blocks

DPRD_DAT/SFC14
DPWR_DAT/SFC15

6.1.4 Function description – general

With the function block, a SINAMICS drive can be controlled cyclically with standard telegram 1.

NOTICE	Standard telegram 1 must be selected for the communication when configuring the SINAMICS drive.
---------------	--

Note	The block interface is limited to a few inputs and outputs. All telegram signals can always be accessed at any time in the setpoint direction via input "ConfigAxis". When inserting the block, the inputs are assigned default values.
-------------	---

The axis is switched on using input bit "EnableAxis" = 1. OFF2 and OFF3 are preassigned 1 using input "ConfigAxis" – and do not have to be written to for operation separately by the user.

The axis is ready to start when there is no error – "Error"= "0" – and no switching on inhibited – "Lockout" = "0".

The speed setpoint is specified directly at the "SpeedSp" block input in the REAL format. "Refspeed" – this corresponds to parameter p2000 in the SINAMICS drive – must be entered at the input in order to perform the required scaling of the setpoint. The actual speed value is output at the "ActVelocity" output in the REAL format.

6.1.5 Input interface SINA_SPEED

(Name changes from TIA V14 are marked in green)

Table 6-1

Input signal	Type	Default	Meaning
EnableAxis	BOOL	0	"EnableAxis" = 1 → switches on the drive
AckError	BOOL	0	Acknowledges axis faults → "AckFlt"=1
SpeedSp	REAL	0.0[rpm]	Speed setpoint
RefSpeed	REAL	0.0[rpm]	Rated speed of the drive → p2000
ConfigAxis	WORD	3	For more information, see Chapter 6.1.6
HWIDSTW (Block S7-1200/1500)	HW_IO	0	Symbolic name or HW ID on the SIMATIC S7-1200/1500 of the setpoint slot → see Chapter 10.3
LAddrSP (Block S7-300/400)	HW_IO	0	Symbolic name or IO address on the SIMATIC S7-300/400 of the setpoint slot → see Chapter 10.4
HWIDZSW (Block S7-1200/1500)	HW_IO	0	Symbolic name or HW ID on the SIMATIC S7-1200/1500 of the actual value slot → see Chapter 10.3
LAddrAV (Block S7-300/400)	HW_IO	0	Symbolic name or IO address on the SIMATIC S7-300/400 of the actual value slot → see Chapter 10.4

6.1.6 Default setting of the ConfigAxis input

Table 6-2

ConfigAxis	Meaning	PZD	Interconnection in the drive	Default
Bit0	OFF2	1	r2090.1 = p 844[0]	1
Bit1	OFF3	1	r2090.2 = p 848[0]	1
Bit2	Inverter enable	1	r2090.3 = p 852[0]	1
Bit3	Enable ramp-function generator	1	r2090.4 = p1140[0]	1
Bit4	Continue ramp-function generator	1	r2090.5 = p1141[0]	1
Bit5	Enable speed setpoint	1	r2090.6 = p1142[0]	1
Bit6	Direction of rotation	1	r2090.11 = p1113[0]	0
Bit7	Unconditionally open holding brake	1	r2090.12 = p855[0]	0
Bit8	Motorized potentiometer increase setpoint	1	r2090.13 = p1035[0]	0
Bit9	Motorized potentiometer, decrease setpoint	1	r2090.14 = p1036[0]	0
Bit10	Reserve – can be used as required below (bit 8)	1	r2090.8	0
Bit11	Reserve – can be used as required below (bit 9)	1	r2090.9	0
Bit12	Reserve – can be used as required below (bit 15)	1	r2090.15	0
Bit13				0
Bit14				0
Bit15				0

6.1.7 Output interface SINA_SPEED

Table 6-3

Output signal	Type	Default	Meaning
AxisEnabled	BOOL	0	Mode is being executed or enabled
Lockout	BOOL	0	1 = switching-on inhibited active
ActVelocity	REAL	0.0[rpm]	Actual velocity → dependent on scaling factor RefSpeed
Error	BOOL	0	1 = group fault active
Status	INT	0	16#7002: No error – block is being processed 16#8401: Fault in the drive 16#8402: Switching-on inhibit 16#8600: Error DPRD_DAT 16#8601: Error DPWR_DAT
DiagID	WORD	0	Extended communication error → error during SFB call

Note The complete status data of telegram 1 can be found in the [Appendix](#).

6.1.8 Comparison of the interfaces of SINA_SPEED old (<V14) and new (≥V14)

Comparison of the input interface

Table 6-4

SINA_SPEED "OLD"	Position "OLD" → "NEW"	SINA_SPEED "NEW"	Comment SINA_SPEED "NEW"
Execute	1 → 1	EnableAxis	New position of the output; Input renamed; function remains the same
Velocity	2 → 3	AckError	New position of the output; Input renamed; function remains the same
FactRPM	3 → 4	SpeedSp	New position of the output; Input renamed; function remains the same
AckFlt	4 → 2	RefSpeed	New position of the output; Input renamed; function remains the same
LaddrSP	5 → 6	ConfigAxis	New input to control the drive functions not directly specified at the block See Chapter 6.1.6
LaddrAV	6 → 7	HWDSTW	New position of the output; input renamed; function remains the same
		HWDZSW	New position of the output; input renamed; function remains the same

Comparison of the input interface

Table 6-5

SINA_SPEED "OLD"	Position "OLD" → "NEW"	SINA_SPEED "NEW"	Comment SINA_SPEED "NEW"
Error	1 → 5	AxisEnabled	New position of the output; Input renamed; function remains the same
ErrorId	2 → 6		New position
PwrInhibit	3 → 3	Lockout	Input renamed; function remains the same
Busy	4 → 1	ActVelocity	New position of the output; Input renamed; function remains the same
VeloAct	5 → 4	Error	New position of the output; Function remains the same
DiagId	6 → 7	Status	Output renamed; Error values selected in the new PLC styleguide format; see Chapter 6.1.7
		DiagID	New position of the output; function remains the same

6.1.9 Troubleshooting the SINA_SPEED function block

The "Error" group error is set when the SINAMICS drive is faulted, the switching on inhibited of the SINAMICS drive is active or when the call of the SFB returns an error. An appropriate "Status" is also output:

Table 6-6

Error number Status	Meaning	Remedy
16#7002	No fault active	
16#8401	Drive fault active	Evaluate active faults of the SINAMICS via the acyclic communication
16#8402	Drive switching on inhibited active	Check whether axis is parked, safety active, parameter p10 ≠ 0
16#8600 16#8601	Error of the SFB call active	Correction of the communication fault

- The faults of the SINAMICS drive can be acknowledged via the "AcktError" input.
- The fault of the SFB call is displayed at the "DiagID" output and must be checked by the user. As soon as this fault has been resolved or has gone, the "Error" group error is reset and the "Status" ID is updated.

NOTICE	<p>If error message 8092(hex) occurs at the DIAGID output, the S7-300/400/1x00 firmware must be checked. The following applies:</p> <ul style="list-style-type: none"> • S7-300 → firmware at least 2.x • S7-1200 → firmware at least 2.x • S7-1500 → firmware at least 1.1
---------------	--

7 Function block SINA_PARA (FB286)

Fig.7-1(S7 1200/1500 CPU)

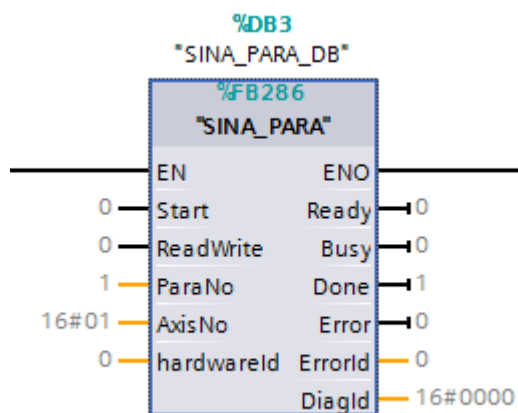
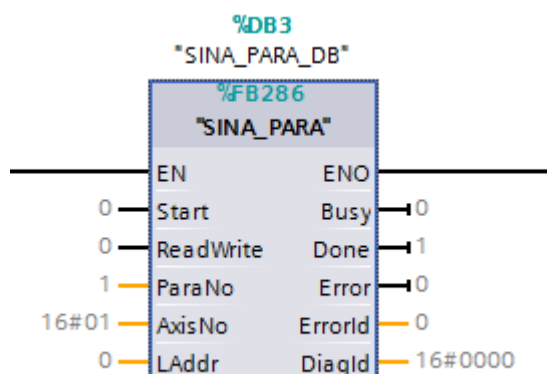

Fig.7-2(S7 300/400 CPU)



Description

The appropriate instance DB is automatically created with the integration of FB286 (SINA_PARA).

Can be used in the following CPUs: S7-300/400/1200/1500

Calling OBs

The block can be inserted alternatively in the following OBs:

- Cyclic task: OB1
- Cyclic interrupt OB: e.g. OB32

Called blocks

RDREC/SFB52

WRRECSFB53

Function description

With the function block, up to 16 parameters can be written or read acyclically on the SINAMICS S/G drive.

Note Data is accessed using data block 47 according to the PROFIdrive profile.

Whether the number of parameters specified at the "ParaNo" input are to be written to the SINAMICS drive or read from the SINAMICS drive is specified at the "ReadWrite" input.

Reading or writing parameters is started by the edge-triggered "Start" input.

Parameter data is stored in a preconfigured, internal structure of the created "sxParameter" instance data block. The complete instance data block can be freely accessed and changed.

The data to be written or read is entered or displayed in the REAL or DINT format.

NOTICE	ONLY the "sxParameter" area must be adapted by the user, or evaluated in the case of a transfer error. All other areas of the instance data block are required for internal measures – and it is NOT permissible that they are changed.
---------------	--

7.1.1 Input interface of SINA_PARA

(Name changes from TIA V14 are marked in green)

Table 7-1

Input signal	Type	Default	Meaning
Start	BOOL	0	Start of the job (0 = no job or cancel the actual job; 1= start job and perform the job)
ReadWrite	BOOL	0	Type of job 0=read, 1=write
ParaNo	INT	1	Number of parameters → 1 to 16
AxisNo	INT	1	Axis number / axis ID for multi-axis system
hardwareId (Block S7-1200/1500)	HW IO	0	Hardware ID of the access points module/actual value telegram slot of the axis or drive → see Chapter 10.3
Laddr (Block S7-300/400)	HW IO	0	Diagnostics address of the axis or drive → see Chapter 10.4

7.1.2 Output interface of SINA_PARA

Table 7-2

Output signal	Type	Default	Meaning
Ready (Block S7-1200/1500)	BOOL	0	Feedback signal to integrate in the LAcycCom environment; 1 = job completed or job interrupted (for one cycle) See Chapter 7.2

Output signal	Type	Default	Meaning
Busy	BOOL	0	"Busy"=1 indicates that the job is being processed
Done	BOOL	0	Edge change from 0→1 indicates that the job has been completed
Error	BOOL	0	Group error active → "Error" =1
ErrorId	DWORD	0	1st word → which parameter access is faulted in binary code 2nd word: Fault type
DiagId	WORD	0	Extended communication error → error during SFB call

7.1.3 Data structure of the "sxParameter" area

Job fields to be filled in by the user:

- **sxParameter[x].siParaNo** := parameter number (value range 1..65535)
- **sxParameter[x1].siIndex** := parameter index (value range 0..65535)
- **sxParameter[x].srValue** := parameter value (value range $\pm 1.175\,495e-38.. \pm 3.402823e+38$) – when reading is filled by the block
- **sxParameter[x].sdValue** := parameter value (value range -214748364810 (-2^{31}) to +214748364710 (2^{31}))

Fig. 7-3

44	▾ sxParameter	Array [1..16] of Struct		<input type="checkbox"/>	<input checked="" type="checkbox"/>	<input checked="" type="checkbox"/>	<input type="checkbox"/>	
45	▾ sxParameter[1]	Struct		<input type="checkbox"/>	<input checked="" type="checkbox"/>	<input checked="" type="checkbox"/>	<input type="checkbox"/>	
46	▾ siParaNo	Int	0	<input type="checkbox"/>	<input checked="" type="checkbox"/>	<input checked="" type="checkbox"/>	<input type="checkbox"/>	Number of parameter (Number 1..65535)
47	▾ siIndex	Int	0	<input type="checkbox"/>	<input checked="" type="checkbox"/>	<input checked="" type="checkbox"/>	<input type="checkbox"/>	Subindex (Number 1..65535)
48	▾ srValue	Real	0.0	<input type="checkbox"/>	<input checked="" type="checkbox"/>	<input checked="" type="checkbox"/>	<input type="checkbox"/>	Value of parameter
49	▾ sdValue	DInt	0	<input type="checkbox"/>	<input checked="" type="checkbox"/>	<input checked="" type="checkbox"/>	<input type="checkbox"/>	Value of parameter
50	▾ syFormat	Byte	B#16#00	<input type="checkbox"/>	<input checked="" type="checkbox"/>	<input checked="" type="checkbox"/>	<input type="checkbox"/>	Format of value (Format 0x40..0x44)
51	▾ swErrorNo	Word	W#16#0000	<input type="checkbox"/>	<input checked="" type="checkbox"/>	<input checked="" type="checkbox"/>	<input type="checkbox"/>	Error number (see table below)

NOTICE From TIA Portal / Startdrive V14 and higher, the instance data block of SINA_PARA contains two different inputs and/or output fields in the REAL and DINT formats in the data structure "sxParameter" (new!).

From this version, all parameters, type DWORD or DINT must be written from this version to field sxParameter[x].sdValue. This block logic has been changed in so much that when automatically identifying the DWORD / DINT formats, the job field sxParameter[x].sdValue is used for writing and/or reading.

For all other parameters, just as before, the already existing sxParameter[x].srValue field is used.

NOTICE Contrary to older versions, starting with this version V4.x, the user must know whether the format of the parameter to be read/written to involves DWORD / DINT or reset (byte, word, real, INT, ...).

If this is not taken into consideration, when writing, it is possible that problems occur, as in this case, the default value of the DINT field ("0") is transferred instead of the required value (which was incorrectly entered into the REAL field).

Further, for parameters in the DWORD / DINT format, read operations must be evaluated using the new job field.

Note When using symbolic programming, the parameter structure is also compatible to older programs of the TIA Portal, versions V12SP1 or V13SPx.

Note Using the new job field, it is now possible to read/write BICO parameters without any problem.

The various formats of the parameter are determined by the block itself. (Value range 0x40 = zero, 0x41/0x02/0x05 = byte, 0x42/0x03/0x06 = word, 0x43/0x04/0x07/0x08 = Dword, 0x44 = error)

The following job fields are filled by the block:

- `sxParameter[x].syFormat` := parameter format
- `sxParameter[x].swErrorNo` := parameter error number (value range 0x0000..0x00FF)

Fig. 7-4 Diagram showing the optimized instance data block (S7-1x00)

Field	Type	Value	Bit 0	Bit 1	Bit 2	Bit 3	Bit 4	Bit 5	Bit 6	Bit 7	Bit 8	Bit 9	Bit 10	Bit 11	Bit 12	Bit 13	Bit 14	Bit 15
sxParameter	Array[1..16]																	
sxParameter[1]	Struct																	
siParaNo	Int	0																Number of parameter (Number 1..65535)
siIndex	Int	0																Subindex (Number 1..65535)
srValue	Real	0.0																Value of parameter
sdValue	Dint	0																Value of parameter
syFormat	Byte	B#16#00																Format of value (Format 0x40..0x44)
swErrorNo	Word	W#16#0000																Error number (see table below)
sxParameter[2]	Struct																	
sxParameter[3]	Struct																	
sxParameter[4]	Struct																	
sxParameter[5]	Struct																	
sxParameter[6]	Struct																	
sxParameter[7]	Struct																	
sxParameter[8]	Struct																	
sxParameter[9]	Struct																	
sxParameter[10]	Struct																	
sxParameter[11]	Struct																	
sxParameter[12]	Struct																	
sxParameter[13]	Struct																	
sxParameter[14]	Struct																	
sxParameter[15]	Struct																	
sxParameter[16]	Struct																	

7.1.4 Writing to parameters

The "Write" action first reads the parameter value and the format of the set parameter from the SINAMICS drive and writes them to the parameter structure. After successful reading, the parameter value of the appropriate job field set by the user is then transferred to the SINAMICS drive.

While this is being performed, the "Busy" bit is set to "1".

If the parameter to be written is faulty, the associated parameter error numbers are read out and entered in the structure. At the same time, the appropriate error bit is set in the first word of the "ErrorID" double word.

A successful write action is terminated with the edge change "1→0" of the "Busy" bit and the edge change "0→1" of the "Done" bit. It is NOT permissible that the "Error" bit is set. If this happens, the "ErrorID" double word must be evaluated.

7.1.5 Reading parameters

The "Read" action reads the parameter value and the format of the set parameter from the SINAMICS drive and writes them to the parameter structure. The value of the appropriate job field to be read is then stored in the structure.

While this is being performed, the "Busy" bit is set to "1".

If the parameter to be read is incorrect, the associated parameter error numbers are read out and entered in the structure. At the same time, the appropriate error bit is set in the first word of the "ErrorID" double word.

A successful read action is terminated with the edge change "1→0" of the "Busy" bit and the edge change "0→1" of the "Done" bit. It is NOT permissible that the "Error" bit is set. If this happens, the "ErrorID" double word must be evaluated.

7.1.6 Troubleshooting function block SINA_PARA

The Profidrive errors that occur temporarily during communication with the SINAMICS drive are determined and the action to be executed is repeated.

NOTICE

The parameters siErrorCount (actual count status) and siMaxErrCount are listed in the instance data block. The siMaxErrCount can be edited by the user and specifies the maximum number of times the job can be repeated when temporary errors occur (default 12500). Error = 1 is then set and the ErrorID set.

- During an active SFB error, group error "Error = 1" is set, and an output is made in the first word of ErrorID as well as output DiagID. The faults caused by the SFB calls do not have to be acknowledged. As soon as these faults have been resolved, and a new job started, then outputs DiagID, Error and ErrorID are withdrawn.
- If an incorrect value is entered at the "ParaNo" input, this value is not considered and the group error is set and the parameterization error displayed in the "ErrorID" output.
- Further, group error "Error" is set if a "Request" error occurs. For these errors, the job is executed, however, several parameters were not able to be accessed. The errors caused by the access are displayed in binary code in the second word of the "ErrorID" double word. The job is also displayed as having been completed with "Done" = 1.

Evaluating the ErrorID output

Table 7-3

ErrorID	
ErrorID[1]	ErrorID[2]

ErrorID[1]	Meaning
0x000	No fault active
0x001	Internal telegram error active
0x002	Parameterization error active
0x003	Error active when calling SFB
0x004	Job canceled during data transfer by resetting the start input to "0"
0x005	Unknown data type identified; evaluation of ErrorID[2] indicates the parameter with the unknown data type in the most significant bit

ErrorID[2]	Meaning
0x00	No error during parameter access
0x01	1st parameter access error Evaluation, see swParameter[1].ErrorNo
0x02	2nd parameter access error Evaluation, see swParameter[2].ErrorNo
0x04	3rd parameter access error Evaluation, see swParameter[3].ErrorNo
0x08	4th parameter access error Evaluation, see swParameter[4].ErrorNo
0x10	5th parameter access error Evaluation, see swParameter[5].ErrorNo
0x20	6th parameter access error Evaluation, see swParameter[6].ErrorNo
0x40	7th parameter access error Evaluation, see swParameter[7].ErrorNo
0x80	8th parameter access error Evaluation, see swParameter[8].ErrorNo
0x100	9th parameter access error Evaluation, see swParameter[9].ErrorNo
0x200	10th parameter access error Evaluation, see swParameter[10].ErrorNo
0x400	11th parameter access error Evaluation, see swParameter[11].ErrorNo
0x800	12th parameter access error Evaluation, see swParameter[12].ErrorNo
0x1000	13th parameter access error Evaluation, see swParameter[13].ErrorNo
0x2000	14th parameter access error Evaluation, see swParameter[14].ErrorNo
0x4000	15th parameter access error Evaluation, see swParameter[15].ErrorNo
0x8000	16th parameter access error Evaluation, see swParameter[16].ErrorNo

7.2 Connection to the LAcycCom library

Note LAcycCom libraries for SIMATIC S7-1200/S7-1500 facilitate collision-free coordination of communication resources in the CPU for acyclic communication using DPV1 services. For this purpose, in the application, instead of the system functions, the corresponding functions in these libraries are used to communicate with external devices.

Note The LAcycCom library can be accessed at the following SIOS link:

<https://support.industry.siemens.com/cs/ww/de/view/109479553>

Note For use within the LAcycCom environment, function block "LAcycCom_ResourceManager", global data block "LAcycCom_RequestBuffer" and the PLC variables and PLC data types available in the libraries are required.

Fig. 7-5

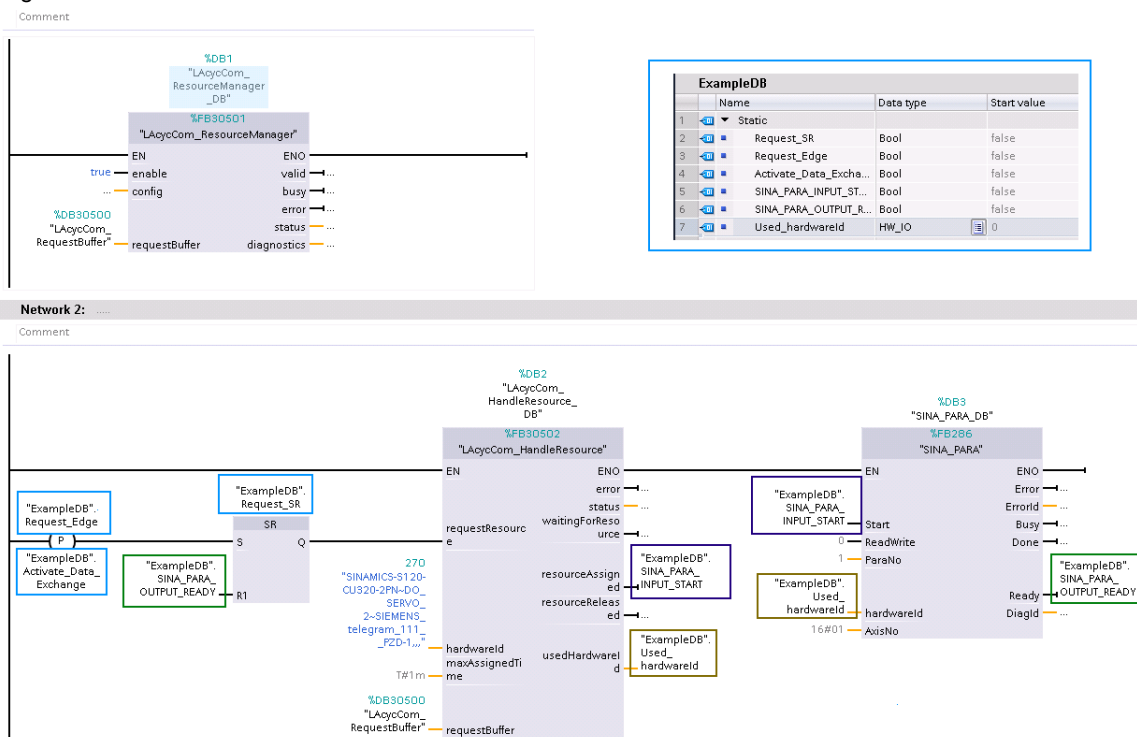

Blocks SINA_PARA and SINA_PARA_S are connected in conjunction with the "LAcycCom_HandleResource" block.

The acyclic communication job is transferred to the HandleResource block, and after the release (by the ResourceManager) this controls block SINA_PARA.

After the job has been completed, block SINA_PARA communicates this to the HandleResource block via the Ready output (for one cycle). This can now release the resource again.

To reliably evaluate the start and enable signals, an edge evaluation is used for the start command as well as a memory element (SR flip flop).

Note

Block SINA_PARA_S is connected in the same way.

8 Function block SINA_PARA_S (FB287)

Fig. 8-1(S7 1200/1500 CPU)

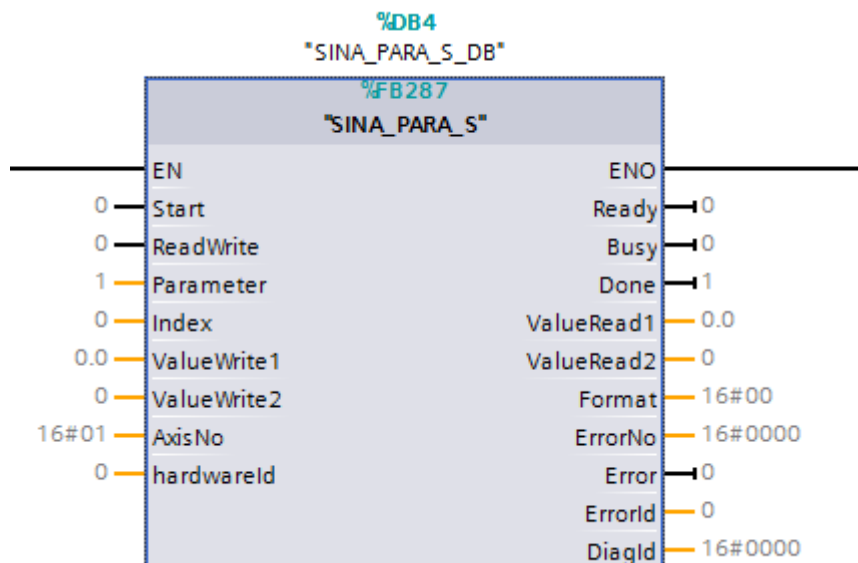
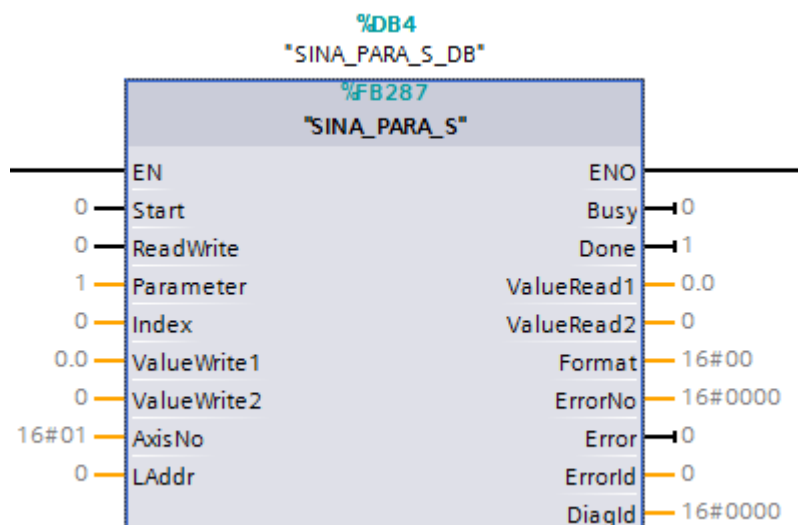

Fig. 8-2(S7 300/400 CPU)



Description

The appropriate instance DB is automatically created with the integration of SINA_PARA_S (FB287).

Can be used in the following CPUs: S7-300/400/1200/1500

Calling OBs

The block can be inserted alternatively in the following OBs:

- Cyclic task: OB1
- Cyclic interrupt OB: e.g. OB32

Called blocks

RDREC/SFB52

WRRECSFB53

Function description

With the function block, 1 parameter can be written or read acyclically to the SINAMICS S/G drive.

Note Data is accessed using data block 47 according to the PROFIdrive profile.

Whether the parameter is to be written to the SINAMICS drive or read from the SINAMICS drive is specified at the "ReadWrite" input.

Reading or writing parameters is started by the edge-triggered "Start" input.

8.1.1 Input interface of SINA_PARA_S

Table 8-1

Input signal	Type	Default	Meaning
Start	BOOL	0	Start of the job (0 = no job or cancel the actual job; 1= start job and perform the job)
ReadWrite	BOOL	0	Type of job 0=read, 1=write
Parameter	INT	1	Parameter number
Index	INT	0	Index of the parameter
ValueWrite1	REAL	0.0	Parameter value in the REAL format
ValueWrite2	DINT	0	Parameter value in the DINT format
AxisNo	INT	1	Axis number / axis ID for multi-axis system
hardwareId (Block S7-1200/1500)	HW IO	0	Hardware ID of the access points module/actual value telegram slot of the axis or drive → see Chapter 10.3
Laddr (Block S7-300/400)	HW IO	0	Diagnostics address of the axis or drive → see Chapter 10.4

8.1.2 Output interface of the FB287

Table 8-2

Output signal	Type	Default	Meaning
Ready (Block S7-1200/1500)	BOOL	0	Feedback signal to integrate in the LAcycCom environment; 1 = job completed or job interrupted (for one cycle) See Chapter 7.2
Busy	BOOL	0	"Busy"=1 indicates that the job is being processed
Done	BOOL	0	Job completed without error means edge change from 0→1
ValueRead1	REAL	0.0	Value of read parameter (REAL format)

Output signal	Type	Default	Meaning
ValueRead2	DINT	0	Value of read parameter (DINT format)
Format	INT	0	Format of read parameter
ErrorNo	INT	0	Error number acc. to PROFIdrive profile
Error	BOOL	0	Group error active → "Error" =1
ErrorId	DWORD	0	1st word → which parameter access is faulted in binary code 2nd word: Fault type
DiagId	WORD	0	Extended communication error → error during SFB call

8.1.3 Using the various parameter inputs and outputs

NOTICE	<p>From TIA Portal / Startdrive V14 and higher, the input area of SINA_PARA_S contains two different inputs and/or outputs in the REAL and DINT formats (new!).</p> <p>From this version, all parameters, type DWORD or DINT must be written from this version to field ValueWrite2. This block logic has been changed in so much that when automatically identifying the DWORD / DINT formats, the job field ValueWrite2 is used for writing or ValueRead2 for reading.</p> <p>For all other parameters, just as before, the already existing ValueWrite1 or ValueRead1 field is used.</p>
---------------	---

NOTICE	<p>Contrary to older versions, starting with this version V4.x, the user must know whether the format of the parameter to be read/written to involves DWORD / DINT or reset (byte, word, real, INT, ...).</p> <p>If this is not taken into consideration, when writing, it is possible that problems occur, as this case, the default value of the DINT field ("0") is transferred instead of the required value (which was incorrectly entered into the REAL field).</p> <p>Further, for parameters in the DWORD / DINT format, read operations must be evaluated using the new job field.</p>
---------------	---

Note	<p>When using symbolic programming, the parameter structure is also compatible to older programs of the TIA Portal, versions V12SP1 or V13SPx.</p> <p>Using the new job field, it is now possible to read/write BICO parameters without any problem.</p>
-------------	--

8.1.4 Writing to parameters

The "Write" action initially means that the parameter value at input ValueWrite1 and ValueWrite2 is accepted. After the parameter format has been successfully read, the appropriate job field is transferred to the SINAMICS drive.

While this is being performed, the "Busy" bit is set to "1".

If the parameter to be written is incorrect, the associated parameter error numbers are read out and entered at the ErrorNo output. At the same time, the appropriate error bit is set in the first word of the "ErrorID" double word.

A successful write action is terminated with the edge change "1→0" of the "Busy" bit and the edge change "0→1" of the "Done" bit. It is NOT permissible that the "Error" bit is set. If this happens, the "ErrorID" double word must be evaluated.

8.1.5 Reading parameters

The "Read" action initially means that the parameter at the input parameter is read, and the drive displays the appropriate value at the ValueRead1 or Value Read2 output.

While this is being performed, the "Busy" bit is set to "1".

If the parameter to be read has an error, the associated parameter error numbers are output. At the same time, the appropriate error bit is set in the first word of the "ErrorID" double word.

A successful read action is terminated with the edge change "1→0" of the "Busy" bit and the edge change "0→1" of the "Done" bit. It is NOT permissible that the "Error" bit is set. If this happens, the "ErrorID" double word must be evaluated.

8.1.6 Troubleshooting function block SINA_PARA_S

The errors that occur temporarily during the communication with the SINAMICS drive are determined and the action to be executed is repeated.

NOTICE

The parameters siErrorCount (actual count status) and siMaxErrCount are listed in the instance data block. The siMaxErrCount can be edited by the user and specifies the maximum number of times the job can be repeated when temporary errors occur (default 12500).
Error = 1 is then set and the ErrorID set.

- During an active SFB error, group error "Error = 1" is set, and an output is made in the first word of ErrorID as well as output DiagID. The faults caused by the SFB calls do not have to be acknowledged. As soon as these faults have been resolved, and a new job started, then outputs DiagID, Error and ErrorID are withdrawn.
- If an incorrect value is entered at the "ParaNo" input, this value is not considered and the group error is set and the parameterization error displayed in the "ErrorID" output.
- Further, group error "Error" is set if a "Request" error occurs. For these errors, the job is executed, however, several parameters were not able to be accessed. The errors caused by the access are displayed in binary code in the second word of the "ErrorID" double word. The job is also displayed as having been completed with "Done" = 1.

Evaluating the ErrorID output

Table 8-3

ErrorID	
ErrorID[1]	ErrorID[2]

ErrorID[1]	Meaning
0x000	No fault active
0x001	Internal telegram error active
0x002	Parameterization error active
0x003	Error active when calling SFB
0x004	Job canceled during data transfer by resetting the start input to "0"
0x005	Unknown data type identified; evaluation of ErrorID[2] indicates the parameter with the unknown data type in the most significant bit

ErrorID[2]	Meaning
0x00	No error during parameter access
0x01	1st parameter access error Evaluation, see swParameter[1].ErrorNo

9 Function block SINA_INFEED (FB288)

Fig. 9-1(S7 1200/1500 CPU)

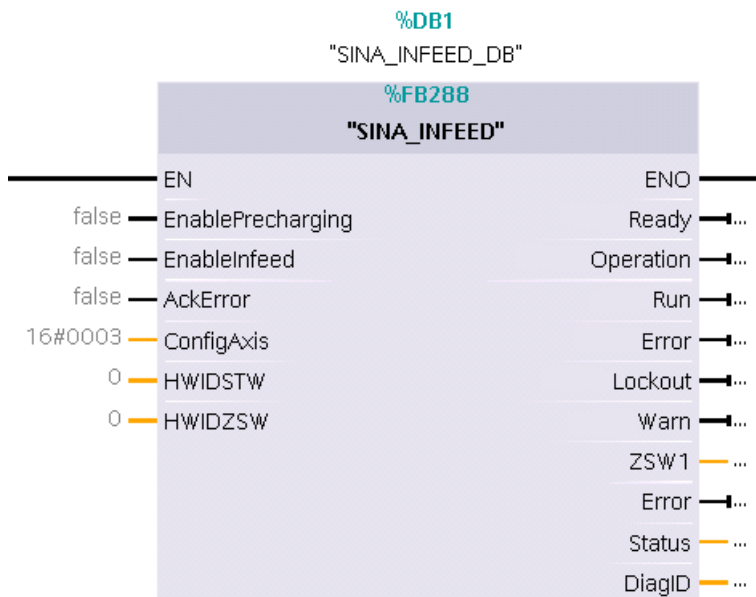

Description

The block is employed to use a SINAMICS S120 infeed unit. The block only uses control word STW1, and evaluates status word ZSW1 of the infeed unit (standard telegram 370).

The appropriate instance DB is automatically created with the integration of SINA_INFEED (FB288).

Can be used in the following CPUs: S7-1200/1500

Calling OBs

The block can be inserted alternatively in the following OBs:

- Cyclic task: OB1
- Cyclic interrupt OB: e.g. OB32

Called blocks/instructions

DPRD_DAT	Read consistent data of a standard DP slave
DPWD_DAT	Write consistent data of a standard DP slave

9.1.1 Function description

The hardware ID of the setpoint slot is specified using input "HWIDSTW" – and the actual value slot is specified using input "HWIDZSW".

By setting input "EnablePrecharging" (STW1.0), the infeed unit can be precharged and using input "EnableInfeed" (STW1.3) it can be switched on (by setting the corresponding control bit in STW1).

The functions are only executed if the infeed unit is in the necessary state (evaluation of the actual ZSW1).

The individual feedback signals (relevant status bits) of the infeed unit and complete status word 1 are output via the block outputs.

In addition to inputs "EnablePrecharging", "EnableInfeed" and "AckError", the user can make additional entries in control word 1 using parameter "ConfigAxis" (standard: 3h). For immediate operation, certain bits in the telegram are preassigned using this input.

Bit "Control request" (STW1.10) is cyclically set within the block.

9.1.2 Input interface of SINA_INFEED

Table 9-1

Input signal	Type	Default	Meaning
EN	BOOL	1	
EnablePrecharging	BOOL	0	Precharge infeed unit
EnableInfeed	BOOL	0	Switch on infeed unit
AckError	BOOL	0	Acknowledge infeed unit fault
ConfigAxis	WORD	16#0003	For more information, see Chapter 9.1.3
HWIDSTW	HW_IO	0	Symbolic name or HW ID on the SIMATIC S7-1200/1500 of the setpoint slot (SetPoint) → see Chapter 10.3
HWIDZSW	HW_IO	0	Symbolic name or HW ID on the SIMATIC S7-1200/1500 of the actual value slot (Actual Value) → see Chapter 10.3

9.1.3 Default setting of the ConfigAxis input

ConfigAxis

Table 9-2

ConfigAxis	Meaning	PZD	Interconnection in the drive	Default
Bit0	OFF2	1	r2090.1 = p 844[0]	1
Bit1	Inverter enable	1	r2090.3 = p 852[0]	1
Bit2	1 = inhibit motoring operation	1	r2090.5 = p 3532	0
Bit3	1 = inhibit generator operation	1	r2090.6 = p 3533	0
Bit4	Reserve – can be used as required below (bit 2)	1	r2090.2	0
Bit5	Reserve – can be used as required below (bit 4)	1	r2090.4	0
Bit6	Reserve – can be used as required below (bit 8)	1	r2090.8	0
Bit7	Reserve – can be used as required below (bit 9)	1	r2090.9	0
Bit8	Reserve – can be used as required below (bit 11)	1	r2090.11	0
Bit9	Reserve – can be used as required below (bit 12)	1	r2090.12	0
Bit10	Reserve – can be used as required below (bit 13)	1	r2091.13	0
Bit11	Reserve – can be used as required below (bit 14)	1	r2091.14	0
Bit12	Reserve – can be used as required below (bit 15)	1	r2091.5	0
Bit13				0
Bit14				0
Bit15				0

9.1.4 Output interface of SINA_INFEED

Table 9-3

Output signal	Type	Default	Meaning
ENO	BOOL	1	
Ready	BOOL	1	Ready for switch on (ZSW1.0)
Operation	BOOL	0	Ready to operate (ZSW1.1)
Run	BOOL	0	Infeed In operation (ZSW1.2)
Error	BOOL	0	Infeed unit fault (ZSW1.3)
Lockout	BOOL	0	Infeed Inhibited (ZSW1.6)
Warning	BOOL	0	Infeed unit alarm (ZSW1.7)
STW1	WORD	16#0	Status word 1
Error	BOOL	0	Error
DiagID	WORD	0	Extended communication error RET_VAL from system functions DPRD_DAT or DPWR_DAT (also see parameter "Status")
Status	WORD	16#0	16#7002: No error active 16#7200: Infeed unit alarm 16#8400: Precharging fault 16#8401: Infeed unit fault 16#8600: Error: DPRD_DAT 16#8601: Error: DPWR_DAT

9.1.5 Troubleshooting function block SINA_INFEED

The "Error" output signals a general error, which can be specified in more detail using the "Status" output.

If inputs "EnablePrecharging" and "EnableInfeed" are set, and the drive signals a fault/error, then the control bits for precharging and switching-on are reset.

If input "EnableInfeed" is set and "EnablePrecharging" is not set, then output "Error" = 1 – and status is set = 16#8400. If input "EnablePrecharging" is again set to 1, then output "Error" is immediately set to 0 again (acknowledgment is not required).

Communication between the SIMATIC CPU and the infeed unit is realized via system blocks "DPRD_DAT" and "DPWR_DAT".

If, while the system blocks are being executed, an error occurs, then output "Error" is set to 1, and the error message of the system function is output via output "DiagID".

Depending on which system function signals the error, then the "Status" output is set to 16#8600 (DPRD_DAT) or to 16#8601 (DPWR_DAT).

If, for the two system functions, an error is active, then the error message of block DPRD_DAT is first output, and when this is no longer active, then that of DPWR_DAT, assuming that this is still active.

An infeed unit fault is displayed using output "Fault" = 1 and "Status" = 16#8401 – and it can be acknowledged using input "AckError".

An infeed unit alarm is displayed using output "Warning" = 1 and "Status" = 16#7200.

If the block is operating without any errors, then at the output "Status" = 16#7002 is displayed.

Note

The user must reset input "AckError" again, as the fault acknowledgment expects an edge change (0→1).

10 Configuration and project engineering

10.1 Configuring a SIMATIC controller S7-1200/1500 with SINAMICS G120 (Startdrive configuration)

Table 10-1

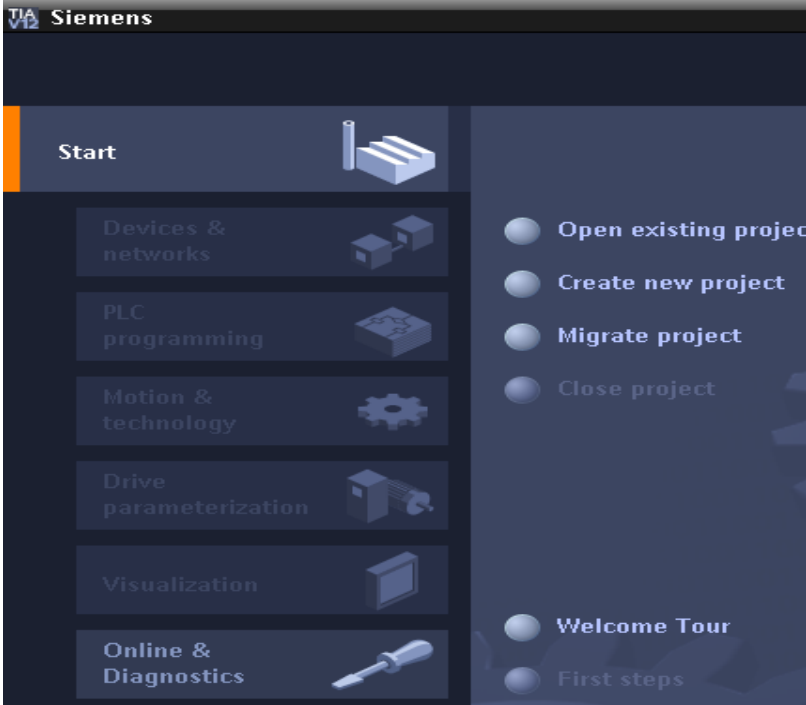
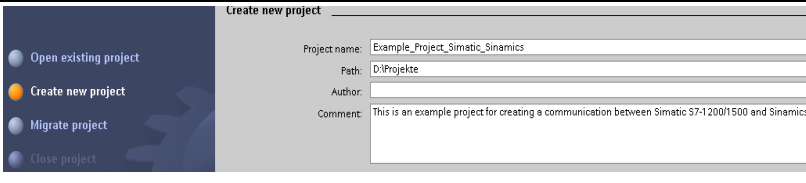
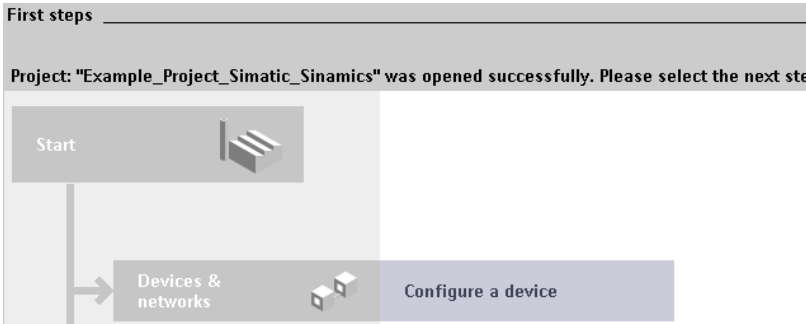
No.	Action	Remark
1.	Start the TIA Portal V13	
2.	Create a new project	
3.	Select a "New device"	

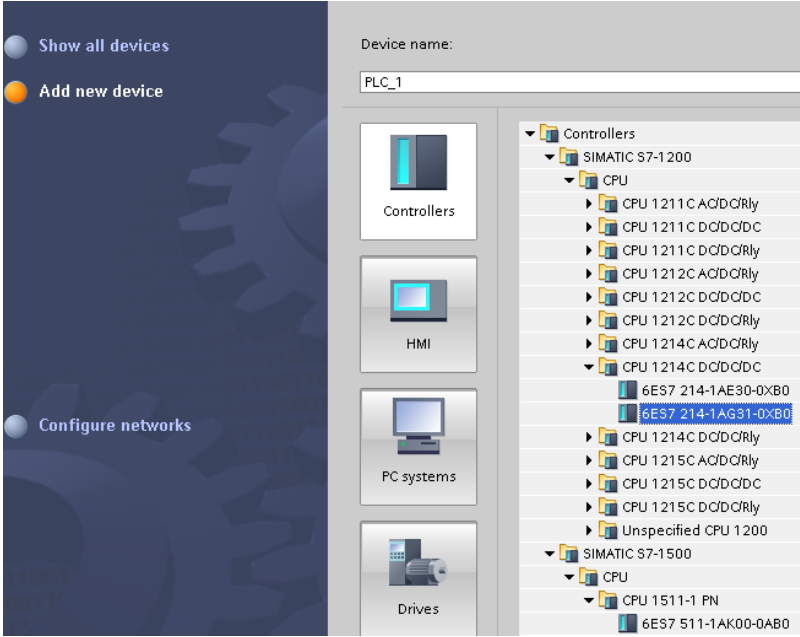
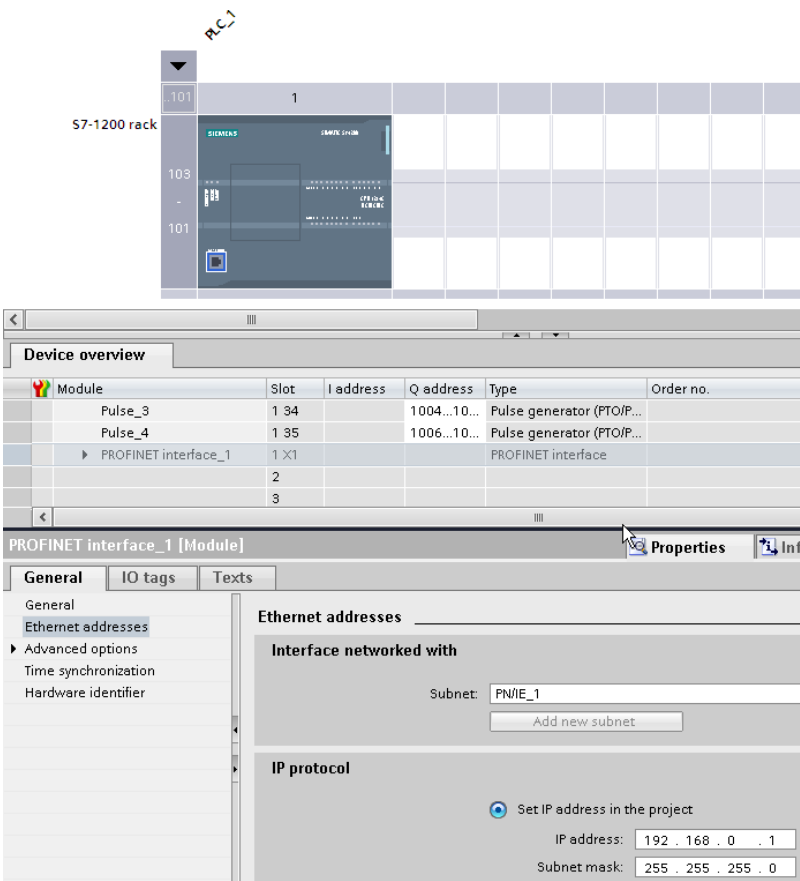
No.	Action	Remark																																				
4.	Select the available SIMATIC S7 controller																																					
5.	Change to the device view and parameterize the interface as well as the IP/DP address	 <p>Device overview</p> <table border="1"> <thead> <tr> <th>Module</th> <th>Slot</th> <th>I address</th> <th>Q address</th> <th>Type</th> <th>Order no.</th> </tr> </thead> <tbody> <tr> <td>Pulse_3</td> <td>1 34</td> <td></td> <td>1004...10...</td> <td>Pulse generator (PTO/P...</td> <td></td> </tr> <tr> <td>Pulse_4</td> <td>1 35</td> <td></td> <td>1006...10...</td> <td>Pulse generator (PTO/P...</td> <td></td> </tr> <tr> <td>PROFINET interface_1</td> <td>1 X1</td> <td></td> <td></td> <td>PROFINET interface</td> <td></td> </tr> <tr> <td></td> <td>2</td> <td></td> <td></td> <td></td> <td></td> </tr> <tr> <td></td> <td>3</td> <td></td> <td></td> <td></td> <td></td> </tr> </tbody> </table> <p>PROFINET interface_1 [Module] Properties</p> <p>Ethernet addresses</p> <p>Interface networked with</p> <p>Subnet: PN/IE_1</p> <p>IP protocol</p> <p><input checked="" type="radio"/> Set IP address in the project</p> <p>IP address: 192 . 168 . 0 . 1</p> <p>Subnet mask: 255 . 255 . 255 . 0</p>	Module	Slot	I address	Q address	Type	Order no.	Pulse_3	1 34		1004...10...	Pulse generator (PTO/P...		Pulse_4	1 35		1006...10...	Pulse generator (PTO/P...		PROFINET interface_1	1 X1			PROFINET interface			2						3				
Module	Slot	I address	Q address	Type	Order no.																																	
Pulse_3	1 34		1004...10...	Pulse generator (PTO/P...																																		
Pulse_4	1 35		1006...10...	Pulse generator (PTO/P...																																		
PROFINET interface_1	1 X1			PROFINET interface																																		
	2																																					
	3																																					

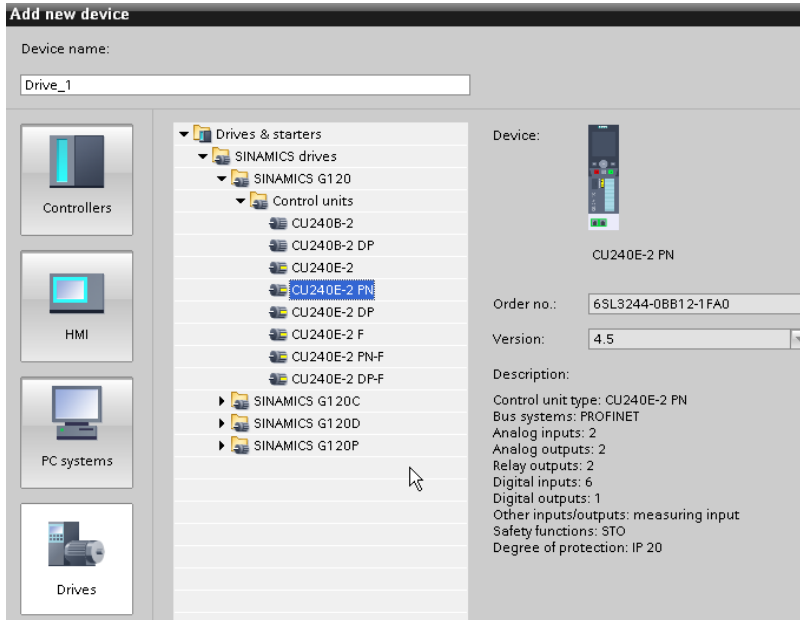
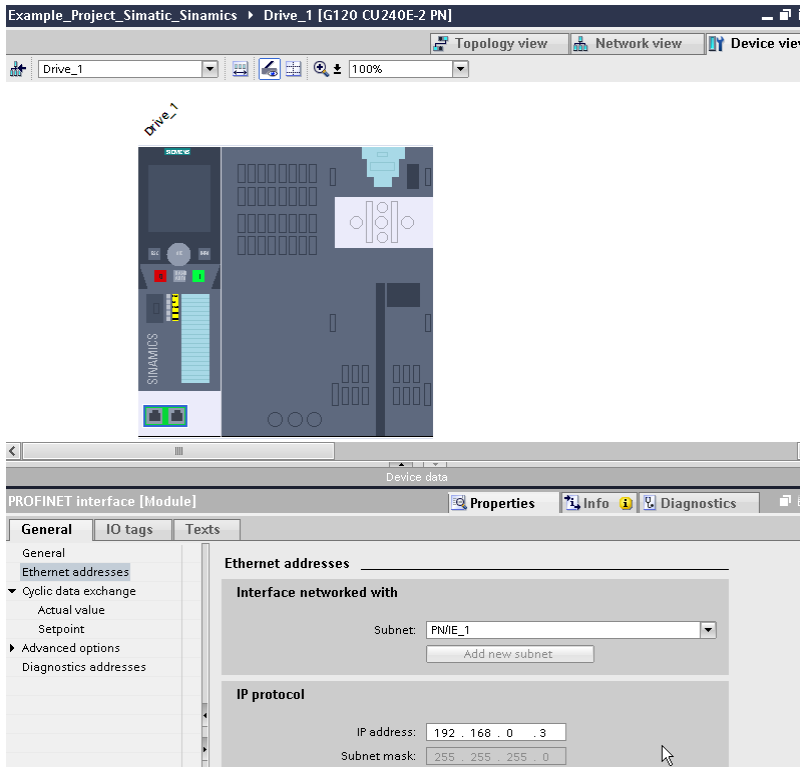
No.	Action	Remark
6.	Create the SINAMICS G120	
7.	Change to the device view and parameterize the power unit as well as the Ethernet address of the SINAMICS G120 IMPORTANT: PROFINET nodes configured with Startdrive are linked as standard with the detailed device name! For the communication to function, this name must be adapted with the device name assigned by the user!	
8.	Online commissioning of the SINAMICS drive	The commissioning of a SINAMICS drive is not considered in this document. Use the SIEMENS product and information pages for further information. (2/)

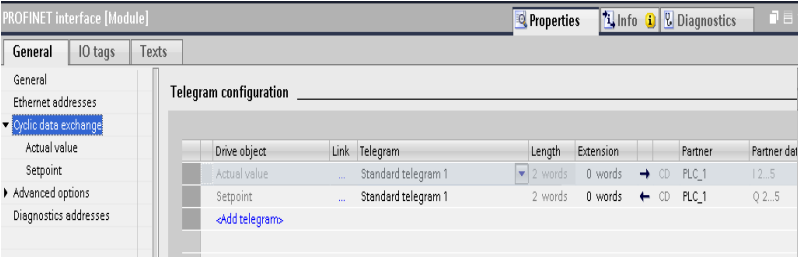
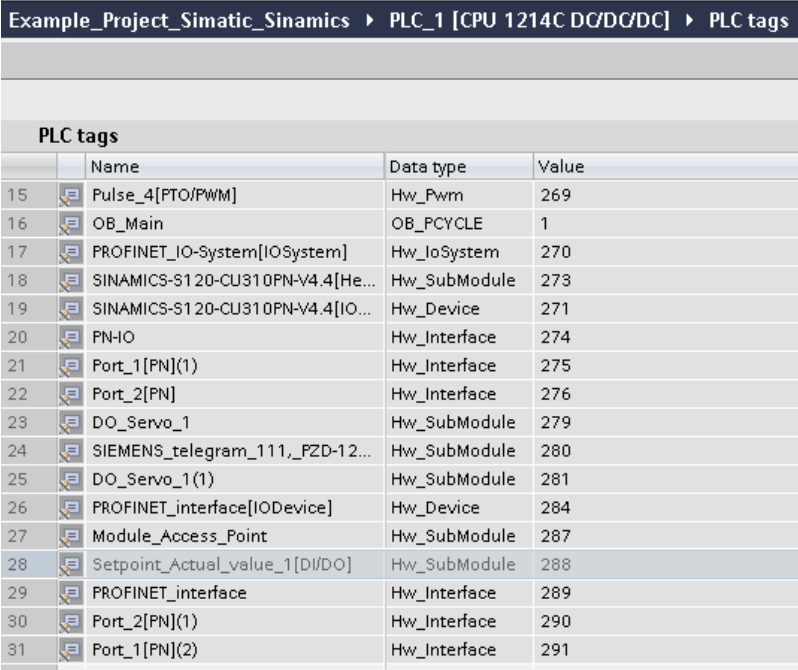
No.	Action	Remark																																																																												
9.	After the online basic commissioning, the selected telegram is displayed in the device view.																																																																													
10.	After the compilation of the hardware → determine the hardware ID of the telegram slot	 <table border="1" data-bbox="549 658 1355 1200"> <thead> <tr> <th colspan="4">PLC tags</th> </tr> <tr> <th></th> <th>Name</th> <th>Data type</th> <th>Value</th> </tr> </thead> <tbody> <tr><td>15</td><td>Pulse_4[PTO/PWM]</td><td>Hw_Pwm</td><td>269</td></tr> <tr><td>16</td><td>OB_Main</td><td>OB_PCYCLE</td><td>1</td></tr> <tr><td>17</td><td>PROFINET_IO-System[IOSystem]</td><td>Hw_IoSystem</td><td>270</td></tr> <tr><td>18</td><td>SINAMICS-S1 20-CU31 0PN-V4.4[He...</td><td>Hw_SubModule</td><td>273</td></tr> <tr><td>19</td><td>SINAMICS-S1 20-CU31 0PN-V4.4[IO...</td><td>Hw_Device</td><td>271</td></tr> <tr><td>20</td><td>PN-IO</td><td>Hw_Interface</td><td>274</td></tr> <tr><td>21</td><td>Port_1[PN](1)</td><td>Hw_Interface</td><td>275</td></tr> <tr><td>22</td><td>Port_2[PN]</td><td>Hw_Interface</td><td>276</td></tr> <tr><td>23</td><td>DO_Servo_1</td><td>Hw_SubModule</td><td>279</td></tr> <tr><td>24</td><td>SIEMENS_telegram_111,_FZD-12...</td><td>Hw_SubModule</td><td>280</td></tr> <tr><td>25</td><td>DO_Servo_1(1)</td><td>Hw_SubModule</td><td>281</td></tr> <tr><td>26</td><td>PROFINET_interface[IODevice]</td><td>Hw_Device</td><td>284</td></tr> <tr><td>27</td><td>Module_Access_Point</td><td>Hw_SubModule</td><td>287</td></tr> <tr><td>28</td><td>Setpoint_Actual_value_1[DI/DO]</td><td>Hw_SubModule</td><td>288</td></tr> <tr><td>29</td><td>PROFINET_interface</td><td>Hw_Interface</td><td>289</td></tr> <tr><td>30</td><td>Port_2[PN](1)</td><td>Hw_Interface</td><td>290</td></tr> <tr><td>31</td><td>Port_1[PN](2)</td><td>Hw_Interface</td><td>291</td></tr> </tbody> </table>	PLC tags					Name	Data type	Value	15	Pulse_4[PTO/PWM]	Hw_Pwm	269	16	OB_Main	OB_PCYCLE	1	17	PROFINET_IO-System[IOSystem]	Hw_IoSystem	270	18	SINAMICS-S1 20-CU31 0PN-V4.4[He...	Hw_SubModule	273	19	SINAMICS-S1 20-CU31 0PN-V4.4[IO...	Hw_Device	271	20	PN-IO	Hw_Interface	274	21	Port_1[PN](1)	Hw_Interface	275	22	Port_2[PN]	Hw_Interface	276	23	DO_Servo_1	Hw_SubModule	279	24	SIEMENS_telegram_111,_FZD-12...	Hw_SubModule	280	25	DO_Servo_1(1)	Hw_SubModule	281	26	PROFINET_interface[IODevice]	Hw_Device	284	27	Module_Access_Point	Hw_SubModule	287	28	Setpoint_Actual_value_1[DI/DO]	Hw_SubModule	288	29	PROFINET_interface	Hw_Interface	289	30	Port_2[PN](1)	Hw_Interface	290	31	Port_1[PN](2)	Hw_Interface	291
PLC tags																																																																														
	Name	Data type	Value																																																																											
15	Pulse_4[PTO/PWM]	Hw_Pwm	269																																																																											
16	OB_Main	OB_PCYCLE	1																																																																											
17	PROFINET_IO-System[IOSystem]	Hw_IoSystem	270																																																																											
18	SINAMICS-S1 20-CU31 0PN-V4.4[He...	Hw_SubModule	273																																																																											
19	SINAMICS-S1 20-CU31 0PN-V4.4[IO...	Hw_Device	271																																																																											
20	PN-IO	Hw_Interface	274																																																																											
21	Port_1[PN](1)	Hw_Interface	275																																																																											
22	Port_2[PN]	Hw_Interface	276																																																																											
23	DO_Servo_1	Hw_SubModule	279																																																																											
24	SIEMENS_telegram_111,_FZD-12...	Hw_SubModule	280																																																																											
25	DO_Servo_1(1)	Hw_SubModule	281																																																																											
26	PROFINET_interface[IODevice]	Hw_Device	284																																																																											
27	Module_Access_Point	Hw_SubModule	287																																																																											
28	Setpoint_Actual_value_1[DI/DO]	Hw_SubModule	288																																																																											
29	PROFINET_interface	Hw_Interface	289																																																																											
30	Port_2[PN](1)	Hw_Interface	290																																																																											
31	Port_1[PN](2)	Hw_Interface	291																																																																											
11.	Configure the blocks using the hardware ID	See Chapter 10.3																																																																												

10.2 Configuring the SIMATIC S7-1200/1500 controller with SINAMICS S120 (GSD configuring)

Table 10-2

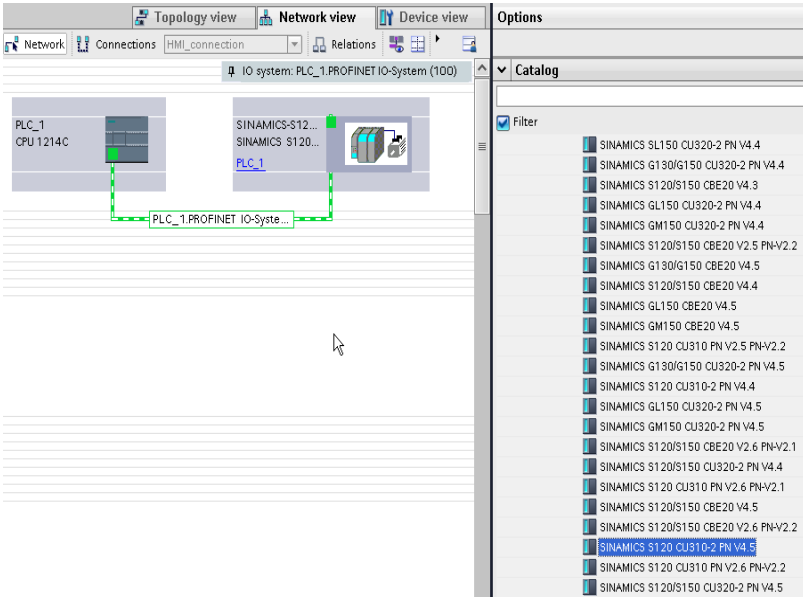
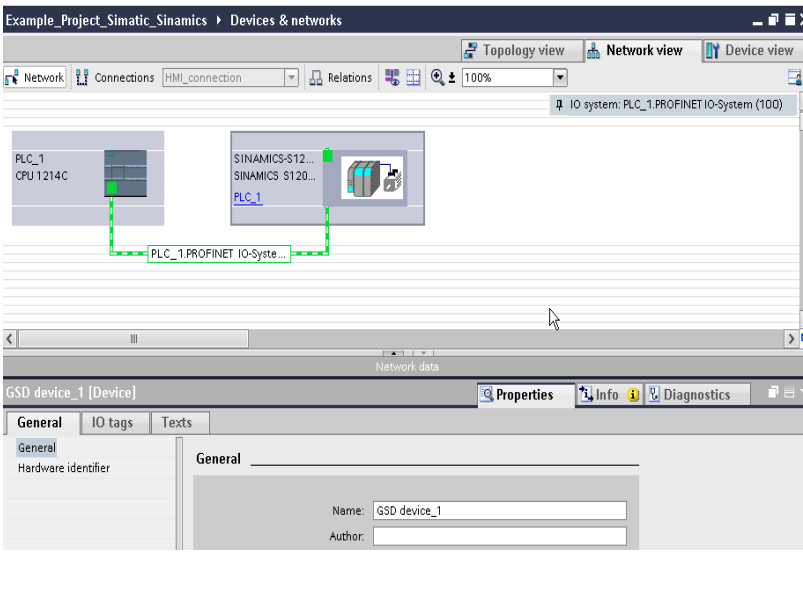
No.	Action	Remark
12.	13. Steps 1 to 5 of Chapter 10.1	14. Create the SIMATIC controller
15.	<p>Change to the network view and configure the communication partners, such as S120, via GSD</p> <p>Important: The drive must be assigned to an appropriate PLC so that HW IDs can be created on the CPU</p>	
16.	<p>IMPORTANT: PROFINET nodes that have been configured with the GSD file are linked as standard with GSD_DEVICE_x!</p> <p>This name must be adapted for a functioning communication with the assigned device name!</p>	

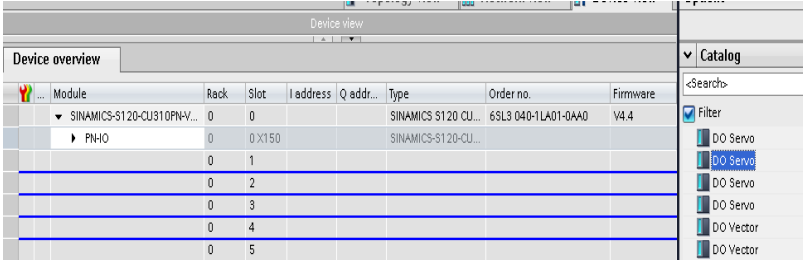
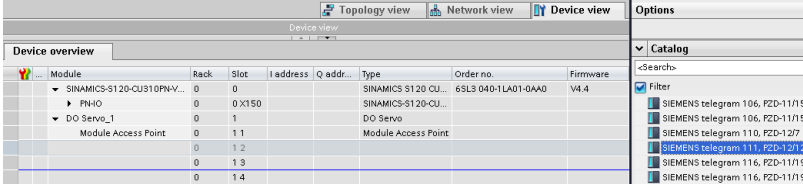
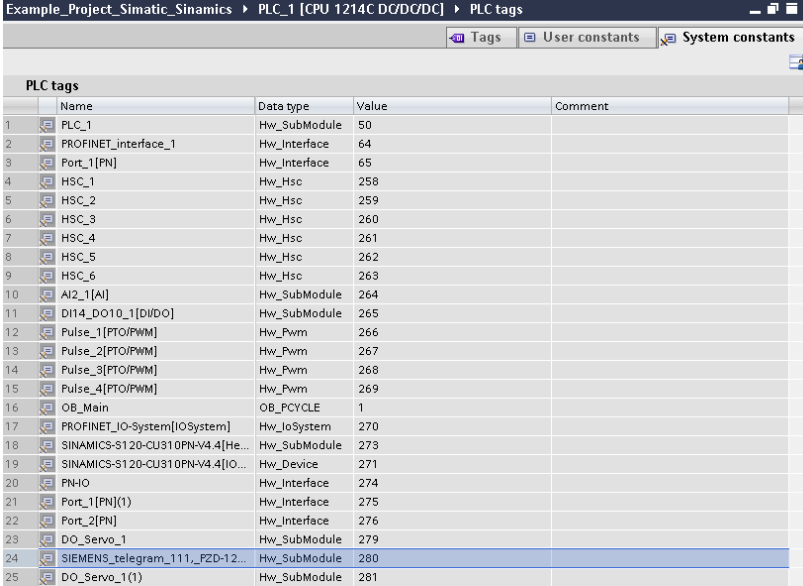
No.	Action	Remark
17.	<p>Configure the drive object in the device view of the SINAMICS drive (GSD configuration)</p> <p>Important: An element can be inserted as soon as the editing area is displayed in the center with blue lines!</p>	
18.	Telegram selection	
19.	<p>After the compilation of the hardware → determine the hardware ID of the telegram slot</p>	
20.	Configure the blocks using the hardware ID	See Chapter 10.3

© Siemens AG 2019. All rights reserved

Note

Use the SIEMENS product and information pages for information on the commissioning of the SINAMICS S120/G120. ([2/](#))

10.3 Selection of the correct hardware submodules

NOTICE	<p>The following screenshots clearly illustrate which hardware IDs are to be used for the communication blocks.</p> <p>For all variants with only one telegram slot or one ID, this value must be entered at both the HWIDSTW and HWIDZSW inputs. For the variant with two assigned IDs, the appropriate ID must be entered at the corresponding input of the cyclic (!) blocks.</p>
---------------	--

Note The telegram names can be adapted individually in a GSD configuration. This makes it easier to find the correct hardware ID in the list of the system constants.

When configuring an S120 multi-axis system, proceed as for the CU310-2 with GSD configuration.

Table 10-3

<p>Configuration without connections</p>																																																																																													
<p>No drive IDs available</p>	<table border="1"> <thead> <tr> <th>Name</th> <th>Data type</th> <th>Value</th> <th>Comment</th> </tr> </thead> <tbody> <tr><td>24</td><td>TPA_22</td><td>Pip</td><td>22</td></tr> <tr><td>25</td><td>TPA_23</td><td>Pip</td><td>23</td></tr> <tr><td>26</td><td>TPA_24</td><td>Pip</td><td>24</td></tr> <tr><td>27</td><td>TPA_25</td><td>Pip</td><td>25</td></tr> <tr><td>28</td><td>TPA_26</td><td>Pip</td><td>26</td></tr> <tr><td>29</td><td>TPA_27</td><td>Pip</td><td>27</td></tr> <tr><td>30</td><td>TPA_28</td><td>Pip</td><td>28</td></tr> <tr><td>31</td><td>TPA_29</td><td>Pip</td><td>29</td></tr> <tr><td>32</td><td>TPA_30</td><td>Pip</td><td>30</td></tr> <tr><td>33</td><td>TPA_31</td><td>Pip</td><td>31</td></tr> <tr><td>34</td><td>TPA OB Servo</td><td>Pip</td><td>32768</td></tr> <tr><td>35</td><td>PLC_1[MC]</td><td>Hw_SubModule</td><td>51</td></tr> <tr><td>36</td><td>PLC_1</td><td>Hw_SubModule</td><td>50</td></tr> <tr><td>37</td><td>PLC_1[Display]</td><td>Hw_SubModule</td><td>54</td></tr> <tr><td>38</td><td>PLC_1[Exec]</td><td>Hw_SubModule</td><td>52</td></tr> <tr><td>39</td><td>DP-Schnittstelle_1</td><td>Hw_Interface</td><td>60</td></tr> <tr><td>40</td><td>PROFINET-Schnittstelle_1</td><td>Hw_Interface</td><td>64</td></tr> <tr><td>41</td><td>Port_1[PN]</td><td>Hw_Interface</td><td>65</td></tr> <tr><td>42</td><td>Port_2[PN]</td><td>Hw_Interface</td><td>66</td></tr> <tr><td>43</td><td>PROFINET-Schnittstelle_2</td><td>Hw_Interface</td><td>72</td></tr> <tr><td>44</td><td>Port_1[PN](1)</td><td>Hw_Interface</td><td>73</td></tr> <tr><td>45</td><td>OB_Main</td><td>OB_PCYCLE</td><td>1</td></tr> </tbody> </table>	Name	Data type	Value	Comment	24	TPA_22	Pip	22	25	TPA_23	Pip	23	26	TPA_24	Pip	24	27	TPA_25	Pip	25	28	TPA_26	Pip	26	29	TPA_27	Pip	27	30	TPA_28	Pip	28	31	TPA_29	Pip	29	32	TPA_30	Pip	30	33	TPA_31	Pip	31	34	TPA OB Servo	Pip	32768	35	PLC_1[MC]	Hw_SubModule	51	36	PLC_1	Hw_SubModule	50	37	PLC_1[Display]	Hw_SubModule	54	38	PLC_1[Exec]	Hw_SubModule	52	39	DP-Schnittstelle_1	Hw_Interface	60	40	PROFINET-Schnittstelle_1	Hw_Interface	64	41	Port_1[PN]	Hw_Interface	65	42	Port_2[PN]	Hw_Interface	66	43	PROFINET-Schnittstelle_2	Hw_Interface	72	44	Port_1[PN](1)	Hw_Interface	73	45	OB_Main	OB_PCYCLE	1
Name	Data type	Value	Comment																																																																																										
24	TPA_22	Pip	22																																																																																										
25	TPA_23	Pip	23																																																																																										
26	TPA_24	Pip	24																																																																																										
27	TPA_25	Pip	25																																																																																										
28	TPA_26	Pip	26																																																																																										
29	TPA_27	Pip	27																																																																																										
30	TPA_28	Pip	28																																																																																										
31	TPA_29	Pip	29																																																																																										
32	TPA_30	Pip	30																																																																																										
33	TPA_31	Pip	31																																																																																										
34	TPA OB Servo	Pip	32768																																																																																										
35	PLC_1[MC]	Hw_SubModule	51																																																																																										
36	PLC_1	Hw_SubModule	50																																																																																										
37	PLC_1[Display]	Hw_SubModule	54																																																																																										
38	PLC_1[Exec]	Hw_SubModule	52																																																																																										
39	DP-Schnittstelle_1	Hw_Interface	60																																																																																										
40	PROFINET-Schnittstelle_1	Hw_Interface	64																																																																																										
41	Port_1[PN]	Hw_Interface	65																																																																																										
42	Port_2[PN]	Hw_Interface	66																																																																																										
43	PROFINET-Schnittstelle_2	Hw_Interface	72																																																																																										
44	Port_1[PN](1)	Hw_Interface	73																																																																																										
45	OB_Main	OB_PCYCLE	1																																																																																										
<p>Selection of S120 CU310-2PN and CU240E-2DP via GSD</p>																																																																																													

© Siemens AG 2019. All rights reserved

<p>Selection of S120 CU310-2PN and CU240E-2DP via GSD</p>	<table border="1"> <tr><td>33</td><td>TPA 31</td><td>Pip</td><td>31</td><td></td><td></td></tr> <tr><td>34</td><td>TPA OB Servo</td><td>Pip</td><td>32768</td><td></td><td></td></tr> <tr><td>35</td><td>PLC_1[MC]</td><td>Hw_SubModule</td><td>51</td><td></td><td></td></tr> <tr><td>36</td><td>PLC_1</td><td>Hw_SubModule</td><td>50</td><td></td><td></td></tr> <tr><td>37</td><td>PLC_1[Display]</td><td>Hw_SubModule</td><td>54</td><td></td><td></td></tr> <tr><td>38</td><td>PLC_1[Exec]</td><td>Hw_SubModule</td><td>52</td><td></td><td></td></tr> <tr><td>39</td><td>DP-Schnittstelle_1</td><td>Hw_Interface</td><td>60</td><td></td><td></td></tr> <tr><td>40</td><td>PROFINET-Schnittstelle_1</td><td>Hw_Interface</td><td>64</td><td></td><td></td></tr> <tr><td>41</td><td>Port_1[PN]</td><td>Hw_Interface</td><td>65</td><td></td><td></td></tr> <tr><td>42</td><td>Port_2[PN]</td><td>Hw_Interface</td><td>66</td><td></td><td></td></tr> <tr><td>43</td><td>PROFINET-Schnittstelle_2</td><td>Hw_Interface</td><td>72</td><td></td><td></td></tr> <tr><td>44</td><td>Port_1[PN](1)</td><td>Hw_Interface</td><td>73</td><td></td><td></td></tr> <tr><td>45</td><td>OB_Main</td><td>OB_PCYCLE</td><td>1</td><td></td><td></td></tr> <tr><td>46</td><td>PROFINET_IO-System[IOSystem]</td><td>Hw_IOSystem</td><td>258</td><td></td><td></td></tr> <tr><td>47</td><td>cu310[Head]</td><td>Hw_SubModule</td><td>275</td><td></td><td></td></tr> <tr><td>48</td><td>cu310[IODevice]</td><td>Hw_Device</td><td>273</td><td></td><td></td></tr> <tr><td>49</td><td>PN-O</td><td>Hw_Interface</td><td>276</td><td></td><td></td></tr> <tr><td>50</td><td>Port_1[PN](2)</td><td>Hw_Interface</td><td>277</td><td></td><td></td></tr> <tr><td>51</td><td>Port_2[PN](1)</td><td>Hw_Interface</td><td>278</td><td></td><td></td></tr> <tr><td>52</td><td>Module_Access_Point</td><td>Hw_SubModule</td><td>281</td><td></td><td></td></tr> <tr><td>53</td><td>cu310_dlg111[AIAO]</td><td>Hw_SubModule</td><td>282</td><td></td><td></td></tr> <tr><td>54</td><td>DO_Servo_1</td><td>Hw_SubModule</td><td>283</td><td></td><td></td></tr> <tr><td>55</td><td>DP-Mastersystem[IOSystem]</td><td>Hw_IOSystem</td><td>259</td><td></td><td></td></tr> <tr><td>56</td><td>CU240E2DP[Head]</td><td>Hw_Interface</td><td>262</td><td></td><td></td></tr> <tr><td>57</td><td>CU240E2DP[DPSlave]</td><td>Hw_DpSlave</td><td>260</td><td></td><td></td></tr> <tr><td>58</td><td>CU240E2DP_TEL1[AIAO]</td><td>Hw_SubModule</td><td>263</td><td></td><td></td></tr> </table>	33	TPA 31	Pip	31			34	TPA OB Servo	Pip	32768			35	PLC_1[MC]	Hw_SubModule	51			36	PLC_1	Hw_SubModule	50			37	PLC_1[Display]	Hw_SubModule	54			38	PLC_1[Exec]	Hw_SubModule	52			39	DP-Schnittstelle_1	Hw_Interface	60			40	PROFINET-Schnittstelle_1	Hw_Interface	64			41	Port_1[PN]	Hw_Interface	65			42	Port_2[PN]	Hw_Interface	66			43	PROFINET-Schnittstelle_2	Hw_Interface	72			44	Port_1[PN](1)	Hw_Interface	73			45	OB_Main	OB_PCYCLE	1			46	PROFINET_IO-System[IOSystem]	Hw_IOSystem	258			47	cu310[Head]	Hw_SubModule	275			48	cu310[IODevice]	Hw_Device	273			49	PN-O	Hw_Interface	276			50	Port_1[PN](2)	Hw_Interface	277			51	Port_2[PN](1)	Hw_Interface	278			52	Module_Access_Point	Hw_SubModule	281			53	cu310_dlg111[AIAO]	Hw_SubModule	282			54	DO_Servo_1	Hw_SubModule	283			55	DP-Mastersystem[IOSystem]	Hw_IOSystem	259			56	CU240E2DP[Head]	Hw_Interface	262			57	CU240E2DP[DPSlave]	Hw_DpSlave	260			58	CU240E2DP_TEL1[AIAO]	Hw_SubModule	263		
33	TPA 31	Pip	31																																																																																																																																																										
34	TPA OB Servo	Pip	32768																																																																																																																																																										
35	PLC_1[MC]	Hw_SubModule	51																																																																																																																																																										
36	PLC_1	Hw_SubModule	50																																																																																																																																																										
37	PLC_1[Display]	Hw_SubModule	54																																																																																																																																																										
38	PLC_1[Exec]	Hw_SubModule	52																																																																																																																																																										
39	DP-Schnittstelle_1	Hw_Interface	60																																																																																																																																																										
40	PROFINET-Schnittstelle_1	Hw_Interface	64																																																																																																																																																										
41	Port_1[PN]	Hw_Interface	65																																																																																																																																																										
42	Port_2[PN]	Hw_Interface	66																																																																																																																																																										
43	PROFINET-Schnittstelle_2	Hw_Interface	72																																																																																																																																																										
44	Port_1[PN](1)	Hw_Interface	73																																																																																																																																																										
45	OB_Main	OB_PCYCLE	1																																																																																																																																																										
46	PROFINET_IO-System[IOSystem]	Hw_IOSystem	258																																																																																																																																																										
47	cu310[Head]	Hw_SubModule	275																																																																																																																																																										
48	cu310[IODevice]	Hw_Device	273																																																																																																																																																										
49	PN-O	Hw_Interface	276																																																																																																																																																										
50	Port_1[PN](2)	Hw_Interface	277																																																																																																																																																										
51	Port_2[PN](1)	Hw_Interface	278																																																																																																																																																										
52	Module_Access_Point	Hw_SubModule	281																																																																																																																																																										
53	cu310_dlg111[AIAO]	Hw_SubModule	282																																																																																																																																																										
54	DO_Servo_1	Hw_SubModule	283																																																																																																																																																										
55	DP-Mastersystem[IOSystem]	Hw_IOSystem	259																																																																																																																																																										
56	CU240E2DP[Head]	Hw_Interface	262																																																																																																																																																										
57	CU240E2DP[DPSlave]	Hw_DpSlave	260																																																																																																																																																										
58	CU240E2DP_TEL1[AIAO]	Hw_SubModule	263																																																																																																																																																										
<p>Selection of S120 CU310-2DP and CU240E-2PN via GSD</p>																																																																																																																																																													
<p>Selection of S120 CU310-2DP and CU240E-2PN via GSD</p>	<table border="1"> <tr><td>36</td><td>PLC_1</td><td>Hw_SubModule</td><td>50</td><td></td><td></td></tr> <tr><td>37</td><td>PLC_1[Display]</td><td>Hw_SubModule</td><td>54</td><td></td><td></td></tr> <tr><td>38</td><td>PLC_1[Exec]</td><td>Hw_SubModule</td><td>52</td><td></td><td></td></tr> <tr><td>39</td><td>DP-Schnittstelle_1</td><td>Hw_Interface</td><td>60</td><td></td><td></td></tr> <tr><td>40</td><td>PROFINET-Schnittstelle_1</td><td>Hw_Interface</td><td>64</td><td></td><td></td></tr> <tr><td>41</td><td>Port_1[PN]</td><td>Hw_Interface</td><td>65</td><td></td><td></td></tr> <tr><td>42</td><td>Port_2[PN]</td><td>Hw_Interface</td><td>66</td><td></td><td></td></tr> <tr><td>43</td><td>PROFINET-Schnittstelle_2</td><td>Hw_Interface</td><td>72</td><td></td><td></td></tr> <tr><td>44</td><td>Port_1[PN](1)</td><td>Hw_Interface</td><td>73</td><td></td><td></td></tr> <tr><td>45</td><td>OB_Main</td><td>OB_PCYCLE</td><td>1</td><td></td><td></td></tr> <tr><td>46</td><td>PROFINET_IO-System[IOSystem]</td><td>Hw_IOSystem</td><td>258</td><td></td><td></td></tr> <tr><td>47</td><td>OB_IO access error</td><td>OB_Any</td><td>122</td><td></td><td></td></tr> <tr><td>48</td><td>OB_Cyclic interrupt</td><td>OB_Cyclic</td><td>80</td><td></td><td></td></tr> <tr><td>49</td><td>CU240E2PN[Head]</td><td>Hw_SubModule</td><td>267</td><td></td><td></td></tr> <tr><td>50</td><td>CU240E2PN[IODevice]</td><td>Hw_Device</td><td>264</td><td></td><td></td></tr> <tr><td>51</td><td>PN-O</td><td>Hw_Interface</td><td>259</td><td></td><td></td></tr> <tr><td>52</td><td>Port_1[PN](2)</td><td>Hw_Interface</td><td>260</td><td></td><td></td></tr> <tr><td>53</td><td>Port_2[PN](1)</td><td>Hw_Interface</td><td>261</td><td></td><td></td></tr> <tr><td>54</td><td>Antrieb_1</td><td>Hw_SubModule</td><td>265</td><td></td><td></td></tr> <tr><td>55</td><td>Antrieb_1(1)</td><td>Hw_SubModule</td><td>274</td><td></td><td></td></tr> <tr><td>56</td><td>CU240E2PN_TEL1[AIAO]</td><td>Hw_SubModule</td><td>273</td><td></td><td></td></tr> <tr><td>57</td><td>DP-Mastersystem[IOSystem]</td><td>Hw_IOSystem</td><td>268</td><td></td><td></td></tr> <tr><td>58</td><td>CU3102DP[Head]</td><td>Hw_Interface</td><td>292</td><td></td><td></td></tr> <tr><td>59</td><td>CU3102DP[DPSlave]</td><td>Hw_DpSlave</td><td>290</td><td></td><td></td></tr> <tr><td>60</td><td>CU3102DP_TEL1[AIAO]</td><td>Hw_SubModule</td><td>293</td><td></td><td></td></tr> </table>	36	PLC_1	Hw_SubModule	50			37	PLC_1[Display]	Hw_SubModule	54			38	PLC_1[Exec]	Hw_SubModule	52			39	DP-Schnittstelle_1	Hw_Interface	60			40	PROFINET-Schnittstelle_1	Hw_Interface	64			41	Port_1[PN]	Hw_Interface	65			42	Port_2[PN]	Hw_Interface	66			43	PROFINET-Schnittstelle_2	Hw_Interface	72			44	Port_1[PN](1)	Hw_Interface	73			45	OB_Main	OB_PCYCLE	1			46	PROFINET_IO-System[IOSystem]	Hw_IOSystem	258			47	OB_IO access error	OB_Any	122			48	OB_Cyclic interrupt	OB_Cyclic	80			49	CU240E2PN[Head]	Hw_SubModule	267			50	CU240E2PN[IODevice]	Hw_Device	264			51	PN-O	Hw_Interface	259			52	Port_1[PN](2)	Hw_Interface	260			53	Port_2[PN](1)	Hw_Interface	261			54	Antrieb_1	Hw_SubModule	265			55	Antrieb_1(1)	Hw_SubModule	274			56	CU240E2PN_TEL1[AIAO]	Hw_SubModule	273			57	DP-Mastersystem[IOSystem]	Hw_IOSystem	268			58	CU3102DP[Head]	Hw_Interface	292			59	CU3102DP[DPSlave]	Hw_DpSlave	290			60	CU3102DP_TEL1[AIAO]	Hw_SubModule	293								
36	PLC_1	Hw_SubModule	50																																																																																																																																																										
37	PLC_1[Display]	Hw_SubModule	54																																																																																																																																																										
38	PLC_1[Exec]	Hw_SubModule	52																																																																																																																																																										
39	DP-Schnittstelle_1	Hw_Interface	60																																																																																																																																																										
40	PROFINET-Schnittstelle_1	Hw_Interface	64																																																																																																																																																										
41	Port_1[PN]	Hw_Interface	65																																																																																																																																																										
42	Port_2[PN]	Hw_Interface	66																																																																																																																																																										
43	PROFINET-Schnittstelle_2	Hw_Interface	72																																																																																																																																																										
44	Port_1[PN](1)	Hw_Interface	73																																																																																																																																																										
45	OB_Main	OB_PCYCLE	1																																																																																																																																																										
46	PROFINET_IO-System[IOSystem]	Hw_IOSystem	258																																																																																																																																																										
47	OB_IO access error	OB_Any	122																																																																																																																																																										
48	OB_Cyclic interrupt	OB_Cyclic	80																																																																																																																																																										
49	CU240E2PN[Head]	Hw_SubModule	267																																																																																																																																																										
50	CU240E2PN[IODevice]	Hw_Device	264																																																																																																																																																										
51	PN-O	Hw_Interface	259																																																																																																																																																										
52	Port_1[PN](2)	Hw_Interface	260																																																																																																																																																										
53	Port_2[PN](1)	Hw_Interface	261																																																																																																																																																										
54	Antrieb_1	Hw_SubModule	265																																																																																																																																																										
55	Antrieb_1(1)	Hw_SubModule	274																																																																																																																																																										
56	CU240E2PN_TEL1[AIAO]	Hw_SubModule	273																																																																																																																																																										
57	DP-Mastersystem[IOSystem]	Hw_IOSystem	268																																																																																																																																																										
58	CU3102DP[Head]	Hw_Interface	292																																																																																																																																																										
59	CU3102DP[DPSlave]	Hw_DpSlave	290																																																																																																																																																										
60	CU3102DP_TEL1[AIAO]	Hw_SubModule	293																																																																																																																																																										
<p>Selection of G120 CU240E-2DP and CU240E-2PN via Startdrive</p>																																																																																																																																																													

<p>Selection of G120 CU240E-2DP and CU240E-2PN via Startdrive</p> <p><i>DP actual value slot</i></p> <p><i>DP setpoint slot</i></p>	<table border="1"> <thead> <tr> <th></th> <th>Name</th> <th>Data type</th> <th>Value</th> <th>Comment</th> </tr> </thead> <tbody> <tr><td>53</td><td>PIP_31</td><td>Pip</td><td>31</td><td></td></tr> <tr><td>54</td><td>PIP_OB_Servo</td><td>Pip</td><td>32768</td><td></td></tr> <tr><td>55</td><td>PLC_2[MC]</td><td>Hw_SubModule</td><td>51</td><td></td></tr> <tr><td>56</td><td>PLC_2</td><td>Hw_SubModule</td><td>50</td><td></td></tr> <tr><td>57</td><td>PLC_2[Display]</td><td>Hw_SubModule</td><td>54</td><td></td></tr> <tr><td>58</td><td>PLC_2[Exec]</td><td>Hw_SubModule</td><td>52</td><td></td></tr> <tr><td>59</td><td>DP_interface_1</td><td>Hw_interface</td><td>60</td><td></td></tr> <tr><td>60</td><td>PROFINET_interface_1</td><td>Hw_interface</td><td>64</td><td></td></tr> <tr><td>61</td><td>Port_1[PN]</td><td>Hw_interface</td><td>65</td><td></td></tr> <tr><td>62</td><td>Port_2[PN]</td><td>Hw_interface</td><td>66</td><td></td></tr> <tr><td>63</td><td>PROFINET_interface_2</td><td>Hw_interface</td><td>72</td><td></td></tr> <tr><td>64</td><td>Port_1[PN](1)</td><td>Hw_interface</td><td>73</td><td></td></tr> <tr><td>65</td><td>OB_Main</td><td>OB_PCYCLE</td><td>1</td><td></td></tr> <tr><td>66</td><td>OB_Cyclic interrupt</td><td>OB_Cyclic</td><td>30</td><td></td></tr> <tr><td>67</td><td>OB_IO access error</td><td>OB_Any</td><td>122</td><td></td></tr> <tr><td>68</td><td>PROFINET_IO-System[IOSystem]</td><td>Hw_IOSystem</td><td>258</td><td></td></tr> <tr><td>69</td><td>PROFINET-Schnittstelle[IODevice]</td><td>Hw_Device</td><td>261</td><td></td></tr> <tr><td>70</td><td>Module_Access_Point</td><td>Hw_SubModule</td><td>264</td><td></td></tr> <tr><td>71</td><td>Sollwert_Istwert_1[DI/DO]</td><td>Hw_SubModule</td><td>265</td><td></td></tr> <tr><td>72</td><td>PROFINET-Schnittstelle</td><td>Hw_interface</td><td>266</td><td></td></tr> <tr><td>73</td><td>Port_2[PN](1)</td><td>Hw_interface</td><td>267</td><td></td></tr> <tr><td>74</td><td>Port_1[PN](2)</td><td>Hw_interface</td><td>268</td><td></td></tr> <tr><td>75</td><td>DP-Mastersystem[IOSystem]</td><td>Hw_IOSystem</td><td>269</td><td></td></tr> <tr><td>76</td><td>Istwert_1[DI]</td><td>Hw_SubModule</td><td>274</td><td></td></tr> <tr><td>77</td><td>Sollwert_1[DO]</td><td>Hw_SubModule</td><td>275</td><td></td></tr> </tbody> </table>		Name	Data type	Value	Comment	53	PIP_31	Pip	31		54	PIP_OB_Servo	Pip	32768		55	PLC_2[MC]	Hw_SubModule	51		56	PLC_2	Hw_SubModule	50		57	PLC_2[Display]	Hw_SubModule	54		58	PLC_2[Exec]	Hw_SubModule	52		59	DP_interface_1	Hw_interface	60		60	PROFINET_interface_1	Hw_interface	64		61	Port_1[PN]	Hw_interface	65		62	Port_2[PN]	Hw_interface	66		63	PROFINET_interface_2	Hw_interface	72		64	Port_1[PN](1)	Hw_interface	73		65	OB_Main	OB_PCYCLE	1		66	OB_Cyclic interrupt	OB_Cyclic	30		67	OB_IO access error	OB_Any	122		68	PROFINET_IO-System[IOSystem]	Hw_IOSystem	258		69	PROFINET-Schnittstelle[IODevice]	Hw_Device	261		70	Module_Access_Point	Hw_SubModule	264		71	Sollwert_Istwert_1[DI/DO]	Hw_SubModule	265		72	PROFINET-Schnittstelle	Hw_interface	266		73	Port_2[PN](1)	Hw_interface	267		74	Port_1[PN](2)	Hw_interface	268		75	DP-Mastersystem[IOSystem]	Hw_IOSystem	269		76	Istwert_1[DI]	Hw_SubModule	274		77	Sollwert_1[DO]	Hw_SubModule	275	
	Name	Data type	Value	Comment																																																																																																																															
53	PIP_31	Pip	31																																																																																																																																
54	PIP_OB_Servo	Pip	32768																																																																																																																																
55	PLC_2[MC]	Hw_SubModule	51																																																																																																																																
56	PLC_2	Hw_SubModule	50																																																																																																																																
57	PLC_2[Display]	Hw_SubModule	54																																																																																																																																
58	PLC_2[Exec]	Hw_SubModule	52																																																																																																																																
59	DP_interface_1	Hw_interface	60																																																																																																																																
60	PROFINET_interface_1	Hw_interface	64																																																																																																																																
61	Port_1[PN]	Hw_interface	65																																																																																																																																
62	Port_2[PN]	Hw_interface	66																																																																																																																																
63	PROFINET_interface_2	Hw_interface	72																																																																																																																																
64	Port_1[PN](1)	Hw_interface	73																																																																																																																																
65	OB_Main	OB_PCYCLE	1																																																																																																																																
66	OB_Cyclic interrupt	OB_Cyclic	30																																																																																																																																
67	OB_IO access error	OB_Any	122																																																																																																																																
68	PROFINET_IO-System[IOSystem]	Hw_IOSystem	258																																																																																																																																
69	PROFINET-Schnittstelle[IODevice]	Hw_Device	261																																																																																																																																
70	Module_Access_Point	Hw_SubModule	264																																																																																																																																
71	Sollwert_Istwert_1[DI/DO]	Hw_SubModule	265																																																																																																																																
72	PROFINET-Schnittstelle	Hw_interface	266																																																																																																																																
73	Port_2[PN](1)	Hw_interface	267																																																																																																																																
74	Port_1[PN](2)	Hw_interface	268																																																																																																																																
75	DP-Mastersystem[IOSystem]	Hw_IOSystem	269																																																																																																																																
76	Istwert_1[DI]	Hw_SubModule	274																																																																																																																																
77	Sollwert_1[DO]	Hw_SubModule	275																																																																																																																																



NOTICE

A drive created with Startdrive for PROFIBUS creates two (!) slots for actual value and setpoint.

The appropriate HWIDSTW / HWIDZSW must be used for these two slots on the cyclic blocks FB284, FB285! FB286 (SINA_PARA) works with the actual value slot ID!

10.4 Configuration of the SIMATIC controller S7-300/400 with SINAMICS G120 (Startdrive and GSD configuration)

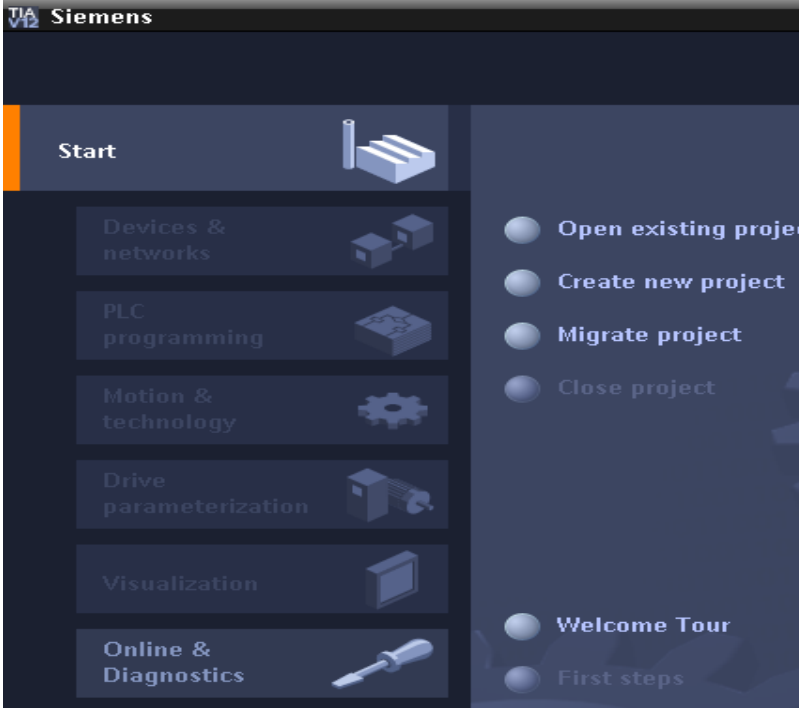
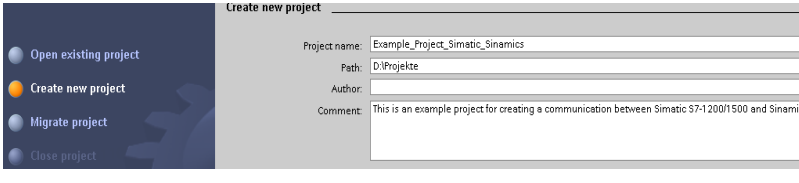
Table 10-4

No.	Action	Remark
1.	Start the TIA Portal V13	
2.	Create a new project	
3.	Select a "New device"	

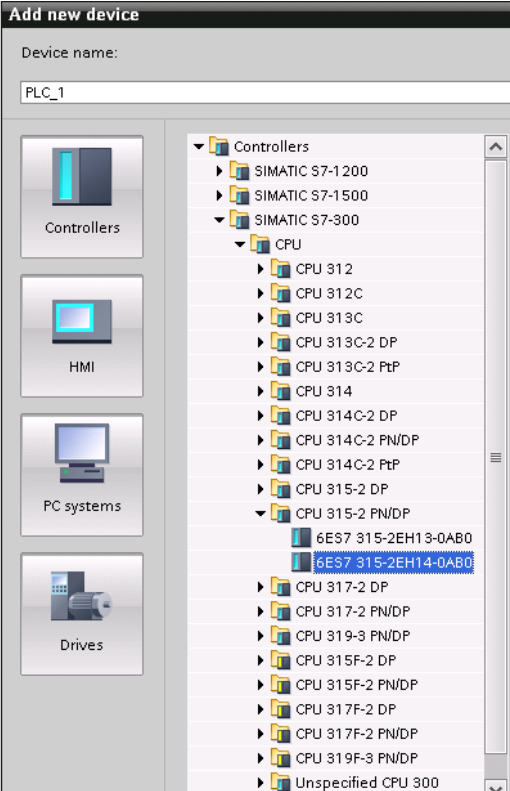
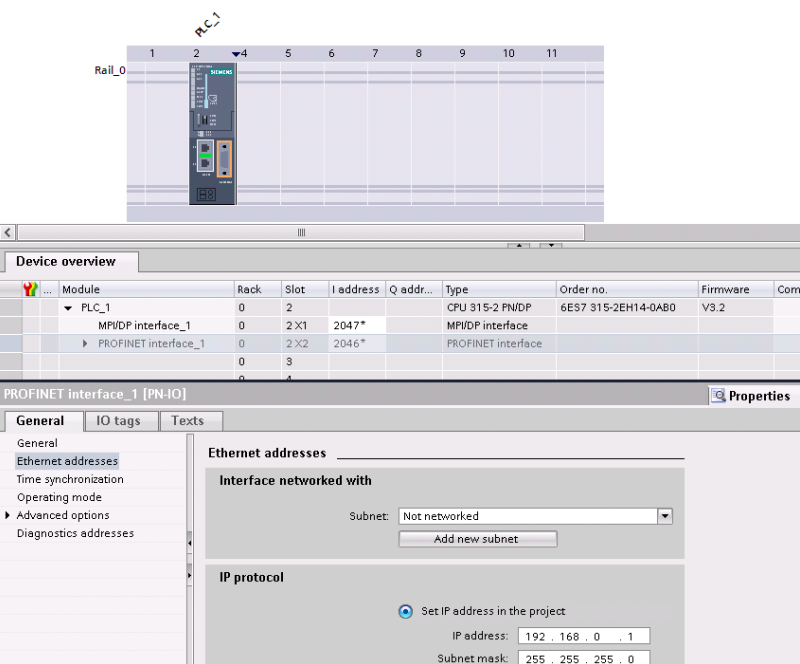
No.	Action	Remark																																													
4.	Select the available SIMATIC S7 controller																																														
5.	Change to the device view and parameterize the interface as well as the IP/DP address	 <table border="1" data-bbox="550 1321 1353 1444"> <caption>Device overview</caption> <thead> <tr> <th>Module</th> <th>Rack</th> <th>Slot</th> <th>I address</th> <th>Q addr...</th> <th>Type</th> <th>Order no.</th> <th>Firmware</th> <th>Com</th> </tr> </thead> <tbody> <tr> <td>PLC_1</td> <td>0</td> <td>2</td> <td></td> <td></td> <td>CPU 315-2 PN/DP</td> <td>6ES7 315-2EH14-0AB0</td> <td>V3.2</td> <td></td> </tr> <tr> <td> MPI/DP interface_1</td> <td>0</td> <td>2 X1</td> <td>2047*</td> <td></td> <td>MPI/DP interface</td> <td></td> <td></td> <td></td> </tr> <tr> <td> PROFINET interface_1</td> <td>0</td> <td>2 X2</td> <td>2046*</td> <td></td> <td>PROFINET interface</td> <td></td> <td></td> <td></td> </tr> <tr> <td> </td> <td>0</td> <td>3</td> <td></td> <td></td> <td></td> <td></td> <td></td> <td></td> </tr> </tbody> </table>	Module	Rack	Slot	I address	Q addr...	Type	Order no.	Firmware	Com	PLC_1	0	2			CPU 315-2 PN/DP	6ES7 315-2EH14-0AB0	V3.2		MPI/DP interface_1	0	2 X1	2047*		MPI/DP interface				PROFINET interface_1	0	2 X2	2046*		PROFINET interface					0	3						
Module	Rack	Slot	I address	Q addr...	Type	Order no.	Firmware	Com																																							
PLC_1	0	2			CPU 315-2 PN/DP	6ES7 315-2EH14-0AB0	V3.2																																								
MPI/DP interface_1	0	2 X1	2047*		MPI/DP interface																																										
PROFINET interface_1	0	2 X2	2046*		PROFINET interface																																										
	0	3																																													

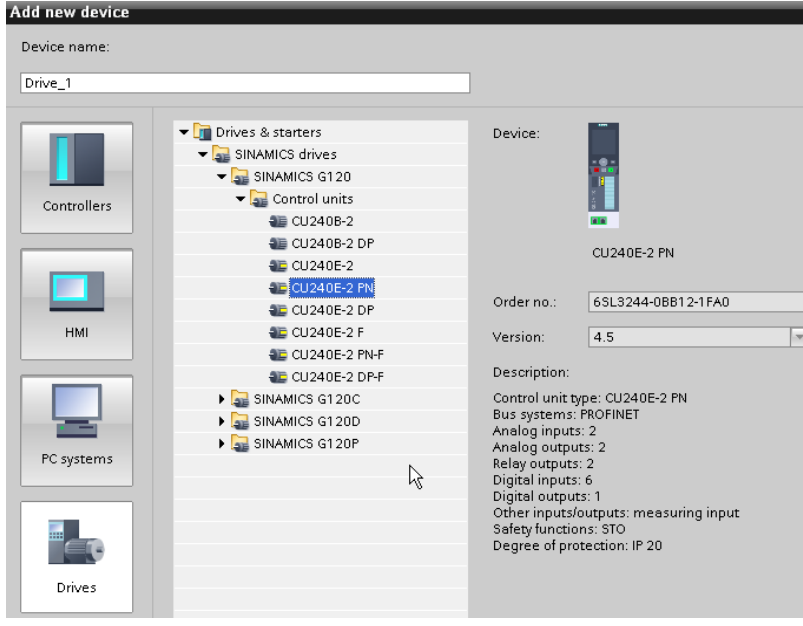
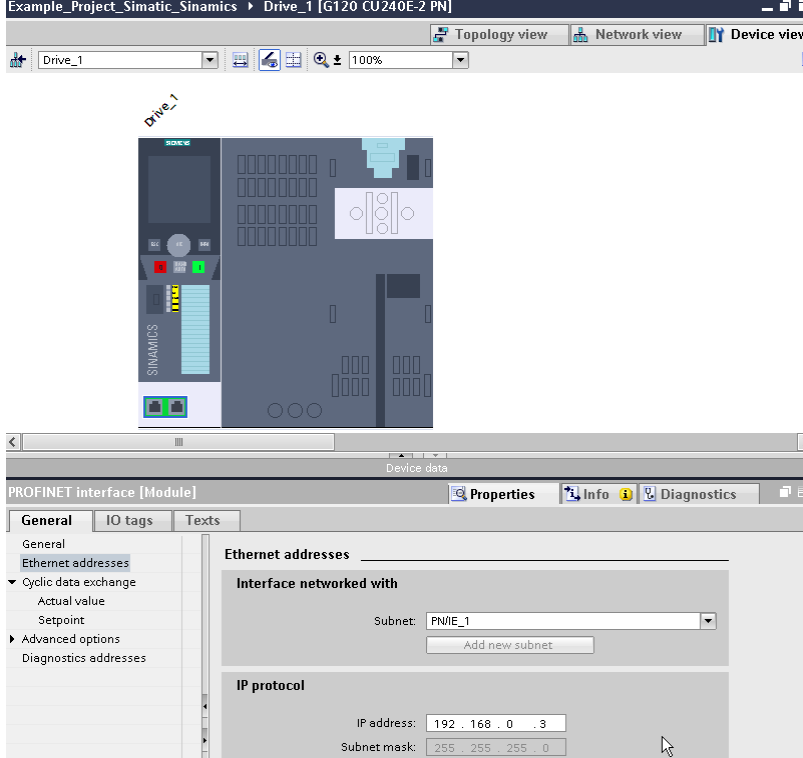
No.	Action	Remark
6.	<p>Create the SINAMICS G120</p>	
7.	<p>Change to the device view and parameterize the power unit as well as the Ethernet address of the SINAMICS G120</p> <p>IMPORTANT: PROFINET nodes configured with Startdrive are linked as standard with the detailed device name! For the communication to function, this name must be adapted with the device name assigned by the user!</p>	
8.	<p>Online commissioning of the SINAMICS drive</p>	<p>The commissioning of a SINAMICS drive is not considered in this document. Use the SIEMENS product and information pages for further information. (2/)</p>

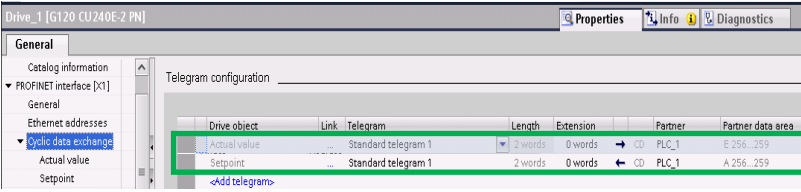
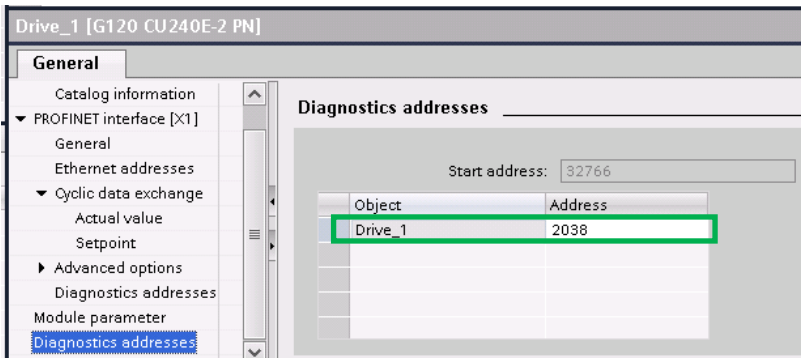
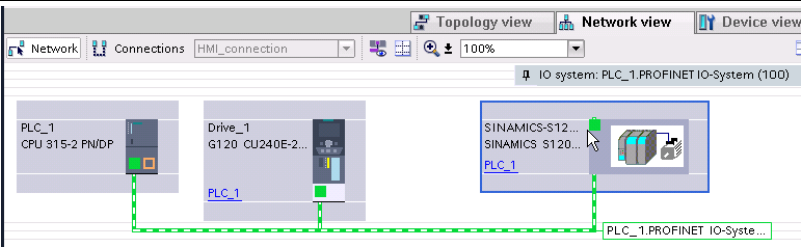
No.	Action	Remark																					
9.	After the online basic commissioning, the selected telegram is displayed in the device view and the IO address is determined.	 <table border="1" data-bbox="724 421 1353 454"> <thead> <tr> <th>Drive object</th> <th>Link</th> <th>Telegram</th> <th>Length</th> <th>Extension</th> <th>Partner</th> <th>Partner data area</th> </tr> </thead> <tbody> <tr> <td>Actual value</td> <td></td> <td>Standard telegram 1</td> <td>2 words</td> <td>0 words</td> <td>CD PLC_1</td> <td>E 256..259</td> </tr> <tr> <td>Setpoint</td> <td></td> <td>Standard telegram 1</td> <td>2 words</td> <td>0 words</td> <td>CD PLC_1</td> <td>A 256..259</td> </tr> </tbody> </table>	Drive object	Link	Telegram	Length	Extension	Partner	Partner data area	Actual value		Standard telegram 1	2 words	0 words	CD PLC_1	E 256..259	Setpoint		Standard telegram 1	2 words	0 words	CD PLC_1	A 256..259
Drive object	Link	Telegram	Length	Extension	Partner	Partner data area																	
Actual value		Standard telegram 1	2 words	0 words	CD PLC_1	E 256..259																	
Setpoint		Standard telegram 1	2 words	0 words	CD PLC_1	A 256..259																	
10.	Determining the diagnostics address	 <table border="1" data-bbox="847 712 1265 768"> <thead> <tr> <th>Object</th> <th>Address</th> </tr> </thead> <tbody> <tr> <td>Drive_1</td> <td>2038</td> </tr> </tbody> </table>	Object	Address	Drive_1	2038																	
Object	Address																						
Drive_1	2038																						
11.	Configuring the blocks, using the I/O address/diagnostics address	See Chapter 10.3																					
12.	Configuring the SINAMICS S120 using GSD																						

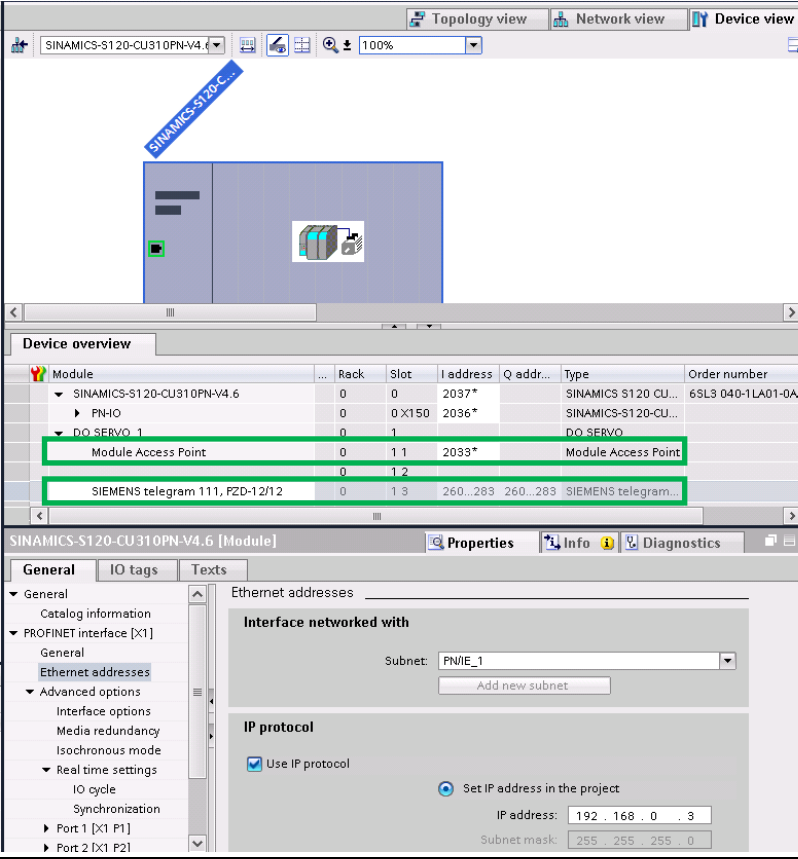
No.	Action	Remark																																																	
	Configuring the SINAMICS S120 (name, IP address, telegram) and determining I/O address/ diagnostics address	 <p>The screenshot shows the SIMATIC Manager interface. At the top, there are tabs for 'Topology view', 'Network view', and 'Device view'. The main area displays a rack diagram with a blue callout for 'SINAMICS-S120-CU...'. Below this is the 'Device overview' table:</p> <table border="1" data-bbox="550 593 1351 772"> <thead> <tr> <th>Module</th> <th>Rack</th> <th>Slot</th> <th>I address</th> <th>Q addr...</th> <th>Type</th> <th>Order number</th> </tr> </thead> <tbody> <tr> <td>SINAMICS-S120-CU310PN-V4.6</td> <td>0</td> <td>0</td> <td>2037*</td> <td></td> <td>SINAMICS S120 CU...</td> <td>6SL3 040-1LA01-0A4</td> </tr> <tr> <td>PNHO</td> <td>0</td> <td>0 X150</td> <td>2036*</td> <td></td> <td>SINAMICS-S120-CU...</td> <td></td> </tr> <tr> <td>DO SERVO 1</td> <td>0</td> <td>1</td> <td></td> <td></td> <td>DO SERVO</td> <td></td> </tr> <tr> <td>Module Access Point</td> <td>0</td> <td>1 1</td> <td>2033*</td> <td></td> <td>Module Access Point</td> <td></td> </tr> <tr> <td></td> <td>0</td> <td>1 2</td> <td></td> <td></td> <td></td> <td></td> </tr> <tr> <td>SIEMENS telegram 111, FZD-12/12</td> <td>0</td> <td>1 3</td> <td>260...263</td> <td>260...263</td> <td>SIEMENS telegram...</td> <td></td> </tr> </tbody> </table> <p>Below the table is the 'Properties' dialog for the selected module. The 'General' tab is active, showing 'Ethernet addresses' and 'IP protocol' settings. The 'Interface networked with' section shows 'Subnet: PN/E_1'. The 'IP protocol' section has 'Use IP protocol' checked and 'Set IP address in the project' selected. The IP address is set to 192.168.0.3 and the subnet mask is 255.255.255.0.</p>	Module	Rack	Slot	I address	Q addr...	Type	Order number	SINAMICS-S120-CU310PN-V4.6	0	0	2037*		SINAMICS S120 CU...	6SL3 040-1LA01-0A4	PNHO	0	0 X150	2036*		SINAMICS-S120-CU...		DO SERVO 1	0	1			DO SERVO		Module Access Point	0	1 1	2033*		Module Access Point			0	1 2					SIEMENS telegram 111, FZD-12/12	0	1 3	260...263	260...263	SIEMENS telegram...	
Module	Rack	Slot	I address	Q addr...	Type	Order number																																													
SINAMICS-S120-CU310PN-V4.6	0	0	2037*		SINAMICS S120 CU...	6SL3 040-1LA01-0A4																																													
PNHO	0	0 X150	2036*		SINAMICS-S120-CU...																																														
DO SERVO 1	0	1			DO SERVO																																														
Module Access Point	0	1 1	2033*		Module Access Point																																														
	0	1 2																																																	
SIEMENS telegram 111, FZD-12/12	0	1 3	260...263	260...263	SIEMENS telegram...																																														

10.5 Configuration of the blocks

Note The DriveLib library is automatically installed along with the installation of Startdrive.

A SIOS entry (109475044) is available to update the library, from where the current versions of the library can be downloaded.

Note The installation routine changes from TIA / Startdrive V14. For more information, see Chapter 10.5.3.

10.5.1 Installing the block library up to and including TIA Portal V13SP1

Note When using the blocks, the library can be downloaded from the Internet free of charge from the SIEMENS product and information pages.

The blocks have been released as of TIA Portal version V12 SP1 and can be used.

Installing the Drive Library S7-300/400/1200/1500 up to and including TIA Portal V13SP1

Table 10-5

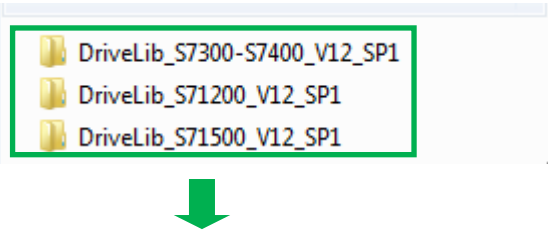
No.	Action	Remark
1	Download the library from the SIEMENS product and information pages and unzip the library to an arbitrary directory	https://support.industry.siemens.com/cs/ww/de/view/109475044
2	Copy the unzipped directories...	

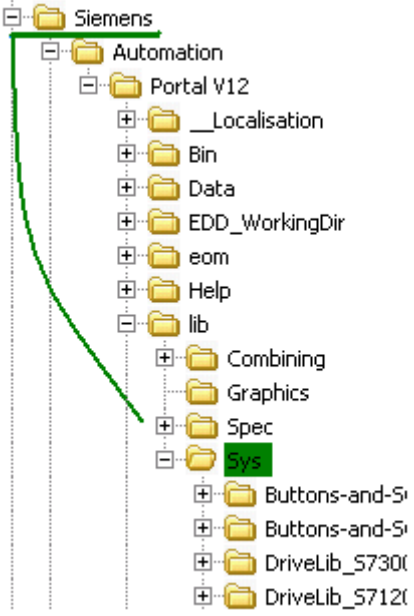
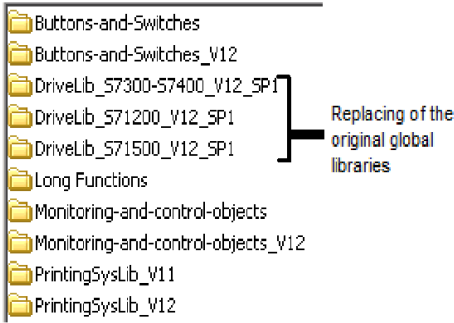
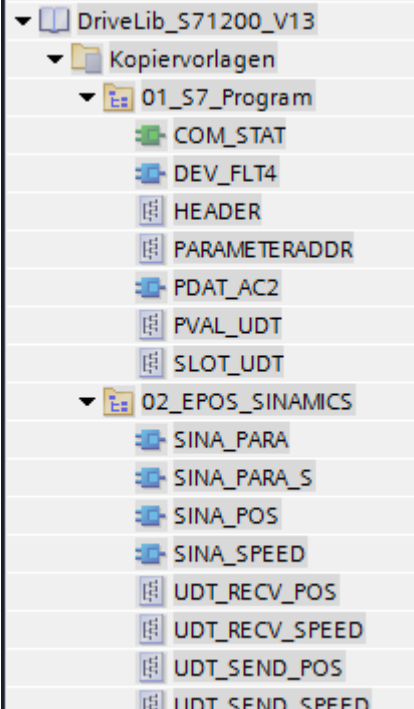
No.	Action	Remark
3	<p>...to the "Sys" installation folder of the TIA Portal installation.</p> <p>Tip: The "Sys" folder of the TIA Portal can be found, for example, using the Windows search for [*.as12].</p>	
4	View of the "Sys" folder after copying the libraries	
5	View of the installed libraries for an S7-1200	

No.	Action	Remark
6	View of the installed libraries for an S7-1500	<ul style="list-style-type: none"> ▼ DriveLib_S71500_V13 <ul style="list-style-type: none"> ▼ Kopiervorlagen <ul style="list-style-type: none"> ▼ 01_S7_Program <ul style="list-style-type: none"> COM_STAT DEV_FLT4 HEADER PARAMETERADDR PCD_RECV PCD_SEND PDAT_AC2 PDAT_UD2 PVAL_UDT SLOT_UDT ▼ 02_EPOS_SINAMICS <ul style="list-style-type: none"> SINA_PARA SINA_PARA_S SINA_POS SINA_SPEED UDT_RECV_POS UDT_RECV_SPEED UDT_SEND_POS UDT_SEND_SPEED

No.	Action	Remark
7	View of the installed libraries for an S7-300/400	

© Siemens AG 2019. All rights reserved.

10.5.2 Inserting the blocks in the project

Table 10-6

No.	Action	Remark
1.	Change to the program processing / project view	

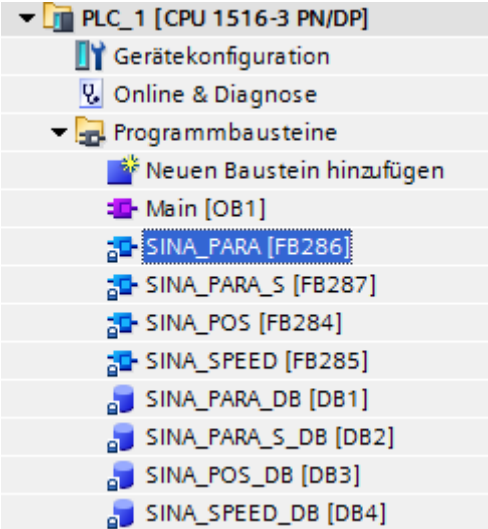
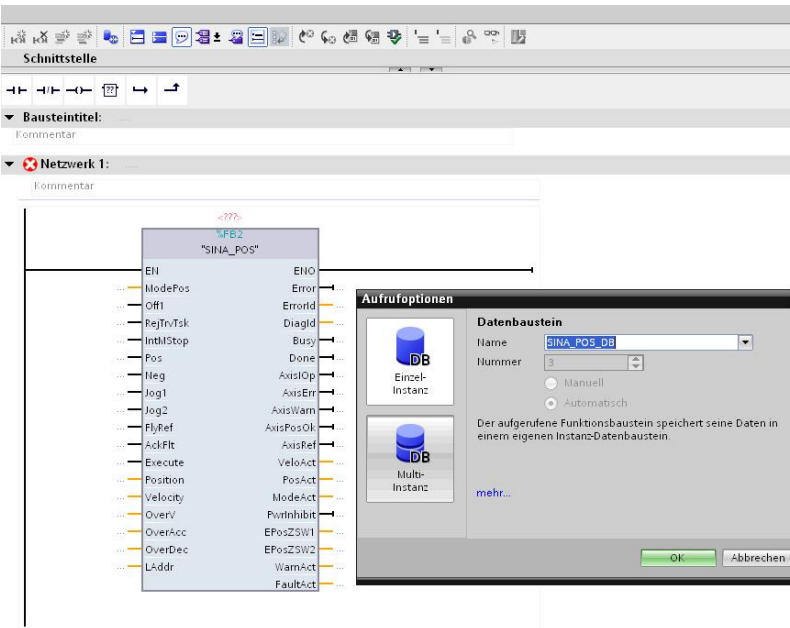

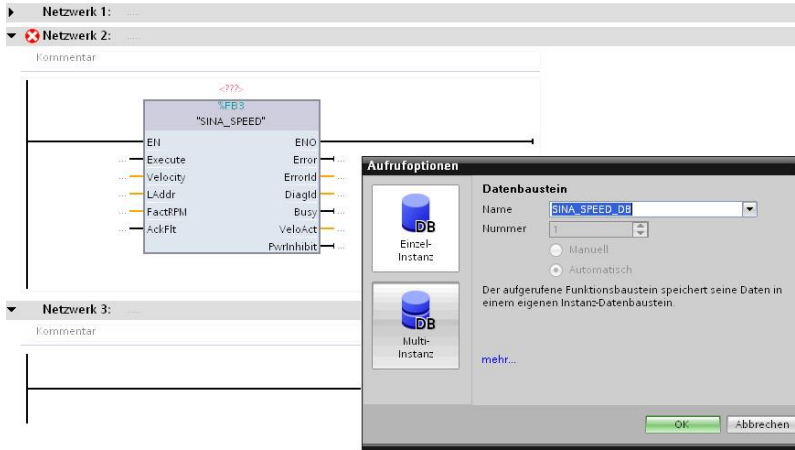
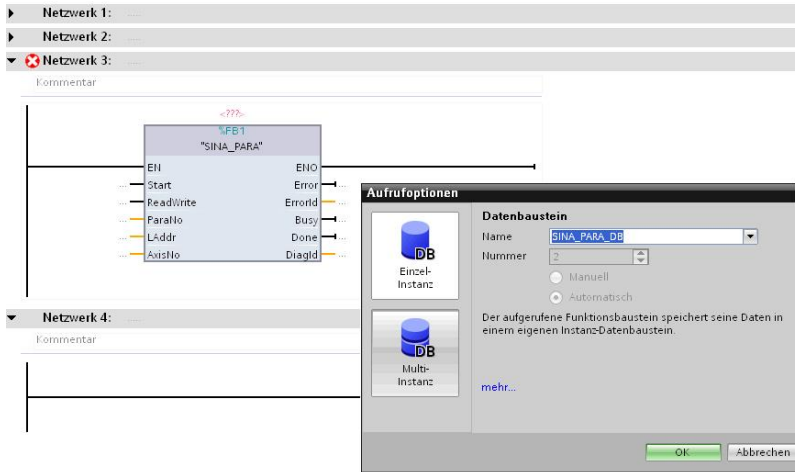
No.	Action	Remark
2.	Change to the library and select the blocks to be used for the respective SIMATIC S7 CPU	See Chapter 5.5
3.	Integrate the blocks in the block folder	
4.	<p>Insert the SINA_POS block, for example, in the main (OB1) block</p> <p>Important: When creating, an instance data block is generated automatically; a name and a number must be assigned for the data block in this step.</p>	

No.	Action	Remark
5.	<p>Insert the SINA_SPEED block, for example, in the main (OB1) block</p> <p>Important: When creating, an instance data block is generated automatically, whereby a name and a number must be assigned for the data block in this step.</p>	
6.	<p>Insert the SINA_PARA block, for example, in the main (OB1) block</p> <p>Important: When creating, an instance data block is generated automatically, whereby a name and a number must be assigned for the data block in this step.</p>	

Note



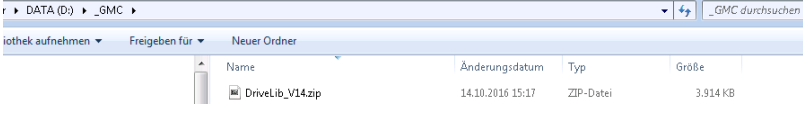
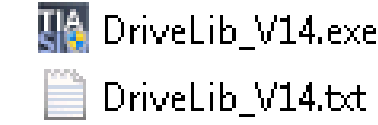
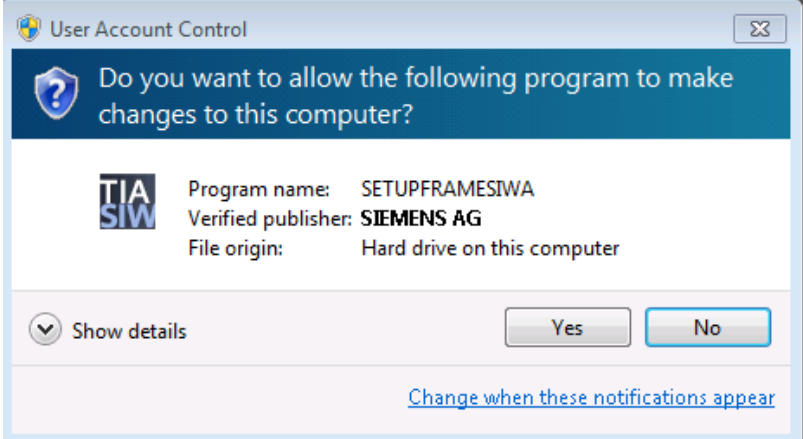



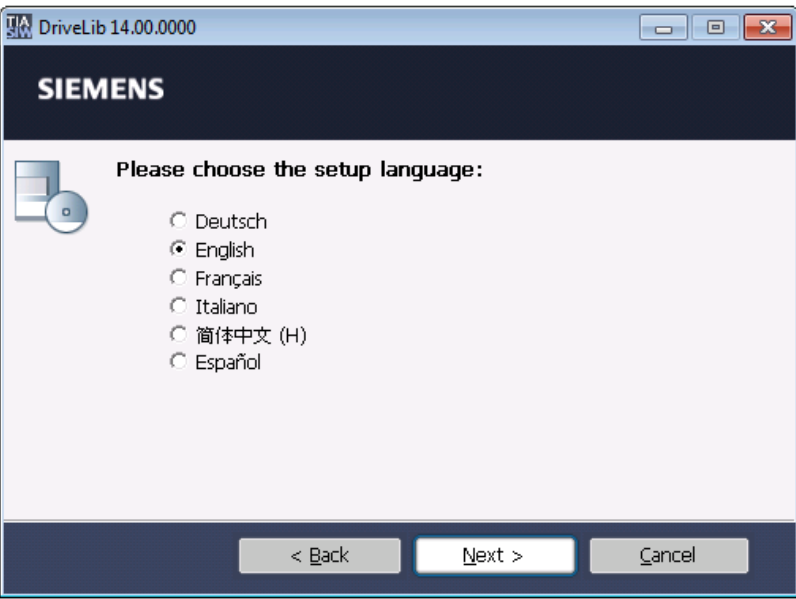
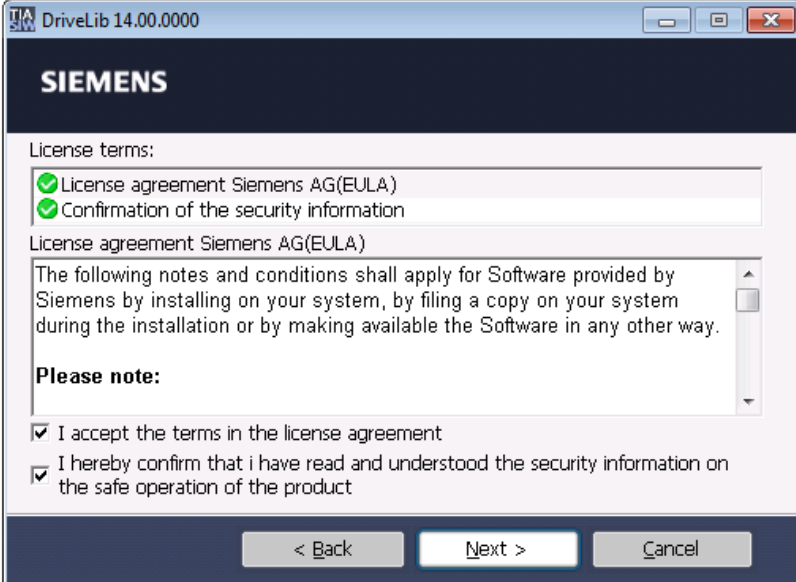

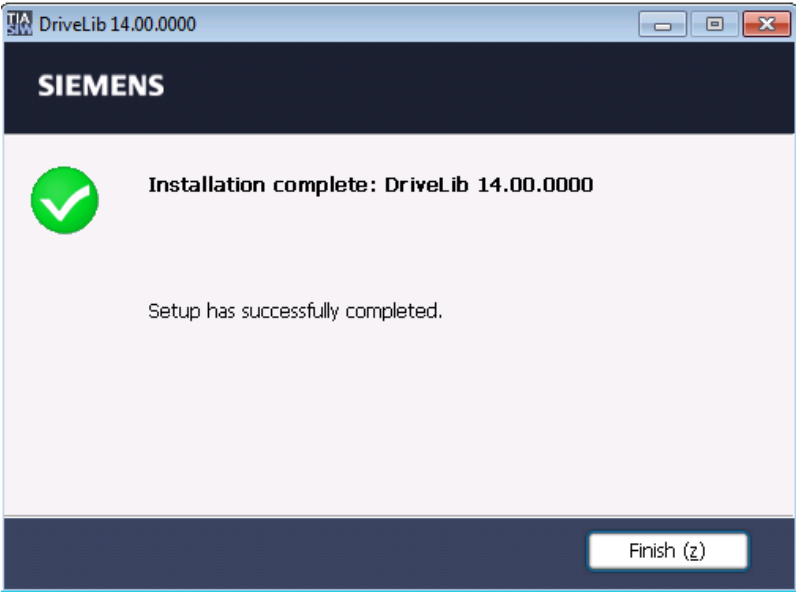
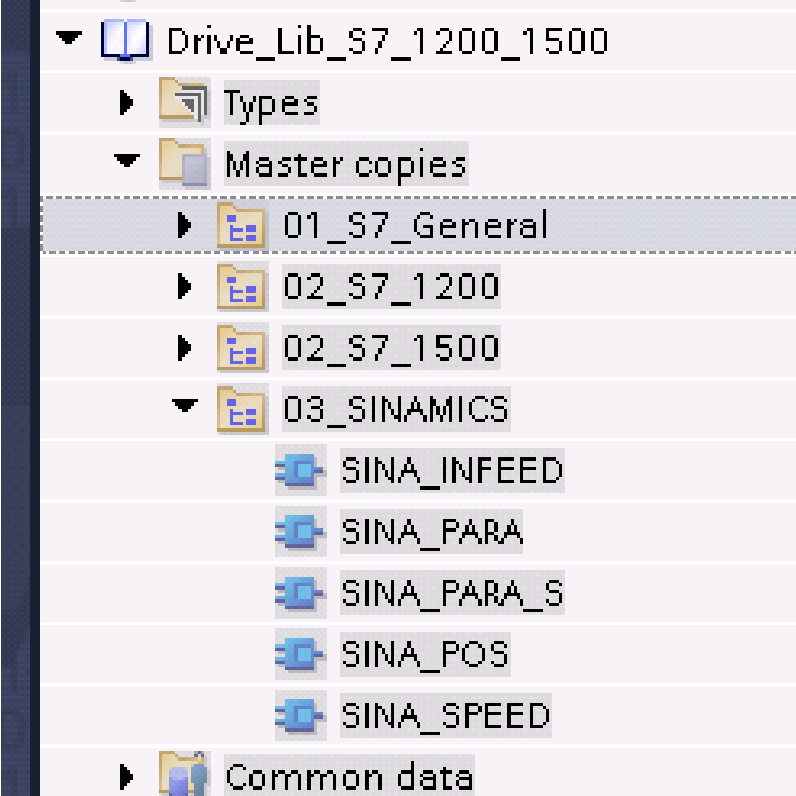











The parameterization of the input and output signals of each block depends on the type of the respective input or output – see Chapter 5 till 9.
The blocks are created with default values so that signals that are not required do not have to be interconnected by the user!

10.5.3 Installing the block library up to and including TIA Portal V14

No.	Action	Remark
1	Download the library from the SIEMENS product and information pages and unzip the library to an arbitrary directory	<p>https://support.industry.siemens.com/cs/ww/de/view/109475044</p> 
2	Run the DriveLib_V14.Exe provided IMPORTANT: A library installed by Startdrive V14 is automatically overwritten with the installation	<p>Name</p> 
3	Confirm installation step 1 with "Yes".	
4	Confirm installation step 2 with "Next"	

No.	Action	Remark
5	Confirm installation step 3 with "Next"; select the setup language	
6	Confirm installation step 4 with "Next"; confirm the license terms as well as the security notes	

No.	Action	Remark
7	Complete the installation	
8	Content of DriveLib with the SINA_XXX blocks	

No.	Action	Remark
9	Content of DriveLib with the SINA_XXX blocks	<ul style="list-style-type: none"> ▼  Drive_Lib_S7_300_400 <ul style="list-style-type: none"> ▶  Types ▼  Master copies <ul style="list-style-type: none"> ▶  01_S7_Program ▶  02_PCD_COM ▼  03_EPOS_SINAMICS <ul style="list-style-type: none">  SINA_PARA  SINA_PARA_S  SINA_POS  SINA_SPEED ▼  SINA_FB <ul style="list-style-type: none">  SINA_FB  UDT_64TraversingBlocks  UDT_Basis  UDT_FaultBuffer  UDT_SpeedControl  UDT_TVB+MDI_APC  UDT_TVB+MDI_TLG110  UDT_TVB+MDI_TLG111 ▶  Common data

11 Examples of acyclic communication with SINA_PARA (FB286)

11.1 Copy RAM to ROM

Table 11-1

Structure parameter	Data set information	Comment
sxParameter[1].siParaNo	p977	The Control Unit must be selected as hardware ID.
sxParameter[1].siIndex	0	
sxParameter[1].srValue	1	
ReadWrite	1	Select write operation
Start	1	Start of the job

11.2 Absolute encoder adjustment

NOTICE	The steps for the absolute encoder adjustment are sequential, i.e. they must be performed one after the other! This is the reason that only the first structure [1] is used in the data block.
---------------	---

Table 11-2

Structure parameter	Data set information	Comment
sxParameter[1].siParaNo	p2599	Selection of the hardware ID of the axis Writing the reference coordinate in [LU]
sxParameter[1].siIndex	0	
sxParameter[1].srValue	xxxxxxx[LU]	
ReadWrite	1	Select write operation
Start	1	Start of the job

Table 11-3

Structure parameter	Data set information	Comment
sxParameter[1].siParaNo	p2507	If an encoder other than the motor encoder is to be used, then the index must be adapted!
sxParameter[1].siIndex	0	
sxParameter[1].srValue	2	
ReadWrite	1	Select write operation
Start	1	Start of the job

Table 11-4

Structure parameter	Data set information	Comment
sxParameter[1].siParaNo	p977	The Control Unit must be selected as hardware ID.
sxParameter[1].siIndex	0	
sxParameter[1].srValue	1	
ReadWrite	1	Select write operation
Start	1	Start of the job

11.3 Writing the up/down ramp of the ramp-function generator

Table 11-5

Structure parameter	Data set information	Comment
sxParameter[1].siParaNo sxParameter[1].siIndex sxParameter[1].srValue	p1120 0 xxxx[s]	Selection of the hardware ID of the drive If the values of another data set are changed, then the index must be adapted accordingly.
sxParameter[2].siParaNo sxParameter[2].siIndex sxParameter[2].srValue	p1121 0 xxxx[s]	
ReadWrite	1	Select write operation
Start	1	Start of the job

Table 11-6

Structure parameter	Data set information	Comment
sxParameter[1].siParaNo sxParameter[1].siIndex sxParameter[1].srValue	p977 0 1	The Control Unit must be selected as hardware ID.
ReadWrite	1	Select write operation
Start	1	Start of the job

11.4 Jog velocity / incremental distance

Writing the jog velocities

Table 11-7

Structure parameter	Data set information	Comment
sxParameter[1].siParaNo sxParameter[1].siIndex sxParameter[1].srValue	p2585 0 xxxx[1000*LU/min]	The axis must be selected as hardware ID
sxParameter[2].siParaNo sxParameter[2].siIndex sxParameter[2].srValue	p2586 0 xxxx[1000*LU/min]	
ReadWrite	1	Select write operation
Start	1	Start of the job

Writing the incremental distance

Table 11-8

Structure parameter	Data set information	Comment
sxParameter[1].siParaNo sxParameter[1].siIndex sxParameter[1].srValue	p2587 0 xxxx[LU]	The axis must be selected as hardware ID
sxParameter[2].siParaNo sxParameter[2].siIndex sxParameter[2].srValue	p2588 0 xxxx[LU]	
ReadWrite	1	Select write operation
Start	1	Start of the job

Table 11-9

Structure parameter	Data set information	Comment
sxParameter[1].siParaNo sxParameter[1].siIndex sxParameter[1].srValue	p977 0 1	The Control Unit must be selected as hardware ID.
ReadWrite	1	Select write operation
Start	1	Start of the job

11.5 Reading the actual fault buffer

Table 11-10

Structure parameter	Data set information	Comment
sxParameter[1].siParaNo	r945	
sxParameter[1].siIndex	0	
sxParameter[1].srValue	xxxx	
sxParameter[2].siParaNo	r945	
sxParameter[2].siIndex	1	
sxParameter[2].srValue	xxxx	
sxParameter[3].siParaNo	r945	
sxParameter[3].siIndex	2	
sxParameter[3].srValue	xxxx	
sxParameter[4].siParaNo	r945	
sxParameter[4].siIndex	3	
sxParameter[4].srValue	xxxx	
sxParameter[5].siParaNo	r945	
sxParameter[5].siIndex	4	
sxParameter[5].srValue	xxxx	
sxParameter[6].siParaNo	r945	
sxParameter[6].siIndex	5	
sxParameter[6].srValue	xxxx	
sxParameter[7].siParaNo	r945	
sxParameter[7].siIndex	6	
sxParameter[7].srValue	xxxx	
sxParameter[8].siParaNo	r945	
sxParameter[8].siIndex	7	
sxParameter[8].srValue	xxxx	
sxParameter[9].siParaNo	r949	
sxParameter[9].siIndex	0	
sxParameter[9].srValue	xxxx	
sxParameter[10].siParaNo	r949	
sxParameter[10].siIndex	1	
sxParameter[10].srValue	xxxx	
sxParameter[11].siParaNo	r949	
sxParameter[11].siIndex	2	
sxParameter[11].srValue	xxxx	
sxParameter[12].siParaNo	r949	
sxParameter[12].siIndex	3	
sxParameter[12].srValue	xxxx	
sxParameter[13].siParaNo	r949	

Structure parameter	Data set information	Comment
sxParameter[13].siIndex sxParameter[13].srValue	4 xxxx	
sxParameter[14].siParaNo sxParameter[14].siIndex sxParameter[14].srValue	r949 5 xxxx	
sxParameter[15].siParaNo sxParameter[15].siIndex sxParameter[15].srValue	r949 6 xxxx	
sxParameter[16].siParaNo sxParameter[16].siIndex sxParameter[16].srValue	r949 7 xxxx	
ReadWrite	0	Select read operation
Start	1	Start of the job

Note

The results of the job are stored in the respective parameters of the `sxParameter[x]srValue` structure.

12 Appendix

12.1 EPos telegram 111

PZD	Assignment of the process data
PZD1	Control word 1
PZD2	EPosSTW 1
PZD3	EPosSTW 2
PZD4	Control word 2
PZD5	Velocity override for all operating modes (4000HEX = 100%)
PZD6	Position setpoint in [LU] for direct setpoint specification / MDI mode
PZD7	
PZD8	Velocity setpoint in the MDI mode
PZD9	
PZD10	Acceleration override for direct setpoint input / MDI mode
PZD11	Deceleration override for direct setpoint input / MDI mode
PZD12	Reserved

Assignment of control word 1

Bit	Abbr.	Designation (Description of the HIGH level)	Drive parameter	Function diagram
0	Off1	ON command: 0 = OFF1 active, 1 = ON	p840	2501
1	Off2	0 =: OFF2 active 1 = signal: Operating condition No coasting down active	p844	2501
2	Off3	0 = OFF3 active 1 = operating condition no rapid stop active	p848	2501
3	Enc	Enable inverter	p852	2501
4	RejTrvTsk	Traversing blocks and direct setpoint input / MDI Reject traversing task 0 = active traversing command is rejected / axis brakes with 100% deceleration override 1 = do not reject traversing task (axis can be traversed)	p2641	3616
5	IntMStop	Intermediate STOP traversing blocks and MDI/direct setpoint input – intermediate stop 0 = active traversing command is interrupted / axis brakes with specified deceleration override 1 = no intermediate stop (axis can be traversed)	p2640	3616
6	TrvStart	Activate traversing task Setpoint acceptance edge if MdiTyp = 0	p2631 p2650	3640 3620
7	AckFault	Acknowledge fault	p2103	2501
8	Jog1	Jog signal source 1	p2589	3610
9	Jog2	Jog signal source 2	p2590	3610
10	LB	Life bit (control requested from PLC)	p854	2501
11	RefStart	Start referencing	p2595	3612
12	Bit12	Reserved		

Bit	Abbr.	Designation (Description of the HIGH level)	Drive parameter	Function diagram
13	Bit13	External block change (0->1)	<not used> (p2633)	
14	Bit14	Reserved		
15	Bit15	Reserved		

Assignment of EPosSTW 1

Bit	Abbr.	Designation	Drive parameter	Function diagram
	TrvBit0	Block selection, bit 0	p2625	3640
1	TrvBit1	Block selection, bit 1	p2626	3640
2	TrvBit2	Block selection, bit 2	p2627	3640
3	TrvBit3	Block selection, bit 3	p2628	3640
4	TrvBit4	Block selection, bit 4	p2629	3640
5	TrvBit5	Block selection, bit 5	p2630	3640
6	Bit6	Reserved		
7	Bit7	Reserved		
8	MdiTyp	Positioning type 0 = relative positioning 1 = absolute positioning	p2648	3620
9	MdiPos	Direction selection for the setup, or absolute positioning of rotary axes, in positive direction	p2651	3620
10	MdiNeg	Direction selection for the setup, or absolute positioning of rotary axes, in negative direction	p2652	3620
11	Bit11	Reserved		
12	MdiTrTyp	Transfer type 0 = value acceptance through 0 → 1 edge at MdiEdge 1 signal: continuous setpoint acceptance	P2649	3620
13	Bit13	Reserved		
14	MdiSetup	Direct setpoint input/MDI – setup selection Select MDI mode setup 0 = positioning 1 = setup	p2653	3620
15	MdiStart	MDI / direct setpoint input mode	p2647	3640

Assignment of EPosSTW 2

Bit	Abbr.	Designation	Drive parameter	Function diagram
0	TrkMode	Start follow-up mode	p2655.0	3635
1	SetRefPt	Set reference point	p2596	3612
2	ActRefCam	Activate reference cam	p2612	3612
3	Bit3	Activate fixed stop	<not used>	
4	Bit4	Reserved		
5	JogInc	Jogging: 0 = endless traversing 1 = traverse by parameterized distance	p2591	3610
6	Bit6	Reserved		
7	Bit7	Reserved		
8	RefTyp	Referencing type selection 0 = reference point approach 1 = flying referencing	p2597	3612
9	RefStDi	Reference point approach, start direction 0 = positive start direction 1 = negative start direction	p2604	3612
10	RefInpS	Sets the signal source for the selection of the probe for flying (passive) referencing 0 = probe 1 is activated 1 = probe 2 is activated	p2510	4010
11	RefEdge	Passive referencing: Setting the edge evaluation 0: positive edge 1: negative edge	p2511	4010
12	Bit12	Reserved		
13	Bit13	Reserved		
14	SftLimAct	Activation of the software limit switches	p2582	3630
15	StpCamAct	Activation of the stop cams	p2568	3630

Assignment of STW2

Bit	Abbr.	Designation	Drive parameter	Function diagram
0	DDSBit0	Drive data set, bit 0	p820.0	8565
1	DDSBit1	Drive data set, bit 1	p821.0	8565
2	DDSBit2	Drive data set, bit 2	p822.0	8565
3	DDSBit3	Drive data set, bit 3	p823.0	8565
4	DDSBit4	Drive data set, bit 4	p824.0	8565
5	GlbStart	Global start	<not used>	
6	ResIComp	Reset I-component of speed controller	<not used>	
7	ActPrkAxis	Activate parking axis	p897	
8	TrvFixedStp	Travel to fixed stop	<not used> (p1545.0)	<not used> (8012)
9	GlbTrgCom	Global trigger command	<not used>	
10	Bit10	Reserved		
11	MotSwOver	Motor switchover completed (0->1)	p828.0	8575
12	MsZykBit0	Master sign-of-life, bit 0	<not used>	
13	MsZykBit1	Master sign-of-life, bit 1	<not used>	
14	MsZykBit2	Master sign-of-life, bit 2	<not used>	
15	MsZykBit3	Master sign-of-life, bit 3	<not used>	

Setpoint overview

PZD	Abbr.	Setpoint	Parameter	Function diagram
5	OverrideV	Velocity override	p2646	3630
6+7	Position	Position setpoint	p2642	3620
8+9	Velocity	Velocity setpoint	p2643	3618
10	OverrideA	Acceleration override	p2644	3618
11	OverrideD	Deceleration override	p2645	3618
12	Word12	Reserved		

PZD	Assignment of the process data
PZD1	Status word 1
PZD2	EPosZSW 1
PZD3	EPosZSW 2
PZD4	status word 2
PZD5	MELDW
PZD6	Position actual value [LU]
PZD7	
PZD8	Velocity actual value (refers to the reference speed p2000)
PZD9	Note: 40000000HEX = 100%
PZD10	Fault (transfer of the active fault number)
PZD11	Alarm (transfer of the active alarm number)
PZD12	Reserved

Assignment of status word 1

Bit	Abbr.	Designation	Drive parameter	Function chart
0	RTS	Ready to start	r899.0	2503
1	RDY	Ready to operate	r899.1	2503
2	IOp	Drive is switched on (condition for the mode selection of the EPos)	r899.2	2503
3	Fault	Fault active	r2139.3	2548
4	NoOff2Act	OFF2 not activated (partial condition for switching on)	r899.4	2503
5	NoOff3Act	OFF3 not activated (partial condition for switching on)	r899.5	2503
6	PowInhbt	Switching on inhibited active	r899.6	2503
7	Alarm	Alarm/warning active	r2139.7	2548
8	NoFlwErr	Following error within tolerance	r2684.8	4025
9	LbCr	Control requested	r899.9	2503
10	TargPos	Target position reached	r2684.10	4020
11	RefPSet	Reference point set	r2684.11	3614
12	TrvTskAck	Acknowledgment, traversing block activated	r2684.12	3646
Important hint according Bit 13, Note: Information is depending on SINAMICS firmware version:				
13	StndStill	SINAMICS S/G120 FW ≥ 4.8 / ≥ 4.7.9, V90 PM: transmission of parameter r2683.2 n_act < speed threshold value 3 [p2161] This bit is used for the standstill detection	r2683.2	2537
13	StndStill	SINAMICS S/G120 FW <4.8 / <4.7.9: transmission of parameter r2199.0 n_act < speed threshold value 3 [p2161] This bit is used for the standstill detection	r2199.0	2537
14	Accel	Axis accelerates	r2684.4	3635
15	Decel	Axis decelerates	r2684.5	3635

Assignment of EPosZSW 1

Bit	Abbr.	Designation	Drive parameter	Function chart
0	ActTrvBit0	Active traversing block, bit 0	r2670.0	3650
1	ActTrvBit1	Active traversing block, bit 1	r2670.1	3650
2	ActTrvBit2	Active traversing block, bit 2	r2670.2	3650
3	ActTrvBit3	Active traversing block, bit 3	r2670.3	3650
4	ActTrvBit4	Active traversing block, bit 4	r2670.4	3650
5	ActTrvBit5	Active traversing block, bit 5	r2670.5	3650
6	Bit6	Reserved		
7	Bit7	Reserved		
8	StpCamMinAct	STOP cam minus active	r2684.13	3630
9	StpCamPlsAct	STOP cam plus active	r2684.14	3630
10	JogAct	Jog mode is active	r2094.0 ¹⁾	2460
11	RefAct	Reference point approach mode active	r2094.1 ¹⁾	2460
12	FlyRefAct	Flying referencing active	r2684.1	3630
13	TrvBlAct	Traversing blocks mode active	r2094.2 ¹⁾	2460
14	MdiStupAct	In the direct setpoint input / MDI mode, setup is active	r2094.4 ¹⁾	2460
15	MdiPosAct	In the direct setpoint input / MDI mode, positioning is active	r2094.3 ¹⁾	2460

¹⁾ r2669 (function diagram 3630) displayed bit-granular. P2099[0] = r2699 is interconnected at the input of the connector-binector converter for this purpose.

Assignment of EPosZSW 2

Bit	Abbr.	Designation	Drive parameter	Function chart
0	TrkModeAct	Follow-up/tracking mode active	r2683.0	3645
1	VeloLimAct	Velocity limitation active	r2683.1	3645
2	SetPStat	Setpoint static	r2683.2	3645
3	PrntMrkOut	Print mark outside outer window	r2684.3	3614
4	FWD	Axis moves forward	r2683.4	3635
5	BWD	Axis moves backward	r2683.5	3635
6	SftSwMinAct	Minus software limit switch actuated	r2683.6	3635
7	SftSwPlsAct	Plus software limit switch actuated	r2683.7	3635
8	PosSmCam1	Position actual value <= cam switching position 1	r2683.8	4025
9	PosSmCam2	Position actual value <= cam switching position 2	r2683.9	4025
10	TrvOut1	Direct output 1 via the traversing block	r2683.10	3616
11	TrvOut2	Direct output 2 via the traversing block	r2683.11	3616
12	FxStpRd	Fixed stop reached	<not used> (r2683.12)	3645
13	FxStpTrRd	Fixed stop clamping torque reached	<not used> (r2683.13)	3645
14	TrvFxStpAct	Travel to fixed stop active	<not used> (r2683.14)	3645
15	CmdAct	Traversing active	r2683.15	3645

Assignment of status word 2

Bit	Abbr.	Designation	Drive parameter	Function chart
0	ActDDSBit0	Drive data set, bit 0	r51.0	8565
1	ActDDSBit1	Drive data set, bit 1	r51.1	8565
2	ActDDSBit2	Drive data set, bit 2	r51.2	8565
3	ActDDSBit3	Drive data set, bit 3	r51.3	8565
4	ActDDSBit4	Drive data set, bit 4	r51.4	8565
5	CmdActRelBrk	Open holding brake active	<not used>	
6	TrqContMode	Torque-controlled operation	<not used>	
7	ParkAxisAct	Parking axis selected	r896.0	
8	Bit8	Reserved	r1406.8	
9	GlbTrgReq	Global trigger request	<not used>	
10	PulsEn	Pulses enabled	r899.11	2503
11	MotSwOverAct	Motor data set switchover active	r835.0	8575
12	SlvZykBit0	Slave sign-of-life, bit 0	<not used>	
13	SlvZykBit1	Slave sign-of-life, bit 1	<not used>	
14	SlvZykBit2	Slave sign-of-life, bit 2	<not used>	
15	SlvZykBit3	Slave sign-of-life, bit 3	<not used>	

Actual value overview

PZD	Abbr.	Actual value	Parameter	Function diagram
5	Word6	Reserved		
6+7	Position	Position actual value	r2521	4010
8+9	Velocity	Velocity actual value	r63	4715
10	ErrNr	Error	r2131	8060
11	WarnNr	Alarm	r2132	8065
12	Reserved	Reserved		

12.2 Standard telegram 1

Table 12-1

S7 bit display (drive)	Meaning
STW1 1.0 (bit 0)	OFF1/ON (pulse enable possible)
STW1 1.1 (bit 1)	OFF2/ON (enable possible)
STW1 1.2 (bit 2)	OFF3/ON (enable possible)
STW1 1.3 (bit 3)	Enable or disable operation
STW1 1.4 (bit 4)	Enable ramp-function generator
STW1 1.5 (bit 5)	Continue ramp-function generator
STW1 1.6 (bit 6)	Enable speed setpoint
STW1 1.7 (bit 7)	Acknowledge fault
STW1 0.0 (bit 8)	Reserved
STW1 0.1 (bit 9)	Reserved
STW1 0.2 (bit 10)	Master control by PLC
STW1 0.3 (bit 11)	Direction of rotation
STW1 0.4 (bit 12)	Unconditionally open holding brake
STW1 0.5 (bit 13)	Motorized potentiometer, increase setpoint
STW1 0.6 (bit 14)	Motorized potentiometer, decrease setpoint
STW1 0.7 (bit 15)	Reserved
STW2 (bits 16 to 32)	Speed setpoint

Table 12-2

S7 bit display (drive)	
ZSW1 1.0 (bit 0)	Ready to start
ZSW1 1.1 (bit 1)	Ready to operate
ZSW1 1.2 (bit 2)	Operation enabled
ZSW1 1.3 (bit 3)	Fault active
ZSW1 1.4 (bit 4)	No coast to stop active (OFF2 active)
ZSW1 1.5 (bit 5)	No coast to stop active (OFF3 inactive)
ZSW1 1.6 (bit 6)	Switching on inhibited active
ZSW1 1.7 (bit 7)	Alarm active
ZSW1 0.0 (bit 8)	Following error within the tolerance range
ZSW1 0.1 (bit 9)	PZD control assumed
ZSW1 0.2 (bit 10)	Target position reached
ZSW1 0.3 (bit 11)	Open holding brake
ZSW1 0.4 (bit 12)	Acknowledgment, traversing block activated
ZSW1 0.5 (bit 13)	No alarm for motor overtemperature
ZSW1 0.6 (bit 14)	Direction of rotation
ZSW1 0.7 (bit 15)	No thermal overload in power unit alarm
ZSW2 (bits 16 to 32)	Bits 16 – 31 → actual speed value

13 References

Table 13-1

	Subject
\1\	Siemens Industry Online Support https://support.industry.siemens.com
\2\	Download page of the article https://support.industry.siemens.com/cs/ww/en/view/109475044
\3\	https://support.industry.siemens.com/cs/ww/de/view/109740020
\4\	https://support.industry.siemens.com/cs/ww/de/view/109475044

13.1 References

This list does not claim to be complete and only provides a selection of suitable references.

Table 13-2

	Topic	Title
/1/	STEP7 SIMATIC S7-300/400	Automation with STEP 7 in STL and SCL Author: Hans Berger Publicis MCD Verlag ISBN: 978-3-89578-397-5
/2/	STEP7 SIMATIC S7-300/400	Automation with STEP 7 in LAD and FBD Author: Hans Berger Publicis MCD Verlag ISBN: 978-3-89578-296-1
/3/	STEP7 SIMATIC S7-300	Automation with SIMATIC S7-300 in the TIA Portal Author: Hans Berger Publicis MCD Verlag ISBN: 978-3-89578-357-9
/4/	STEP7 SIMATIC S7-400	Automation with SIMATIC S7-400 in the TIA Portal Author: Hans Berger Publicis MCD Verlag ISBN: 978-3-89578-372-2
/5/	STEP7 SIMATIC S7-1200	Automation with SIMATIC S7-1200 Author: Hans Berger Publicis MCD Verlag ISBN: ISBN 978-3-89578-355-5
/6/	Basic positioner of the G120	Basic Positioner Function Manual 01/2013, FW V4.6, A5E31759509A AA

13.2 Internet links

This list does not claim to be complete and only provides a selection of suitable information.

Table 13-3

	Topic	Title
\1\	Reference to the article	http://support.automation.siemens.com/WW/view/de/68034568
\2\	Siemens Industry Online Support	http://support.automation.siemens.com
\3\	SINAMICS S120	http://support.automation.siemens.com/WW/view/de/59737625
\4\	LH SINAMICS S120	http://support.automation.siemens.com/WW/view/de/68041075

14 History

Table 14-1

Version	Date	Change
V1.0	06/2013	First edition
V1.1	08/2014	Expanded to include SIMATIC S7-300/400 Description of block SINA_PARA_S (FB287) inserted
V2.0	10/2016	Second edition
V2.1	04/2018	Error correction
V2.2	12/2018	Error correction (Chapt. 5.1.7; Signal AxisSpFixed depending from FW-Version)
V2.3	05/2019	Error correction (Chapt. 12.1; ZSW1; Bit13 depending from FW-Version)
V2.4	07/2019	Error correction (Chapt. 5.6.1; Description of Bit 6 and Bit 7 (ConfigEPos) swapped.