

Catalog  
IC 10

Edition  
2024

SIRIUS

# Industrial Controls

XX  
XX

**Price groups**

PG 41A, 41B

4/2

**Introduction****Contactors for special applications**

- 4/7 SIRIUS 3RT.4 contactors for weak or non-inductive loads (AC-1), 3-pole up to 2 650 A
- 4/21 SIRIUS 3RT.3 contactors, 4-pole, up to 525 A
- 4/36 SIRIUS 3RT25 contactors, 4-pole, 2 NO + 2 NC
- 4/42 SIRIUS 3RT26 contactors for capacitive loads (AC-6b), 3-pole
- 4/52 SIRIUS 3RT23 to 3RT26, 3RT14 contactors
- 4/54 Contactors for railway applications  
- SIRIUS 3RT contactors with extended operating range, 3-pole
- 4/63 - SIRIUS 3RH2 contactor relays with extended operating range
- 4/66 - 3TH4 contactor relays, 8-pole
- 4/68 - 3TC contactors for switching DC voltage, 2-pole
- 4/71 3TC contactors for switching DC voltage, 1- and 2-pole

3/139

**3TG10 power relays/miniature contactors**

# Switching devices – Contactors and contactor assemblies – Special applications

## Introduction

## Overview

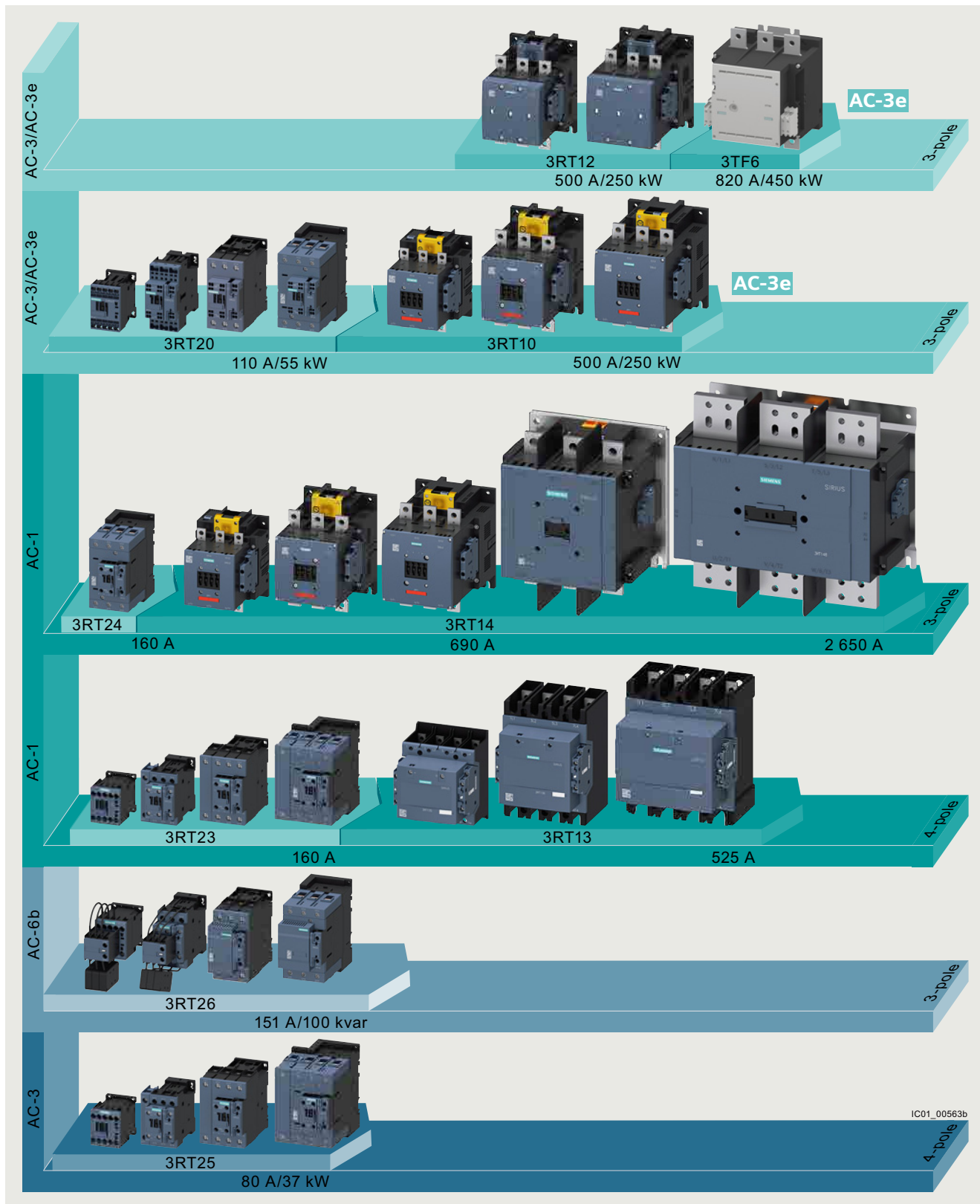

Overview of the 3RT and 3TF contactors

## More information

Homepage, see [www.siemens.com/sirius](http://www.siemens.com/sirius)  
 SiePortal, see [www.siemens.com/product?3RT\\_3TK\\_3TC](http://www.siemens.com/product?3RT_3TK_3TC)

Conversion tool, see [www.siemens.com/conversion-tool](http://www.siemens.com/conversion-tool)  
 TIA Selection Tool Cloud (TST Cloud), see  
[www.siemens.com/tstcloud/?node=Contactor](http://www.siemens.com/tstcloud/?node=Contactor)



Size	<b>S3</b>		<b>S6</b>		<b>S10</b>		<b>S12</b>			
Type	3RT244.		3RT1456		3RT146.		3RT1476			
<b>3-pole 3RT244 and 3RT145 to 3RT147 contactors</b>										
Type	<b>3RT2446</b>		<b>3RT2448</b>		<b>3RT1456</b>		<b>3RT1466 3RT1467</b>		<b>3RT1476</b>	
Number of main contacts	3 NO		3 NO		3 NO		3 NO		3 NO	
AC, AC/DC operation	(p. 4/16)		(p. 4/17, 4/18)		(p. 4/17, 4/18)		(p. 4/17, 4/18)		(p. 4/17, 4/18)	
<b>AC-1</b>										
$U_i$	V	1 000								
$U_e$	V	690								
$I_e$ up to 690 V	40 °C A	<b>140</b>	<b>160</b>	<b>275</b>	<b>400</b>	<b>500</b>	<b>690</b>		Standard operating mechanism: 650, solid-state operating mechanism: 600	
	60 °C A	130	140	250	380	450				

<b>Accessories for contactors</b>								
Auxiliary switches	<b>3RH29, 3RA28</b> (p. 3/91 ... 3/100)			<b>3RH19, 3RT1926</b> (p. 3/94, 3/96, 3/99, 3/101)				
Function modules (direct-on-line starting, star-delta (wye-delta) starting)	<b>3RA28</b> (p. 3/105)			--				
Terminal covers	<b>3RT2946-4EA4</b> (p. 3/118)			<b>3RT1956-4EA.</b> (p. 3/118)				
Box terminal blocks	--			<b>3RT1955-4G, 3RT19.6-4G</b> (p. 3/116)				
Surge suppressors	<b>3RT2936, 3RT2946</b> (p. 3/102, 3/103)			<b>3RT1956-1C</b> (RC element) (p. 3/103)				

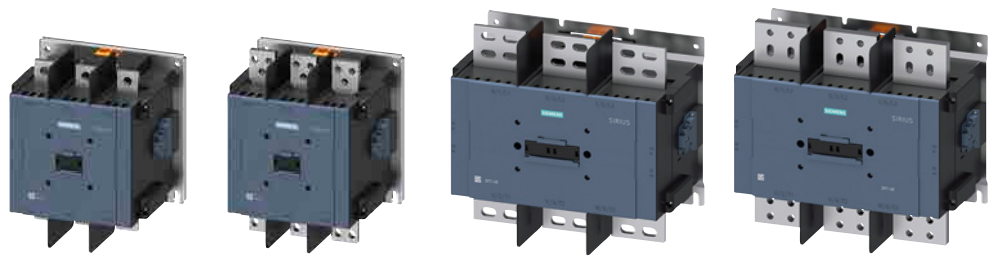

Type	3RT1481, 3RT1482		3RT1483		3RT1485, 3RT1486		3RT1487			
<b>3-pole 3RT148 contactors</b>										
Type	<b>3RT1481</b>		<b>3RT1482</b>		<b>3RT1483</b>		<b>3RT1485 3RT1486</b>		<b>3RT1487</b>	
Number of main contacts	3 NO		3 NO		3 NO		3 NO		3 NO	
AC/DC operation	(p. 4/19)		(p. 4/19)		(p. 4/19)		(p. 4/19)		(p. 4/19)	
<b>AC-1</b>										
$U_i$	V	1 000								
$U_e$	V	1 000								
$I_e$	40 °C A	<b>900</b>	<b>1 050</b>	<b>1 260</b>	<b>1 700</b>	<b>2 100</b>	<b>2 650</b>			
<b>Accessories for contactors</b>										
Second auxiliary switch, lateral	<b>3RH1981-1JA11</b> (p. 4/19)									
<b>Spare parts for contactors</b>										
First auxiliary switch, lateral	<b>3RH1981-1DA11</b> (p. 4/20)									
Phase barriers	<b>3RT1983-4AA1</b> (p. 4/20)			<b>3RT1987-4AA1</b> (p. 4/20)						
Withdrawable coils	<b>3RT1982-5A.31</b> (p. 4/20)		<b>3RT1983-5AP31</b> (p. 4/20)		<b>3RT1987-5AP31</b> (p. 4/20)					



## Switching devices – Contactors and contactor assemblies – Special applications

## Introduction

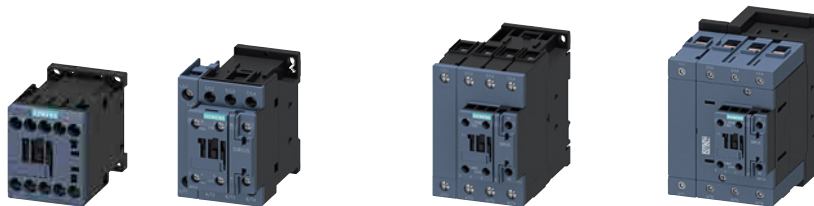

Size	<b>S00</b>		<b>S0</b>			<b>S2</b>		<b>S3</b>			
Type	3RT231.		3RT232.			3RT233.		3RT234.			
<b>4-pole 3RT23 contactors</b>											
Type	<b>3RT2316 3RT2317</b>		<b>3RT2325 3RT2326 3RT2327</b>			<b>3RT2336 3RT2337</b>		<b>3RT2344 3RT2346 3RT2348</b>			
Number of main contacts	4 NO		4 NO			4 NO		4 NO			
AC, DC and AC/DC operation	(p. 4/29, 4/31)		(p. 4/29 ... 4/31)			(p. 4/29 ... 4/33)		(p. 4/29 ... 4/33)			
<b>AC-1</b>											
$U_i$	V	690									
$U_e$	V	690									
$I_e$ up to 690 V	40 °C A	<b>18</b>	<b>22</b>	<b>35</b>	<b>40</b>	<b>50</b>	<b>60</b>	<b>110</b>	<b>110</b>	<b>140</b>	<b>160</b>
	60 °C A	16	20	30	35	42	55	95	100	130	140
<b>AC-3</b>											
$I_e$ up to 400 V	A	9	12	15.5	15.5	15.5	--	--	--	--	--
P at 400 V	kW	4	5.5	7.5	7.5	7.5	--	--	--	--	--
<b>Accessories for contactors</b>											
Auxiliary switches	<b>3RH29, 3RA28</b>								(p. 3/91 ... 3/100)		
Function modules (direct-on-line starting, star-delta (wye-delta) starting)	<b>3RA28</b>								(p. 3/105)		
Terminal covers	--					<b>3RT2936-4EA4</b> (p. 3/118)		<b>3RT2946-4EA4</b>		(p. 3/118)	
Surge suppressors	<b>3RT2916</b>			(p. 3/102, 3/103)		<b>3RT2936</b> (p. 3/102, 3/103)		<b>3RT2936, 3RT2946</b> (p. 3/102, 3/105)			



Size	<b>S6</b>		<b>S10</b>			<b>S12</b>			
Type	3RT1355		3RT136.			3RT137.			
<b>4-pole 3RT13 contactors</b>									
Type	<b>3RT1355</b>		<b>3RT1363 3RT1364</b>		<b>3RT1373 3RT1374 3RT1375</b>				
Number of main contacts	4 NO		4 NO		4 NO				
AC/DC operation	(p. 4/34)		(p. 4/34)		(p. 4/34)				
<b>AC-1</b>									
$U_i$	V	1 000							
$U_e$	V	690		1 000					
$I_e$	40 °C A	200	275	350	400	500	525		
<b>Accessories for contactors</b>									
Second auxiliary switch, lateral	<b>3RH1951-1SA11</b>							(p. 4/35)	
Terminal covers	<b>3RT1956-4EB10</b> (p. 4/35)		<b>3RT1966-4EB10</b> (p. 4/35)		<b>3RT1976-4EB10</b>		(p. 4/35)		
Mechanical interlocks	<b>3RA1954-3A</b>							(p. 4/35)	
Bus connectors offset	--			<b>3RT1966-4D</b> (p. 4/35)		<b>3RT1976-4D</b>		(p. 4/35)	
<b>Spare parts for contactors</b>									
First auxiliary switch, lateral	<b>3RH1951-1TA11</b>							(p. 4/35)	



Size	<b>S00</b>				<b>S0</b>		<b>S2</b>		<b>S3</b>	
Type	3RT251.				3RT252.		3RT253.		3RT254.	
<b>4-pole 3RT25 contactors</b>										
Type	<b>3RT2516 3RT2517 3RT2518</b>				<b>3RT2526</b>		<b>3RT2535 3RT2536</b>		<b>3RT2544 3RT2545</b>	
Number of main contacts	2 NO + 2 NC				2 NO + 2 NC		2 NO + 2 NC		2 NO + 2 NC	
AC, DC and AC/DC operation	(p. 4/39, 4/40)				(p. 4/39, 4/40)		(p. 4/39, 4/41)		(p. 4/39, 4/41)	
<b>AC-1</b>										
$U_i$	V	690								
$U_e$	V	690								
$I_e$ up to 690 V	40 °C	A	18	22	22	40	60	70	100	125
	60 °C	A	16	20	20	35	55	60	90	105
<b>AC-3</b>										
$I_e$ up to 400 V	NO	A	9	12	16	25	35	41	65	80
	NC	A	9	9	9	25 (20) <sup>1)</sup>	35	41	65	80
$P$ at 400 V	NO	kW	4	5.5	7.5	11	18.5	22	30	37
	NC	kW	4	4	4	11 (7.5) <sup>1)</sup>	18.5	22	30	37
at 230 V	NO	kW	2.2	3/2.2	4/2.2	5.5	11	11	18.5	22
	NC	kW	2.2	3/2.2	4/2.2	5.5	11	11	18.5	22
<b>Accessories for contactors</b>										
Auxiliary switches	3RH29, 3RA28									(p. 3/91 ... 3/100)
Function modules (direct-on-line starting, star-delta (wye-delta) starting)	3RA28									(p. 3/105)
Terminal covers	--						3RT2936-4EA4 (p. 3/118)		3RT2946-4EA4 (p. 3/118)	
Surge suppressors	3RT2916 (p. 3/102, 3/103)				3RT2926 (p. 3/102, 3/103)		3RT2936 (p. 3/102, 3/103)		3RT2936, 3RT2946 (p. 3/102, 3/103)	

<sup>1)</sup> The value in brackets applies to the NC for DC operation.

#### Further contactors

- SIRIUS 3RT26 contactors for capacitive loads (AC-6b), 3-pole, [see page 4/42 onwards](#)
- 3TC contactors for switching DC voltage, 1-pole and 2-pole, [see page 4/71 onwards](#)
- Contactors for railway applications
  - SIRIUS 3RT contactors with extended operating range, 3-pole, [see page 4/54 onwards](#)
  - SIRIUS 3RH2 contactor relays with extended operating range, [see page 4/63](#)
  - 3TH4 contactor relays, 8-pole, [see page 4/66 onwards](#)

## Switching devices – Contactors and contactor assemblies – Special applications

### Introduction

#### Connection methods

The following connection options are available for 3RT contactors depending on the size and version:

- 3RT2 contactors
  - Sizes S00 and S0: screw terminals or spring-loaded terminals both for the main as well as for the auxiliary and control circuits
  - Sizes S2 and S3: screw terminals (complete devices) or spring-loaded terminals (auxiliary circuit only)
- 3RT13 contactors, sizes S6 to S12: Busbar connections (partly with bus connectors offset), auxiliary and control circuits with screw terminals
- 3RT14 contactors: Busbar connections



Screw terminals



Spring-loaded terminals



Busbar connections

The connection method is indicated in the corresponding tables by the symbols shown on orange backgrounds.

#### Voltage data

The data for 3-phase power systems according to IEC 60947-4-1 are valid for the following line system configurations:

Voltage $U_e$	Line system configurations	
	Three-phase four-wire systems	Three-phase three-wire systems
V	V	V
230	--	230
400	230/400	400
440	260/440	440
500	--	500
690	400/690	690 (only from size S3)
1 000	--	1 000

-- Not specified

## Switching devices – Contactors and contactor assemblies – Special applications

### Contactors for special applications

#### SIRIUS 3RT.4 contactors for weak or non-inductive loads (AC-1), 3-pole up to 2 650 A

#### Overview



3-pole AC-1 contactors  
top row: 3RT148 contactors  
bottom row: 3RT244, 3RT145 to 3RT147 contactors

#### Standards

IEC 60947-1, IEC 60947-4-1, IEC 60947-5-1 (auxiliary switches)

#### Contactors with increased tamper protection

Increased tamper protection is ensured either by using our contactor versions with factory-installed, permanently mounted auxiliary switches which are protected against mechanical external actuation (e.g. 3RT14...-...-3PA0 contactors), or by using the 3RT1926-4MA10 sealable cover as an accessory, (see page 3/118).

#### Protecting connections against short circuit, overload and overvoltage

All connections must generally be protected against overload and short circuits using suitable measures. Different constraints must be considered depending on the type of connection:

##### Short-circuit and overload protection of main connections

For information on the protection of a free-standing contactor, see the [technical product data sheet](#).

For more information on device combinations such as contactor with overload relay or contactor with circuit breaker as motor feeder, refer to

- [Digital Configuration Manual for load feeders](#)
- [Configuration Manual for load feeders](#)

##### Short-circuit and overload protection of auxiliary connections

For information on the protection of auxiliary contacts, see the [technical product data sheet](#).

##### Short-circuit and overload protection of control supply voltage or supply voltage connections

First of all, the relevant standards and regulations for configuring control panels and the parts and components installed in them must be taken into account, for example for cable dimensioning.

One possible protection for these circuits could be the selection of a suitable power supply, i.e. one with a current-limiting function. In the selection of the source and the connecting cable, the load characteristics of the contactor must be considered

(short-time inrush current peaks for solid-state contactor operating mechanisms, switch-on power, holding power). The same applies to the selection of suitable protection devices.

If there are further switching elements in the circuit, such as the auxiliary contact system of an overload relay that operates the contactor, the short-circuit protection necessary for this must also be considered.

For further recommendations, e.g. the use of miniature circuit breakers or circuit breakers for equipment in control circuits, see [Control panel tip – Selecting and dimensioning suitable power supplies quickly and reliably](#).

##### Short-circuit and overload protection of contactors with digital input

A typical rated current of 20 mA applies to these inputs based on the PLC input types according to IEC 60947-4-1. The inputs can be protected accordingly.

- Contactors with PLC and F-PLC inputs:
  - For 3RT14...-S and 3RT14...-N, marked with +/-
- Supply voltage connections A1 - A2:
  - For 3RT14...-N, protection based on the load characteristics must be employed. For information on power consumption, see the [technical product data sheet](#).
  - For 3RT14...-S, protection is already integrated.

##### Short-circuit and overload protection of other connections

The 3RT14...-P contactor version with remaining lifetime indicator (RLT) also has additional connections H1 - H2 and R1 - R2.

If A1 - A2 is already protected, further protection of H1 - H2 is not required.

For protection specifications for protecting R1 - R2, see the [technical product data sheet](#).



## Switching devices – Contactors and contactor assemblies – Special applications

### Contactors for special applications

#### SIRIUS 3RT.4 contactors for weak or non-inductive loads (AC-1), 3-pole up to 2 650 A

##### Protection against overvoltage at the control supply voltage connection

3RT244 contactors supplied without a coil circuit can be retrofitted with RC elements, varistors, diodes or diode assemblies (combination of diode and Zener diode for short break times) for damping switching overvoltages in the coil and can be ordered separately as accessories, [see page 3/102 onwards](#).

3RT14 contactors are already equipped with coil damping (varistor).

##### Note:

The break times of the contactor, the opening delay times of the NO contacts and the closing delay times of the NC contacts increase in the event of damping.

For more information about influencing the time response using damping, [see Equipment Manual](#).

#### **Connection methods**

##### Main circuit

- 3RT244 contactors:  
Screw terminals with box terminal;  
direct connection to the connecting bar possible with cable lugs when the box terminal is removed.
- 3RT145 to 3RT147 contactors:  
Screw terminals with connecting bars that the cables can be connected to using either cable lugs or flexible or rigid busbars. Alternatively, box terminals are available as accessories.
- 3RT148 contactors:  
Screw terminals with connecting bars

##### Auxiliary and control circuits

- 3RT24, 3RT145 to 3RT147:  
Screw or spring-loaded terminals
- 3RT148:  
Screw terminals

#### **Electromagnetic compatibility (EMC)**

The contactors comply with the conditions for environment A according to IEC 60947-1.

##### Note:

When the contactors are used in an environment with frequency converters, the configuration notes must be observed, [see Equipment Manual](#).

#### **Contact reliability of the auxiliary contacts**

If voltages  $\leq 110$  V and currents  $\leq 100$  mA are to be switched, the auxiliary contacts of the 3RT contactors or 3RH contactor relays should be used as they guarantee a high level of contact reliability.

These auxiliary contacts are particularly suitable for solid-state circuits with currents  $\geq 1$  mA at a voltage  $\geq 17$  V.

#### **Operating mechanism types**

##### 3RT244 contactors

The contactors are available as versions with conventional AC or DC operating mechanisms or as versions with a wide-range solid-state operating mechanism and a universal actuating voltage (AC or DC operation).

With an operating range from 0.8 to  $1.1 \times U_s$ , control takes place via the control supply voltage connection A1 - A2.

##### 3RT145 to 3RT147 contactors

The contactors are powered via a supply voltage with an operating range from 0.8 to  $1.1 \times U_s$ , optionally also controlled depending on the chosen mode of operation. Alternatively, control is via the separate 24 V DC control signal input. Various rated voltage ranges for AC/DC control are available.

The following control and/or operating mechanism versions are available:

- 3RT14...-A contactors:  
Standard operating mechanism for AC and DC operation (power consumption reduced from closing to closed)
- Solid-state operating mechanisms:  
Overvoltage damping of the operating mechanism coil is already integrated in the electronics for contactors with solid-state operating mechanisms.  
The following versions are available:
  - 3RT14...-N contactors:  
With two operating modes: Direct control or via PLC input (24 V DC)
  - 3RT14...-P contactors:  
Control via PLC input (24 V DC) only, but with additional remaining lifetime indicator (RLT)
  - 3RT14...-S contactors:  
Control via fail-safe PLC input (24 V DC) only, for simplification of safety applications

##### 3RT148 contactors

The contactors are equipped with a solid-state operating mechanism for AC/DC control; coil damping is integrated. The operating range is 0.85 ...  $1.1 \times U_s$ .

#### **Replacing solenoid coils, operating mechanisms or spare contacts**

##### 3RT244 contactors

Solenoid coil or spare contact replacement is possible.

##### 3RT145 to 3RT147 contactors

The operating mechanisms for 3RT14...-A/-N/-P contactors are removable and can be replaced simply by unlocking and pulling them out. The spare contacts can also be replaced.

##### NOTICE:

Removal or changing of the operating mechanism is not permitted for 3RT14...-S contactors with fail-safe control.

##### 3RT148 contactors

The operating mechanisms are removable and can be replaced simply by unlocking and pulling them out.

#### **Fitting auxiliary contacts and mounting additional auxiliary switches**

##### Features in the delivery state

- 3RT244 contactors:  
Two auxiliary contacts (1 NO + 1 NC) are integrated in the basic unit.
- 3RT14 contactors:  
These contactors are supplied with two laterally mounted auxiliary switches with two contacts each (2 NO + 2 NC).

##### Expansion possibilities

All basic units can be expanded using auxiliary switches; the permissible configuration must be observed.

For detailed information about the fitting of auxiliary switches for 3RT244 contactors, [see pages 3/83 to 3/90](#).

#### **Accessories and spare parts**

- 3RT244 and 3RT145 to 3RT147 contactors, [see Basic units, page 3/71 onwards](#)
- 3RT148 contactors, [see page 4/19 onwards](#)

## Switching devices – Contactors and contactor assemblies – Special applications

### Contactors for special applications

#### SIRIUS 3RT.4 contactors for weak or non-inductive loads (AC-1), 3-pole up to 2 650 A

##### Connection of contactors to fail-safe control modules

While contactors with smaller power ratings can be connected directly to the outputs of fail-safe controllers, implementing safety-related applications with standard contactors with higher power is much more complicated and elaborate because of the necessary coupling links.

Due to their fail-safe control input, the special versions from sizes S6 to S12 (3RT14...S) provide a much simpler way of doing this.

For more information, see

- Safety technology, page 11/1 onwards
- Guide of use for contactors in safety applications

Example for SIL 2 and SIL 3/PL e application – previously:

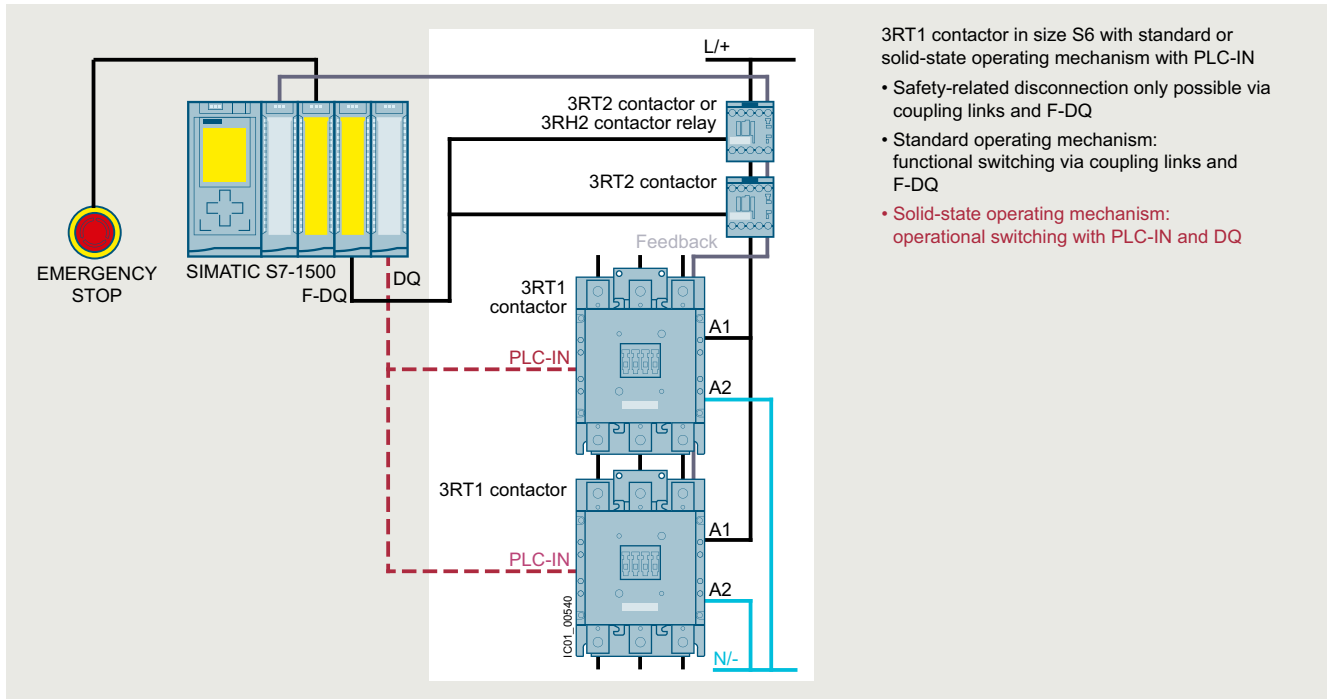

Application with safety-related disconnection with standard contactors using the example of a 3RT145 contactor

Example for SIL 3/PL e (left-hand side) and SIL 2/PL c (right-hand side) application – new:

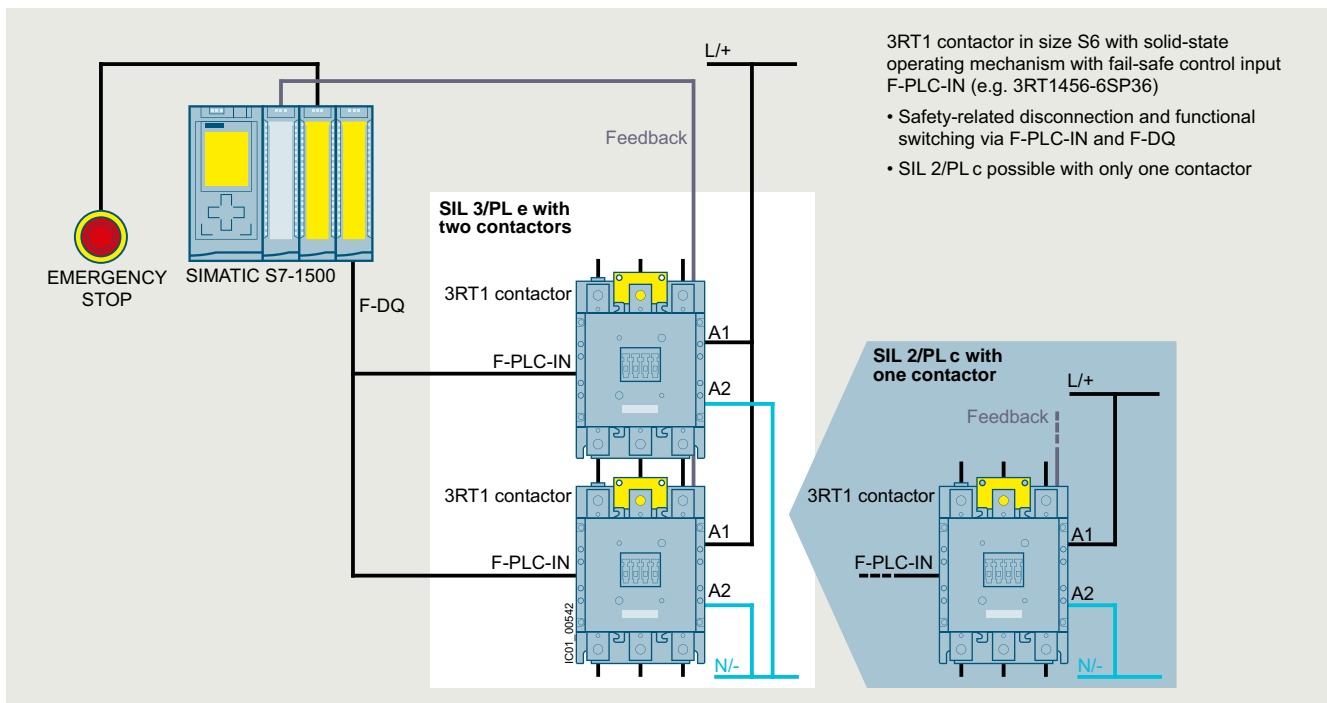

Application with safety-related disconnection with contactors with fail-safe control using the example of a 3RT145 contactor

## Switching devices – Contactors and contactor assemblies – Special applications

### Contactors for special applications

#### SIRIUS 3RT.4 contactors for weak or non-inductive loads (AC-1), 3-pole up to 2 650 A

##### Overview graphics with mountable accessories

- 3RT244 contactors, [see page 3/11](#)
- 3RT145 to 3RT147 contactors, [see page 3/12 onwards](#)
- 3RT148 contactors, [see following graphic](#)

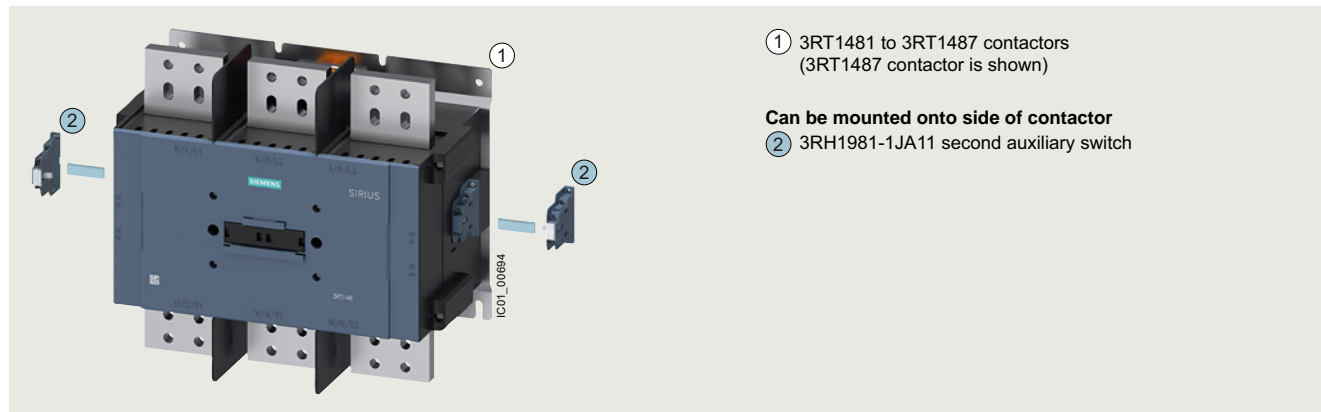

3RT1481 to 3RT1487 contactors with mountable accessories

#### Application

The 3RT.4 contactors can be used for the following applications:

- For switching weak or non-inductive loads (AC-1)
- Disconnecting loads or power generation plants from the grid (e.g. wind turbines or photovoltaic systems)
- Disconnecting frequency converters from the grid

# Switching devices – Contactors and contactor assemblies – Special applications

## Contactors for special applications



### SIRIUS 3RT.4 contactors for weak or non-inductive loads (AC-1), 3-pole up to 2 650 A

#### Technical specifications

##### More information

Technical specifications, see  
<https://support.industry.siemens.com/cs/ww/en/ps/24229/td>  
 For FAQs, see <https://support.industry.siemens.com/cs/ww/en/ps/24229/faq>

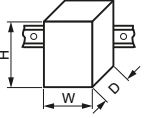
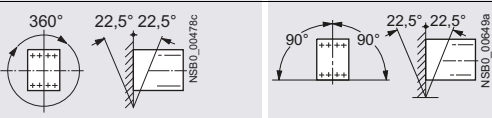
Manuals, see  
<https://support.industry.siemens.com/cs/ww/en/ps/24229/man>  
 Guide of use for contactors in safety applications, see  
<https://support.industry.siemens.com/cs/ww/en/view/109807687>

Type	3RT2446, 3RT2448	3RT1456	3RT1466	3RT1467	3RT1476
Size	S3	S6	S10	S12	S12
<b>General data</b>					
<b>Dimensions (W x H x D)</b>					
<ul style="list-style-type: none"> <li>Basic units               <ul style="list-style-type: none"> <li>Screw/spring-loaded terminals</li> </ul> </li> <li>Basic unit with mounted auxiliary switch               <ul style="list-style-type: none"> <li>Screw terminals</li> <li>Spring-loaded terminals</li> </ul> </li> <li>Basic unit with mounted function module or solid-state time-delay auxiliary switch               <ul style="list-style-type: none"> <li>Screw/spring-loaded terminals</li> </ul> </li> </ul>		mm	70 x 140 x 152	120 x 172 x 170   145 x 210 x 202	160 x 214 x 225
		mm	70 x 140 x 196 70 x 140 x 200	120 x 172 x 217   145 x 210 x 251	160 x 214 x 271
		mm	70 x 140 x 226	--	--
<b>Permissible mounting position</b>					
The contactors are designed for operation on a vertical mounting surface.					
Upright mounting position			 Special version required		
<b>Mechanical endurance</b>					
<ul style="list-style-type: none"> <li>Basic units and basic units with mounted auxiliary switch</li> </ul>	Operating cycles	10 million			
<ul style="list-style-type: none"> <li>Basic units with solid-state-compatible auxiliary switch</li> </ul>	Operating cycles	5 million	--		
<b>Electrical endurance for utilization category AC-1, at <math>U_e = 400\text{ V}</math></b>					
Operating cycles	0.5 million			0.35 million	0.5 million
<b>Rated insulation voltage <math>U_i</math></b> (pollution degree 3)					
V	1 000				
<b>Rated impulse withstand voltage <math>U_{imp}</math></b>					
kV	6	8			
<b>Protective separation</b> between the coil and the main contacts according to IEC 60947-1, Annex N					
V	690				
<b>Mirror contacts</b> according to IEC 60947-4-1, Annex F					
A mirror contact is an auxiliary NC contact that cannot be closed simultaneously with an NO main contact.					
<ul style="list-style-type: none"> <li>Integrated auxiliary switches</li> <li>Removable auxiliary switches</li> </ul>	Yes --	-- Yes			
<b>Permissible ambient temperature</b>					
<ul style="list-style-type: none"> <li>During operation</li> <li>During storage</li> </ul>	°C °C	-25 ... +60 -55 ... +80			
<b>Short-circuit protection</b>					
<b>Main circuit</b>					
<ul style="list-style-type: none"> <li>Version of the fuse link required for short-circuit protection of the main circuit               <ul style="list-style-type: none"> <li>For type of coordination 1</li> <li>For type of coordination 2</li> </ul> </li> </ul>		gG: 250 A (690 V, 100 kA) gG: 250 A (690 V, 100 kA)	gG: 355 A (690 V, 100 kA) gG: 350 A (690 V, 100 kA)	gG: 500 A (690 V, 100 kA) gG: 500 A (690 V, 100 kA)	gG: 800 A (690 V, 50 kA) gG: 710 A (690 V, 100 kA)
<b>Auxiliary circuit</b>					
<ul style="list-style-type: none"> <li>Version of the fuse link required for short-circuit protection of the auxiliary switch</li> <li>Version of the miniature circuit breaker required for short-circuit protection of the auxiliary switch</li> </ul>	A A	Fuse gG: 10 On request			
Short-circuit protection for contactors with overload relays					
See <ul style="list-style-type: none"> <li>Digital Configuration Manual for load feeders</li> <li>Configuration Manual for load feeders</li> </ul>					
Short-circuit protection for fuseless load feeders					
See <ul style="list-style-type: none"> <li>3RA2 load feeders, page 8/5 onwards</li> <li>Digital Configuration Manual for load feeders</li> <li>Configuration Manual for load feeders</li> </ul>					

# Switching devices – Contactors and contactor assemblies – Special applications

## Contactors for special applications

### SIRIUS 3RT.4 contactors for weak or non-inductive loads (AC-1), 3-pole up to 2 650 A

Type	3RT2446, 3RT2448		3RT1456		3RT1466, 3RT1467		3RT1476				
Size	S3		S6		S10		S12				
<b>Control</b>											
<b>Solenoid coil operating range (AC/DC)</b>											
0.8 ... 1.1 x $U_s$   0.8 x $U_{s \text{ min}}$ ... 1.1 x $U_{s \text{ max}}$											
<b>Power consumption of the solenoid coils</b> (for cold coil and 1.0 x $U_s$ )											
<ul style="list-style-type: none"> <li>AC operation, 50 Hz, standard version</li> <li>AC operation, 50/60 Hz, standard version</li> <li>AC operation, 50/60 Hz, for USA/Canada</li> <li>AC/DC operation</li> </ul>	Closing	VA	296	--							
			P.f.	0.61	--						
	Closed	VA	19	--							
			P.f.	0.38	--						
	Closing	VA	348/296	--							
			P.f.	0.62/0.55	--						
			Closed	25/18	--						
	Closing	VA	326/326	--							
			P.f.	0.62/0.55	--						
			Closed	22/22	--						
	Closing for AC operation	VA	--	163	300	280	590	530	830	750	
			P.f.	--	3.1	0.9	0.8	0.9	0.8	0.9	0.8
			Closed for AC operation	VA	--	76	360	320	650	580	920
	Closing for DC operation	W	--	1.8	5.2	2.8	7.4	3.4	10	3.6	
			P.f.	--		0.8	0.6	0.9	0.4	0.9	0.4
			Closed for DC operation	W	--						
<b>Type of PLC control input according to IEC 60947-1</b>											
<ul style="list-style-type: none"> <li>Solid-state operating mechanism</li> <li>Rated voltage</li> <li>Operating range</li> <li>Power consumption</li> <li>Recovery time after power failure, typical (applicable only for fail-safe version 3RT14...S)</li> </ul>	3RT14...-N/-P	V DC	--	Type 2							
			3RT14...-S	--	Type 1						
	V DC	--	24								
		V DC	--	17 ... 30							
	mA	--	≤ 30								
s	--	2									
<b>Rated data of the main contacts</b>											
<b>Load rating with AC</b>											
<b>Utilization category AC-1</b>											
<ul style="list-style-type: none"> <li>Rated operational currents <math>I_e</math></li> <li>Minimum cross-section in the main circuit at maximum AC-1 rated value</li> </ul>	At 40 °C up to 690 V A	A	140	160	275	400	500	690			
			At 60 °C up to 690 V A	130	140	250	380	450	Standard operating mechanism: 650, solid-state operating mechanism: 600		
	mm <sup>2</sup>	At 40 °C up to 1 000 V A	60	80	--						
		At 60 °C up to 1 000 V A	60	80	--						
<b>Power loss per main conducting path</b>			At $I_e$ /AC-1/40 °C W	9.8	12.8	28.8	35.2	35.2	61.9		
<b>Conductor cross-sections</b>											
<b>Main conductors</b> (1 or 2 conductors can be connected)											
<b>Screw terminals</b>											
<ul style="list-style-type: none"> <li>Solid</li> <li>Stranded</li> <li>Finely stranded with end sleeve (DIN 46228)</li> <li>AWG cables, solid or stranded</li> <li>Terminal screws</li> <li>Tightening torque</li> </ul>	mm <sup>2</sup>	2 x (2.5 ... 16) <sup>1)</sup>									
	mm <sup>2</sup>	2 x (6 ... 16) <sup>1)</sup> ; 2 x (10 ... 50) <sup>1)</sup> ; 1 x (10 ... 70) <sup>1)</sup>									
	mm <sup>2</sup>	2 x (2.5 ... 35) <sup>1)</sup> ; 1 x (2.5 ... 50) <sup>1)</sup>									
	AWG	2 x (10 ... 1/0) <sup>1)</sup> ; 1 x (10 ... 2/0) <sup>1)</sup>									
	Nm	Hexagon socket, size 4 4.5 ... 6 (40 ... 53 lb.in)									
<b>Auxiliary conductors and control conductors</b> (1 or 2 conductors can be connected)											
<ul style="list-style-type: none"> <li>Solid or stranded</li> <li>Finely stranded with end sleeve (DIN 46228)</li> <li>AWG cables, solid or stranded</li> <li>Terminal screws</li> <li>Tightening torque</li> </ul>	mm <sup>2</sup>	2 x (0.5 ... 1.5) <sup>1)</sup> ; 2 x (0.75 ... 2.5) <sup>1)</sup>									
	mm <sup>2</sup>	2 x (0.5 ... 1.5) <sup>1)</sup> ; 2 x (0.75 ... 2.5) <sup>1)</sup>									
	AWG	2 x (20 ... 16) <sup>1)</sup> ; 2 x (18 ... 14) <sup>1)</sup>									
	M3 (for Pozidriv size 2; Ø 5 ... 6 mm)	0.8 ... 1.2 (7 ... 10.3 lb.in)									
	Nm										





<sup>1)</sup> If two different conductor cross-sections are connected to one clamping point, both cross-sections must lie in one of the ranges specified.



# Switching devices – Contactors and contactor assemblies – Special applications

## Contactors for special applications

### SIRIUS 3RT.4 contactors for weak or non-inductive loads (AC-1), 3-pole up to 2 650 A

Type	3RT1456		3RT1466, 3RT1467	3RT1476
Size	S6		S10	S12
<b>Conductor cross-sections</b>				
<b>Main conductors</b> (1 or 2 conductors can be connected)				
 <b>Screw terminals</b>				
<b>With mounted box terminals</b>				
Type	3RT1955-4G	3RT1956-4G	3RT1966-4G	
Terminal screws	M10 (hexagon socket, A/F 4)	M10 (hexagon socket, A/F 4)	M12 (hexagon socket, A/F 5)	
• Tightening torque	Nm 10 ... 12 lb.in 90 ... 110	10 ... 12 90 ... 110	20 ... 22 180 ... 195	
<b>Front clamping point connected</b>				
	• Finely stranded with end sleeve (DIN 46228)	mm <sup>2</sup> 16 ... 70	16 ... 120	70 ... 240
	• Finely stranded without end sleeve	mm <sup>2</sup> 16 ... 70	16 ... 120	70 ... 240
	• Stranded	mm <sup>2</sup> 16 ... 70	16 ... 120	95 ... 300
	• AWG cables, solid or stranded	AWG 6 ... 2/0	6 ... 250 kcmil	3/0 ... 600 kcmil
• Ribbon cable conductors (Number x Width x Thickness)	mm Min. 3 x 9 x 0.8, max. 6 x 15.5 x 0.8	Min. 3 x 9 x 0.8, max. 10 x 15.5 x 0.8	Min. 6 x 9 x 0.8, max. 20 x 24 x 0.5	
<b>Rear clamping point connected</b>				
	• Finely stranded with end sleeve (DIN 46228)	mm <sup>2</sup> 16 ... 70	16 ... 120	120 ... 185
	• Finely stranded without end sleeve	mm <sup>2</sup> 16 ... 70	16 ... 120	120 ... 185
	• Stranded	mm <sup>2</sup> 16 ... 70	16 ... 120	120 ... 240
	• AWG cables, solid or stranded	AWG 6 ... 2/0	6 ... 250 kcmil	250 ... 500 kcmil
• Ribbon cable conductors (Number x Width x Thickness)	mm Min. 3 x 9 x 0.8, max. 6 x 15.5 x 0.8	Min. 3 x 9 x 0.8, max. 10 x 15.5 x 0.8	Min. 6 x 9 x 0.8, max. 20 x 24 x 0.5	
<b>Both clamping points connected</b> (minimum cross-section 16 mm <sup>2</sup> )				
	• Finely stranded with end sleeve (DIN 46228)	mm <sup>2</sup> Max. 1 x 50, 1 x 70	Max. 1 x 95, 1 x 120	Min. 2 x 50, max. 2 x 185
	• Finely stranded without end sleeve	mm <sup>2</sup> Max. 1 x 50, 1 x 70	Max. 1 x 95, 1 x 120	Min. 2 x 50, max. 2 x 185
	• Stranded	mm <sup>2</sup> Max. 1 x 50, 1 x 70	Max. 1 x 95, 1 x 120	Min. 2 x 70, max. 2 x 240
	• AWG cables, solid or stranded	AWG Max. 2 x 1/0	Max. 2 x 3/0	Min. 2 x 2/0, max. 2 x 500 kcmil
• Ribbon cable conductors (Number x Width x Thickness)	mm Max. 2 x (6 x 15.5 x 0.8)	Max. 2 x (10 x 15.5 x 0.8)	Max. 2 x (20 x 24 x 0.5)	
<b>Busbar connections</b>				
• Connecting bar (max. width)	mm 17		25	
- Bore diameter	mm 9		11	
<b>Cable lug connection</b>				
1) <span style="margin-left: 100px;">2)</span>				
• Finely stranded with cable lug	mm <sup>2</sup> 16 ... 95		50 ... 240	
• Stranded with cable lug	mm <sup>2</sup> 25 ... 120		70 ... 240	
• AWG cables, solid or stranded	AWG 4 ... 250 kcmil		2/0 ... 500 kcmil	
• Terminal screws	M8 x 25 (A/F 13)		M10 x 30 (A/F 17)	
- Tightening torque	Nm 10 ... 14 lb.in 90 ... 124		14 ... 24 124 ... 210	
<b>Auxiliary conductors</b> (1 or 2 conductors can be connected)				
• Solid	mm <sup>2</sup> 2 x (0.5 ... 1.5) <sup>3)</sup> , 2 x (0.75 ... 2.5) <sup>3)</sup>	according to IEC 60947; max. 2 x (0.75 ... 4) <sup>3)</sup>		
• Finely stranded with end sleeve (DIN 46228)	mm <sup>2</sup> 2 x (0.5 ... 1.5) <sup>3)</sup> ; 2 x (0.75 ... 2.5) <sup>3)</sup>			
• AWG cables, solid or stranded	AWG 2 x (18 ... 14)			
• Terminal screws	M3 (Pozidriv size 2)			
- Tightening torque	Nm 0.8 ... 1.2 lb.in 7 ... 10.3			
<b>Auxiliary conductors<sup>4)</sup></b> (1 or 2 conductors can be connected)				
 <b>Spring-loaded terminals</b>				
• Operating devices		3.0 x 0.5; 3.5 x 0.5		
• Solid	mm <sup>2</sup> 2 x (0.25 ... 2.5)			
• Finely stranded with end sleeve (DIN 46228)	mm <sup>2</sup> 2 x (0.25 ... 1.5)			
• Finely stranded without end sleeve	mm <sup>2</sup> 2 x (0.25 ... 2.5)			
• AWG cables, solid or stranded	AWG 2 x (24 ... 14)			

1) 3RT1456: When connecting cable lugs according to DIN 46235, use the 3RT1956-4EA1 terminal cover for conductor cross-sections from 95 mm<sup>2</sup> to maintain the phase clearance, see page 3/118.

2) 3RT1466, 3RT1467 and 3RT1476: When connecting cable lugs according to DIN 46234 for conductor cross-sections larger than 240 mm<sup>2</sup> and according to DIN 46235 for conductor cross-sections larger than 185 mm<sup>2</sup>, the 3RT1966-4EA1 terminal cover is required to maintain the phase clearance, see page 3/118.

3) If two different conductor cross-sections are connected to one clamping point, both cross-sections must lie in one of the ranges specified.

4) Max. outer diameter of the conductor insulation: 3.6 mm. On spring-loaded terminals with conductor cross-sections ≤ 1 mm<sup>2</sup> an insulation stop is recommended, see page 3/121.

## Switching devices – Contactors and contactor assemblies – Special applications

### Contactors for special applications

#### SIRIUS 3RT.4 contactors for weak or non-inductive loads (AC-1), 3-pole up to 2 650 A

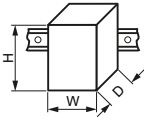
Type		3RT1481-6A.36	3RT1482-6A.36	3RT1483-6AP36	3RT1485-6AP36	3RT1486-6AP36	3RT1487-6AP36	
<b>General data</b>								
<b>Dimensions</b>								
• Width		mm	285			431		
• Height		mm	352			403		
• Depth		mm	250			246		
<b>Mounting position</b>		For vertical mounting surface can be rotated $\pm 30^\circ$ , for vertical mounting surface can be tilted $\pm 30^\circ$ forward or backward						
<b>Installation altitude at height above sea level, maximum</b>		m	2 000					
<b>Insulation voltage at pollution degree 3</b>								
• Of the main circuit		V	1 000					
• Of the auxiliary circuit		V	600					
<b>Impulse withstand voltage</b>								
• Of the main circuit		kV	8					
• Of the auxiliary circuit		kV	6					
<b>Product function, mirror contact according to IEC 60947-4-1</b>		Yes						
<b>Ambient temperature</b>								
• During operation		°C	-25 ... +55					
• During storage		°C	-40 ... +80					
<b>Short-circuit protection</b>								
<b>Version of the fuse link required</b>								
• For short-circuit protection of the main circuit for type of coordination 2			aR: 1 000 A (1 000 V, 30 kA)	aR: 1 100 A (1 000 V, 42 kA)	aR: 1 400 A (1 000 V, 42 kA)	aR: 2 200 A (1 000 V, 42 kA)	aR: 2 500 A (1 000 V, 42 kA)	aR: 2 800 A (1 000 V, 50 kA)
• For short-circuit protection of the auxiliary switch			gG: 16 A (600 V, 1 kA)					

## Switching devices – Contactors and contactor assemblies – Special applications

### Contactors for special applications

#### SIRIUS 3RT.4 contactors for weak or non-inductive loads (AC-1), 3-pole up to 2 650 A

Type		3RT1481- 6AF36	6AP36	3RT1482- 6AF36	6AP36	3RT1483- 6AP36	3RT1485- 6AP36	3RT1486- 6AP36	3RT1487- 6AP36	
<b>Control circuit/control</b>										
<b>Operating range factor of the control supply voltage, rated value of the solenoid coil</b>										
<ul style="list-style-type: none"> <li>At AC at 50 Hz</li> <li>At AC at 60 Hz</li> <li>At DC</li> </ul>		0.85 ... 1.1 0.85 ... 1.1 0.85 ... 1.1								
<b>Solenoid coil closing for DC</b>	W	1 400	2 000	1 400	2 000	2 700	2 800			
<b>Closing apparent power of the solenoid coil for AC</b>										
<ul style="list-style-type: none"> <li>At 50 Hz</li> <li>At 60 Hz</li> </ul>		VA	1 000			1 700	1 800			
		VA	1 000			1 700	1 800			
<b>Solenoid coil closed for DC</b>	W	6	7	6	7	8	11			
<b>Closed apparent power of the solenoid coil for AC</b>										
<ul style="list-style-type: none"> <li>At 50 Hz</li> <li>At 60 Hz</li> </ul>		VA	18	23	18	23	20	33		
		VA	18	23	18	23	20	33		
<b>Main circuit</b>										
<b>Operational current at AC-1</b>										
<ul style="list-style-type: none"> <li>Up to 690 V</li> </ul>										
- At an ambient temperature of 40 °C		A	900	1 050		1 260	1 700	2 100	2 650	
- At an ambient temperature of 55 °C		A	900	1 050		1 260	1 700	2 100	2 650	
<ul style="list-style-type: none"> <li>Up to 1 000 V</li> </ul>										
- At an ambient temperature of 40 °C		A	900	1 050		1 260	1 700	2 100	2 650	
- At an ambient temperature of 55 °C		A	900	1 050		1 260	1 700	2 100	2 650	
<b>Type of electrical connection for the main circuit</b>		Busbar connections								
<b>Minimum cross-section in the main circuit for max. AC-1 rated value</b>		mm <sup>2</sup>	600	800		1 000	1 500	2 000	3 000	
<b>Conductor cross-sections</b>										
<b>Control circuit/control</b>										
<b>Type of connectable conductor cross-sections for auxiliary contacts</b>										
<ul style="list-style-type: none"> <li>Solid</li> </ul>		2x (1 ... 2.5 mm <sup>2</sup> )								
<ul style="list-style-type: none"> <li>Solid or stranded</li> </ul>		2x (1 ... 2.5 mm <sup>2</sup> )								
<ul style="list-style-type: none"> <li>Finely stranded with end sleeve</li> </ul>		2x (1 ... 2.5 mm <sup>2</sup> )								
<b>Main circuit</b>										
<b>Width of connecting bar</b>	mm	40	50		103					
<b>Thickness of connecting bar</b>	mm	10	13		10		20			
<b>Diameter of hole</b>	mm	17	13		15		13			

## Switching devices – Contactors and contactor assemblies – Special applications

### Contactors for special applications

#### SIRIUS 3RT.4 contactors for weak or non-inductive loads (AC-1), 3-pole up to 2 650 A



##### Selection and ordering data

##### Size S3: AC operation or AC/DC operation

- Coil circuits (varistors, diodes, etc.) retrofittable
- Auxiliary switches can be retrofitted
- Main and control conductors: Screw terminals



3RT244.-1...0

Size	Rated data		Auxiliary contacts		Rated control supply voltage $U_s$		Screw terminals 	PU (UNIT, SET, M)	PS*	PG
	AC-1, $t_{ij}$ : 40 °C   60 °C	Operational current $I_e$ up to	Ident. No.	Version	50 Hz AC	50 Hz AC or DC				
<b>690 V</b>	690 V				V	V	Article No.	Price per PU		
<b>A</b>	A		NO	NC	V	V				

##### For screw fixing and snap-on mounting on TH 35-15 and TH 75-15 DIN rails

##### AC operation

<b>S3</b>	<b>140</b>	130	<b>11</b>	1	1	24	--	<b>3RT2446-1AB00</b>	1	1 unit	41B				
						110	--					<b>3RT2446-1AF00</b>	1	1 unit	41B
						230	--					<b>3RT2446-1AP00</b>	1	1 unit	41B
	<b>160</b>	140	<b>11</b>	1	1	24	--	<b>3RT2448-1AB00</b>	1	1 unit	41B				
						110	--	<b>3RT2448-1AF00</b>	1	1 unit	41B				
						230	--	<b>3RT2448-1AP00</b>	1	1 unit	41B				

##### AC/DC operation

##### With integrated coil circuit (varistor integrated in electronics at the factory)

<b>S3</b>	<b>140</b>	130	<b>11</b>	1	1	--	20 ... 33	<b>3RT2446-1NB30</b>	1	1 unit	41B				
						--	83 ... 155					<b>3RT2446-1NF30</b>	1	1 unit	41B
						--	175 ... 280					<b>3RT2446-1NP30</b>	1	1 unit	41B
	<b>160</b>	140	<b>11</b>	1	1	--	20 ... 33	<b>3RT2448-1NB30</b>	1	1 unit	41B				
						--	83 ... 155	<b>3RT2448-1NF30</b>	1	1 unit	41B				
						--	175 ... 280	<b>3RT2448-1NP30</b>	1	1 unit	41B				

Other voltages according to page 4/52 on request.

Accessories and spare parts, see page 3/71 onwards.

## Switching devices – Contactors and contactor assemblies – Special applications

### Contactors for special applications

#### SIRIUS 3RT.4 contactors for weak or non-inductive loads (AC-1), 3-pole up to 2 650 A

##### Sizes S6 to S12: AC/DC operation

- 3RT14...-A standard operating mechanism
- Solid-state operating mechanism
  - 3RT14...-N with 24 V DC control signal input
  - 3RT14...-P with 24 V DC control signal input and remaining lifetime indicator (RLT)
- For screw fixing
- Auxiliary and control conductors: Screw terminals
- Main conductors: Busbar connections; a connection kit with screws, spring washers and nuts is enclosed.



3RT1456-6A.36



3RT1466-6A.36





3RT1476-6A.36



3RT1476-6N.36



3RT1476-6P.35

Size	Rated data	Auxiliary contacts, lateral	Rated control supply voltage $U_s$	Screw terminals 	PU (UNIT, SET, M)	PS*	PG
	AC-1, $t_{ij}$ : 40 °C Operational current $I_e$ up to	Version	50/60 Hz AC or DC	Article No.	Price per PU		
	690 V A	  NO NC V					

##### Standard operating mechanism for AC and DC operation (power consumption reduced from closing to closed)

###### With integrated coil circuit (varistor integrated at the factory)

<b>S6</b>	<b>275</b>	250	2	2	110 ... 127 220 ... 240	<b>3RT1456-6AF36</b>	1	1 unit	41B
						<b>3RT1456-6AP36</b>	1	1 unit	41B
<b>S10</b>	<b>400</b>	380	2	2	110 ... 127 220 ... 240	<b>3RT1466-6AF36</b>	1	1 unit	41B
						<b>3RT1466-6AP36</b>	1	1 unit	41B
	<b>500</b>	450	2	2	110 ... 127 220 ... 240	<b>3RT1467-6AF36</b>	1	1 unit	41B
						<b>3RT1467-6AP36</b>	1	1 unit	41B
<b>S12</b>	<b>690</b>	650	2	2	110 ... 127 220 ... 240	<b>3RT1476-6AF36</b>	1	1 unit	41B
						<b>3RT1476-6AP36</b>	1	1 unit	41B

##### Solid-state operating mechanism

###### With 24 V DC control signal input

###### e.g. for control by PLC

###### With integrated coil circuit (varistor integrated in electronics at the factory)

<b>S6</b>	<b>275</b>	250	2	2	96 ... 127 200 ... 277	<b>3RT1456-6NF36</b>	1	1 unit	41B
						<b>3RT1456-6NP36</b>	1	1 unit	41B
<b>S10</b>	<b>400</b>	380	2	2	96 ... 127 200 ... 277	<b>3RT1466-6NF36</b>	1	1 unit	41B
						<b>3RT1466-6NP36</b>	1	1 unit	41B
	<b>500</b>	450	2	2	96 ... 127 200 ... 277	<b>3RT1467-6NF36</b>	1	1 unit	41B
						<b>3RT1467-6NP36</b>	1	1 unit	41B
<b>S12</b>	<b>690</b>	650	2	2	96 ... 127 200 ... 277	<b>3RT1476-6NF36</b>	1	1 unit	41B
						<b>3RT1476-6NP36</b>	1	1 unit	41B

###### With 24 V DC control signal input · with remaining lifetime indicator (RLT)

###### e.g. for control by PLC

###### With integrated coil circuit (varistor integrated in electronics at the factory)

<b>S6</b>	<b>275</b>	250	1	1	96 ... 127 200 ... 277	<b>3RT1456-6PF35</b>	1	1 unit	41B
						<b>3RT1456-6PP35</b>	1	1 unit	41B
<b>S10</b>	<b>400</b>	380	1	1	96 ... 127 200 ... 277	<b>3RT1466-6PF35</b>	1	1 unit	41B
						<b>3RT1466-6PP35</b>	1	1 unit	41B
	<b>500</b>	450	1	1	96 ... 127 200 ... 277	<b>3RT1467-6PF35</b>	1	1 unit	41B
						<b>3RT1467-6PP35</b>	1	1 unit	41B
<b>S12</b>	<b>690</b>	650	1	1	96 ... 127 200 ... 277	<b>3RT1476-6PF35</b>	1	1 unit	41B
						<b>3RT1476-6PP35</b>	1	1 unit	41B

Other voltages [according to page 4/53](#) on request.

Accessories and spare parts, [see page 3/71 onwards](#).



## Switching devices – Contactors and contactor assemblies – Special applications

### Contactors for special applications

#### SIRIUS 3RT.4 contactors for weak or non-inductive loads (AC-1), 3-pole up to 2 650 A

##### Sizes S6 to S12: AC/DC operation

- Certified and fail-safe 24 V DC control input with max. 20 mA, e.g. for control via the fail-safe output module of a controller (F-PLC) or safety relay
- Achievable Safety Integrity Level (SIL) according to IEC 62061 and Performance Level (PL) according to ISO 13849-1 with corresponding fault diagnostics:
  - With one contactor: SIL 2 or PL c
  - With two contactors in series: SIL 3 or PL e
  - Fail-safe applications can be implemented using this contactor.
- Version with removable lateral auxiliary switches or permanently mounted auxiliary switches
- For screw fixing
- Auxiliary and control conductors: Screw terminals
- Main conductors: Busbar connections; a connection kit with screws, spring washers and nuts is enclosed.

For more information, see

- [Safety technology, page 11/1 onwards](#)
- [Guide of use for contactors in safety applications](#)





3RT1456-6S.36

3RT1466-6S.36

3RT1476-6S.36

3RT1456-6S.36-3PA0

3RT1476-6S.36-3PA0

Size	Rated data according to IEC 60947-4-1 AC-1, $t_U$ : 40 °C   60 °C Operational current $I_e$ up to <b>690 V</b> A	Auxiliary contacts, lateral  Version   V	Rated control supply voltage $U_s$  50/60 Hz AC or DC	Screw terminals 	PU (UNIT, SET, M)	PS*	PG
				Article No.	Price per PU		

#### Solid-state operating mechanism

##### With two removable laterally mounted auxiliary switches

With integrated coil circuit (varistor integrated in electronics at the factory)

Size	275	250	2	2	96 ... 127 200 ... 277	3RT1456-6SF36 3RT1456-6SP36	1	1 unit	41B
S10	400	380	2	2	96 ... 127 200 ... 277	3RT1466-6SF36 3RT1466-6SP36	1	1 unit	41B
	500	450	2	2	96 ... 127 200 ... 277	3RT1467-6SF36 3RT1467-6SP36	1	1 unit	41B
S12	690	650	2	2	96 ... 127 200 ... 277	3RT1476-6SF36 3RT1476-6SP36	1	1 unit	41B

##### With two permanently laterally mounted auxiliary switches

With integrated coil circuit (varistor integrated in electronics at the factory)

Size	275	250	2	2	96 ... 127 200 ... 277	3RT1456-6SF36-3PA0 3RT1456-6SP36-3PA0	1	1 unit	41B
S10	400	380	2	2	96 ... 127 200 ... 277	3RT1466-6SF36-3PA0 3RT1466-6SP36-3PA0	1	1 unit	41B
	500	450	2	2	96 ... 127 200 ... 277	3RT1467-6SF36-3PA0 3RT1467-6SP36-3PA0	1	1 unit	41B
S12	690	650	2	2	96 ... 127 200 ... 277	3RT1476-6SF36-3PA0 3RT1476-6SP36-3PA0	1	1 unit	41B

Accessories and spare parts, see page 3/71 onwards.

## Switching devices – Contactors and contactor assemblies – Special applications

### Contactors for special applications

#### SIRIUS 3RT.4 contactors for weak or non-inductive loads (AC-1), 3-pole up to 2 650 A

#### AC/DC operation

- Solid-state operating mechanism
- Version with two laterally mounted auxiliary switches (2 NO + 2 NC each)
- For screw fixing
- Auxiliary and control conductors: Screw terminals
- Main conductors: Busbar connections

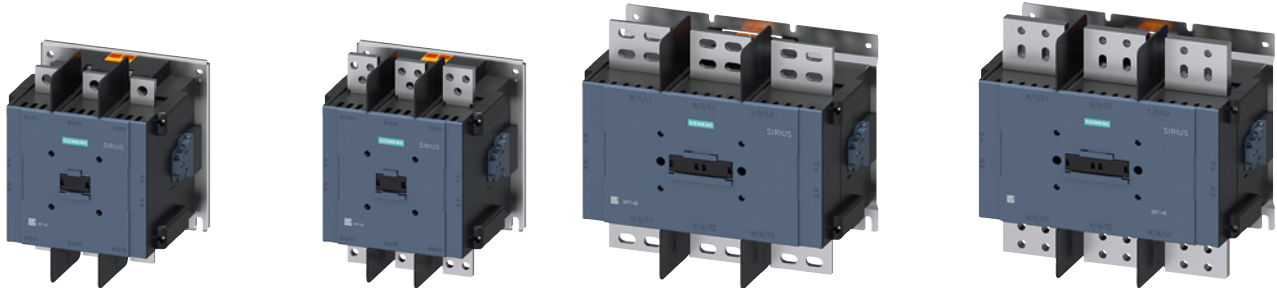

Rated data according to IEC 60947-4-1 AC-1, $t_j$ : 40 °C Operational current $I_e$ up to <b>1 000 V</b>	Auxiliary contacts, lateral Version	Rated control supply voltage $U_s$ 50/60 Hz AC    DC	<b>Busbar connections</b>				
	 NO    NC	V    V	Article No.	Price per PU	PU (UNIT, SET, M)	PS*	PG

#### Solid-state operating mechanism

#### With integrated coil circuit

Rated current	NO	NC	50/60 Hz AC	DC	Article No.	PU	PS*	PG
<b>900</b>	2	2	100 ... 127	100 ... 110	<b>3RT1481-6AF36</b>	1	1 unit	41B
			200 ... 240	200 ... 220	<b>3RT1481-6AP36</b>	1	1 unit	41B
<b>1 050</b>	2	2	100 ... 127	100 ... 110	<b>3RT1482-6AF36</b>	1	1 unit	41B
			200 ... 240	200 ... 220	<b>3RT1482-6AP36</b>	1	1 unit	41B
<b>1 260</b>	2	2	100 ... 240	100 ... 220	<b>3RT1483-6AP36</b>	1	1 unit	41B
<b>1 700</b>	2	2	100 ... 240	100 ... 220	<b>3RT1485-6AP36</b>	1	1 unit	41B
<b>2 100</b>	2	2	100 ... 240	100 ... 220	<b>3RT1486-6AP36</b>	1	1 unit	41B
<b>2 650</b>	2	2	100 ... 240	100 ... 220	<b>3RT1487-6AP36</b>	1	1 unit	41B

Accessories, [see next table](#); spare parts, [see page 4/19](#).

#### Accessories

Overview graphics for 3RT148 contactors with mountable accessories, [see page 4/10](#).

#### More information

Manuals, [see https://support.industry.siemens.com/cs/ww/en/ps/24229/man](https://support.industry.siemens.com/cs/ww/en/ps/24229/man)

For contactors	Auxiliary contacts Version				<b>Screw terminals</b>			
	 NO    NC	Left    Right	Article No.	Price per PU	PU (UNIT, SET, M)	PS*	PG	

#### Second auxiliary switch (1 NO + 1 NC)

Lateral mounting on the right and/or the left

3RT148.	1	1		
---------	---	---	--	--



3RH1981-1JA11









<b>3RH1981-1JA11</b>		1	1 unit	41B
----------------------	--	---	--------	-----

# Switching devices – Contactors and contactor assemblies – Special applications

## Contactors for special applications

### SIRIUS 3RT.4 contactors for weak or non-inductive loads (AC-1), 3-pole up to 2 650 A

#### Spare parts

For contactors	Auxiliary contacts		Rated control supply voltage $U_s$		Article No.	Price per PU	PU (UNIT, SET, M)	PS*	PG	
	Version		50/60 Hz AC	DC						
Type	NO	NC	Left	Right	V	V				
<b>First auxiliary switch (1 NO + 1 NC)</b>										
	Lateral mounting on the right and/or the left				<b>Screw terminals</b> 					
3RH1981-1DA11	1	1			--	--	1	1 unit	41B	
										
<b>Phase barriers</b>										
	(1 set = 4 units)				<b>3RT1983-4AA1</b>		1	1 unit	41B	
3RT1481	--	--	--	--	--	--				
...										
3RT1483										
	3RT1983-4AA1				<b>3RT1987-4AA1</b>		1	1 unit	41B	
3RT1485	--	--	--	--	--	--				
...										
3RT1487										
	3RT1987-4AA1				<b>3RT1982-5AF31</b>		1	1 unit	41B	
<b>Withdrawable coils - AC/DC operation</b>										
	3RT1481,	--	--	--	100 ... 127	100 ... 110	<b>3RT1982-5AF31</b>	1	1 unit	41B
	3RT1482	--	--	--	200 ... 240	200 ... 220	<b>3RT1982-5AP31</b>	1	1 unit	41B
	3RT1483	--	--	--	100 ... 240	100 ... 220	<b>3RT1983-5AP31</b>	1	1 unit	41B
3RT1982-5A,31, 3RT1983-5AP31										
	3RT1485	--	--	--	100 ... 240	100 ... 220	<b>3RT1987-5AP31</b>	1	1 unit	41B
	...									
	3RT1487									
3RT1987-5AP31										

## Switching devices – Contactors and contactor assemblies – Special applications

### Contactors for special applications

SIRIUS 3RT.3 contactors, 4-pole, up to 525 A

#### Overview

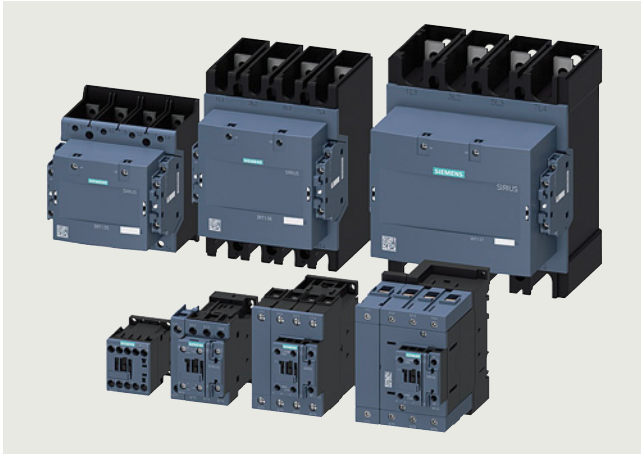

3RT231 to 3RT234 and 3RT135 to 3RT137 contactors, with screw terminals

#### Standards

IEC 60947-1, IEC 60947-4-1, IEC60947-5-1 (auxiliary switches)

#### Protecting connections against short circuit, overload and overvoltage

All connections must generally be protected against overload and short circuits using suitable measures. Different constraints must be considered depending on the type of connection:

##### Short-circuit and overload protection of main connections

For information on the protection of a free-standing contactor, [see the technical product data sheet](#).

For more information on device combinations such as contactor with overload relay or contactor with circuit breaker as motor feeder, refer to

- [Digital Configuration Manual for load feeders](#)
- [Configuration Manual for load feeders](#)

##### Short-circuit and overload protection of auxiliary connections

For information on the protection of auxiliary contacts, [see the technical product data sheet](#).

##### Short-circuit and overload protection of control supply voltage or supply voltage connections

First of all, the relevant standards and regulations for configuring control panels and the parts and components installed in them must be taken into account, for example for cable dimensioning.

One possible protection for these circuits could be the selection of a suitable power supply, i.e. one with a current-limiting function. In the selection of the source and the connecting cable, the load characteristics of the contactor must be considered (short-time inrush current peaks for solid-state contactor operating mechanisms, switch-on power, holding power). The same applies to the selection of suitable protection devices.

If there are further switching elements in the circuit, such as the auxiliary contact system of an overload relay that operates the contactor, the short-circuit protection necessary for this must also be considered.

For further recommendations, e.g. the use of miniature circuit breakers or circuit breakers for equipment in control circuits, [see Control panel tip – Selecting and dimensioning suitable power supplies quickly and reliably](#).

##### Protection against overvoltage at the control supply voltage connection

3RT23 contactors supplied without a coil circuit can be retrofitted with RC elements, varistors, diodes or diode assemblies (combination of diode and Zener diode for short break times) for damping switching overvoltages in the coil and can be ordered separately as accessories, [see page 3/102 onwards](#).

3RT13 contactors are already equipped with coil damping (varistor).

##### Note:

The break times of the contactor, the opening delay times of the NO contacts and the closing delay times of the NC contacts increase in the event of damping.

For more information about influencing the time response using damping, [see Equipment Manual](#).

#### Connection methods

##### Main circuit

- 3RT231 and 3RT232 contactors:  
Screw terminals or spring-loaded terminals; spring-loaded terminals with convenient plug-in design for device connectors
- 3RT233 and 3RT234 contactors:  
Screw terminals with box terminal; direct connection to the connecting bar possible with cable lugs for 3RT234 when the box terminal is removed.
- 3RT135 to 3RT137 contactors:  
Screw terminals with connecting bars that the cables can be connected to using either cable lugs or flexible or rigid busbars.
- 3RT136 and 3RT137 contactors:  
These can be fitted with bus connectors offset, [see page 4/35](#).

##### Auxiliary and control circuits

Screw terminals

#### Electromagnetic compatibility

The contactors fulfill the requirements for environment category A.

##### Note:

When the contactors are used in an environment with frequency converters, the configuration notes must be observed, [see Equipment Manual](#).

## Switching devices – Contactors and contactor assemblies – Special applications

### Contactors for special applications

#### SIRIUS 3RT.3 contactors, 4-pole, up to 525 A

##### Contact reliability of the auxiliary contacts

If voltages  $\leq 110$  V and currents  $\leq 100$  mA are to be switched, the auxiliary contacts of the 3RT contactors or 3RH contactor relays should be used as they guarantee a high level of contact reliability.

These auxiliary contacts are particularly suitable for solid-state circuits with currents  $\geq 1$  mA at a voltage  $\geq 17$  V.

##### Motor protection

###### 3RT23 contactors

For protection against overload, 3RU2 thermal overload relays (see page 7/86 onwards) or 3RB3 electronic overload relays (see pages 7/98, 7/100 and 7/102) can be mounted on the 3RT23 contactors.

###### 3RT13 contactors

For protection against overload, 3RB2 electronic overload relays (see pages 7/99, 7/101 and 7/103) can be mounted on the 3RT13 contactors.

##### Operating mechanism types

###### 3RT23 contactors

The contactors are available as versions with conventional AC or DC operating mechanisms or as versions with a wide-range solid-state operating mechanism and a universal actuating voltage (AC or DC operation possible).

Control takes place via the control supply voltage connection A1 - A2 with varying operating ranges (see relevant product data sheet for further details).

###### 3RT13 contactors

The contactors are fitted with a wide-range solid-state operating mechanism that can be controlled with both 50/60 Hz AC and DC.

The operating range with DC control is  $0.8 \times U_{s \text{ min}}$  and  $1.1 \times U_{s \text{ max}}$ , and with AC control  $0.85 \times U_{s \text{ min}}$  and  $1.1 \times U_{s \text{ max}}$ .

##### Replacing solenoid coils, operating mechanisms or spare contacts

###### 3RT23 contactors

Solenoid coil replacement is possible. Only the contacts for 3RT233 contactors can be replaced.

###### 3RT13 contactors

It is not possible to change the operating mechanism or contacts.

##### Fitting auxiliary contacts and mounting additional auxiliary switches

###### Features in the delivery state

- 3RT23 contactors
  - 3RT231 contactor:
    - An auxiliary contact is integrated in the basic unit.
  - 3RT232 to 3RT234 contactors:
    - The basic units contain two integrated auxiliary contacts (1 NO + 1 NC).
- 3RT13 contactors
  - These contactors are supplied with two laterally mounted auxiliary switches.

###### Expansion possibilities

All basic units can be expanded using auxiliary switches; the permissible configuration must be observed.

For detailed information about the fitting of auxiliary switches for 3RT23 contactors, see pages 3/83 to 3/90.

##### Accessories and spare parts

- 3RT231 to 3RT234 contactors, see page 3/71 onwards
- 3RT135 to 3RT137 contactors, see page 4/35



## Switching devices – Contactors and contactor assemblies – Special applications

### Contactors for special applications

SIRIUS 3RT.3 contactors, 4-pole, up to 525 A

#### Overview graphic with mountable accessories

- 3RT23 contactors, [see page 3/8 onwards](#)
- 3RT135 to 3RT137 contactors, [see following graphic](#)

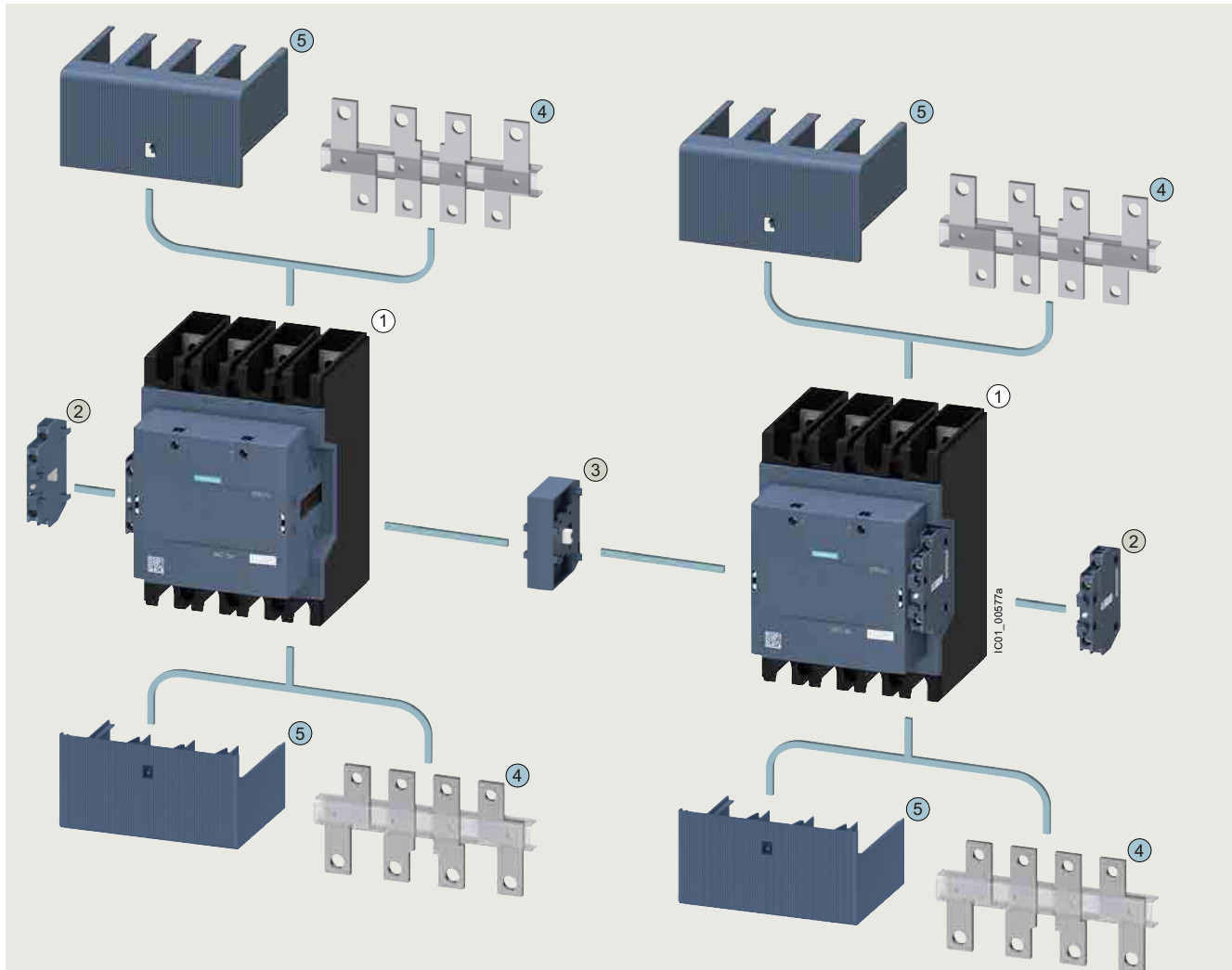

- ① 4-pole 3RT13 contactors, sizes S6 to S12 (scope of supply: The contactors are supplied with two laterally mounted auxiliary switches)
- ② 3RH1951-1SA11 second auxiliary switch, can be laterally mounted on the left or right
- ③ 3RA1954-3A mechanical interlock for configuring contactor assemblies:  
Two 3RT13 contactors of the same size (S6, S10 and S12) can be interlocked with each other. The laterally mounted auxiliary switches of the contactors must be removed beforehand. The mechanical interlock cannot be used in conjunction with the bus connectors offset ④.

- ④ 3RT19.6-4D bus connectors offsets, can be mounted on the top or bottom (providing no terminal cover ⑤ is mounted)
- ⑤ 3RT19.6-4EB10 terminal covers, can be mounted on the top or bottom (providing no bus connectors offset ④ is mounted)

- Same accessories for sizes S6 to S12
- Different accessories depending on size

Size	S6	S10	S12
① Contactor	3RT1355 ( $I_o = 200$ A)	3RT1363 ( $I_o = 275$ A)	3RT1364 ( $I_o = 350$ A)
② Second auxiliary switch	3RH1951-1SA11		
③ Mechanical interlock	3RA1954-3A		
④ Bus connectors offset	--	3RT1966-4D (from $I > 275$ A)	3RT1976-4D (from $I > 450$ A)
⑤ Terminal cover	3RT1956-4EB10	3RT1966-4EB10	3RT1976-4EB10

3RT135 to 3RT137 contactors with mountable accessories

# Switching devices – Contactors and contactor assemblies – Special applications

## Contactors for special applications

### SIRIUS 3RT.3 contactors, 4-pole, up to 525 A

#### Application

The 3RT.3 contactors can be used for the following applications:

- 4-pole switching of weak or non-inductive loads (AC-1)
- Disconnecting loads or power generation plants from the grid
- For system transfers

We additionally offer special versions of the 3RT23 contactors for switching motor-driven loads (AC-3).

#### Technical specifications

##### More information

Technical specifications, see  
<https://support.industry.siemens.com/cs/ww/en/ps/16165/td>  
 FAQs, see <https://support.industry.siemens.com/cs/ww/en/ps/16165/faq>

Manuals, see  
<https://support.industry.siemens.com/cs/ww/en/ps/16165/man>

Type	3RT2316, 3RT2317	3RT2325 to 3RT2327	3RT2336, 3RT2337	3RT2344, 3RT2346, 3RT2348
Size	S00	S0	S2	S3
<b>General data</b>				
<b>Dimensions (W x H x D)</b>	(The values in brackets apply for DC operation)			
AC or DC operation				
• Basic units				
- Screw terminals	mm 45 x 58 x 73	mm 60 x 85 x 97 (107)	mm 75 x 114 x 130	mm 96 x 140 x 152
- Spring-loaded terminals	mm 45 x 70 x 73	mm 61 x 102 x 97 (107)	--	--
• Basic unit with mounted auxiliary switch				
- Screw terminals	mm 45 x 58 x 117	mm 60 x 85 x 141 (151)	mm 75 x 114 x 174	mm 96 x 140 x 196
- Spring-loaded terminals	mm 45 x 70 x 121	mm 61 x 102 x 145 (155)	--	--
• Basic unit with mounted function module or solid-state time-delay auxiliary switch				
- Screw terminals	mm 45 x 58 x 147	mm 60 x 85 x 171 (181)	mm 75 x 114 x 204	mm 96 x 140 x 226
- Spring-loaded terminals	mm 45 x 70 x 147	mm 61 x 102 x 171 (181)	--	--
<b>Permissible mounting position</b>				
The contactors are designed for operation on a vertical mounting surface.				
Upright mounting position				
<b>Mechanical endurance</b>	Operating cycles	30 million	10 million	
<b>Electrical endurance at I<sub>e</sub>/AC-1</b>	Operating cycles	Approx. 0.5 million		
<b>Rated insulation voltage U<sub>i</sub></b> (pollution degree 3)	V	690		
<b>Protective separation</b> between the coil and the main contacts according to IEC 60947-1, Annex N	V	400		690
<b>Permissible ambient temperature</b>				
• During operation	°C	-25 ... +60		
• During storage	°C	-55 ... +80		

## Switching devices – Contactors and contactor assemblies – Special applications

### Contactors for special applications

#### SIRIUS 3RT.3 contactors, 4-pole, up to 525 A

Type Size	3RT2316, 3RT2317 S00	3RT2325, 3RT2326 S0	3RT2326-1...0-4AA0	3RT2327
<b>Short-circuit protection</b>				
<b>Main circuit</b>				
<ul style="list-style-type: none"> <li>Version of the fuse link required for short-circuit protection of the main circuit</li> <li>- For type of coordination 1</li> <li>- For type of coordination 2</li> </ul>	gG: 35 A (690 V, 100 kA)	gG: 63 A (690 V, 100 kA)	gG: 100 A (690 V, 100 kA), aM: 50 A (690 V, 100 kA), BS88: 100 A (415 V, 80 kA)	gG: 63 A (690 V, 100 kA)
	gG: 20 A (690 V, 100 kA)		gG: 35 A (690 V, 100 kA), aM: 20 A (690 V, 100 kA), BS88: 35 A (415 V, 80 kA)	gG: 20 A (690 V, 100 kA)
<b>Auxiliary circuit</b>				
<ul style="list-style-type: none"> <li>Version of the fuse link required for short-circuit protection of the auxiliary switch</li> <li>Version of the miniature circuit breaker required for short-circuit protection of the auxiliary switch</li> </ul>	Fuse gG: 10 A (690 V, 1 kA)			
	6 A (230 V, 400 A, C characteristic)			

Type Size	3RT2336, 3RT2337 S2	3RT2344, 3RT2346 S3	3RT2346-1...0-4AA0	3RT2348
<b>Short-circuit protection</b>				
<b>Main circuit</b>				
<ul style="list-style-type: none"> <li>Version of the fuse link required for short-circuit protection of the main circuit</li> <li>- For type of coordination 1</li> <li>- For type of coordination 2</li> </ul>	gG: 160 A (690 V, 100 kA)	gG: 250 A (690 V, 100 kA)	gG: 250 A (690 V, 100 kA), aM: 160 A (690 V, 100 kA), BS88: 200 A (415 V, 80 kA)	gG: 250 A (690 V, 100 kA)
	gG: 63 A (690 V, 100 kA)	gR: 80 A (690 V, 100 kA)	gR: 250 A (690 V, 100 kA)	gG: 160 A (690 V, 100 kA), aM: 100 A (690 V, 100 kA), BS88: 125 A (415 V, 80 kA)
				gR: 250 A (690 V, 100 kA)
<b>Auxiliary circuit</b>				
<ul style="list-style-type: none"> <li>Version of the fuse link required for short-circuit protection of the auxiliary switch</li> <li>Version of the miniature circuit breaker required for short-circuit protection of the auxiliary switch</li> </ul>	Fuse gG: 10 A (690 V, 1 kA)			
	6 A (230 V, 400 A, C characteristic)			

## Switching devices – Contactors and contactor assemblies – Special applications

### Contactors for special applications

#### SIRIUS 3RT.3 contactors, 4-pole, up to 525 A

Type		3RT2316	3RT2317	3RT2325	3RT2326, 3RT2327	3RT2336, 3RT2337	3RT2344, 3RT2346, 3RT2348
Size		S00		S0		S2	S3
<b>Control</b>							
<b>Solenoid coil operating range</b>							
• AC operation	At 50 Hz	0.8 ... 1.1 × $U_s$		0.8 ... 1.1 × $U_s$			
	At 60 Hz	0.85 ... 1.1 × $U_s$					
• DC operation	At 50 °C	0.8 ... 1.1 × $U_s$				--	
	At 60 °C	0.85 ... 1.1 × $U_s$				--	
• AC/DC operation						0.8 ... 1.1 × $U_s$	
<b>Power consumption of the solenoid coils</b> (for cold coil and 1.0 × $U_s$ )							
• AC operation, 50 Hz, standard version							
- Closing	VA	--		77		190	296
- P.f.		--		0.82		0.72	0.61
- Closed	VA	--		9.8		16	19
- P.f.		--		0.25		0.37	0.38
• AC operation, 50/60 Hz, standard version							
- Closing	VA	27/24.3	37/33	81/79		210/188	348/296
- P.f.		0.8/0.75		0.72/0.74		0.69/0.65	0.62/0.55
- Closed	VA	4.2/3.3	5.7/4.4	10.5/8.5		17.2/16.5	25/18
- P.f.		0.25/0.25		0.25/0.28		0.36/0.39	0.35/0.41
• AC operation, 60 Hz, USA, Canada							
- Closing	VA	31.7	43	87		188	326
- P.f.		0.77		0.76		0.67	0.55
- Closed	VA	4.8	6.5	9.4		16.5	22
- P.f.		0.25		0.28		0.37	0.4
• AC/DC operation							
- Closing for AC operation	VA	--				40	151
- P.f.		--				0.95	0.95
- Closed for AC operation	VA	--				2	3.5
- P.f.		--				0.95	0.95
- Closing for DC operation	W	--				23	76
- Closed for DC operation	W	--				1	2.7
• DC operation (closing = closed)	W	4		5.9		--	... <sup>1)</sup>

<sup>1)</sup> In the case of AC/DC coils, increased pickup currents (6.5 A on average) arise during the first 200 ms.

Type		3RT2316	3RT2317	3RT2325	3RT2326	3RT2327	3RT2336	3RT2337	3RT2344	3RT2346	3RT2348	
Size		S00		S0			S2		S3			
<b>Rated data of the main contacts</b>												
<b>Load rating with AC</b>												
<b>Utilization category AC-1</b>												
• Rated operational currents $I_e$	At 40 °C, up to 690 V	A	18	22	35	40	50	60	110	110	140 (110) <sup>1)</sup>	160
	At 60 °C, up to 690 V	A	16	20	30	35	42	55	95	100	130 (100) <sup>1)</sup>	140
• Rated power for AC loads	at 230 V	kW	6	7.5	11	13	16	21	36	38	49	53
	400 V	kW	10.5	13	20	23	28	36	63	72	92	105
	P.f. = 0.95 (at 60 °C)											
• Minimum cross-section in the main circuit at maximum AC-1 rated value		mm <sup>2</sup>	2.5	4	10			16	35		50 (35) <sup>1)</sup>	70
<b>Power loss per main conducting path</b>												
• At $I_e$ /AC-1	At 40 °C	W	1.1	1.6	1.8	2.4	3	3.2	9.7	7.3	11.8	15.4
• At $I_e$ /AC-3	At 400 V	W	--	--	--	(2.6) <sup>1)</sup>	--	(4.3) <sup>1)</sup>	--	--	(6.8) <sup>1)</sup>	--

<sup>1)</sup> The values in brackets apply for 3RT23.6-1...0-4AA0 versions.

#### Data for North America

Technical specifications of 3RT contactors, [see page 3/45 onwards](#).

# Switching devices – Contactors and contactor assemblies – Special applications

## Contactors for special applications

### SIRIUS 3RT.3 contactors, 4-pole, up to 525 A

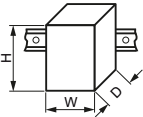
Type		<b>3RT1355-6A.36</b>	<b>3RT1363-6A.36</b>	<b>3RT1364-6A.36</b>	<b>3RT1373-6A.36, 3RT1374-6A.36, 3RT1375-6A.36</b>								
Size		<b>S6</b>	<b>S10</b>		<b>S12</b>								
<b>General data</b>													
<b>Dimensions</b>													
<ul style="list-style-type: none"> <li>• Width</li> <li>• Height</li> <li>• Depth</li> </ul>		mm	120	140	184								
		mm	150	196	225								
		mm	128	153	180								
<b>Mounting position</b>													
For vertical mounting surface can be rotated $\pm 180^\circ$ , and with $0^\circ$ rotation can be tilted forward or backward $\pm 30^\circ$ , or standing													
<b>Installation altitude at height above sea level, maximum</b>													
m		2 000											
<b>Insulation voltage at pollution degree 3</b>													
<ul style="list-style-type: none"> <li>• Of the main circuit</li> <li>• Of the auxiliary circuit</li> </ul>	V	1 000											
	V	690											
<b>Impulse withstand voltage</b>													
<ul style="list-style-type: none"> <li>• Of the main circuit</li> <li>• Of the auxiliary circuit</li> </ul>	kV	8											
	kV	6											
<b>Product function, mirror contact according to IEC 60947-4-1</b>													
Yes													
<b>Ambient temperature</b>													
<ul style="list-style-type: none"> <li>• During operation</li> <li>• During storage</li> </ul>	$^\circ\text{C}$	-40 ... +60											
	$^\circ\text{C}$	-40 ... +70											
<b>Short-circuit protection</b>													
<b>Version of the fuse link required</b>													
<ul style="list-style-type: none"> <li>• For short-circuit protection of the main circuit for type of coordination 2</li> <li>• For short-circuit protection of the auxiliary switch</li> </ul>		gG: 250 A (500 V, 100 kA)	gG: 355 A (500 V, 100 kA)	gG: 400 A (500 V, 100 kA)	gG: 630 A (500 V, 100 kA)								
		gG: 10 A (690 V, 1 kA)											
Type		<b>3RT1355-</b>				<b>3RT1363-</b>				<b>3RT1364-</b>			
		<b>6AE36</b>	<b>6AF36</b>	<b>6AP36</b>	<b>6AR36</b>	<b>6AE36</b>	<b>6AF36</b>	<b>6AP36</b>	<b>6AR36</b>	<b>6AE36</b>	<b>6AF36</b>	<b>6AP36</b>	<b>6AR36</b>
Size		<b>S6</b>				<b>S10</b>							
<b>Control circuit/control</b>													
<b>Operating range factor of the control supply voltage, rated value of the solenoid coil</b>													
<ul style="list-style-type: none"> <li>• At AC at 50 Hz</li> <li>• At AC at 60 Hz</li> <li>• At DC</li> </ul>		0.85 ... 1.1											
		0.85 ... 1.1											
		0.8 ... 1.1											
<b>Solenoid coil closing for DC</b>													
W		210	130	135	205	130	190	205	130	190	205	130	190
<b>Closing apparent power of the solenoid coil for AC</b>													
<ul style="list-style-type: none"> <li>• At 50 Hz</li> <li>• At 60 Hz</li> </ul>	VA	225	170	130	205	165	175	220	185	165	175	220	185
	VA	225	170	130	205	165	175	220	185	165	175	220	185
<b>Solenoid coil closed for DC</b>													
W		2.5		3	4	2.5		4	2.5		4		4
<b>Closed apparent power of the solenoid coil for AC</b>													
<ul style="list-style-type: none"> <li>• At 50 Hz</li> <li>• At 60 Hz</li> </ul>	VA	5.5	4	6	16	6	4	7	16	6	4	7	16
	VA	5.5	4	6	16	6	4	7	16	6	4	7	16
<b>Main circuit</b>													
<b>Operational current at AC-1</b>													
<ul style="list-style-type: none"> <li>• Up to 690 V</li> <li>- At an ambient temperature of 40 <math>^\circ\text{C}</math></li> <li>- At an ambient temperature of 60 <math>^\circ\text{C}</math></li> </ul>	A	200				275				350			
	A	175				250				300			
<ul style="list-style-type: none"> <li>• Up to 1 000 V</li> <li>- At an ambient temperature of 40 <math>^\circ\text{C}</math></li> <li>- At an ambient temperature of 60 <math>^\circ\text{C}</math></li> </ul>	A	--				250				275			
	A	--				225				250			

## Switching devices – Contactors and contactor assemblies – Special applications

### Contactors for special applications

#### SIRIUS 3RT.3 contactors, 4-pole, up to 525 A

Type	3RT1373-				3RT1374-				3RT1375-				
Size	6AE36	6AF36	6AP36	6AR36	6AE36	6AF36	6AP36	6AR36	6AE36	6AF36	6AP36	6AR36	
<b>Control circuit/control</b>													
<b>Operating range factor of the control supply voltage, rated value of the solenoid coil</b>													
• At AC at 50 Hz	0.85 ... 1.1												
• At AC at 60 Hz	0.85 ... 1.1												
• At DC	0.8 ... 1.1												
<b>Solenoid coil closing for DC</b>	W	400	360	410	600	400	360	410	600	400	360	410	600
<b>Closing apparent power of the solenoid coil for AC</b>													
• At 50 Hz	VA	475	340	385	420	475	340	385	420	475	340	385	420
• At 60 Hz	VA	475	340	385	420	475	340	385	420	475	340	385	420
<b>Solenoid coil closed for DC</b>	W	3.5	2.5	4.5	4.7	3.5	2.5	4.5	4.7	3.5	2.5	4.5	4.7
<b>Closed apparent power of the solenoid coil for AC</b>													
• At 50 Hz	VA	8.5	17	17.5	21	8.5	17	17.5	21	8.5	17	17.5	21
• At 60 Hz	VA	8.5	17	17.5	21	8.5	17	17.5	21	8.5	17	17.5	21
<b>Main circuit</b>													
<b>Operational current at AC-1</b>													
• Up to 690 V													
- At an ambient temperature of 40 °C	A	400				500				525			
- At an ambient temperature of 60 °C	A	350				400				425			
• Up to 1 000 V													
- At an ambient temperature of 40 °C	A	350				375				400			
- At an ambient temperature of 60 °C	A	300				325				350			
Type	3RT1355-6A.36		3RT1363-6A.36		3RT1364-6A.36		3RT1373-6A.36		3RT1374-6A.36		3RT1375-6A.36		
Size	S6		S10		S12		S12		S12		S12		
<b>Conductor cross-sections</b>													
<b>Type of electrical connection for the main circuit</b>													
Connecting bar													
Connecting bar, bus connectors offset > 275 A required													
Connecting bar													
Connecting bar, bus connectors offset > 450 A required													
<b>Minimum cross-section in the main circuit at maximum AC-1 rated value</b>	mm <sup>2</sup>	95		150		240		300		370			



# Switching devices – Contactors and contactor assemblies – Special applications

## Contactors for special applications

### SIRIUS 3RT.3 contactors, 4-pole, up to 525 A

#### Selection and ordering data

##### AC operation

PU (UNIT, SET, M) = 1  
 PS\* = 1 unit  
 PG = 41B

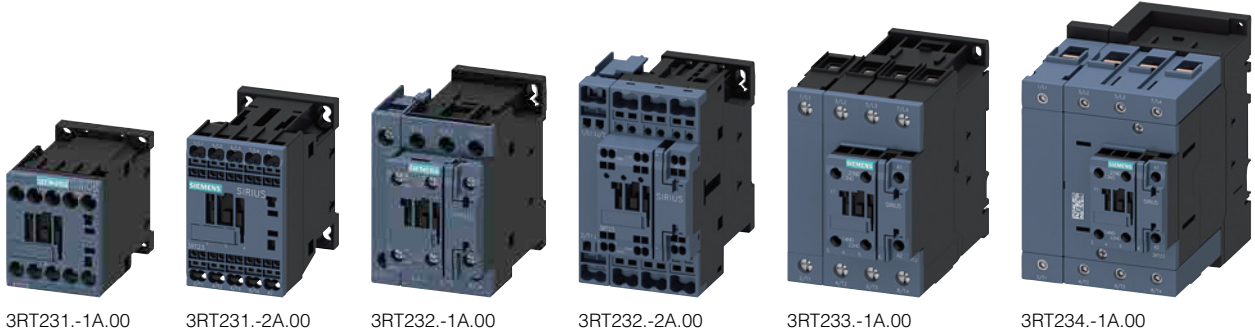

3RT231.-1A.00





3RT231.-2A.00

3RT232.-1A.00

3RT232.-2A.00

3RT233.-1A.00

3RT234.-1A.00

Rated data AC-1, $t_{ij}$ : 40/60 °C Operational current $I_e$ up to 690 V	Auxiliary contacts		Rated control supply voltage $U_s$		Screw terminals 		Spring-loaded terminals 	
	Ident. No.	Version	50/60 Hz AC	50 Hz AC	Article No.	Price per PU	Article No.	Price per PU
A		 	V	V				

#### For screw fixing and snap-on mounting on TH 35 DIN rail

##### Size S00

18/16	--	--	--	24 110 230	--	3RT2316-1AB00 3RT2316-1AF00 3RT2316-1AP00	3RT2316-2AB00 3RT2316-2AF00 3RT2316-2AP00
22/20	--	--	--	24 110 230	--	3RT2317-1AB00 3RT2317-1AF00 3RT2317-1AP00	3RT2317-2AB00 3RT2317-2AF00 3RT2317-2AP00

##### Size S0

35/30 <sup>1)</sup>	11	1	1	-- 24 110 230	--	3RT2325-1AB00 3RT2325-1AF00 3RT2325-1AP00	3RT2325-2AB00 3RT2325-2AF00 3RT2325-2AP00
40/35 <sup>1)</sup>	11	1	1	-- 24 110 230	--	3RT2326-1AB00 3RT2326-1AF00 3RT2326-1AP00	3RT2326-2AB00 3RT2326-2AF00 3RT2326-2AP00
50/42 <sup>1)</sup>	11	1	1	-- 24 110 230	--	3RT2327-1AB00 3RT2327-1AF00 3RT2327-1AP00	3RT2327-2AB00 3RT2327-2AF00 3RT2327-2AP00

##### Size S2

60/55	11	1	1	-- 24 110 230	--	3RT2336-1AB00 3RT2336-1AF00 3RT2336-1AP00	-- -- --
110/95	11	1	1	-- 24 110 230	--	3RT2337-1AB00 3RT2337-1AF00 3RT2337-1AP00	-- -- --

#### For screw fixing and snap-on mounting on TH 35-15 and TH 75-15 DIN rails

##### Size S3

110/100	11	1	1	-- 24 110 230	--	3RT2344-1AB00 3RT2344-1AF00 3RT2344-1AP00	-- -- --
140/130	11	1	1	-- 24 110 230	--	3RT2346-1AB00 3RT2346-1AF00 3RT2346-1AP00	-- -- --
160/140	11	1	1	-- 24 110 230	--	3RT2348-1AB00 3RT2348-1AF00 3RT2348-1AP00	-- -- --

<sup>1)</sup> Required conductor cross-section 10 mm<sup>2</sup>.

Other voltages [according to page 4/52](#) on request.  
 Accessories and spare parts, [see page 3/71 onwards](#).

## Switching devices – Contactors and contactor assemblies – Special applications

### Contactors for special applications

#### SIRIUS 3RT.3 contactors, 4-pole, up to 525 A

##### AC operation

Version for AC-3 motor loads

PU (UNIT, SET, M) = 1  
 PS\* = 1 unit  
 PG = 41B







3RT2326-1AP00-4AA0



3RT2336-1AP00-4AA0



3RT2346-1AP00-4AA0

Rated data		Auxiliary contacts	Rated control supply voltage $U_s$	Screw terminals 	Spring-loaded terminals 
AC-3/AC-3e, $t_U$ : up to 60 °C	AC-1, $t_U$ : 40/60 °C	Ident. No.   Version	50 Hz AC	Article No.	Article No.
Operational current $I_e$ up to 400 V	Operational current $I_e$ up to 690 V	  V		Price per PU	Price per PU
A	A				

#### For screw fixing and snap-on mounting on TH 35 DIN rail

##### Size S0

32      40/35      11      1      1      230

**3RT2326-1AP00-4AA0**

--

##### Size S2

50      60/55      11      1      1      230

**3RT2336-1AP00-4AA0**

--

#### For screw fixing and snap-on mounting on TH 35-15 and TH 75-15 DIN rails

##### Size S3

95      110/100      11      1      1      230

**3RT2346-1AP00-4AA0**

--

Other voltages according to page 4/52 on request.

Accessories and spare parts, see page 3/71 onwards.

# Switching devices – Contactors and contactor assemblies – Special applications

## Contactors for special applications

### SIRIUS 3RT.3 contactors, 4-pole, up to 525 A

#### DC operation

PU (UNIT, SET, M) = 1  
 PS\* = 1 unit  
 PG = 41B



3RT231.-1B.40



3RT231.-2B.40



3RT232.-1B.40



3RT232.-2B.40

Rated data  
 AC-1,  $t_c$ : 40/60 °C  
 Operational current  $I_e$   
 up to 690 V

Auxiliary contacts

Ident. No. | Version



Rated control supply  
 voltage  $U_s$   
 DC

**Screw terminals** 

Article No.

Price  
 per PU

**Spring-loaded terminals** 

Article No.

Price  
 per PU

#### For screw fixing and snap-on mounting on TH 35 DIN rail

##### Size S00

18/16	--	--	--	24 220	<b>3RT2316-1BB40</b> <b>3RT2316-1BM40</b>	<b>3RT2316-2BB40</b> <b>3RT2316-2BM40</b>
22/20	--	--	--	24 220	<b>3RT2317-1BB40</b> <b>3RT2317-1BM40</b>	<b>3RT2317-2BB40</b> <b>3RT2317-2BM40</b>

##### Size S0

35/30 <sup>1)</sup>	11	1	1	24 220	<b>3RT2325-1BB40</b> <b>3RT2325-1BM40</b>	<b>3RT2325-2BB40</b> <b>3RT2325-2BM40</b>
40/35 <sup>1)</sup>	11	1	1	24 220	<b>3RT2326-1BB40</b> <b>3RT2326-1BM40</b>	<b>3RT2326-2BB40</b> <b>3RT2326-2BM40</b>
50/42 <sup>1)</sup>	11	1	1	24 220	<b>3RT2327-1BB40</b> <b>3RT2327-1BM40</b>	<b>3RT2327-2BB40</b> <b>3RT2327-2BM40</b>

<sup>1)</sup> Required conductor cross-section 10 mm<sup>2</sup>.

Other voltages according to page 4/52 on request.

Accessories and spare parts, see page 3/71 onwards.

## Switching devices – Contactors and contactor assemblies – Special applications

### Contactors for special applications

#### SIRIUS 3RT.3 contactors, 4-pole, up to 525 A

##### AC/DC operation





PU (UNIT, SET, M) = 1  
 PS\* = 1 unit  
 PG = 41B



3RT233.-1N.30



3RT234.-1N.30

Rated data AC-1, $t_i$ : 40/60 °C Operational current $I_e$ up to 690 V	Auxiliary contacts		Rated control supply voltage $U_c$ 50/60 Hz AC or DC	Screw terminals 		Spring-loaded terminals 	
	Ident. No.	Version		Article No.	Price per PU	Article No.	Price per PU
A		 	V				

#### For screw fixing and snap-on mounting on TH 35 DIN rail

##### Size S2

With integrated coil circuit  
 (varistor integrated in electronics at the factory)

60/55	11	1	1	20 ... 33 175 ... 280	3RT2336-1NB30 3RT2336-1NP30	--	--
110/95	11	1	1	20 ... 33 175 ... 280	3RT2337-1NB30 3RT2337-1NP30	--	--

#### For screw fixing and snap-on mounting on TH 35-15 and TH 75-15 DIN rails

##### Size S3

With integrated coil circuit  
 (varistor integrated in electronics at the factory)

110/100	11	1	1	20 ... 33 175 ... 280	3RT2344-1NB30 3RT2344-1NP30	--	--
140/130	11	1	1	20 ... 33 175 ... 280	3RT2346-1NB30 3RT2346-1NP30	--	--
160/140	11	1	1	20 ... 33 175 ... 280	3RT2348-1NB30 3RT2348-1NP30	--	--

Other voltages [according to page 4/52](#) on request.

Accessories and spare parts, [see page 3/71](#) onwards.

# Switching devices – Contactors and contactor assemblies – Special applications

## Contactors for special applications

### SIRIUS 3RT.3 contactors, 4-pole, up to 525 A

#### AC/DC operation

Version for AC-3 motor loads





PU (UNIT, SET, M) = 1  
 PS\* = 1 unit  
 PG = 41B



3RT2336-1NB30-4AA0



3RT2346-1NB30-4AA0

<b>Rated data</b> AC-3/AC-3e, $t_f$ : up to 60 °C  Operational current $I_e$ up to 400 V  A	AC-1, $t_f$ : 40/60 °C  Operational current $I_e$ up to 690 V  A	<b>Auxiliary contacts</b> Ident. No.    Version		Rated control supply voltage $U_s$ 50/60 Hz AC or DC	<b>Screw terminals</b> 		<b>Spring-loaded terminals</b> 	
						Article No.	Price per PU	Article No.

#### For screw fixing and snap-on mounting on TH 35 DIN rail

##### Size S2

With integrated coil circuit  
 (varistor integrated in electronics at the factory)

50      60/55      11      1      1      20 ... 33

3RT2336-1NB30-4AA0

--

#### For screw fixing and snap-on mounting on TH 35-15 and TH 75-15 DIN rails

##### Size S3

With integrated coil circuit  
 (varistor integrated in electronics at the factory)

95      110/100      11      1      1      20 ... 33

3RT2346-1NB30-4AA0

--

Other voltages according to page 4/52 on request.

Accessories and spare parts, see page 3/71 onwards.

## Switching devices – Contactors and contactor assemblies – Special applications

### Contactors for special applications

#### SIRIUS 3RT.3 contactors, 4-pole, up to 525 A

##### Sizes S6 to S12: AC/DC operation

- Solid-state operating mechanism
- Version with two laterally mounted auxiliary switches (2 NO + 2 NC each)
- For screw fixing
- Auxiliary and control circuits: Screw terminals
- Main conductors: Busbar connections; a connection kit is enclosed.





3RT1355-6A.36



3RT1363-6A.36



3RT1373-6A.36

Size	Rated data AC-1, $t_{ij}$ : 40 °C	Auxiliary contacts, lateral	Operating range 0.85 ... 1.1 x $U_s$	0.8 ... 1.1 x $U_s$	Busbar connections 	PU (UNIT, SET, M)	PS*	PG
	Operational current $I_e$ at 690 V	Version  	Rated control supply voltage $U_s$ 50/60 Hz AC	DC	Article No.	Price per PU		
A		NO NC	V	V				

#### Solid-state operating mechanism

##### With integrated coil circuit (varistor integrated in electronics at the factory)

<b>S6</b>	200	2	2	24 ... 60	20 ... 60	<b>3RT1355-6AE36</b>	1	1 unit	41B	
				48 ... 130	48 ... 130					<b>3RT1355-6AF36</b>
				100 ... 250	100 ... 250					<b>3RT1355-6AP36</b>
				250 ... 500	250 ... 500					<b>3RT1355-6AR36</b>
<b>S10</b>	275	2	2	24 ... 60	20 ... 60	<b>3RT1363-6AE36</b>	1	1 unit	41B	
				48 ... 130	48 ... 130					<b>3RT1363-6AF36</b>
				100 ... 250	100 ... 250					<b>3RT1363-6AP36</b>
				250 ... 500	250 ... 500					<b>3RT1363-6AR36</b>
	350	2	2	24 ... 60	20 ... 60	<b>3RT1364-6AE36</b>	1	1 unit	41B	
				48 ... 130	48 ... 130					<b>3RT1364-6AF36</b>
				100 ... 250	100 ... 250					<b>3RT1364-6AP36</b>
				250 ... 500	250 ... 500					<b>3RT1364-6AR36</b>
<b>S12</b>	400	2	2	24 ... 60	20 ... 60	<b>3RT1373-6AE36</b>	1	1 unit	41B	
				48 ... 130	48 ... 130					<b>3RT1373-6AF36</b>
				100 ... 250	100 ... 250					<b>3RT1373-6AP36</b>
				250 ... 500	250 ... 500					<b>3RT1373-6AR36</b>
	500	2	2	24 ... 60	20 ... 60	<b>3RT1374-6AE36</b>	1	1 unit	41B	
				48 ... 130	48 ... 130					<b>3RT1374-6AF36</b>
				100 ... 250	100 ... 250					<b>3RT1374-6AP36</b>
				250 ... 500	250 ... 500					<b>3RT1374-6AR36</b>
	525	2	2	24 ... 60	20 ... 60	<b>3RT1375-6AE36</b>	1	1 unit	41B	
				48 ... 130	48 ... 130					<b>3RT1375-6AF36</b>
				100 ... 250	100 ... 250					<b>3RT1375-6AP36</b>
				250 ... 500	250 ... 500					<b>3RT1375-6AR36</b>

Depending on the operational current, bus connectors offset must be used for sizes S10 and S12, [see page 4/35](#):

- 3RT136: For more than 275 A, the 3RT1966-4D bus connectors offset must be used.
- 3RT137: For more than 450 A, the 3RT1976-4D bus connectors offset must be used.

Accessories and spare parts, [see page 4/35 onwards](#).



# Switching devices – Contactors and contactor assemblies – Special applications

## Contactors for special applications







SIRIUS 3RT.3 contactors, 4-pole, up to 525 A

### Accessories

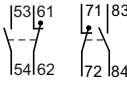

Overview graphic for 3RT135 to 3RT137 contactors with mountable accessories, [see page 4/23](#).

#### More information

Equipment Manual, [see https://support.industry.siemens.com/cs/ww/en/view/60306557](#)

For contactors	Auxiliary contacts Version		Left		Right		Article No.	Price per PU	PU (UNIT, SET, M)	PS*	PG
	Type	NO	NC								
<b>Second auxiliary switch (1 NO + 1 NC)</b>											
Lateral mounting on the right and/or the left, 2-pole											
	3RT135 ... 3RT137	1	1				<b>3RH1951-1SA11</b>		1	1 unit	41B
<b>Terminal covers</b>											
Two units required per contactor (1 set = 2 units) Either bus connectors offset or terminal covers can be used.											
	3RT135	--	--	--	--		<b>3RT1956-4EB10</b>		1	1 unit	41B
	3RT136	--	--	--	--		<b>3RT1966-4EB10</b>		1	1 unit	41B
	3RT137	--	--	--	--		<b>3RT1976-4EB10</b>		1	1 unit	41B
<b>Bus connectors offsets</b>											
(Two units required per contactor) Either terminal covers or bus connectors offset can be used.											
	3RT136	--	--	--	--		<b>3RT1966-4D</b>		1	1 unit	41B
	3RT137	--	--	--	--		<b>3RT1976-4D</b>		1	1 unit	41B
<b>Mechanical interlocks for contactor assemblies</b>											
Enables two 3RT13 contactors of the same size (S6, S10 and S12) to be interlocked with each other. The laterally mounted auxiliary switches of the contactor must be removed beforehand. The mechanical interlock cannot be used in conjunction with the bus connectors offset.											
	3RT135 ... 3RT137	--	--	--	--		<b>3RA1954-3A</b>		1	1 unit	41B

### Spare parts

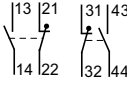
For contactors	Auxiliary contacts Version		Left		Right		Screw terminals 	Price per PU	PU (UNIT, SET, M)	PS*	PG
	Type	NO	NC								
<b>First auxiliary switch (1 NO + 1 NC)</b>											
Lateral mounting on the right and/or the left, 2-pole											
	3RT135 ... 3RT137	1	1				<b>3RH1951-1TA11</b>		1	1 unit	41B

\* You can order this quantity or a multiple thereof.  
Illustrations are approximate

## Switching devices – Contactors and contactor assemblies – Special applications

### Contactors for special applications

#### SIRIUS 3RT25 contactors, 4-pole, 2 NO + 2 NC

##### Overview

###### Standards

IEC 60947-1, IEC 60947-4-1, IEC 60947-5-1 (auxiliary switches)

###### Protecting connections against short circuit, overload and overvoltage

All connections must generally be protected against overload and short circuits using suitable measures. Different constraints must be considered depending on the type of connection:

###### Short-circuit and overload protection of main connections

For information on the protection of a free-standing contactor, see the [technical product data sheet](#).

For more information on device combinations such as contactor with overload relay or contactor with circuit breaker as motor feeder, refer to

- [Digital Configuration Manual for load feeders](#)
- [Configuration Manual for load feeders](#)

###### Short-circuit and overload protection of auxiliary connections

For information on the protection of auxiliary contacts, see the [technical product data sheet](#).

###### Short-circuit and overload protection of control supply voltage or supply voltage connections

First of all, the relevant standards and regulations for configuring control panels and the parts and components installed in them must be taken into account, for example for cable dimensioning.

One possible protection for these circuits could be the selection of a suitable power supply, i.e. one with a current-limiting function. In the selection of the source and the connecting cable, the load characteristics of the contactor must be considered (short-time inrush current peaks for solid-state contactor operating mechanisms, switch-on power, holding power). The same applies to the selection of suitable protection devices.

If there are further switching elements in the circuit, such as the auxiliary contact system of an overload relay that operates the contactor, the short-circuit protection necessary for this must also be considered.

For further recommendations, e.g. the use of miniature circuit breakers or circuit breakers for equipment in control circuits, see [Control panel tip – Selecting and dimensioning suitable power supplies quickly and reliably](#).

###### Protection against overvoltage at the control supply voltage connection

3RT25 contactors supplied without a coil circuit can be retrofitted with RC elements, varistors, diodes or diode assemblies (combination of diode and Zener diode for short break times) for damping switching overvoltages in the coil and can be ordered separately as accessories, see [page 3/102 onwards](#).

###### Note:

The break times of the contactor, the opening delay times of the NO contacts and the closing delay times of the NC contacts increase in the event of damping.

For more information about influencing the time response using damping, see [Equipment Manual](#).

###### Replacing solenoid coils or spare contacts

Solenoid coil or contact replacement is possible.

###### Fitting auxiliary contacts and mounting additional auxiliary switches

###### Features in the delivery state

The basic units 3RT252 to 3RT254 contain two integrated auxiliary contacts (1 NO + 1 NC).

###### Expansion possibilities

All basic units can be expanded using auxiliary switches; the permissible configuration must be observed.

For detailed information about the fitting of auxiliary switches for 3RT25 contactors, see [pages 3/83 to 3/90](#).

###### Accessories

The accessories for the 3-pole SIRIUS 3RT2 contactors can also be used for the 4-pole versions, see [page 3/71 onwards](#).

###### Use of 3RT contactors with IE3 and IE4 motors

###### Note:

For the use of 3RT25 contactors in conjunction with high-efficiency IE3 and IE4 motors, please observe the information on dimensioning and configuring, see [Application Manual](#).

For more information, see [page 1/8](#).

##### Application

The contactors are suitable:

- For changing the polarity of hoisting gear motors
- For switching two separate loads

###### Note:

Single device for pole reversal; not suitable for reversing operation. 3RT25 contactors are not suitable for switching a load between two current sources.

# Switching devices – Contactors and contactor assemblies – Special applications

## Contactors for special applications

### SIRIUS 3RT25 contactors, 4-pole, 2 NO + 2 NC

#### Technical specifications

##### More information

Technical specifications, see  
<https://support.industry.siemens.com/cs/ww/en/ps/16169/td>  
 FAQs, see <https://support.industry.siemens.com/cs/ww/en/ps/16169/faq>

Manuals, see  
<https://support.industry.siemens.com/cs/ww/en/ps/16169/man>

Type	<b>3RT2516 to 3RT2518</b>	<b>3RT2526</b>	<b>3RT2535</b>	<b>3RT2536</b>	<b>3RT2544, 3RT2545</b>
Size	<b>S00</b>	<b>S0</b>	<b>S2</b>	<b>S3</b>	<b>S3</b>

##### General data

<b>Dimensions (W x H x D)</b>	See 3RT231., page 4/24	See 3RT232., page 4/24	See 3RT233., page 4/24	See 3RT234., page 4/24
-------------------------------	---------------------------	---------------------------	---------------------------	---------------------------

##### Permissible mounting position

The contactors are designed for operation on a vertical mounting surface.

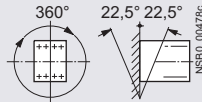

##### Upright mounting position



Special version required

<b>Mechanical endurance</b>	Operating cycles	30 million	10 million
<b>Electrical endurance at <math>I_e/AC-1</math></b>	Operating cycles	Approx. 0.5 million	
<b>Rated insulation voltage <math>U_i</math></b> (pollution degree 3)	V	690	
<b>Protective separation</b> between the coil and the main contacts according to IEC 60947-1, Annex N	V	400	690
<b>Permissible ambient temperature</b>			
• During operation	°C	-25 ... +60	
• During storage	°C	-55 ... +80	

##### Short-circuit protection

###### Main circuit

• Version of the fuse link required for short-circuit protection of the main circuit

- For type of coordination 1

gG: 35 A (690 V, 100 kA)	gG: 63 A (690 V, 100 kA)	gG: 125 A (690 V, 100 kA)	gG: 160 A (690 V, 100 kA)	gG: 250 A (690 V, 100 kA)
-----------------------------	-----------------------------	---------------------------------	---------------------------------	------------------------------

- For type of coordination 2

gG: 20 A (690 V, 100 kA)	gG: 35 A (690 V, 50 kA)	gG: 63 A (690 V, 100 kA)	gG: 80 A (690 V, 100 kA)	gR: 250 A (690 V, 100 kA)
-----------------------------	----------------------------	--------------------------------	--------------------------------	------------------------------

###### Auxiliary circuit

• Version of the fuse link required for short-circuit protection of the auxiliary switch

Fuse gG: 10 A (690 V, 1 kA)

• Version of the miniature circuit breaker required for short-circuit protection of the auxiliary switch

6 A (230 V, 400 A, C characteristic)

## Switching devices – Contactors and contactor assemblies – Special applications

### Contactors for special applications

#### SIRIUS 3RT25 contactors, 4-pole, 2 NO + 2 NC

Type	3RT2516-1A	3RT2517-1A, 3RT2518-1A	3RT2516-1B, 3RT2517-1B, 3RT2518-1B	3RT2526-1A	3RT2526-1B	3RT253-1A	3RT253-1N	3RT254-1A	3RT254-1N	
Size	S00			S0		S2		S3		
<b>Control</b>										
<b>Type of operating mechanism</b>	AC		DC	AC	DC	AC	AC/DC	AC	AC/DC	
<b>Solenoid coil operating range</b>										
• AC operation	At 50 Hz	0.8 ... 1.1 x $U_s$	--	0.8 ... 1.1 x $U_s$	--	0.8 ... 1.1 x $U_s$	--	0.8 ... 1.1 x $U_s$	--	
	At 60 Hz	0.85 ... 1.1 x $U_s$	--	0.8 ... 1.1 x $U_s$	--	0.8 ... 1.1 x $U_s$	--	0.8 ... 1.1 x $U_s$	--	
• DC operation	Up to 50 °C	--	0.8 ... 1.1 x $U_s$	--	0.8 ... 1.1 x $U_s$	--	--	--	--	
	Up to 60 °C	--	0.85 ... 1.1 x $U_s$	--	0.8 ... 1.1 x $U_s$	--	--	--	--	
• AC/DC operation		--	--	--	--	--	0.8 x $U_{s\ min}$ ... 1.1 x $U_{s\ max}$	--	0.8 x $U_{s\ min}$ ... 1.1 x $U_{s\ max}$	
<b>Power consumption of the solenoid coils</b> (for cold coil and 1.0 x $U_s$ )										
• AC operation, 50/60 Hz, standard version										
- Closing	VA	27/24.3	37/33	--	81/79	--	210/188	110	348/296	--
- P.f.		0.8/0.75	--	--	0.72/0.74	--	0.69/0.65	0.95	0.62/0.55	--
- Closed	VA	4.2/3.3	5.7/4.4	--	10.5/8.5	--	17.2/16.5	2.5	25/18	--
- P.f.		0.25/0.25	--	--	0.25/0.28	--	0.36/0.39	0.95	0.35/0.41	--
• DC operation										
- Closing	W	--	4	--	5.9	23	70	--	76	
- Closed	W	--	4	--	5.9	1	1.5	--	1.8	

Type	3RT2516	3RT2517	3RT2518	3RT2526	3RT2535	3RT2536	3RT2544	3RT2545	
Size	S00			S0	S2		S3		
<b>Rated data of the main contacts</b>									
<b>Load rating with AC</b>									
<b>Utilization category AC-1</b>									
• Rated operational currents $I_e$	At 40 °C up to 690 V	A	18	22	40	60	70	100	125
	At 60 °C up to 690 V	A	16	20	35	55	60	90	105
• Rated power for AC loads	at 230 V	kW	6	7.5	13.3	21	23	34	59
P.f. = 0.95 (at 60 °C)	400 V	kW	10.5	13	23	36	39	40	69
• Minimum cross-section in the main circuit at maximum AC-1 rated value		mm <sup>2</sup>	2.5	4	10	16	25	35	50
<b>Utilization category AC-3</b>									
• Rated operational currents $I_e$ (at 60 °C)	NO up to 400 V	A	9	12	16	25	35	41	65
	NC up to 400 V	A	9			25	20	35	41
• Rated power for slip-ring or squirrel-cage motors at 50 and 60 Hz	NO at 230 V	kW	2.2	3	4	5.5	11		18.5
	NC at 230 V	kW	2.2			5.5	11		18.5
	NO at 400 V	kW	4	5.5	7.5	11	18.5	22	30
	NC at 400 V	kW	4			11	7.5	18.5	22

<sup>1)</sup> Values for devices with AC and DC operation: For 3RT2526 with DC operation, different values apply to AC-3 for the NC.

# Switching devices – Contactors and contactor assemblies – Special applications

## Contactors for special applications

### SIRIUS 3RT25 contactors, 4-pole, 2 NO + 2 NC

#### Selection and ordering data

##### AC operation

Single device for pole reversal (not suitable for reversing operation)

PU (UNIT, SET, M) = 1  
 PS\* = 1 unit  
 PG = 41B

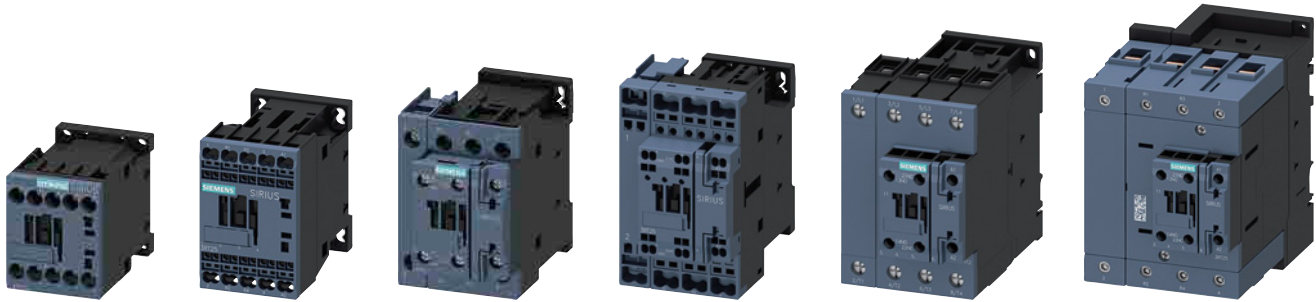

3RT251.-1A.00



3RT251.-2A.00

3RT252.-1A.00

3RT252.-2A.00

3RT253.-1A.00

3RT254.-1A.00

Rated data		Auxiliary contacts		Rated control supply voltage $U_s$		Screw terminals 		Spring-loaded terminals 			
AC-3, $t_f$ : up to 60 °C		AC-1, $t_f$ : 40/60 °C		Ident. No.	Version	50/60 Hz AC	50 Hz AC	Article No.	Price per PU	Article No.	Price per PU
Operational current $I_e$ up to 400 V	Ratings of three-phase motors at 50 Hz and <b>400 V</b>	Operational current $I_e$ up to 690 V									
A	kW	A	NO	NC	V	V					

#### For screw fixing and snap-on mounting on TH 35 DIN rail

##### Size S00

9	4	18/16	--	--	--	24	--	3RT2516-1AB00	3RT2516-2AB00
						110	--	3RT2516-1AF00	3RT2516-2AF00
						230	--	3RT2516-1AP00	3RT2516-2AP00
12/9 <sup>1)</sup>	5.5/4 <sup>1)</sup>	22/20	--	--	--	24	--	3RT2517-1AB00	3RT2517-2AB00
						110	--	3RT2517-1AF00	3RT2517-2AF00
						230	--	3RT2517-1AP00	3RT2517-2AP00
16/9 <sup>1)</sup>	7.5/4 <sup>1)</sup>	22/20	--	--	--	24	--	3RT2518-1AB00	3RT2518-2AB00
						110	--	3RT2518-1AF00	3RT2518-2AF00
						230	--	3RT2518-1AP00	3RT2518-2AP00

##### Size S0

25	11	40/35	11	1	1	--	24	3RT2526-1AB00	3RT2526-2AB00
						--	110	3RT2526-1AF00	3RT2526-2AF00
						--	230	3RT2526-1AP00	3RT2526-2AP00

##### Size S2

35	18.5	60/55	11	1	1	--	24	3RT2535-1AB00	--
						--	110	3RT2535-1AF00	--
						--	230	3RT2535-1AP00	--
41	22	70/60	11	1	1	--	24	3RT2536-1AB00	--
						--	110	3RT2536-1AF00	--
						--	230	3RT2536-1AP00	--

#### For screw fixing and snap-on mounting on TH 35-15 and TH 75-15 DIN rails

##### Size S3

65	30	100/90	11	1	1	--	24	3RT2544-1AB00	--
						--	110	3RT2544-1AF00	--
						--	230	3RT2544-1AP00	--
80	37	125/105	11	1	1	--	24	3RT2545-1AB00	--
						--	110	3RT2545-1AF00	--
						--	230	3RT2545-1AP00	--

<sup>1)</sup> Values for NO contact/NC contact. The NC contact can switch no more than 4 kW.

Other voltages according to page 4/52 on request.  
 Accessories and spare parts, see page 3/71 onwards.

## Switching devices – Contactors and contactor assemblies – Special applications

### Contactors for special applications

#### SIRIUS 3RT25 contactors, 4-pole, 2 NO + 2 NC

##### DC operation

Single device for pole reversal (not suitable for reversing operation)

PU (UNIT, SET, M) = 1

PS\* = 1 unit

PG = 41B



3RT251.-1B.40





3RT251.-2B.40



3RT252.-1B.40



3RT252.-2B.40

Rated data		Auxiliary contacts		Rated control supply voltage $U_s$	Screw terminals 	Spring-loaded terminals 
AC-3, $t_d$ : up to 60 °C	AC-1, $t_d$ : 40/60 °C	Ident. No.	Version	DC	Article No.	Article No.
Operational current $I_e$ up to 400 V	Operational current $I_e$ up to 690 V				Price per PU	Price per PU
Ratings of three-phase motors at 50 Hz and <b>400 V</b>			NO NC V			
A	A					

#### For screw fixing and snap-on mounting on TH 35 DIN rail

##### Size S00

9	4	18/16	--	--	--	24 220	<b>3RT2516-1BB40</b> <b>3RT2516-1BM40</b>	<b>3RT2516-2BB40</b> <b>3RT2516-2BM40</b>
12/9 <sup>1)</sup>	<b>5.5/4<sup>1)</sup></b>	22/20	--	--	--	24 220	<b>3RT2517-1BB40</b> <b>3RT2517-1BM40</b>	<b>3RT2517-2BB40</b> <b>3RT2517-2BM40</b>
16/9 <sup>1)</sup>	<b>7.5/4<sup>1)</sup></b>	22/20	--	--	--	24 220	<b>3RT2518-1BB40</b> <b>3RT2518-1BM40</b>	<b>3RT2518-2BB40</b> <b>3RT2518-2BM40</b>

##### Size S0

25 (20) <sup>2)</sup>	<b>11 (7.5)<sup>2)</sup></b>	40/35	11	1	1	24 220	<b>3RT2526-1BB40</b> <b>3RT2526-1BM40</b>	<b>3RT2526-2BB40</b> <b>3RT2526-2BM40</b>
-----------------------	------------------------------	-------	----	---	---	-----------	--	--

<sup>1)</sup> Values for NO contact/NC contact. The NC contact can switch no more than 4 kW.

<sup>2)</sup> Value in brackets for NC contact (the deviating value for the NC contact applies only for devices with DC operation).

Other voltages according to page 4/52 on request.

Accessories and spare parts, see page 3/71 onwards.



## Switching devices – Contactors and contactor assemblies – Special applications

### Contactors for special applications

#### SIRIUS 3RT25 contactors, 4-pole, 2 NO + 2 NC

#### AC/DC operation

Single device for pole reversal (not suitable for reversing operation)



PU (UNIT, SET, M) = 1  
 PS\* = 1 unit  
 PG = 41B



3RT253.-1N.30



3RT254.-1N.30

Rated data		Auxiliary contacts		Rated control supply voltage $U_s$	Screw terminals 	Spring-loaded terminals 
AC-3, $t_{ij}$ : up to 60 °C	AC-1, $t_{ij}$ : 40/60 °C	Ident. No.	Version	50/60 Hz AC or DC	Article No.	Article No.
Operational current $I_e$ up to 400 V	Operational current $I_e$ up to 690 V				Price per PU	Price per PU
A	A		NO NC V			

#### For screw fixing and snap-on mounting on TH 35 DIN rail

##### Size S2

With integrated coil circuit (varistor integrated in electronics at the factory)

35	18.5	60/55	11	1	1	20 ... 33 83 ... 155 175 ... 280	3RT2535-1NB30 3RT2535-1NF30 3RT2535-1NP30	-- -- --
41	22	70/60	11	1	1	20 ... 33 83 ... 155 175 ... 280	3RT2536-1NB30 3RT2536-1NF30 3RT2536-1NP30	-- -- --

#### For screw fixing and snap-on mounting on TH 35-15 and TH 75-15 DIN rails

##### Size S3

With integrated coil circuit (varistor integrated in electronics at the factory)

65	30	100/90	11	1	1	20 ... 33 175 ... 280	3RT2544-1NB30 3RT2544-1NP30	-- --
80	37	125/105	11	1	1	20 ... 33 175 ... 280	3RT2545-1NB30 3RT2545-1NP30	-- --

Other voltages [according to page 4/52](#) on request.

Accessories and spare parts, [see page 3/71 onwards](#).

## Switching devices – Contactors and contactor assemblies – Special applications

### Contactors for special applications

#### SIRIUS 3RT26 contactors for capacitive loads (AC-6b), 3-pole

##### Overview

##### Standards

IEC 60947-1, IEC 60947-4-1, IEC 60947-5-1, IEC 60831-1, IEC 61921

##### Function

The 3RT26 contactors are special versions of the 3RT2, designed for switching capacitive loads (AC-6b) up to 100 kvar at 400 V.

Characteristic components of the 3RT26 contactors are the precharging resistors switched on via leading auxiliary contacts, which are closed before the main contacts. This limits the peak charging current of capacitive loads and thus minimizes negative impacts on the power supply network.

The 3RT26 contactors are suitable for switching choked or unchoked capacitors in reactive current compensation systems and are also used to switch converters.

##### Protecting connections against short circuit, overload and overvoltage

All connections must generally be protected against overload and short circuits using suitable measures. Different constraints must be considered depending on the type of connection:

##### Short-circuit and overload protection of main connections

For information on the protection of a free-standing contactor, see the [technical product data sheet](#).

For more information on device combinations such as contactor with overload relay or contactor with circuit breaker as motor feeder, refer to

- [Digital Configuration Manual for load feeders](#)
- [Configuration Manual for load feeders](#)

##### Short-circuit and overload protection of auxiliary connections

For information on the protection of auxiliary contacts, see the [technical product data sheet](#).

##### Short-circuit and overload protection of control supply voltage or supply voltage connections

First of all, the relevant standards and regulations for configuring control panels and the parts and components installed in them must be taken into account, for example for cable dimensioning.

One possible protection for these circuits could be the selection of a suitable power supply, i.e. one with a current-limiting function. In the selection of the source and the connecting cable, the load characteristics of the contactor must be considered (short-time inrush current peaks for solid-state contactor operating mechanisms, switch-on power, holding power). The same applies to the selection of suitable protection devices.

If there are further switching elements in the circuit, such as the auxiliary contact system of an overload relay that operates the contactor, the short-circuit protection necessary for this must also be considered.

For further recommendations, e.g. the use of miniature circuit breakers or circuit breakers for equipment in control circuits, see [Control panel tip – Selecting and dimensioning suitable power supplies quickly and reliably](#).

##### Protection against overvoltage at the control supply voltage connection

3RT26 contactors supplied without a coil circuit can be retrofitted with RC elements, varistors, diodes or diode assemblies (combination of diode and Zener diode for short break times) for damping switching overvoltages in the coil and can be ordered separately as accessories, see [page 3/102 onwards](#).

##### Note:

The break times of the contactor, the opening delay times of the NO contacts and the closing delay times of the NC contacts increase in the event of damping.

For more information about influencing the time response using damping, see [Equipment Manual](#).

##### Fitting auxiliary contacts and mounting additional auxiliary switches

##### Features in the delivery state

- 3RT261 contactors:  
The basic units are equipped with a 4-pole front-mounted auxiliary switch with one freely accessible contact. The other three contacts are assigned to the precharging resistors. The basic unit contains additional free auxiliary contacts (1 NO + 1 NC or 2 NO, depending on the version).
- 3RT262 contactors:  
The basic units are equipped with a 4-pole front-mounted auxiliary switch with one freely accessible contact. The other three contacts are assigned to the precharging resistors. The basic unit contains two additional free auxiliary contacts (1 NO + 1 NC).
- 3RT263 and 3RT264 contactors:  
The auxiliary contacts for the resistors are already integrated in the basic units, which do not have any additional integrated and freely assignable auxiliary contacts. A 2-pole lateral auxiliary switch is already mounted on the left (depending on the version, 1 NO + 1 NC or 2 NC).

##### Expansion possibilities

All 3RT263 and 3RT264 contactors can be expanded using lateral auxiliary switches; the permissible configuration must be observed.

Type	3RT261	3RT262	3RT263, 3RT264
Size	S00	S0	S2, S3
Number of unassigned auxiliary contacts as delivered from the factory	2	3	2
Number of expansion auxiliary contacts that can be fitted	0	0	2

##### Conductor cross-sections

In order to connect the required minimum cross-section, the use of 3RV2935-5A 3-phase infeed terminal may be necessary for 3RT263 contactors and of 3RA2943-3L 1-phase infeed terminal for 3RT264 contactors, see [page 3/116](#). These infeed terminals enable the clamping of larger cross-sections than the device connection itself actually allows.

For 3RT2628 contactors, this infeed terminal is included in the scope of supply and is mounted on the contactor.

# Switching devices – Contactors and contactor assemblies – Special applications

## Contactors for special applications

### SIRIUS 3RT26 contactors for capacitive loads (AC-6b), 3-pole

#### Technical specifications

##### More information

Technical specifications, see  
<https://support.industry.siemens.com/cs/ww/en/ps/16171/td>

Manuals, see  
<https://support.industry.siemens.com/cs/ww/en/ps/16171/man>

Type

**3RT26**

Size

**S00 to S3**

##### Contact endurance of the main contacts

The characteristic curves show the contact endurance of the contactors when switching capacitive loads (AC-6b) depending on the reactive power  $Q_N$  and the rated operational voltage.

The rated operational current  $I_a$  complies with utilization category AC-6b (breaking of 1.35 times the rated operational current) and is intended for a contact endurance of approximately 150 000 to 200 000 operating cycles.

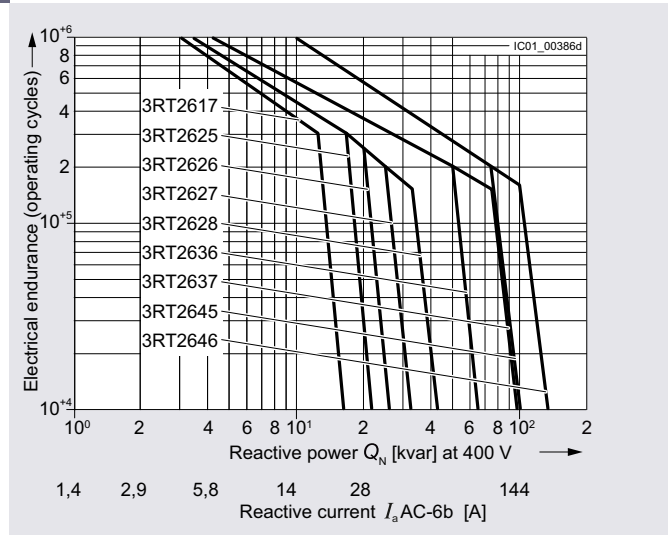

## Switching devices – Contactors and contactor assemblies – Special applications

### Contactors for special applications

#### SIRIUS 3RT26 contactors for capacitive loads (AC-6b), 3-pole

All technical specifications not mentioned in the table below are identical to those of the 3RT20 contactors:

- For size S00 as for the 3RT201 contactors
- For size S0 as for the 3RT202 contactors
- For size S2 as for the 3RT203 contactors
- For size S3 as for the 3RT204 contactors

See page 3/25 onwards.

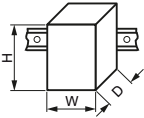
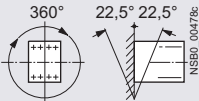
Type		3RT2617	3RT2625	3RT2626	3RT2627	3RT2628	3RT2636	3RT2637	3RT2645	3RT2646
Size		S00	S0				S2		S3	
<b>General data</b>										
<b>Dimensions (W x H x D)</b> including auxiliary switches and connecting cables										
										
• AC operation	mm	45 x 125 x 120	45 x 135 x 155			45 x 150 x 155	65 x 114 x 130		80 x 140 x 152	
• DC operation, AC/DC operation	mm	45 x 125 x 120	45 x 135 x 165			45 x 150 x 165	65 x 114 x 130		80 x 140 x 152	
<b>Permissible mounting position</b>										
The contactors are designed for operation on a vertical mounting surface.										
										
<b>Mechanical endurance</b>										
Basic units with mounted auxiliary switch	Operating cycles	3 million								
<b>Electrical endurance</b>										
For apparent power at 400 V	kvar	12.5	16.7	20	25	33	50	75		100
	Operating cycles	300 000	200 000			150 000	200 000	150 000	200 000	150 000
<b>Rated insulation voltage <math>U_i</math></b> (pollution degree 3)	V	690							1 000 <sup>2)</sup>	
<b>Rated impulse withstand voltage <math>U_{imp}</math></b>	kV	6							8 <sup>2)</sup>	
<b>Protective separation</b> between the coil and the main contacts according to IEC 60947-1, Annex N	V	400							690	
<b>Permissible ambient temperature</b>										
• During operation <sup>1)</sup>	°C	-25 ... +60								
• During storage	°C	-55 ... +80								
<b>Short-circuit protection</b>										
<b>Main circuit</b>										
Fuse links, operating class gG: LV HRC, type 3NA; DIAZED, type 5SB; NEOZED, type 5SE according to IEC 60947-4-1										
• Type of coordination "1"	A	25 ... 40	32 ... 80	40 ... 80	50 ... 100	63 ... 100	100 ... 160	160 ... 200		200 ... 250
<b>Auxiliary circuit</b>										
• With fuse links of operating class gG: DIAZED, type 5SB; NEOZED, type 5SE With short-circuit current $I_k = 1$ kA according to IEC 60947-5-1	A	10								
• With miniature circuit breakers with C characteristic with short-circuit current $I_k = 400$ A	A	10								

<sup>1)</sup> A clearance of 10 mm is required for side-by-side mounting.

<sup>2)</sup> Only applies for main conducting paths, otherwise  $U_i = 690$  V;  $U_{imp} = 6$  kV.

## Switching devices – Contactors and contactor assemblies – Special applications

### Contactors for special applications

#### SIRIUS 3RT26 contactors for capacitive loads (AC-6b), 3-pole

Type		3RT2617-1A, -1B	3RT2625-1A, -1B, 3RT2626-1A, -1B, 3RT2627-1A, -1B, 3RT2628-1A, -1B	3RT2636-1A, 3RT2637-1A	3RT2645-1A, 3RT2646-1A	
Size		S00	S0	S2	S3	
<b>Control</b>						
<b>Solenoid coil operating range</b>						
• AC operation	50 Hz	0.8 ... 1.1 × $U_s$		0.8 ... 1.1 × $U_s$		
	60 Hz	0.85 ... 1.1 × $U_s$				
• DC operation	At 50 °C	0.8 ... 1.1 × $U_s$		--		
	At 60 °C	0.85 ... 1.1 × $U_s$		0.8 ... 1.1 × $U_s$	--	
<b>Power consumption of the solenoid coils</b> (for cold coil and 1.0 × $U_s$ )						
• AC operation, 50 Hz, standard version						
- Closing	VA	--	77	190	296	
- P.f.		--	0.82	0.72	0.61	
- Closed	VA	--	9.8	16	19	
- P.f.		--	0.25	0.37	0.38	
• AC operation, 50/60 Hz, standard version						
- Closing	VA	49	81/79	210/188	348/296	
- P.f.		0.8	0.72/0.74	0.69/0.65	0.62/0.55	
- Closed	VA	7.8	10.5/8.5	17.2/16.5	25/18	
- P.f.		0.25	0.25/0.28	0.36/0.39	0.35/0.41	
• DC operation						
- Closing	W	4	5.9	--	--	
- Closed	W	4	5.9	--	--	
<hr/>						
Type		3RT262.-1NB35	3RT262.-1NF35	3RT262.-1NP35	3RT263.-1N.35	3RT264.-1N.35
Size		S0			S2	S3
<b>Control</b>						
<b>Solenoid coil operating range</b>						
• AC/DC operation (50/60 Hz AC or DC)		0.7 ... 1.3 × $U_s$			0.8 ... 1.1 × $U_s$	
<b>Power consumption of the solenoid coils</b> (for cold coil and 1.0 × $U_s$ )						
• AC operation, 50/60 Hz, standard version						
- Closing	VA	6.6/6.7	11.9/12.0	12.7/14.7	110	163
- P.f.		0.98/0.98			0.95	--
- Closed	VA	1.9/2.0	1.6/1.8	3.9/4.3	2.5	3.1
- P.f.		0.86/0.82	0.79/0.74	0.51/0.56	0.95	--
• DC operation						
- Closing	W	5.9	10.2	14.3	70	76
- Closed	W	1.4	1.3	1.9	1.5	1.8
<b>Maximum permissible residual current of the electronics</b> (with 0 signal)						
• AC operation (230 V/ $U_s$ )	mA	7			< 20	
• DC operation (24 V/ $U_s$ )	mA	16			< 20	

## Switching devices – Contactors and contactor assemblies – Special applications

### Contactors for special applications

#### SIRIUS 3RT26 contactors for capacitive loads (AC-6b), 3-pole

Type	3RT2617	3RT2625	3RT2626	3RT2627	3RT2628	3RT2636	3RT2637	3RT2645	3RT2646																																																																																									
Size	S00	S0				S2		S3																																																																																										
<b>Auxiliary circuit</b>																																																																																																		
<b>Auxiliary contacts</b> (unassigned)	1 NO + 1 NC, 2 NC	1 NO + 2 NC				1 NO + 1 NC, 2 NC																																																																																												
<b>Further auxiliary switches, laterally mountable</b>	--					No more than one lateral auxiliary switch can be mounted																																																																																												
Technical specifications including CSA and UL rated data of the auxiliary contacts, see "3RT20 contactors", page 3/25 onwards.																																																																																																		
<b>Rated data of the main contacts</b>																																																																																																		
<b>Load rating with AC</b>																																																																																																		
<b>Utilization category AC-6b</b>																																																																																																		
<b>Switching of AC capacitors</b>																																																																																																		
<ul style="list-style-type: none"> <li>Rated operational current <math>I_e</math> at AC-6b           <table border="1"> <tr> <td>- Up to 690 V at ambient temperature</td> <td>40 °C A</td> <td>18.9</td> <td>25.3</td> <td>30.2</td> <td>37.8</td> <td>50</td> <td>75.8</td> <td>113.4</td> <td>113</td> <td>151</td> </tr> <tr> <td></td> <td>60 °C A</td> <td>18</td> <td>24</td> <td>29</td> <td>36</td> <td>47.6</td> <td>72.2</td> <td>108</td> <td></td> <td>144</td> </tr> <tr> <td>- Up to 1 000 V at ambient temperature</td> <td>60 °C A</td> <td>--</td> <td></td> <td></td> <td></td> <td></td> <td></td> <td></td> <td>54</td> <td>68</td> </tr> </table> </li> <li>Rated operational reactive power at rated operational voltage           <table border="1"> <tr> <td>230 V, 50/60 Hz kvar</td> <td>7.2</td> <td>9.6</td> <td>11.5</td> <td>14</td> <td>19</td> <td>29</td> <td>43</td> <td></td> <td></td> <td>57</td> </tr> <tr> <td><b>400 V, 50/60 Hz kvar</b></td> <td><b>12.5</b></td> <td><b>16.7</b></td> <td><b>20</b></td> <td><b>25</b></td> <td><b>33</b></td> <td><b>50</b></td> <td><b>75</b></td> <td></td> <td></td> <td><b>100</b></td> </tr> <tr> <td>500 V, 50/60 Hz kvar</td> <td>15</td> <td>21</td> <td>25</td> <td>31</td> <td>41</td> <td>63</td> <td>94</td> <td></td> <td></td> <td>125</td> </tr> <tr> <td>690 V, 50/60 Hz kvar</td> <td>21</td> <td>29</td> <td>34</td> <td>43</td> <td>57</td> <td>86</td> <td>129</td> <td></td> <td></td> <td>172</td> </tr> <tr> <td>1 000 V, 50/60 Hz kvar</td> <td>--</td> <td></td> <td></td> <td></td> <td></td> <td></td> <td></td> <td>94</td> <td></td> <td>125</td> </tr> </table> </li> <li>Minimum cross-section in the main circuit for max. AC-6b rated value           <ul style="list-style-type: none"> <li>See</li> <li>Product data sheets of the relevant capacitor contactors and capacitors</li> <li>Operating instructions and manuals, <a href="https://support.industry.siemens.com/cs/ww/en/ps/16171/man">https://support.industry.siemens.com/cs/ww/en/ps/16171/man</a></li> </ul> </li> </ul>											- Up to 690 V at ambient temperature	40 °C A	18.9	25.3	30.2	37.8	50	75.8	113.4	113	151		60 °C A	18	24	29	36	47.6	72.2	108		144	- Up to 1 000 V at ambient temperature	60 °C A	--							54	68	230 V, 50/60 Hz kvar	7.2	9.6	11.5	14	19	29	43			57	<b>400 V, 50/60 Hz kvar</b>	<b>12.5</b>	<b>16.7</b>	<b>20</b>	<b>25</b>	<b>33</b>	<b>50</b>	<b>75</b>			<b>100</b>	500 V, 50/60 Hz kvar	15	21	25	31	41	63	94			125	690 V, 50/60 Hz kvar	21	29	34	43	57	86	129			172	1 000 V, 50/60 Hz kvar	--							94		125
- Up to 690 V at ambient temperature	40 °C A	18.9	25.3	30.2	37.8	50	75.8	113.4	113	151																																																																																								
	60 °C A	18	24	29	36	47.6	72.2	108		144																																																																																								
- Up to 1 000 V at ambient temperature	60 °C A	--							54	68																																																																																								
230 V, 50/60 Hz kvar	7.2	9.6	11.5	14	19	29	43			57																																																																																								
<b>400 V, 50/60 Hz kvar</b>	<b>12.5</b>	<b>16.7</b>	<b>20</b>	<b>25</b>	<b>33</b>	<b>50</b>	<b>75</b>			<b>100</b>																																																																																								
500 V, 50/60 Hz kvar	15	21	25	31	41	63	94			125																																																																																								
690 V, 50/60 Hz kvar	21	29	34	43	57	86	129			172																																																																																								
1 000 V, 50/60 Hz kvar	--							94		125																																																																																								
<b>Ⓢ and Ⓞ rated data</b>																																																																																																		
<b>Rated insulation voltage</b>	V AC	600																																																																																																
<b>Operational reactive power at AC-6b, 3-phase, at operational voltage</b>	110 ... 120 V kvar	3.4	4.6	5.5	6.3	8.3	14	19	20	25																																																																																								
	200 ... 208 V kvar	6.2	8.3	10	11	15	25	34	37	45																																																																																								
	220 ... 230 V kvar	6.9	9.2	11	13	17	27	38	41	50																																																																																								
	460 ... 480 V kvar	14	18	22	25	33	55	75	82	100																																																																																								
	575 ... 600 V kvar	17	23	27	31	41	69	94	103	125																																																																																								
<b>Short-circuit protection</b>	At 600 V kA	5				10																																																																																												
<b>Fuse for main circuit</b>	Class RK5 A	40	80			100		250																																																																																										



## Switching devices – Contactors and contactor assemblies – Special applications

### Contactors for special applications

#### SIRIUS 3RT26 contactors for capacitive loads (AC-6b), 3-pole

Type		3RT2617	3RT2625, 3RT2626, 3RT2627	3RT2628	3RT2636	3RT2637	3RT2645, 3RT2646
Size		S00	S0		S2		S3
<b>Conductor cross-sections</b>							
<b>Main conductors</b> (1 or 2 conductors can be connected)		 <b>Screw terminals</b>					
• Solid or stranded	mm <sup>2</sup>	2 x (0.5 ... 1.5) <sup>1)</sup> ; 2 x (0.75 ... 2.5) <sup>1)</sup> ; max. 2 x 4	2 x (1 ... 2.5) <sup>1)</sup> ; 2 x (2.5 ... 10) <sup>1)</sup>		2 x (2.5 ... 35); 1 x (2.5 ... 50)		2 x (10 ... 70); 1 x (10 ... 70)
• Finely stranded with end sleeve (DIN 46228)	mm <sup>2</sup>	2 x (0.5 ... 1.5) <sup>1)</sup> ; 2 x (0.75 ... 2.5) <sup>1)</sup>	2 x (1 ... 2.5) <sup>1)</sup> ; 2 x (2.5 ... 6) <sup>1)</sup> ; 1 x 10	1 x (2.5 ... 16)	2 x (1 ... 25); 1 x (1 ... 35)	--	2 x (10 ... 50); 1 x (10 ... 50)
• AWG cables, solid or stranded	AWG	2 x (20 ... 16) <sup>1)</sup> ; 2 x (18 ... 14) <sup>1)</sup> ; 2 x 12	2 x (16 ... 12) <sup>1)</sup> ; 2 x (14 ... 8) <sup>1)</sup>	1 x (10 ... 4)	2 x (18 ... 2); 1 x (18 ... 0)		2 x (8 ... 3/0); 1 x (8 ... 3/0)
• Terminal screw		M3 (for Pozidriv size 2; Ø 5 ... 6 mm)	M4 (for Pozidriv size 2; Ø 5 ... 6 mm)	M8	M6 (for Pozidriv size 2; Ø 5 ... 6 mm)		M8 (hexagon socket, A/F 4)
• Tightening torque	Nm lb.in	0.8 ... 1.2 7 ... 10.3	2 ... 2.5 18 ... 22	3 ... 4 27 ... 36	3 ... 4.5 27 ... 40		4.5 ... 6 40 ... 53
<b>Auxiliary conductors</b> (1 or 2 conductors can be connected)							
• Solid or stranded	mm <sup>2</sup>	2 x (0.5 ... 1.5) <sup>1)</sup> ; 2 x (0.75 ... 2.5) <sup>1)</sup> ; max. 2 x 4					
• Finely stranded with end sleeve (DIN 46228)	mm <sup>2</sup>	2 x (0.5 ... 1.5) <sup>1)</sup> ; 2 x (0.75 ... 2.5) <sup>1)</sup>					
• AWG cables, solid or stranded	AWG	2 x (20 ... 16) <sup>1)</sup> ; 2 x (18 ... 14) <sup>1)</sup> ; 2 x 12					
• Terminal screw		M3 (for Pozidriv size 2; Ø 5 ... 6 mm)					
• Tightening torque	Nm lb.in	0.8 ... 1.2 7 ... 10.3					

<sup>1)</sup> If two different conductor cross-sections are connected to one clamping point, both cross-sections must lie in one of the ranges specified.

# Switching devices – Contactors and contactor assemblies – Special applications

## Contactors for special applications

### SIRIUS 3RT26 contactors for capacitive loads (AC-6b), 3-pole

#### Selection and ordering data

##### AC operation

Main, auxiliary and control conductors: Screw terminals



3RT2617-1A.05

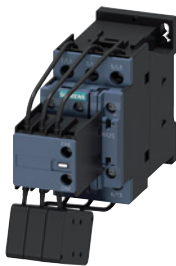

3RT262-1A.05

3RT2628-1A.05  
with infeed terminal

#### Utilization category AC-6b

Switching AC capacitors  
at an ambient temperature of 60 °C

Capacitor rating at  
operational voltage 50/60 Hz  
at 230 V at **400 V** at 500 V at 690 V

kvar **kvar** kvar kvar

Auxiliary  
contacts,  
unassigned

Version

NO NC

Rated control supply  
voltage  $U_s$

50 Hz AC 50/60 Hz AC

V V

#### Screw terminals

PU  
(UNIT,  
SET, M)

PS\*

PG

Article No.

Price  
per PU

#### For screw fixing and snap-on mounting on TH 35 DIN rail

##### Size S00

7.2	<b>12.5</b>	15	21	1	1	--	24	<b>3RT2617-1AB03</b>	1	1 unit	41B
							110	<b>3RT2617-1AF03</b>	1	1 unit	41B
							230	<b>3RT2617-1AP03</b>	1	1 unit	41B
7.2	<b>12.5</b>	15	21	0	2	--	24	<b>3RT2617-1AB05</b>	1	1 unit	41B
							110	<b>3RT2617-1AF05</b>	1	1 unit	41B
							230	<b>3RT2617-1AP05</b>	1	1 unit	41B

##### Size S0

9.6	<b>16.7</b>	21	29	1	2	24	--	<b>3RT2625-1AB05</b>	1	1 unit	41B
						110	--	<b>3RT2625-1AF05</b>	1	1 unit	41B
						230	--	<b>3RT2625-1AP05</b>	1	1 unit	41B
11.5	<b>20</b>	25	34	1	2	24	--	<b>3RT2626-1AB05</b>	1	1 unit	41B
						110	--	<b>3RT2626-1AF05</b>	1	1 unit	41B
						230	--	<b>3RT2626-1AP05</b>	1	1 unit	41B
14	<b>25</b>	31	43	1	2	24	--	<b>3RT2627-1AB05</b>	1	1 unit	41B
						110	--	<b>3RT2627-1AF05</b>	1	1 unit	41B
						230	--	<b>3RT2627-1AP05</b>	1	1 unit	41B
19	<b>33</b>	41	57	1	2	24	--	<b>3RT2628-1AB05</b>	1	1 unit	41B
						110	--	<b>3RT2628-1AF05</b>	1	1 unit	41B
						230	--	<b>3RT2628-1AP05</b>	1	1 unit	41B

Other voltages according to page 4/52 on request.

Accessories and spare parts, see page 3/71 onwards.

## Switching devices – Contactors and contactor assemblies – Special applications

### Contactors for special applications

#### SIRIUS 3RT26 contactors for capacitive loads (AC-6b), 3-pole

#### AC operation

Main, auxiliary and control conductors: Screw terminals



3RT263.-1A.05



3RT264.-1A.05

Utilization category AC-6b				Auxiliary contacts, unassigned			Rated control supply voltage $U_s$	Screw terminals 	PU (UNIT, SET, M)	PS*	PG
Switching AC capacitors at an ambient temperature of 60 °C				Version			50 Hz AC				
Capacitor rating at operational voltage 50/60 Hz				Version			Article No.	Price per PU			
at 230 V	at 400 V	at 500 V	at 690 V	NO	NC	V					
kvar	kvar	kvar	kvar								
<b>For screw fixing and snap-on mounting on TH 35 DIN rail</b>											
<b>Size S2</b>											
29	50	63	86	1	1	24 110 230	3RT2636-1AB03 3RT2636-1AF03 3RT2636-1AP03	1 1 1	1 unit 1 unit 1 unit	41B 41B 41B	
29	50	63	86	0	2	24 110 230	3RT2636-1AB05 3RT2636-1AF05 3RT2636-1AP05	1 1 1	1 unit 1 unit 1 unit	41B 41B 41B	
43	75	94	129	1	1	24 110 230	3RT2637-1AB03 3RT2637-1AF03 3RT2637-1AP03	1 1 1	1 unit 1 unit 1 unit	41B 41B 41B	
43	75	94	129	0	2	24 110 230	3RT2637-1AB05 3RT2637-1AF05 3RT2637-1AP05	1 1 1	1 unit 1 unit 1 unit	41B 41B 41B	
<b>For screw fixing and snap-on mounting on TH 35-15 and TH 75-15 DIN rails</b>											
<b>Size S3</b>											
43	75	94	129	1	1	24 110 230	3RT2645-1AB03 3RT2645-1AF03 3RT2645-1AP03	1 1 1	1 unit 1 unit 1 unit	41B 41B 41B	
43	75	94	129	0	2	24 110 230	3RT2645-1AB05 3RT2645-1AF05 3RT2645-1AP05	1 1 1	1 unit 1 unit 1 unit	41B 41B 41B	
57	100	125	172	1	1	24 110 230	3RT2646-1AB03 3RT2646-1AF03 3RT2646-1AP03	1 1 1	1 unit 1 unit 1 unit	41B 41B 41B	
57	100	125	172	0	2	24 110 230	3RT2646-1AB05 3RT2646-1AF05 3RT2646-1AP05	1 1 1	1 unit 1 unit 1 unit	41B 41B 41B	

Other voltages according to page 4/52 on request.

Accessories, see page 3/71 onwards.

## Switching devices – Contactors and contactor assemblies – Special applications

### Contactors for special applications

#### SIRIUS 3RT26 contactors for capacitive loads (AC-6b), 3-pole

##### DC operation

Main, auxiliary and control conductors: Screw terminals





3RT2617-1B.45



3RT262.-1B.45



3RT2628-1B.45  
with infeed terminal

<b>Utilization category AC-6b</b> Switching AC capacitors at an ambient temperature of 60 °C  Capacitor rating at operational voltage 50/60 Hz at 230 V <b>at 400 V</b> at 500 V   at 690 V kvar <b>kvar</b> kvar   kvar	Auxiliary contacts, unassigned Version    V	Rated control supply voltage $U_s$  DC	<b>Screw terminals</b> 	PU (UNIT, SET, M)	PS*	PG

#### For screw fixing and snap-on mounting on TH 35 DIN rail

##### Size S00

7.2	<b>12.5</b>	15	21	1	1	24 110	<b>3RT2617-1BB43</b>	1	1 unit	41B
							<b>3RT2617-1BF43</b>	1	1 unit	41B
7.2	<b>12.5</b>	15	21	0	2	24 110	<b>3RT2617-1BB45</b>	1	1 unit	41B
							<b>3RT2617-1BF45</b>	1	1 unit	41B

##### Size S0

9.6	<b>16.7</b>	21	29	1	2	24 110	<b>3RT2625-1BB45</b>	1	1 unit	41B
							<b>3RT2625-1BF45</b>	1	1 unit	41B
11.5	<b>20</b>	25	34	1	2	24 110	<b>3RT2626-1BB45</b>	1	1 unit	41B
							<b>3RT2626-1BF45</b>	1	1 unit	41B
14	<b>25</b>	31	43	1	2	24 110	<b>3RT2627-1BB45</b>	1	1 unit	41B
							<b>3RT2627-1BF45</b>	1	1 unit	41B
19	<b>33</b>	41	57	1	2	24 110	<b>3RT2628-1BB45</b>	1	1 unit	41B
							<b>3RT2628-1BF45</b>	1	1 unit	41B

Other voltages according to page 4/52 on request.

Accessories, see page 3/71 onwards.

## Switching devices – Contactors and contactor assemblies – Special applications

### Contactors for special applications

#### SIRIUS 3RT26 contactors for capacitive loads (AC-6b), 3-pole

#### AC/DC operation

Main, auxiliary and control conductors: Screw terminals

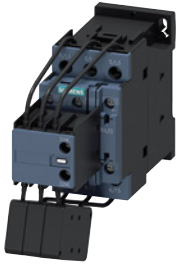

3RT262.-1N.35





3RT2628-1N.35  
with infeed terminal



3RT263.-1N.35



3RT264.-1N.35

<b>Utilization category AC-6b</b> Switching AC capacitors at an ambient temperature of 60 °C  Capacitor rating at operational voltage 50/60 Hz at 230 V <b>at 400 V</b> at 500 V    at 690 V kvar        kvar        kvar        kvar	Auxiliary contacts, unassigned Version   NO    NC    V	Rated control supply voltage $U_s$  50/60 Hz AC or DC	<b>Screw terminals</b> 	 PU (UNIT, SET, M)	PS*	PG

#### For screw fixing and snap-on mounting on TH 35 DIN rail

##### Size S0

9.6	16.7	21	29	1	2	21 ... 28 95 ... 130 200 ... 280	3RT2625-1NB35 3RT2625-1NF35 3RT2625-1NP35	1 1 1	1 unit 1 unit 1 unit	41B 41B 41B
11.5	20	25	34	1	2	21 ... 28 95 ... 130 200 ... 280	3RT2626-1NB35 3RT2626-1NF35 3RT2626-1NP35	1 1 1	1 unit 1 unit 1 unit	41B 41B 41B
14	25	31	43	1	2	21 ... 28 95 ... 130 200 ... 280	3RT2627-1NB35 3RT2627-1NF35 3RT2627-1NP35	1 1 1	1 unit 1 unit 1 unit	41B 41B 41B
19	33	41	57	1	2	21 ... 28 95 ... 130 200 ... 280	3RT2628-1NB35 3RT2628-1NF35 3RT2628-1NP35	1 1 1	1 unit 1 unit 1 unit	41B 41B 41B

##### Size S2

29	50	63	86	0	2	20 ... 33 83 ... 155 175 ... 280	3RT2636-1NB35 3RT2636-1NF35 3RT2636-1NP35	1 1 1	1 unit 1 unit 1 unit	41B 41B 41B
43	75	94	129	0	2	20 ... 33 83 ... 155 175 ... 280	3RT2637-1NB35 3RT2637-1NF35 3RT2637-1NP35	1 1 1	1 unit 1 unit 1 unit	41B 41B 41B

#### For screw fixing and snap-on mounting on TH 35-15 and TH 75-15 DIN rails

##### Size S3

43	75	94	129	0	2	20 ... 33 83 ... 155 175 ... 280	3RT2645-1NB35 3RT2645-1NF35 3RT2645-1NP35	1 1 1	1 unit 1 unit 1 unit	41B 41B 41B
57	100	125	172	0	2	20 ... 33 83 ... 155 175 ... 280	3RT2646-1NB35 3RT2646-1NF35 3RT2646-1NP35	1 1 1	1 unit 1 unit 1 unit	41B 41B 41B

Other voltages according to page 4/52 on request.

Accessories, see page 3/71 onwards.

# Switching devices – Contactors and contactor assemblies – Special applications

## Contactors for special applications

### SIRIUS 3RT23 to 3RT26, 3RT14 contactors

#### Options

#### Rated control supply voltages for 3RT2 contactors, possible on request (change of the 10th and 11th digits of the article number)

Delivery time on request

Rated control supply voltage $U_s$	Contactor type	3RT231, 3RT251	3RT232, 3RT252	3RT233, 3RT253	3RT234, 3RT244, 3RT254	3RT2617, 3RT262, 3RT263, 3RT264
	Size	S00	S0	S2	S3	S00 to S3

#### Sizes S00 to S3

#### AC operation<sup>1)</sup>

##### Solenoid coils for 50 Hz

(exception: Size S00: 50 and 60 Hz<sup>2)</sup>)

24 V AC	B0	B0	B0	B0	B0
42 V AC	D0	D0	D0	D0	--
48 V AC	H0	--	--	H0	--
110 V AC	F0	F0	F0	F0	F0
230 V AC	P0	P0	P0	P0	P0
240 V AC	--	--	U0	U0	--
400 V AC	V0	V0	V0	V0	--

##### Solenoid coils for 50 and 60 Hz<sup>2)</sup>

24 V AC	B0	C2	C2	C2	C2
42 V AC	D0	D2	D2	D2	--
48 V AC	H0	H2	H2	H2	--
110 V AC	F0	G2	G2	G2	--
220 V AC	N2	N2	N2	N2	N2
230 V AC	P0	L2	L2	L2	L2

##### Solenoid coils (for USA and Canada<sup>3)</sup>)

50 Hz	60 Hz				
110 V AC	120 V AC	K6	K6	K6	--
220 V AC	240 V AC	P6	P6	P6	--

##### Solenoid coils (for Japan)

50/60 Hz <sup>4)</sup>	60 Hz <sup>5)</sup>				
100 V AC	110 V AC	G6	G6	G6	G6
200 V AC	220 V AC	N6	N6	N6	N6
400 V AC	440 V AC	R6	R6	R6	R6

#### DC operation<sup>1)</sup>

12 V DC	A4	A4	--	--	--
24 V DC	B4	B4	--	--	B4
42 V DC	D4	D4	--	--	--
48 V DC	W4	W4	--	--	--
60 V DC	--	--	--	--	--
110 V DC	F4	F4	--	--	F4
125 V DC	G4	G4	--	--	--
220 V DC	M4	M4	--	--	--
230 V DC	P4	--	--	--	--

#### Examples

<b>AC operation</b>	3RT2325-1AP00 3RT2325-1AG20	Contactors with screw terminals; with solenoid coil for 50 Hz for rated control supply voltage 230 V AC Contactors with screw terminals; with solenoid coil for 50/60 Hz for rated control supply voltage 110 V AC
<b>DC operation</b>	3RT2526-2BB40 3RT2526-2BG40	Contactors with spring-loaded terminals; for rated control supply voltage of 24 V DC Contactors with spring-loaded terminals; for rated control supply voltage 125 V DC

<sup>1)</sup> For deviating coil voltages and operating ranges of sizes S00 and S0, a SITOP 24 V DC power supply with wide-range input can be used for the coil control, see page 15/1 or Catalog KT 10.1.

<sup>2)</sup> Coil operating range  
- at 50 Hz:  $0.8$  to  $1.1 \times U_s$ ,  
- at 60 Hz:  $0.85$  to  $1.1 \times U_s$ .

<sup>3)</sup> Coil operating range  
- Size S00:  
at 50 Hz:  $0.85$  to  $1.1 \times U_s$ ,  
at 60 Hz:  $0.8$  to  $1.1 \times U_s$ ,  
- Sizes S0 to S3: at 50 Hz and 60 Hz:  $0.8$  to  $1.1 \times U_s$ .

<sup>4)</sup> Coil operating range  
- Size S00:  
at 50/60 Hz:  $0.85$  to  $1.1 \times U_s$ ,  
- Sizes S0 to S3:  
at 50 Hz:  $0.8$  to  $1.1 \times U_s$ ,  
at 60 Hz:  $0.85$  to  $1.1 \times U_s$ .

<sup>5)</sup> Coil operating range at 60 Hz:  $0.8$  to  $1.1 \times U_s$ .

Rated control supply voltage	Contactor type	3RT2.2.-N	Rated control supply voltage	Contactor type	3RT2.3.-N	3RT2.4.-N
$U_{s \min}$ to $U_{s \max}$ <sup>1)</sup>	Size	S0	$U_{s \min}$ to $U_{s \max}$ <sup>1)</sup>	Size	S2	S3

#### Sizes S0 to S3

#### AC/DC operation (50/60 Hz AC or DC)

21 ... 28 V AC/DC	B3	20 ... 33 V AC/DC	B3	B3
95 ... 130 V AC/DC	F3	48 ... 80 V AC/DC	E3	E3
200 ... 280 V AC/DC	P3	83 ... 155 V AC/DC	F3	F3
		175 ... 280 V AC/DC	P3	P3

<sup>1)</sup> Coil operating range:  $0.8 \times U_{s \min}$  to  $1.1 \times U_{s \max}$ .

## Switching devices – Contactors and contactor assemblies – Special applications

### Contactors for special applications

#### SIRIUS 3RT23 to 3RT26, 3RT14 contactors

**Rated control supply voltages for 3RT14 contactors,  
possible on request (change of the 10th and 11th digits of the article number)**

Delivery time on request

Rated control supply voltage	<b>Contactor type</b> 3RT145.-A, 3RT146.-A, 3RT147.-A	Rated control supply voltage	<b>Contactor type</b> 3RT145.-N, 3RT146.-N, 3RT147.-N	3RT145.-P, 3RT145.-S, 3RT146.-P, 3RT146.-S, 3RT147.-P, 3RT147.-S
$U_{s \min}$ to $U_{s \max}$	<b>Sizes</b> S6 to S12	$U_{s \min}$ to $U_{s \max}$	<b>Sizes</b> S6 to S12	

**Sizes S6 to S12**

**AC/DC operation (50/60 Hz AC or DC) and operating range  $0.8 \times U_{s \min}$  to  $1.1 \times U_{s \max}$**

**Standard operating mechanism**

23 ... 26 V AC/DC	B3
42 ... 48 V AC/DC	D3
110 ... 127 V AC/DC	F3
200 ... 220 V AC/DC	M3
220 ... 240 V AC/DC	P3
240 ... 277 V AC/DC	U3
380 ... 420 V AC/DC	V3
440 ... 480 V AC/DC	R3
500 ... 550 V AC/DC	S3
575 ... 600 V AC/DC	T3

**Solid-state operating mechanism**

21 ... 27.3 V AC/DC	B3	--
96 ... 127 V AC/DC	F3	F3
200 ... 277 V AC/DC	P3	P3



## Switching devices – Contactors and contactor assemblies – Special applications

Contactors for special applications

Contactors for railway applications

### SIRIUS 3RT contactors with extended operating range, 3-pole

#### Overview

##### Standards

IEC 60947-4-1, IEC 60077-2, EN 50155

##### Performance range

###### Sizes S00 to S3

- 3RT20 contactors for motor loads (AC-3 and AC-3e) up to 110 A/55 kW

###### Sizes S6 to S12

- 3RT10 contactors for motor loads (AC-3 and AC-3e) from 55 kW to 500 A/250 kW
- 3RT14 contactors for weak or non-inductive loads (AC-1) up to 690 A

#### Application

Besides standard approval in compliance with IEC 60947-4-1, the contactors with an extended operating range are also approved in compliance with the relevant parts of IEC 60077-2, thus fulfilling the requirement for use in railway applications.

Thus, their suitability for increased requirements such as an

- extended temperature range compared to the IEC 60947-4-1 product standard or
- extended operating range of the contactor operating mechanisms or also
- increased resistance to mechanical oscillations and vibrations is warranted. The design of the terminals in the spring-loaded connection system also contributes toward vibration resistance.

##### Operating range of contactor operating mechanisms

The contactors with extended operating range and railway approval are available with a solid-state DC operating mechanism in all sizes from S00 to S12.

This operating mechanism version has an operating range from 0.7 to 1.25 x  $U_N$  in the temperature range -40 to 70 °C.

As from size S6, the operating mechanisms are equipped with an additional control input that can be operated between 24 DC and 110 V. This function can optionally be switched on or off via a selector switch.

##### Protecting connections against short circuit, overload and overvoltage

All connections must generally be protected against overload and short circuits using suitable measures. Different constraints must be considered depending on the type of connection:

###### Short-circuit and overload protection of main connections

For information on the protection of a free-standing contactor, see the [technical product data sheet](#).

For more information on device combinations such as contactor with overload relay or contactor with circuit breaker as motor feeder, refer to

- [Digital Configuration Manual for load feeders](#)
- [Configuration Manual for load feeders](#)

###### Short-circuit and overload protection of auxiliary connections

For information on the protection of auxiliary contacts, see the [technical product data sheet](#).

###### Short-circuit and overload protection of control supply voltage or supply voltage connections

First of all, the relevant standards and regulations for configuring control panels and the parts and components installed in them must be taken into account, for example for cable dimensioning.

One possible protection for these circuits could be the selection of a suitable power supply, i.e. one with a current-limiting function. In the selection of the source and the connecting cable, the load characteristics of the contactor must be considered (short-time inrush current peaks for solid-state contactor operating mechanisms, switch-on power, holding power). The same applies to the selection of suitable protection devices.

If there are further switching elements in the circuit, such as the auxiliary contact system of an overload relay that operates the contactor, the short-circuit protection necessary for this must also be considered.

For further recommendations, e.g. the use of miniature circuit breakers or circuit breakers for equipment in control circuits, see [Control panel tip – Selecting and dimensioning suitable power supplies quickly and reliably](#).

###### Short-circuit and overload protection of contactors with digital input

A typical rated current of 20 mA applies to these inputs based on the PLC input types according to IEC 60947-4-1.

The inputs can be protected accordingly (for 3RT1...-X contactors, marked with IN+/IN-). The supply voltage connections A1 - A2 must be protected based on the load characteristics.

For information on power consumption, see the [technical product data sheet](#).

###### Protection against overvoltage at the control supply voltage connection

3RT contactors are already equipped with coil damping (varistor).

###### Note:

The break times of the contactor, the opening delay times of the NO contacts and the closing delay times of the NC contacts increase in the event of damping.

For more information about influencing the time response using damping, see [Equipment Manual](#).

## Switching devices – Contactors and contactor assemblies – Special applications

Contactors for special applications

Contactors for railway applications

### SIRIUS 3RT contactors with extended operating range, 3-pole

#### **Fitting auxiliary contacts and mounting additional auxiliary switches**

##### Features in the delivery state

- 3RT20 contactors:
  - 3RT201 contactors:  
An auxiliary contact is integrated in the basic unit.
  - 3RT202 to 3RT204 contactors:  
The basic units contain two integrated auxiliary contacts (1 NO + 1 NC).
- 3RT10 and 3RT14 contactors:  
These contactors are supplied with two laterally mounted auxiliary switches. The fitting of auxiliary switches is possible on the front and on the side.

##### Expansion possibilities

All basic units (with the exception of coupling contactors in size S00) can be expanded using auxiliary switches; the permissible configuration must be observed.

Detailed information about the fitting of auxiliary switches for 3RT20 contactors, [see pages 3/83 to 3/90](#).

#### **Ambient temperature**

The permissible ambient temperature for operation of the contactors (across the full operating range of the operating mechanisms) is -40 to +70 °C.

#### **Side-by-side mounting**

##### Contactors with conventional operating mechanism

- Sizes S00 and S0:  
Side-by-side mounting is permissible at ambient temperatures up to 60 °C. At > 60 to 70 °C, a clearance of at least 10 mm shall be provided.

##### Contactors with series resistor

- Size S00:  
Side-by-side mounting is permissible at ambient temperatures up to 70 °C.

##### Contactors with solid-state operating mechanism (version: 3RT.....-.....-0LA2)

- Sizes S00 to S3:  
Side-by-side mounting is permissible at ambient temperatures up to 70 °C.
- Sizes S6 to S12:  
Side-by-side mounting is permissible at ambient temperatures up to 60 °C. At > 60 to 70 °C, a clearance of at least 10 mm shall be provided.

## Switching devices – Contactors and contactor assemblies – Special applications

Contactors for special applications

Contactors for railway applications

### SIRIUS 3RT contactors with extended operating range, 3-pole

#### Technical specifications

More information												
Technical specifications, see <a href="https://support.industry.siemens.com/cs/ww/en/ps/16177/td">https://support.industry.siemens.com/cs/ww/en/ps/16177/td</a>		Manuals, see <a href="https://support.industry.siemens.com/cs/ww/en/ps/16177/man">https://support.industry.siemens.com/cs/ww/en/ps/16177/man</a>										
FAQs, see <a href="https://support.industry.siemens.com/cs/ww/en/ps/16177/faq">https://support.industry.siemens.com/cs/ww/en/ps/16177/faq</a>		Guide of use for contactors in safety applications, see <a href="https://support.industry.siemens.com/cs/ww/en/view/109807687">https://support.industry.siemens.com/cs/ww/en/view/109807687</a>										
Type		3RT2017	3RT2017- 2XB4- 0LA2	2XF4- 0LA2	3RT2018- 2XB4- 0LA2	2XF4- 0LA2	3RT202.	3RT202.- 2XB40- 0LA2	2XF40- 0LA2			
Size		S00					S0					
<b>General data</b>												
<b>Upright mounting position</b>												
<ul style="list-style-type: none"> <li>Contactors with series resistor</li> <li>Contactors with conventional coil</li> </ul>		Special version (on request) Special version (on request)										
<b>Ambient temperature</b>												
• During operation		°C	-40 ... +70 <sup>1)</sup>		-40 ... +70							
• During storage		°C	-55 ... +80									
<b>Control</b>												
<b>Solenoid coil operating range</b>		DC	0.7 ... 1.25 x U <sub>s</sub>									
<b>Power consumption of the solenoid coils</b>		For cold coil and 1.0 x U <sub>s</sub>										
• Contactors with series resistor		Closing	W	13	--							
		Closed	W	4.0	--							
• Contactors with conventional coil		Closing	W	2.8	--		4.5	--				
		Closed	W	2.8	--		4.5	--				
• Contactors with solid-state operating mechanism		Closing	W	--	4.0	4.5	4.0	4.5	--	6.7	13.2	
		Closed	W	--	0.95	0.75	0.95	0.75	--	1.4	1.3	
<b>Rated data of the main contacts</b>												
<b>Load rating with AC</b>												
<b>Minimum cross-section in the main circuit</b>												
• At maximum AC-1 rated value		mm <sup>2</sup>	4						10			
• At maximum I <sub>th</sub> rated value		mm <sup>2</sup>	--	4						--	10	
<sup>1)</sup> 3RT20...K contactors without the article number suffix "-0LA2" are coupling contactors that are certified for the -25 to +60 °C standard temperature range. For railway applications, an additional certification approves these contactors with a minimum clearance of 10 mm for the extended temperature range from -40 to +70 °C.		All details and technical specifications not mentioned here are identical to those of the basic units, see page 3/25 onwards.										
Type		3RT2035- 3XB40- 0LA2	3XF40- 0LA2	3RT2036- 3XB40- 0LA2	3XF40- 0LA2	3RT2037- 3XB40- 0LA2	3XF40- 0LA2	3RT2038- 3XB40- 0LA2	3XF40- 0LA2	3RT204.- 3XB40- 0LA2	3XF40- 0LA2	
Size		S2						S3				
<b>General data</b>												
<b>Ambient temperature</b>												
• During operation		°C	-40 ... +70									
• During storage		°C	-55 ... +80									
<b>Control</b>												
<b>Solenoid coil operating range</b>		DC	0.7 ... 1.25 x U <sub>s</sub>									
<b>Power consumption of the solenoid coils</b>		For cold coil and 1.0 x U <sub>s</sub>										
• Contactors with solid-state operating mechanism		Closing	W	23						76	64	
		Closed	W	1						1.8	1.0	
<b>Rated data of the main contacts</b>												
<b>Load rating with AC</b>												
<b>Minimum cross-section in the main circuit</b>												
• At maximum AC-1 rated value		mm <sup>2</sup>	16	25				35	50			
• At maximum I <sub>th</sub> rated value		mm <sup>2</sup>	16	25				35	50			

All details and technical specifications not mentioned here are identical to those of the basic units, see page 3/25 onwards.

## Switching devices – Contactors and contactor assemblies – Special applications

Contactors for special applications

Contactors for railway applications

## SIRIUS 3RT contactors with extended operating range, 3-pole

Type		3RT1054- .X.46- 0LA2	3RT1055- .X.46- 0LA2	3RT1056- .X.46- 0LA2	3RT1064- .X.46- 0LA2	3RT1065- .X.46- 0LA2	3RT1066- .X.46- 0LA2	3RT1075- .X.46- 0LA2	3RT1076- .X.46- 0LA2
Size		S6			S10		S12		
<b>General data</b>									
<b>Ambient temperature</b>									
• During operation	°C	-40 ... +70							
• During storage	°C	-55 ... +80							
<b>Control</b>									
• Solenoid coil closing for DC	W	320			580		800		
• Solenoid coil closed for DC	W	2.8			3.4		3.6		
• Control version of the switch operating mechanism		PLC-IN or standard A1 - A2 (can be set)							
<u>Actuated via A1/A2</u>									
• Rated control supply voltage	V DC	24, 72 or 110							
• Operating range		0.7 ... 1.25							
<u>Actuated via PLC input</u>									
• Rated voltage	V DC	24 ... 110							
• Operating range		0.7 ... 1.25							
• Consumed current at PLC control input according to IEC 60947-1, maximum	mA	2							
<b>Rated data of the main contacts</b>									
<b>Load rating with AC</b>									
<b>Minimum cross-section in the main circuit</b>									
• At maximum AC-1 rated value	mm <sup>2</sup>	70	95	150	185	300	370		
• At maximum $I_{th}$ rated value	mm <sup>2</sup>	70	95	150	185	300	370		

For all details and technical specifications not mentioned here, see <https://support.industry.siemens.com/cs/ww/en/ps/16177/td>.

Type		3RT1456-.X.46-0LA2	3RT1466-.X.46-0LA2	3RT1467-.X.46-0LA2	3RT1476-.X.46-0LA2
Size		S6		S10	S12
<b>General data</b>					
<b>Ambient temperature</b>					
• During operation	°C	-40 ... +70			
• During storage	°C	-55 ... +80			
<b>Control</b>					
• Solenoid coil closing for DC		320	580		800
• Solenoid coil closed for DC		2.8	3.4		3.6
• Control version of the switch operating mechanism		PLC-IN or standard A1 - A2 (can be set)			
<u>Actuated via A1/A2</u>					
• Rated control supply voltage	V DC	24, 72 or 110			
• Operating range		0.7 ... 1.25			
<u>Actuated via PLC input</u>					
• Rated voltage	V DC	24 ... 110			
• Operating range		0.7 ... 1.25			
• Consumed current at PLC control input according to IEC 60947-1, maximum	mA	2			
<b>Rated data of the main contacts</b>					
<b>Load rating with AC</b>					
<b>Minimum cross-section in the main circuit</b>					
• At maximum AC-1 rated value	mm <sup>2</sup>	140	240	300	480
• At maximum $I_{th}$ rated value	mm <sup>2</sup>	140	240	300	480

For all details and technical specifications not mentioned here, see <https://support.industry.siemens.com/cs/ww/en/ps/16177/td>.

# Switching devices – Contactors and contactor assemblies – Special applications

## Contactors for special applications

## Contactors for railway applications

**SIRIUS 3RT contactors with extended operating range, 3-pole**
**IE3/IE4 ready**
**AC-3e**

### Selection and ordering data

**DC operation**

3RT201-2K.4.



3RT201-2K.42-0LA0

Rated data according to IEC 60947-4-1		Auxiliary contacts		Rated control supply voltage $U_s$	Spring-loaded terminals	PU (UNIT, SET, M)	PS*	PG
AC-3 and AC-3e, $t_{ij}$ : 70 °C	Operational current $I_e$ up to	Rating of three-phase motors at	Ident. No.					
	400 V	230 V	<b>400 V</b>	500 V	690 V			
A	kW	kW	kW	kW				
					NO	NC	V DC	

**For screw fixing and snap-on mounting on TH 35 DIN rail**
**Size S00**

#### Coupling contactors with integrated coil circuit

- Suppressor diode integrated at the factory

12	3	<b>5.5</b>	5.5	5.5	<b>10<sup>1)</sup></b>	1	--	24 110	<b>3RT2017-2KB41</b>	1	1 unit	41B
									<b>3RT2017-2KF41</b>	1	1 unit	41B
12	3	<b>5.5</b>	5.5	5.5	<b>01<sup>1)</sup></b>	--	1	24 110	<b>3RT2017-2KB42</b>	1	1 unit	41B
									<b>3RT2017-2KF42</b>	1	1 unit	41B

- Varistor integrated at the factory

12	3	<b>5.5</b>	5.5	5.5	<b>10<sup>1)</sup></b>	1	--	24 110	<b>3RT2017-2LB41</b>	1	1 unit	41B
									<b>3RT2017-2LF41</b>	1	1 unit	41B
12	3	<b>5.5</b>	5.5	5.5	<b>01<sup>1)</sup></b>	--	1	24 110	<b>3RT2017-2LB42</b>	1	1 unit	41B
									<b>3RT2017-2LF42</b>	1	1 unit	41B

#### With plug-on series resistor and integrated coil circuit

- Suppressor diode integrated at the factory

12	3	<b>5.5</b>	5.5	5.5	<b>--<sup>2)</sup></b>	--	1 <sup>3)</sup>	24 110	<b>3RT2017-2KB42-0LA0</b>	1	1 unit	41B
									<b>3RT2017-2KF42-0LA0</b>	1	1 unit	41B
16	4	<b>7.5</b>	10	11	<b>--<sup>2)</sup></b>	--	1 <sup>3)</sup>	24 110	<b>3RT2018-2KB42-0LA0</b>	1	1 unit	41B
									<b>3RT2018-2KF42-0LA0</b>	1	1 unit	41B

- Varistor integrated at the factory

12	3	<b>5.5</b>	5.5	5.5	<b>--<sup>2)</sup></b>	--	1 <sup>3)</sup>	24 110	<b>3RT2017-2LB42-0LA0</b>	1	1 unit	41B
									<b>3RT2017-2LF42-0LA0</b>	1	1 unit	41B
16	4	<b>7.5</b>	10	11	<b>--<sup>2)</sup></b>	--	1 <sup>3)</sup>	24 110	<b>3RT2018-2LB42-0LA0</b>	1	1 unit	41B
									<b>3RT2018-2LF42-0LA0</b>	1	1 unit	41B

<sup>1)</sup> It is not possible to mount an auxiliary switch. A clearance of 10 mm is required for side-by-side mounting at ambient temperatures > 60 °C.

<sup>2)</sup> One 4-pole auxiliary switch according to EN 50005 can be mounted from -40 to 70 °C; no clearance required.

<sup>3)</sup> NC contact cannot be used because it is used for switching of the series resistor.

Accessories and spare parts, [see page 3/71 onwards](#).

# Switching devices – Contactors and contactor assemblies – Special applications

Contactors for special applications

Contactors for railway applications

**AC-3e** **IE3/IE4 ready** **SIRIUS 3RT contactors with extended operating range, 3-pole**

## DC operation



3RT201.-2X.41-0LA2





3RT201.-2X.42-0LA2



3RT202.-2K.40



3RT202.-2X.40-0LA2

Rated data according to		Auxiliary contacts		Rated control supply voltage $U_s$	Spring-loaded terminals 	PU (UNIT, SET, M)	PS*	PG
IEC 60077-2	IEC 60947-4-1 AC-3 and AC-3e	Ident. No.	Version					
$t_u$ : 70 °C Conventional thermal current $I_{th}$ up to	$t_u$ : 60 °C Operational current $I_e$ up to	Rating of three-phase motors at		  NO NC V DC	Article No.	Price per PU		
690 V A	400 V A	230 V kW	<b>400 V</b> kW				500 V kW	690 V kW

**For screw fixing and snap-on mounting on TH 35 DIN rail**

### Size S00

With integrated coil circuit (varistor integrated in electronics at the factory)

18	12	3	5.5	5.5	5.5	10	1	--	24 ... 34 72 ... 125	3RT2017-2XB41-0LA2 3RT2017-2XF41-0LA2	1	1 unit	41B
18	12	3	5.5	5.5	5.5	01	--	1	24 ... 34 72 ... 125	3RT2017-2XB42-0LA2 3RT2017-2XF42-0LA2	1	1 unit	41B
18	16	4	7.5	10	11	10	1	--	24 ... 34 72 ... 125	3RT2018-2XB41-0LA2 3RT2018-2XF41-0LA2	1	1 unit	41B
18	16	4	7.5	10	11	01	--	1	24 ... 34 72 ... 125	3RT2018-2XB42-0LA2 3RT2018-2XF42-0LA2	1	1 unit	41B

### Size S0

With integrated coil circuit

• Coupling contactors with varistor integrated at the factory

--	17	4	7.5	10	11	11 <sup>1)</sup>	1	1	24 110	3RT2025-2KB40 3RT2025-2KF40	1	1 unit	41B
--	25	5.5	11	11	11	11 <sup>1)</sup>	1	1	24 110	3RT2026-2KB40 3RT2026-2KF40	1	1 unit	41B
--	32	7.5	15	18.5	18.5	11 <sup>1)</sup>	1	1	24 110	3RT2027-2KB40 3RT2027-2KF40	1	1 unit	41B

• Varistor integrated in electronics at the factory

30	17	4	7.5	10	11	11	1	1	24 110	3RT2025-2XB40-0LA2 3RT2025-2XF40-0LA2	1	1 unit	41B
30	25	5.5	11	11	11	11	1	1	24 110	3RT2026-2XB40-0LA2 3RT2026-2XF40-0LA2	1	1 unit	41B
36	32	7.5	15	18.5	18.5	11	1	1	24 110	3RT2027-2XB40-0LA2 3RT2027-2XF40-0LA2	1	1 unit	41B
38	38	7.5	18.5	18.5	18.5	11	1	1	24 110	3RT2028-2XB40-0LA2 3RT2028-2XF40-0LA2	1	1 unit	41B

<sup>1)</sup> It is not possible to mount an auxiliary switch. A clearance of 10 mm is required for side-by-side mounting at ambient temperatures > 60 °C.

Accessories and spare parts, see page 3/71 onwards.







# Switching devices – Contactors and contactor assemblies – Special applications

Contactors for special applications

Contactors for railway applications

**AC-3e** **IE3/IE4 ready** **SIRIUS 3RT contactors with extended operating range, 3-pole**

## DC operation

- Solid-state operating mechanism with 24 to 110 V DC control signal input
- For screw fixing
- Auxiliary and control conductors: Spring-loaded terminals
- Main conductors: Busbar connections; a connection kit with screws, spring washers and nuts is enclosed.





3RT105.-2X.46-0LA2



3RT106.-2X.46-0LA2



3RT107.-2X.46-0LA2

Size	Rated data according to IEC 60077-2	Rated data according to IEC 60947-4-1 AC-3 and AC-3e	Auxiliary contacts, lateral	Rated control supply voltage $U_s$	Spring-loaded terminals 	PU (UNIT, SET, M)	PS*	PG
	$t_{ij}$ : 70 °C Conventional thermal current $I_{th}$ up to 690 V	$t_{ij}$ : 60 °C Operational current $I_e$ up to 400 V	Version  	V DC	Article No.	Price per PU		
A		A	NO NC					

## Solid-state operating mechanism

With control signal input 24 ... 110 V DC  
e.g. for control by PLC

With integrated coil circuit (varistor integrated in electronics at the factory)

S6	120	115	2	2	24 72 110	3RT1054-2XB46-0LA2 3RT1054-2XJ46-0LA2 3RT1054-2XF46-0LA2	1 1 1	1 unit 1 unit 1 unit	41B 41B 41B
	140	150	2	2	24 72 110	3RT1055-2XB46-0LA2 3RT1055-2XJ46-0LA2 3RT1055-2XF46-0LA2	1 1 1	1 unit 1 unit 1 unit	41B 41B 41B
	145	185	2	2	24 72 110	3RT1056-2XB46-0LA2 3RT1056-2XJ46-0LA2 3RT1056-2XF46-0LA2	1 1 1	1 unit 1 unit 1 unit	41B 41B 41B
S10	215	225	2	2	24 72 110	3RT1064-2XB46-0LA2 3RT1064-2XJ46-0LA2 3RT1064-2XF46-0LA2	1 1 1	1 unit 1 unit 1 unit	41B 41B 41B
	265	265	2	2	24 72 110	3RT1065-2XB46-0LA2 3RT1065-2XJ46-0LA2 3RT1065-2XF46-0LA2	1 1 1	1 unit 1 unit 1 unit	41B 41B 41B
	265	300	2	2	24 72 110	3RT1066-2XB46-0LA2 3RT1066-2XJ46-0LA2 3RT1066-2XF46-0LA2	1 1 1	1 unit 1 unit 1 unit	41B 41B 41B
S12	350	400	2	2	24 72 110	3RT1075-2XB46-0LA2 3RT1075-2XJ46-0LA2 3RT1075-2XF46-0LA2	1 1 1	1 unit 1 unit 1 unit	41B 41B 41B
	475	500	2	2	24 72 110	3RT1076-2XB46-0LA2 3RT1076-2XJ46-0LA2 3RT1076-2XF46-0LA2	1 1 1	1 unit 1 unit 1 unit	41B 41B 41B

Accessories and spare parts, see page 3/71 onwards.

## Switching devices – Contactors and contactor assemblies – Special applications

Contactors for special applications

Contactors for railway applications

### SIRIUS 3RT contactors with extended operating range, 3-pole

#### DC operation

- Solid-state operating mechanism with 24 to 110 V DC control signal input
- For screw fixing
- Auxiliary and control conductors: Spring-loaded terminals
- Main conductors: Busbar connections; a connection kit with screws, spring washers and nuts is enclosed.





3RT1456-2X.46-0LA2



3RT146-2X.46-0LA2



3RT1476-2X.46-0LA2

Size	Rated data according to IEC 60077-2	Rated data according to IEC 60947-4-1 AC-1	Auxiliary contacts, lateral	Rated control supply voltage $U_s$	Version	Spring-loaded terminals 	PU (UNIT, SET, M)	PS*	PG
A	$t_{ij}$ : 70 °C Conventional thermal current $I_{th}$ up to 690 V	$t_{ij}$ : 40 °C Operational current $I_e$ up to 400 V	NO NC	V DC	 	Article No.	Price per PU		

#### Solid-state operating mechanism

With control signal input 24 ... 110 V DC

e.g. for control by PLC

With integrated coil circuit (varistor integrated in electronics at the factory)

Size	Rated current $I_{th}$ [A]	Rated current $I_e$ [A]	NO	NC	Rated control supply voltage $U_s$ [V DC]	Article No.	PU	PS*	PG
S6	190	275	2	2	24 72 110	3RT1456-2XB46-0LA2	1	1 unit	41B
						3RT1456-2XJ46-0LA2	1	1 unit	41B
						3RT1456-2XF46-0LA2	1	1 unit	41B
S10	330	400	2	2	24 72 110	3RT1466-2XB46-0LA2	1	1 unit	41B
						3RT1466-2XJ46-0LA2	1	1 unit	41B
						3RT1466-2XF46-0LA2	1	1 unit	41B
	330	500	2	2	24 72 110	3RT1467-2XB46-0LA2	1	1 unit	41B
						3RT1467-2XJ46-0LA2	1	1 unit	41B
						3RT1467-2XF46-0LA2	1	1 unit	41B
S12	520	690	2	2	24 72 110	3RT1476-2XB46-0LA2	1	1 unit	41B
						3RT1476-2XJ46-0LA2	1	1 unit	41B
						3RT1476-2XF46-0LA2	1	1 unit	41B

Accessories and spare parts, see page 3/71 onwards.

## Overview

### Standards

IEC 60947-5-1

### Ambient temperature

The permissible ambient temperature for operation of the contactor relays (across the full operating range of the operating mechanisms) is -40 to +70 °C.

Uninterrupted duty at temperatures > +60 °C reduces the mechanical endurance, the current carrying capacity of the conducting paths and the switching frequency.

## Application

For operation in installations that are subject both to considerable variations in the control voltage and to high ambient temperatures, e.g. railway applications under extreme climatic conditions, rolling mills, etc.

Also for control supply voltages with battery buffering to extend the operating time in the event of battery charge failure.

### Operating mechanism types

#### Contactor relays with conventional coil

These contactor relays have an extended operating range of 0.7 to 1.25 x  $U_s$ . An additional auxiliary switch is not required.

#### Contactor relays with series resistor

These contactor relays have an extended operating range of 0.7 to 1.25 x  $U_s$ .

The DC solenoid system is modified to holding operation by means of a series resistor. This is plugged on in a prewired module.

A 4-pole auxiliary switch can be fitted additionally.

#### Contactor relays with solid-state operating mechanism

Thanks to the integrated electronics, these contactor relays have an extended operating range of 0.7 to 1.25 x  $U_s$ .

### Protecting connections against short circuit, overload and overvoltage

All connections must generally be protected against overload and short circuits using suitable measures. Different constraints must be considered depending on the type of connection:

#### Short-circuit and overload protection of auxiliary connections

For information on the protection of auxiliary contacts, [see the technical product data sheet](#).

#### Short-circuit and overload protection of control supply voltage or supply voltage connections

First of all, the relevant standards and regulations for configuring control panels and the parts and components installed in them must be taken into account, for example for cable dimensioning.

One possible protection for these circuits could be the selection of a suitable power supply, i.e. one with a current-limiting function. In the selection of the source and the connecting cable, the load characteristics of the contactor relay must be considered (short-time inrush current peaks for solid-state contactor operating mechanisms, switch-on power, holding power). The same applies to the selection of suitable protection devices.

### Control and auxiliary circuits

The solenoid coils of the contactor relays have an extended coil operating range from 0.7 to 1.25 x  $U_s$  and are fitted as standard with surge suppressors. The opening delay times are consequently 2 to 5 ms longer than for standard contactors.

If there are further switching elements in the circuit, such as the auxiliary contact system of an overload relay that operates the auxiliary contactor, the short-circuit protection necessary for this must also be considered.

For further recommendations, e.g. the use of miniature circuit breakers or circuit breakers for equipment in control circuits, [see Control panel tip – Selecting and dimensioning suitable power supplies quickly and reliably](#).

#### Protection against overvoltage at the control supply voltage connection

- Contactor relays with conventional coil:  
A surge suppressor (suppressor diode) is integrated.
- Contactor relays with series resistor:  
A surge suppressor (suppressor diode or varistor as preferred) is integrated.
- Contactor relays with solid-state operating mechanism:  
A surge suppressor (varistor) is integrated.

### Connection methods

The 3RH2 contactor relays are available with screw terminals.

### Side-by-side mounting

#### Contactor relays with conventional coil

A clearance of 10 mm is required for side-by-side mounting at ambient temperatures > 60 °C ≤ 70 °C.

#### Contactor relays with series resistor

Side-by-side mounting is permissible at ambient temperatures up to 70 °C.

#### Contactor relays with solid-state operating mechanism

Side-by-side mounting is permissible at ambient temperatures up to 70 °C.

## Switching devices – Contactors and contactor assemblies – Special applications

Contactors for special applications

Contactors for railway applications

### SIRIUS 3RH2 contactor relays with extended operating range

#### Technical specifications

##### More information

Technical specifications, see  
<https://support.industry.siemens.com/cs/ww/en/ps/16174/td>  
 FAQs, see <https://support.industry.siemens.com/cs/ww/en/ps/16174/faq>

Manuals, see  
<https://support.industry.siemens.com/cs/ww/en/ps/16174/man>

Contactor relays	Type	3RH21..-2K, -2L	3RH2122-2XB40-0LA2	3RH2122-2XF40-0LA2	
<b>General data</b>					
<b>Upright mounting position</b>					
• Contactors with series resistor		Special version (on request)			
• Contactors with conventional coil		Special version (on request)			
<b>Ambient temperature</b>					
• During operation	°C	-40 ... +70 <sup>1)</sup>			
• During storage	°C	-55 ... +80			
<b>Control</b>					
<b>Solenoid coil operating range</b>	DC operation	0.7 ... 1.25 x $U_s$			
<b>Power consumption of the solenoid coils</b>					
For cold coil and 1.0 x $U_s$					
• Contactors with series resistor	Closing	W	13	--	--
	Closed	W	4	--	--
• Contactors with conventional coil	Closing	W	2.8	--	--
	Closed	W	2.8	--	--
• Contactors with solid-state operating mechanism	Closing	W	--	4	4.5
	Closed	W	--	0.95	0.75

<sup>1)</sup> 3RH21...K contactor relays without article number suffix "-0LA." are coupling contactor relays that are certified for the temperature range -25 to +60 °C. For railway applications, an additional certification approves these contactors with a minimum clearance of 10 mm for the extended temperature range from -40 to +70 °C.

All details and technical specifications not mentioned here are identical to those of the 3RH2 basic units, see page 5/5 onwards.

## Switching devices – Contactors and contactor assemblies – Special applications

Contactors for special applications

Contactors for railway applications

## SIRIUS 3RH2 contactor relays with extended operating range



## Selection and ordering data

DC operation 

3RH2122-2K.40



3RH2122-2K.40-0LA0

Rated operational current				Contacts Ident. No. according to EN 50011	Version	Rated control supply voltage $U_s$	Spring-loaded terminals		PU (UNIT, SET, M)	PS*	PG
$I_n$ /AC-15/AC-14 $t_{ij}$ : 70 °C at	230 V	400 V	500 V								
A	A	A	A		 	V DC	Article No.	Price per PU			

For screw fixing and snap-on mounting on TH 35 DIN rail

## Size S00

## With integrated coil circuit

- Suppressor diode integrated at the factory

10	3	2	1	22E	2	2 <sup>1)</sup>	24 110	3RH2122-2KB40 3RH2122-2KF40	1 1	1 unit 1 unit	41A 41A
				31E	3	1 <sup>1)</sup>	24	3RH2131-2KB40	1	1 unit	41A
				40E	4	0 <sup>1)</sup>	24	3RH2140-2KB40	1	1 unit	41A

- Varistor integrated at the factory

10	3	2	1	22E	2	2 <sup>1)</sup>	24 110	3RH2122-2LB40 3RH2122-2LF40	1 1	1 unit 1 unit	41A 41A
----	---	---	---	-----	---	-----------------	-----------	--------------------------------	--------	------------------	------------

## With plug-on series resistor and integrated coil circuit

- Suppressor diode integrated at the factory

10	3	2	1	21X	2	1 <sup>2)</sup>	24 110	3RH2122-2KB40-0LA0 3RH2122-2KF40-0LA0	1 1	1 unit 1 unit	41A 41A
----	---	---	---	-----	---	-----------------	-----------	--	--------	------------------	------------

- Varistor integrated at the factory

10	3	2	1	21X	2	1 <sup>2)</sup>	24 110	3RH2122-2LB40-0LA0 3RH2122-2LF40-0LA0	1 1	1 unit 1 unit	41A 41A
----	---	---	---	-----	---	-----------------	-----------	--	--------	------------------	------------

## With integrated coil circuit (varistor integrated in electronics at the factory)

10	3	2	1	22E	2	2 <sup>2)</sup>	24 ... 34 72 ... 125	3RH2122-2XB40-0LA2 3RH2122-2XF40-0LA2	1 1	1 unit 1 unit	41A 41A
----	---	---	---	-----	---	-----------------	-------------------------	--	--------	------------------	------------

<sup>1)</sup> It is not possible to mount an auxiliary switch.

<sup>2)</sup> 4-pole auxiliary switch according to EN 50005 can be mounted.

Accessories, see page 3/71 onwards.

Other voltages according to page 3/69 on request.

## Switching devices – Contactors and contactor assemblies – Special applications

Contactors for special applications

Contactors for railway applications

### 3TH4 contactor relays, 8-pole

#### Overview

##### Standards

IEC 60947-5-1

Terminal covers may have to be fitted onto the connecting bars, depending on the configuration with other devices.

##### Ambient temperature

The permissible ambient temperature for operation of the contactors (across the full solenoid coil operating range) is -50 to +70 °C. Uninterrupted duty at temperatures < -25 °C and > +55 °C reduces the mechanical endurance, the current carrying capacity of the conducting paths and the switching frequency.

A clearance of 10 mm is required for side-by-side mounting at ambient temperatures > 55 °C. There is no need to reduce the technical specifications.

#### Application

For operation in installations which are subject both to considerable variations in the control voltage and to high ambient temperatures, e.g. in railway applications.

##### Control and auxiliary circuits

The solenoid coils of the contactor relays have an extended coil operating range from 0.7 to 1.25 x  $U_s$  and are fitted as standard with varistors to provide protection against overvoltage. The opening delay times are consequently 2 to 5 ms longer than for standard contactors.

#### Technical specifications

More information	
Technical specifications, see <a href="https://support.industry.siemens.com/cs/ww/en/ps/16176/td">https://support.industry.siemens.com/cs/ww/en/ps/16176/td</a> FAQs, see <a href="https://support.industry.siemens.com/cs/ww/en/ps/16176/faq">https://support.industry.siemens.com/cs/ww/en/ps/16176/faq</a>	Manuals, see <a href="https://support.industry.siemens.com/cs/ww/en/ps/16176/man">https://support.industry.siemens.com/cs/ww/en/ps/16176/man</a>
Contactors relays	Type <b>3TH42</b>
General data	
<b>Permissible ambient temperature</b>	
• During operation	°C -50 ... +70 <sup>1)</sup>
• During storage	°C -55 ... +80
Control	
<b>Solenoid coil operating range</b>	
	0.7 ... 1.25 x $U_s$
<b>Power consumption of the solenoid coils</b> (for cold coil and 1.0 x $U_s$ )	
For cold coil: Closing = Closed	W 5.2
<b>Permissible residual current of the electronics</b> (with 0 signal)	
• DC operation	≤ 10 mA x (24 V/ $U_s$ )
<b>Operating times within operating range</b>	
Total break time = Opening delay + Arcing time	
• DC operation	Closing delay ms 40 ... 200
	Opening delay ms 20 ... 30
• Arcing time	ms 10 ... 20

<sup>1)</sup> Side-by-side mounting with 10 mm clearance.

All details and technical specifications not mentioned here are identical to those of the 3TH4 basic units, see [page 5/14 onwards](#).

## Switching devices – Contactors and contactor assemblies – Special applications

Contactors for special applications

Contactors for railway applications

## 3TH4 contactor relays, 8-pole

## Selection and ordering data

DC operation 

3TH4244-0L..

Contacts	Rated operational current $I_e/AC-15/AC-14$				Contacts <sup>1)</sup> Ident. No. according to EN 50011		Version	Rated control supply voltage $U_s$	Screw terminals 	PU (UNIT, SET, M)	PS*	PG
	230 V	400 V	500 V	690 V								
Number	A	A	A	A			NO	NC	V DC	Article No.	Price per PU	
<b>For screw fixing and snap-on mounting on TH 35 DIN rail</b>												
<b>With integrated coil circuit (varistor integrated at the factory)</b>												
8	10	6	4	2	44E	4	4	24 110	3TH4244-0LB4 3TH4244-0LF4	1 1	1 unit 1 unit	41A 41A
8	10	6	4	2	53E	5	3	24 110	3TH4253-0LB4 3TH4253-0LF4	1 1	1 unit 1 unit	41A 41A
8	10	6	4	2	62E	6	2	24 110	3TH4262-0LB4 3TH4262-0LF4	1 1	1 unit 1 unit	41A 41A

<sup>1)</sup> No expansion contacts can be fitted.Other voltages [according to page 5/19](#) on request.Accessories, [see page 5/20](#).



## Switching devices – Contactors and contactor assemblies – Special applications

### Contactors for special applications

### Contactors for railway applications

#### 3TC contactors for switching DC voltage, 2-pole

##### Overview

##### Standards

IEC 60947-4-1

##### Protecting connections against short circuit, overload and overvoltage

All connections must generally be protected against overload and short circuits using suitable measures. Different constraints must be considered depending on the type of connection:

##### Short-circuit and overload protection of main connections

For information on the protection of a free-standing contactor, see the [technical product data sheet](#).

For more information on device combinations such as contactor with overload relay or contactor with circuit breaker as motor feeder, refer to

- [Digital Configuration Manual for load feeders](#)
- [Configuration Manual for load feeders](#)

##### Short-circuit and overload protection of auxiliary connections

For information on the protection of auxiliary contacts, see the [technical product data sheet](#).

##### Short-circuit and overload protection of control supply voltage or supply voltage connections

First of all, the relevant standards and regulations for configuring control panels and the parts and components installed in them must be taken into account, for example for cable dimensioning.

One possible protection for these circuits could be the selection of a suitable power supply, i.e. one with a current-limiting function. In the selection of the source and the connecting cable, the load characteristics of the contactor must be considered (short-time inrush current peaks for solid-state contactor operating mechanisms, switch-on power, holding power). The same applies to the selection of suitable protection devices.

If there are further switching elements in the circuit, such as the auxiliary contact system of an overload relay that operates the contactor, the short-circuit protection necessary for this must also be considered.

For further recommendations, e.g. the use of miniature circuit breakers or circuit breakers for equipment in control circuits, see [Control panel tip – Selecting and dimensioning suitable power supplies quickly and reliably](#).

##### Protection against overvoltage at the control supply voltage connection

The 3TC contactors for railway applications are fitted as standard with varistors against overvoltage.

##### Ambient temperature

The permissible ambient temperature for operation of the contactors (across the full solenoid coil operating range) is -50 to +70 °C. Uninterrupted duty at temperatures < -25 °C and > +55 °C reduces the mechanical endurance, the current carrying capacity of the conducting paths and the switching frequency.

A clearance of 10 mm is required for side-by-side mounting of size 2 contactors at ambient temperatures > 55 °C. There is no need to reduce the technical specifications.

##### Series resistor

The DC solenoid systems of the 3TC contactors must be modified (to holding coil) by means of a series resistor. This series resistor is supplied separately packed with the contactors.

With types 3TC48, the series resistor must be attached onto the right-hand side of the auxiliary switch by means of the enclosed mounting parts and sets of links provided, while in the case of the 3TC44 it must be mounted and wired between the contactor poles. With types 3TC52 and 3TC56, the series resistor must be attached separately next to the contactors.

##### Fitting auxiliary contacts and mounting additional auxiliary switches

##### Features in the delivery state

The 3TC contactors are equipped with two lateral auxiliary switches with four auxiliary contacts. Of those contacts, one NC contact is required if a series resistor is used (2 NO + 1 NC).

##### Expansion possibilities

Contactors with AC operation can be expanded using auxiliary switches; the permissible configuration must be observed.

##### Reversing contactors

With the 3TC52 and 3TC56 contactors, the series resistor must be connected using an additional K2 reversing contactor. This contactor is automatically included in the scope of supply.

##### Application

For operation in installations which are subject both to considerable variations in the control voltage and to high ambient temperatures, e.g. in railway applications.

##### Control and auxiliary circuits

The solenoid coils of the contactors have an extended coil operating range from 0.7 to 1.25 x  $U_s$ .

## Switching devices – Contactors and contactor assemblies – Special applications

Contactors for special applications

Contactors for railway applications

## 3TC contactors for switching DC voltage, 2-pole

## Technical specifications

## More information

Technical specifications, see  
<https://support.industry.siemens.com/cs/ww/en/ps/16180/td>

Manuals, see  
<https://support.industry.siemens.com/cs/ww/en/ps/16180/man>

Type		<b>3TC44</b>	<b>3TC48</b>	<b>3TC52</b>	<b>3TC56</b>
Size		<b>2</b>	<b>4</b>	<b>8</b>	<b>12</b>
<b>General data</b>					
<b>Ambient temperature</b>					
• During operation	°C	-40 ... +70			
<b>Control</b>					
<b>Solenoid coil operating range</b>		0.7 ... 1.25 x $U_s$			
<b>Power consumption of the solenoid coils</b>		For cold coil and 1.0 x $U_s$			
• Closing	W	48	26	40	130
• Closed	W	13	14	21	59

All details and technical specifications not mentioned here are identical to those of the basic units of the 3TC contactors, see [page 4/72](#).

## Switching devices – Contactors and contactor assemblies – Special applications

Contactors for special applications

Contactors for railway applications

### 3TC contactors for switching DC voltage, 2-pole

#### Selection and ordering data

##### DC operation

3TC44: For screw fixing and snap-on mounting on 35 mm DIN rail

3TC48 to 3TC56: For screw fixing

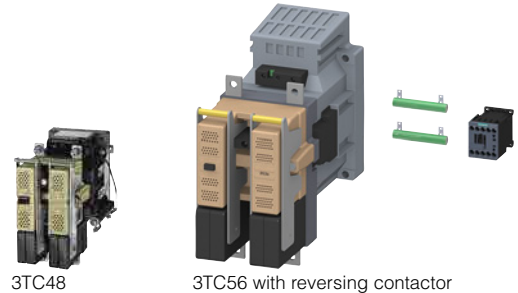

3TC48

3TC56 with reversing contactor

Size	Utilization category	Rated operational current $I_e$ at	Rated power of loads at					Auxiliary contacts <sup>1)</sup>		Rated control supply voltage $U_s$	Screw terminals 	PU (UNIT, SET, M)	PS*	PG
			750 V	220 V	440 V	600 V	750 V	Version						
		A	kW	kW	kW	kW	NO	NC	V DC	Article No.	Price per PU			

#### Contactors for switching DC voltage

##### With integrated coil circuit (varistor integrated at the factory)

2	DC-1	32	7	14	19.2	24	2	1 <sup>2)</sup>	24	<b>3TC4417-0LB4</b>	1	1 unit	41B
	DC-3/DC-5	7.5	5	9	9	4			110	<b>3TC4417-0LF4</b>	1	1 unit	41B

##### With laterally mounted coil circuit (varistor mounted externally in additional auxiliary switch enclosure on the contactor)

4	DC-1	75	16.5	33	45	56	2	1 <sup>2)</sup>	24	<b>3TC4817-0LB4</b>	1	1 unit	41B
	DC-3/DC-5	75	13	27	38	45			110	<b>3TC4817-0LF4</b>	1	1 unit	41B
8	DC-1	170	48	97	132	165	2	1 <sup>2)</sup>	24	<b>3TC5217-0LB4</b>	1	1 unit	41B
	DC-3/DC-5	170	41	82	110	110			110	<b>3TC5217-0LF4</b>	1	1 unit	41B
12	DC-1	400	88	176	240	300	2	1 <sup>2)</sup>	24	<b>3TC5617-0LB4</b>	1	1 unit	41B
	DC-3/DC-5	400	70	140	200	250			110	<b>3TC5617-0LF4</b>	1	1 unit	41B

<sup>1)</sup> No expansion auxiliary contacts can be fitted.

<sup>2)</sup> One NC contact used for series resistor.

Other rated control supply voltages according to page 4/79 on request.

#### Accessories

Accessories, see basic units of the 3TC contactors, page 4/79 onwards.

##### Spare parts for contactors with extended operating range

For contactor	Remarks	Rated control supply voltage $U_s$	Article No.	Price per PU	PU (UNIT, SET, M)	PS*	PG
Size	Type	V DC					
<b>Arc chutes</b>							
2	3TC4417-0L..	With recess for resistor mounting	--	<b>3TY2442-0B</b>	1	1 unit	41B
<b>Solenoid coils</b>							
2	3TC44	With series resistor, without varistor	24 110	<b>3TY6443-0LB4</b> <b>3TY6443-0LF4</b>	1 1	1 unit 1 unit	41B 41B
4	3TC48		24 110	<b>3TY6483-0LB4</b> <b>3TY6483-0LF4</b>	1 1	1 unit 1 unit	41B 41B

All spare parts not mentioned here are identical to those of the basic units of the 3TC contactors, see page 4/79.

## Switching devices – Contactors and contactor assemblies – Special applications

### Contactors for special applications

#### 3TC contactors for switching DC voltage, 1- and 2-pole

##### Overview

##### **3TC4 and 3TC5**

IEC 60947-1, IEC 60947-4-1, IEC 60947-5-1 (auxiliary switches)

The DC motor ratings given in the tables are applicable to the DC-3 and DC-5 utilization categories with 2-pole switching of the load or with the two conducting paths of the contactor connected in series.

One contactor conducting path can switch full power up to 220 V. For voltages over 220 V, the two conducting paths are to be switched in series, [see Rated data of the main contacts, page 4/74](#).

##### Surge suppression

Contactors (not for railway applications) supplied without a coil circuit can be retrofitted with RC elements, varistors, diodes or diode assemblies (combination of diode and Zener diode for short break times) for damping switching overvoltages in the coil, [see page 4/80 onwards](#).

##### Fitting auxiliary contacts and mounting additional auxiliary switches

- Features in the delivery state:  
The 3TC contactors are equipped with two lateral auxiliary switches with four auxiliary contacts. Of those contacts, one NC contact is required if a series resistor is used (2 NO + 1 NC).
- Expansion possibilities:  
Contactors with AC operation can be expanded using auxiliary switches; the permissible configuration must be observed.

##### **3TC7**

IEC 60947-4-1

The contactors are suitable for switching and controlling DC motors as well as all other DC loads.

The solenoid excitation is configured for a particularly large operating range. It is between 0.7 or 0.8 and  $1.2 \times U_s$ .

3TC74 contactors can be used at up to 750 V/400 A and 50 Hz in AC-1 operation. For voltages over 750 V, the two conducting paths (3TC74: two contactors) are to be switched in series, [see Rated data of the main contacts, page 4/76](#).

##### Application

The contactors are suitable for switching and controlling DC motors as well as all other DC circuits.

A version with a particularly large solenoid coil operating range is available for operation in electrically driven vehicles and in switchgear subject to large fluctuations in actuating voltage ([see page 4/70](#)).

## Switching devices – Contactors and contactor assemblies – Special applications

### Contactors for special applications

#### 3TC contactors for switching DC voltage, 1- and 2-pole

##### Technical specifications

###### More information

Technical specifications, see  
<https://support.industry.siemens.com/cs/ww/en/ps/16181/td>  
 FAQs, see  
<https://support.industry.siemens.com/cs/ww/en/ps/16181/faq>

Manuals, see  
<https://support.industry.siemens.com/cs/ww/en/ps/16181/man>

Type	3TC4 and 3TC7		3TC5
<b>Rated data of the auxiliary contacts</b>			
<b>Rated insulation voltage <math>U_i</math></b> (pollution degree 3)	V	690	
<b>Conventional thermal current <math>I_{th}</math> = rated operational current <math>I_e/AC-12</math></b>	A	10	10
<b>AC load</b>			
<b>Rated operational current <math>I_e/AC-15/AC-14</math></b>			
• At rated operational voltage $U_e$			
	24 V A	10	10
	110 V A	10	10
	125 V A	10	10
	220 V A	6	6
	230 V A	5.6	5.6
	380 V A	4	4
	400 V A	3.6	3.6
	500 V A	2.5	2.5
	660 V A	2.5	2.5
	690 V A	--	--
<b>DC load</b>			
<b>Rated operational current <math>I_e/DC-12</math></b>			
• At rated operational voltage $U_e$			
	24 V A	10	10
	60 V A	10	10
	110 V A	3.2	8
	125 V A	2.5	6
	220 V A	0.9	2
	440 V A	0.33	0.6
	600 V A	0.22	0.4
<b>Rated operational current <math>I_e/DC-13</math></b>			
• At rated operational voltage $U_e$			
	24 V A	10	10
	48 V A	5	5
	110 V A	1.14	2.4
	125 V A	0.98	2.1
	220 V A	0.48	1.1
	440 V A	0.13	0.32
	600 V A	0.07	0.21
<b>3TC44 to 3TC56</b>			
<b>Ⓢ and Ⓣ rated data of the auxiliary contacts</b>			
<b>Rated voltage, max.</b>	V AC	600	
<b>Switching capacity</b>		A 600, P 600	

# Switching devices – Contactors and contactor assemblies – Special applications

## Contactors for special applications

### 3TC contactors for switching DC voltage, 1- and 2-pole

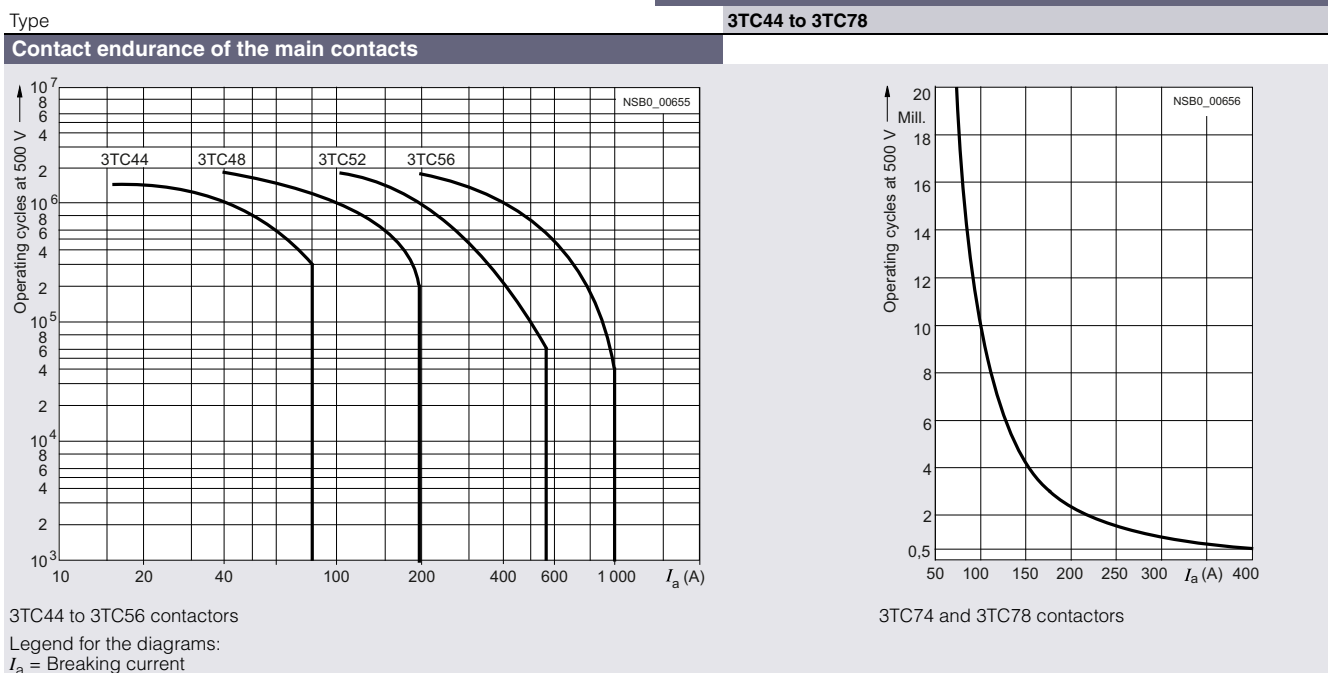

Contactor	Type Size	3TC44 2	3TC48 4	3TC52 8	3TC56 12	
<b>General data</b>						
<b>Dimensions (W x H x D)</b>						
<ul style="list-style-type: none"> <li>DC operation</li> <li>AC operation</li> </ul>		mm	70 x 85 x 141	100 x 183 x 180	135 x 238 x 232	160 x 279 x 310
		mm	70 x 85 x 100	100 x 183 x 154	135 x 238 x 200	160 x 279 x 251
<b>Permissible mounting position</b>						
The contactors are designed for operation on a vertical mounting surface.						
<b>Mechanical endurance</b>		Operating cycles		10 million		
<b>Electrical endurance</b>		See the endurance diagram above				
<b>Rated insulation voltage <math>U_i</math></b> (pollution degree 3)		V		800		
<b>Rated impulse withstand voltage <math>U_{imp}</math></b>		kV		8		
<b>Protective separation</b> between the coil and the main contacts according to IEC 60947-1, Annex N		V		Up to 300		
<b>Mirror contacts<sup>1)</sup></b> A mirror contact is an auxiliary NC contact that cannot be closed simultaneously with an NO main contact.		Yes, according to IEC 60947-4-1, Annex F				
<b>Permissible ambient temperature</b>		°C		-25 ... +55		
<ul style="list-style-type: none"> <li>During operation</li> <li>During storage</li> </ul>		°C		-50 ... +80		
<b>Short-circuit protection</b>						
<b>Main circuit</b>						
<ul style="list-style-type: none"> <li>Type of coordination "1"</li> <li>Type of coordination "2"</li> </ul>		2 x 3NA3020 (50 A) in series		2 x 3NA31.. (160 A) in series		
		2 x 3NA3020 (50 A) in series		2 x 3NA31.. (63 A) in series		
				3NE1332-4D (400 A)		
				3NE1332-4D (400 A)		
				2 x 3NE1330-4D (315 A) parallel		
				2 x 3NE1330-4D (315 A) parallel		
<b>Auxiliary circuit</b> (short-circuit current $I_k \leq 1$ kA)						
<ul style="list-style-type: none"> <li>Fuse links, operating class gG: DIAZED, type 5SB; NEOZED, type 5SE</li> <li>Miniature circuit breaker with C characteristic</li> </ul>		A		16		
		A		10		

<sup>1)</sup> For 3TC44, one NC contact each must be connected in series for the right and left auxiliary switch respectively.

Rated data of the auxiliary contacts, see page 4/72.

# Switching devices – Contactors and contactor assemblies – Special applications

## Contactors for special applications

### 3TC contactors for switching DC voltage, 1- and 2-pole

Type			3TC44	3TC48	3TC52	3TC56
Size			2	4	8	12
<b>Control</b>						
<b>Solenoid coil operating range</b>						
• DC operation			0.7 ... 1.25 x $U_s$			
• AC operation			0.8 ... 1.1 x $U_s$			
<b>Power consumption of the solenoid coils</b> (for cold coil and 1.0 x $U_s$ )						
• DC operation	Closing = Closed	W	10	19	30	86
• AC operation, 50 Hz coil	Closing	VA/p.f.	68/0.86	300/0.5	640/0.48	1 780/0.3
	Closed	VA/p.f.	10/0.29	26/0.24	46/0.23	121/0.22
• AC operation, 60 Hz coil	Closing	VA/p.f.	95/0.79	365/0.45	730/0.38	2 140/0.3
	Closed	VA/p.f.	12/0.3	35/0.26	56/0.24	140/0.29
• AC operation, 50/60 Hz coil	Closing at 50/60 Hz	VA/p.f.	79/73/0.83/0.78	--	--	--
	Closed at 50/60 Hz	VA/p.f.	11/9/0.28/0.27	--	--	--
<b>Rated data of the main contacts</b>						
<b>Load rating with DC</b>						
<b>Utilization category DC-1 (<math>L/R \leq 1</math> ms)</b>						
• Rated operational currents $I_e$ (at 55 °C)	Up to $U_e$ 750 V	A	32	75	220	400
• Minimum conductor cross-section		mm <sup>2</sup>	6	25	95	240
• Rated power at $U_e$ ( $\leq 220$ V DC: one conducting path, > 220 V DC: two conducting paths in series)	At 220 V	kW	7	16.5	48	88
	440 V	kW	14	33	97	176
	600 V	kW	19.2	45	132	240
	750 V	kW	24	56	165	300
<b>Utilization category DC-3 and DC-5, shunt-wound and series-wound motors (<math>L/R \leq 15</math> ms)</b>						
• Rated operational currents $I_e$ (at 55 °C)	Up to 220 V	A	32	75	220	400
	440 V	A	29	75	220	400
	600 V	A	21	75	220	400
	750 V	A	7.5	75	170	400
• Rated power at $U_e$ ( $\leq 220$ V DC: one conducting path, > 220 V DC: two conducting paths in series)	At 110 V	kW	2.5	6.5	20	35
	220 V	kW	5	13	41	70
	440 V	kW	9	27	82	140
	600 V	kW	9	38	110	200
	750 V	kW	4	45	110	250
<b>Conductor cross-sections</b>						
<b>Main conductors</b> (1 or 2 conductors can be connected)			<b>Screw terminals</b>			
• Solid	mm <sup>2</sup>		2 x (2.5 ... 10)	2 x (6 ... 16)	--	
• Finely stranded with end sleeve	mm <sup>2</sup>		2 x (1.5 ... 4)	--		
• Stranded with cable lug	mm <sup>2</sup>		2 x 16	2 x 35	2 x 120	2 x 150
• Pin cable lug to DIN 46231	mm <sup>2</sup>		2 x (1 ... 6)	--		
• Busbars	mm		--	15 x 2.5	25 x 4	2 x (25 x 3)
• Terminal screw			M5	M6	M10	
<b>Auxiliary conductors</b> (1 or 2 conductors can be connected)						
• Solid	mm <sup>2</sup>		2 x (1 ... 2.5)			
• Finely stranded with end sleeve	mm <sup>2</sup>		2 x (0.75 ... 1.5)			

Rated data of the auxiliary contacts, see page 4/72.

# Switching devices – Contactors and contactor assemblies – Special applications

## Contactors for special applications

### 3TC contactors for switching DC voltage, 1- and 2-pole

Type		3TC74	3TC78
Design		1-pole contactors	2-pole contactors
<b>General data</b>			
<b>Dimensions (W x H x D)</b>	mm	78 x 352 x 276	160 x 366 x 290
<b>Permissible mounting position</b>	The contactors are designed for operation on a vertical mounting surface.		
<b>Mechanical endurance</b>	Operating cycles	30 million	
<b>Electrical endurance</b>		See page 4/73	
<b>Rated insulation voltage <math>U_i</math></b> (pollution degree 3)	V	1 500	
<b>Rated impulse withstand voltage <math>U_{imp}</math></b>	kV	8	
<b>Protective separation</b> between the coil and the main contacts according to IEC 60947-1, Annex N	V	630	
<b>Mirror contacts<sup>1)</sup></b> A mirror contact is an auxiliary NC contact that cannot be closed simultaneously with an NO main contact.		Yes, according to IEC 60947-4-1, Annex F	
<b>Permissible ambient temperature</b>	°C	-25 ... +55	
<b>Short-circuit protection</b>			
<b>Main circuit</b>			
• Type of coordination "1"	A	2 x 3NE1330-4D (315 A) parallel	2 x 3NE1330-5E (315 A) parallel
• Type of coordination "2"	A	2 x 3NE1330-4D (315 A) parallel	2 x 3NE1330-5E (315 A) parallel
<b>Auxiliary circuit</b> (Short-circuit current $I_k \leq 1$ kA)			
• Fuse links, operating class gG: DIAZED, type 5SB; NEOZED, type 5SE	A	16	
• Miniature circuit breaker with C characteristic	A	10	
<b>Control</b>			
<b>Solenoid coil operating range</b>			
• DC operation	At $U_c = 24$ V	0.8 ... 1.2 x $U_s$	
	At $U_c > 24$ V	0.7 ... 1.2 x $U_s$	
• AC operation	At $U_c = 24$ V	0.7 ... 1.15 x $U_s$	
	At $U_c > 24$ V	0.7 ... 1.14 x $U_s$	
<b>Power consumption of the solenoid coils</b> (for cold coil and $1.0 \times U_s$ )			
• DC operation	Closing = Closed	W	46
			92
• AC operation, 50 Hz	Closing = Closed	VA	80
			160
		P.f.	0.95

<sup>1)</sup> For 3TC78, one auxiliary NC contact each of the right and left conducting paths must be connected in series.

Rated data of the auxiliary contacts, see page 4/72.



# Switching devices – Contactors and contactor assemblies – Special applications

## Contactors for special applications

### 3TC contactors for switching DC voltage, 1- and 2-pole

Type	3TC74		3TC78	
Design	1-pole contactors		2-pole contactors	
<b>Rated data of the main contacts</b>				
<b>Load rating with DC</b>				
<b>Utilization category DC-1 (<math>L/R \leq 1</math> ms)</b>				
• Rated operational current $I_e$ /DC-1 (at 55 °C)	A	500		
• Minimum conductor cross-section	mm <sup>2</sup>	2 x 150		
• Rated power	At 220 V	kW	110	
	440 V	kW	220	
	600 V	kW	300	
	750 V	kW	375	
	1 200 V	kW	--	600
(<math>\leq 750 V DC: one conducting path, > 750 V DC: two conducting paths in series)	1 500 V	kW	--	750
• Critical currents, without arc extinction	At 440 V	A	$\leq 7$	--
	600 V	A	$\leq 13$	--
	750 V	A	$\leq 15$	--
	$\leq 800$ V	A	--	$\leq 7$
	1 200 V	A	--	$\leq 13$
	1 500 V	A	--	$\leq 15$
<b>Utilization category DC-3 and DC-5, shunt-wound and series-wound motors (<math>L/R \leq 15</math> ms)</b>				
• Rated operational current $I_e$ (at 55 °C)	A	400		
• Rated power at $U_e$	At 110 V	kW	35	
	220 V	kW	70	
	440 V	kW	140	
	600 V	kW	200	
	750 V	kW	250	
	1 200 V	kW	--	400
	1 500 V	kW	--	500
<b>Permissible rated current for regenerative braking</b>				
At 110 ... 600 V	A	400		
<b>Conductor cross-sections</b>				
<b>Main conductors</b> (1 or 2 conductors can be connected)				
• Stranded with cable lug	mm <sup>2</sup>	2 x ... 150	 <b>Screw terminals</b>	
• Busbars	mm	2 x (30 x 4)		
<b>Auxiliary conductors</b> (1 or 2 conductors can be connected)				
• Solid	mm <sup>2</sup>	1 ... 2.5		
• Finely stranded with end sleeve	mm <sup>2</sup>	0.75 ... 1.5		

Rated data of the auxiliary contacts, [see page 4/72](#).

# Switching devices – Contactors and contactor assemblies – Special applications

## Contactors for special applications

### 3TC contactors for switching DC voltage, 1- and 2-pole

#### Selection and ordering data

DC operation  or AC operation, 50 Hz 



3TC44



3TC48

Size	Utilization category <sup>1)</sup>	Operational current $I_e$ <sup>2)</sup>	Ratings of DC motors at					Auxiliary contacts <sup>3)</sup>		Rated control supply voltage $U_s$	Screw terminals 	PU (UNIT, SET, M)	PS*	PG
			110 V	220 V	440 V	600 V	750 V	Version						
A			kW	kW	kW	kW	kW	NO	NC	V	Article No.	Price per PU		

#### 3TC44 to 3TC56 2-pole contactors · Operational voltage up to 750 V

##### DC operation

##### For screw fixing and snap-on mounting on TH 35 DIN rail

2	DC-3, DC-5	32	2.5	5	9	9	4	2	2	24 DC 110 DC 220 DC	<b>3TC4417-0AB4</b> <b>3TC4417-0AF4</b> <b>3TC4417-0AM4</b>	1 1 1	1 unit 1 unit 1 unit	41B 41B 41B
---	---------------	----	-----	---	---	---	---	---	---	---------------------------	---	-------------	----------------------------	-------------------

##### For screw fixing

4	DC-3, DC-5	75	6.5	13	27	38	45	2	2	24 DC 110 DC 220 DC	<b>3TC4817-0AB4</b> <b>3TC4817-0AF4</b> <b>3TC4817-0AM4</b>	1 1 1	1 unit 1 unit 1 unit	41B 41B 41B
8	DC-3, DC-5	220 <sup>4)</sup>	20	41	82	110	110	2	2	24 DC 110 DC 220 DC	<b>3TC5217-0AB4</b> <b>3TC5217-0AF4</b> <b>3TC5217-0AM4</b>	1 1 1	1 unit 1 unit 1 unit	41B 41B 41B
12	DC-3, DC-5	400	35	70	140	200	250	2	2	24 DC 110 DC 220 DC	<b>3TC5617-0AB4</b> <b>3TC5617-0AF4</b> <b>3TC5617-0AM4</b>	1 1 1	1 unit 1 unit 1 unit	41B 41B 41B

##### AC operation, 50 Hz

##### For screw fixing and snap-on mounting on TH 35 DIN rail

2	DC-3, DC-5	32	2.5	5	9	9	4	2	2	220/230 AC <sup>5)</sup> 110/110 AC	<b>3TC4417-0BP0</b> <b>3TC4417-0BF0</b>	1 1	1 unit 1 unit	41B 41B
4	DC-3, DC-5	75	6.5	13	27	38	45	2	2	220/230 AC <sup>5)</sup> 110 AC	<b>3TC4817-0BP0</b> <b>3TC4817-0BF0</b>	1 1	1 unit 1 unit	41B 41B
8	DC-3, DC-5	220 <sup>4)</sup>	20	41	82	110	110	2	2	220/230 AC <sup>5)</sup> 110 AC	<b>3TC5217-0BP0</b> <b>3TC5217-0BF0</b>	1 1	1 unit 1 unit	41B 41B
12	DC-3, DC-5	400	35	70	140	200	250	2	2	220/230 AC <sup>5)</sup> 110 AC	<b>3TC5617-0BP0</b> <b>3TC5617-0BF0</b>	1 1	1 unit 1 unit	41B 41B

<sup>1)</sup> Permissible load for DC-1 utilization category, see detailed technical specifications in the Reference Manual.

<sup>2)</sup> The following rated operational currents are permitted for reversing duty with 3TC44 to 3TC56 contactors:

Contactors	Rated operational voltage	
Type	110 V, 220 V	440 V
3TC44	32 A	7 A
3TC48	75 A	75 A
3TC52	170 A	170 A
3TC56	400 A	400 A

<sup>3)</sup> The fitting of auxiliary switches cannot be altered on DC-operated contactors.

<sup>4)</sup> At > 600 V:  $I_e = 170$  A.

<sup>5)</sup> Operating range at 220 V AC: 0.85 to 1.15 ×  $U_s$ ;  
lower operating range limit according to IEC 60947.

Other rated control supply voltages according to page 4/79 on request.

Accessories, see page 4/79 onwards.

Spare parts, see page 4/81.

## Switching devices – Contactors and contactor assemblies – Special applications

### Contactors for special applications

#### 3TC contactors for switching DC voltage, 1- and 2-pole

**DC operation**  or **AC operation, 50 Hz** 

For screw fixing



3TC74



3TC78

Size	Utilization category <sup>1)</sup>	Operational current $I_e$	Ratings of DC motors at							Auxiliary contacts <sup>2)</sup> Version	Rated control supply voltage $U_s$	Screw terminals 	PU (UNIT, SET, M)	PS*	PG			
			110 V	220 V	440 V	600 V	750 V	1200V	1500V									
			A	kW	kW	kW	kW	kW	kW	kW	NO	NC	V	Article No.	Price per PU			
<b>3TC74 1-pole contactors · Operational voltage up to 750 V</b>																		
<b>DC operation</b>																		
12	DC-3, DC-5	400	35	70	140	200	250	--	--	4	4	24 DC	110 DC	<b>3TC7414-0EB</b>	1	1 unit	41B	
														<b>3TC7414-0EF</b>	1	1 unit	41B	
<b>AC operation, 50 Hz</b>																		
12	DC-3, DC-5	400	35	70	140	200	250	--	--	4	4	230/220 AC <sup>3)</sup>		<b>3TC7414-1CM</b>	1	1 unit	41B	
<b>3TC78 2-pole contactors · Operational voltage up to 1 500 V</b>																		
<b>DC operation</b>																		
12	DC-3, DC-5	400	35	70	140	200	250	400	500	4	4	24 DC	110 DC	<b>3TC7814-0EB</b>	1	1 unit	41B	
														<b>3TC7814-0EF</b>	1	1 unit	41B	
<b>AC operation, 50 Hz</b>																		
12	DC-3, DC-5	400	35	70	140	200	250	400	500	4	4	230/220 AC <sup>3)</sup>		<b>3TC7814-1CM</b>	1	1 unit	41B	

<sup>1)</sup> Permissible load for DC-1 utilization category, see detailed technical specifications in the Reference Manual.

<sup>2)</sup> The fitting of auxiliary switches cannot be altered on DC-operated contactors.

<sup>3)</sup> Upper operating range limit at 230 V AC:  $1.14 \times U_s$ .

Other rated control supply voltages according to page 4/79 on request.

Spare parts, see page 4/81.

# Switching devices – Contactors and contactor assemblies – Special applications

## Contactors for special applications

### 3TC contactors for switching DC voltage, 1- and 2-pole

#### Options

**Rated control supply voltages,  
possible on request (change of the 10th and 11th digits of the article number)**

Delivery time on request

Rated control supply voltage $U_c$	Contactor type	3TC44	3TC48	3TC52/3TC56	3TC74/3TC78
<b>DC operation</b>					
24 V DC		B4	B4	B4	B
48 V DC		W4	W4	--	--
60 V DC		E4	E4	--	--
110 V DC		F4	F4	F4	F
125 V DC		G4	G4	--	--
220 V DC		M4	M4	M4	M
230 V DC		P4	P4	--	--
<b>AC operation</b>					
<b>Solenoid coils for 50 Hz</b>					
24 V AC		B0	B0	--	--
110 V AC		F0	F0	F0	--
230/220 V AC		P0 <sup>1)</sup>	P0 <sup>1)</sup>	P0 <sup>1)</sup>	M <sup>2)</sup>
240 V AC		U0	U0	--	--
<b>Solenoid coils for 50/60 Hz</b>					
24 V AC		C2	--	--	--
110 V AC		G2	--	--	--
120 V AC		K2	--	--	--
220 V AC		N2	--	--	--
230 V AC		L2	--	--	--

<sup>1)</sup> Operating range at 220 V AC:  $0.85$  to  $1.15 \times U_{s1}$ ; lower operating range limit according to IEC 60947.

<sup>2)</sup> Upper operating range limit at 230 V AC:  $1.14 \times U_c$ .

#### Accessories



For contactor	Version	Auxiliary switches		Screw terminals	PU (UNIT, SET, M)	PS*	PG				
		Auxiliary contacts	Left					Right			
Size	Type	NO	NC	Article No.	Price per PU						
<b>Second auxiliary switches (for AC operation only)</b>											
4	3TC48	2nd auxiliary switch, left	1	1		--	<b>3TY6501-1K</b>	1	1 unit	41B	
		2nd auxiliary switch, right	1	1	--		<b>3TY6501-1L</b>	1	1 unit	41B	
8 and 12	3TC52, 3TC56	2nd auxiliary switch, left	1	1		--	<b>3TY6561-1K</b>	1	1 unit	41B	
		2nd auxiliary switch, right	1	1	--		<b>3TY6561-1L</b>	1	1 unit	41B	
<b>Solid-state-compatible auxiliary switches</b>											
	2 and 4	3TC44, 3TC48	For operation in dusty atmospheres and in solid-state circuits with rated operational currents $I_e/AC-14$ and DC-13 of 1 ... 300 mA at 3 ... 60 V		2nd auxiliary switch, left or right (replacement for 3TY6561-1U, 3TY6561-1V)	1 CO contact		<b>3TY7561-1UA00</b>	1	1 unit	41B

3TY7561-1UA00

# Switching devices – Contactors and contactor assemblies – Special applications

## Contactors for special applications

### 3TC contactors for switching DC voltage, 1- and 2-pole

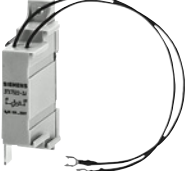
For contactor		Version	Rated control supply voltage $U_s$		Article No.	Price per PU	PU (UNIT, SET, M)	PS*	PG		
Size	Type	V AC	V DC								
<b>Surge suppressors · Varistors</b>											
	2	3TC44 <sup>1)</sup>	<b>Varistors<sup>2)</sup></b>	24 ... 48	24 ... 70	<b>3TX7402-3G</b>		1	1 unit	41B	
			With line spacer,	48 ... 127	70 ... 150						<b>3TX7402-3H</b>
			for mounting on the	127 ... 240	150 ... 250						<b>3TX7402-3J</b>
			coil terminal	240 ... 400	--						<b>3TX7402-3K</b>
				400 ... 600	--						<b>3TX7402-3L</b>
3TX7402-3.	4	3TC48	<b>Varistors<sup>2)</sup></b>	24 ... 48	24 ... 70	<b>3TX7462-3G</b>		1	1 unit	41B	
			For sticking onto	48 ... 127	70 ... 150						<b>3TX7462-3H</b>
			the contactor base	127 ... 240	150 ... 250						<b>3TX7462-3J</b>
			or for mounting	240 ... 400	--						<b>3TX7462-3K</b>
			separately	400 ... 600	--						<b>3TX7462-3L</b>
	8 and 12	3TC52, 3TC56	<b>Varistors</b>	24 ... 48	--	<b>3TX7462-3G</b>		1	1 unit	41B	
			For sticking onto	48 ... 127	--						<b>3TX7462-3H</b>
			the contactor base	127 ... 240	--						<b>3TX7462-3J</b>
			or for mounting	240 ... 400	--						<b>3TX7462-3K</b>
			separately	400 ... 600	--						<b>3TX7462-3L</b>
3TX7462-3.	8 and 12	3TC52, 3TC56	<b>Varistors<sup>2)</sup></b>	--	24 ... 70	<b>3TX7522-3G</b>		1	1 unit	41B	
			For separate screw	--	70 ... 150						<b>3TX7522-3H</b>
			fixing or snapping	--	150 ... 250						<b>3TX7522-3J</b>
			onto TH 35 DIN rail	--	--						
				--	--						
	8 and 12	3TC52, 3TC56	<b>Varistors<sup>2)</sup></b>	24 ... 48	--	<b>3TX7462-3R</b>		1	1 unit	41B	
			For lateral	--	24 ... 70						<b>3TX7522-3R</b>
			snapping onto	48 ... 127	--						<b>3TX7462-3S</b>
			auxiliary switch or	--	70 ... 150						<b>3TX7522-3S</b>
			TH 35 DIN rail	127 ... 240	--						<b>3TX7462-3T</b>
3TX7522-3.	8 and 12	3TC52, 3TC56	<b>RC elements</b>	--	150 ... 250	<b>3TX7522-3T</b>		1	1 unit	41B	
				240 ... 400	--	<b>3TX7462-3U</b>		1	1 unit	41B	
				400 ... 600	--	<b>3TX7462-3V</b>		1	1 unit	41B	
				24 ... 48	--	<b>3TX7522-3R</b>		1	1 unit	41B	
				48 ... 127	--	<b>3TX7522-3S</b>		1	1 unit	41B	
	127 ... 240	--	<b>3TX7522-3T</b>		1	1 unit	41B				
	240 ... 400	--	<b>3TX7522-3U</b>		1	1 unit	41B				
	400 ... 600	--	<b>3TX7522-3V</b>		1	1 unit	41B				

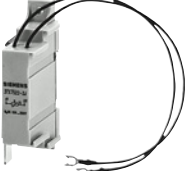
<b>Surge suppressors · RC elements</b>											
	4	3TC48	<b>RC elements</b>	24 ... 48	--	<b>3TX7462-3R</b>		1	1 unit	41B	
			For lateral	--	24 ... 70						<b>3TX7522-3R</b>
			snapping onto	48 ... 127	--						<b>3TX7462-3S</b>
			auxiliary switch or	--	70 ... 150						<b>3TX7522-3S</b>
			TH 35 DIN rail	127 ... 240	--						<b>3TX7462-3T</b>
3TX7462-3., 3TX7522-3.	8 and 12	3TC52, 3TC56	<b>RC elements</b>	--	150 ... 250	<b>3TX7522-3T</b>		1	1 unit	41B	
				240 ... 400	--	<b>3TX7462-3U</b>		1	1 unit	41B	
				400 ... 600	--	<b>3TX7462-3V</b>		1	1 unit	41B	
				24 ... 48	--	<b>3TX7522-3R</b>		1	1 unit	41B	
				48 ... 127	--	<b>3TX7522-3S</b>		1	1 unit	41B	
	127 ... 240	--	<b>3TX7522-3T</b>		1	1 unit	41B				
	240 ... 400	--	<b>3TX7522-3U</b>		1	1 unit	41B				
	400 ... 600	--	<b>3TX7522-3V</b>		1	1 unit	41B				

<b>Surge suppressors · Diodes</b>										
	4 to 12	3TC48, 3TC52, 3TC56	<b>Diode assembly<sup>3)</sup></b>	--	24 ... 250	<b>3TX7462-3D</b>		1	1 unit	41B
			(Diode and Zener diode) for DC solenoid system, for sticking onto the contactor base or for mounting separately							

<sup>1)</sup> The connection piece for mounting the surge suppressor must be bent slightly.

<sup>2)</sup> Includes the peak value of the alternating voltage on the DC side.

<sup>3)</sup> Not for DC operation.







For contactor		Version			Article No.	Price per PU	PU (UNIT, SET, M)	PS*	PG
Size	Type								
	2	3TC44	For protection against inadvertent contact with exposed busbar connections (1 set = 2 units)	--	<b>3TY2444-0B</b>		1	1 unit	41B
	6	3TC48	For protection against inadvertent contact with exposed busbar connections	M6	<b>3TX6506-3B</b>		1	1 unit	41B
	8 and 12	3TC52, 3TC56	Can be screwed on free screw end; covers one busbar connection (1 set = 6 units)	M10	<b>3TX6546-3B</b>		1	1 unit	41B

# Switching devices – Contactors and contactor assemblies – Special applications

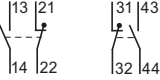
## Contactors for special applications

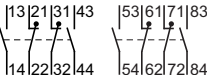
### 3TC contactors for switching DC voltage, 1- and 2-pole

#### Spare parts

For contactor	Version	Auxiliary contacts	Auxiliary switches Left	Right	Screw terminals	PU (UNIT, SET, M)	PS*	PG
Size	Type	NO	NC		Article No.	Price per PU		
<b>Auxiliary switches</b>								
<b>For lateral mounting</b>								
	2 and 4	3TC44, 3TC48*	Auxiliary switch (replacement for 3TY6501-1A, 3TY6501-1B)	1	1		<b>3TY6501-1AA00</b>	1 1 unit 41B
	8 and 12	3TC52, 3TC56	Auxiliary switch, left	1	1		<b>3TY6561-1A</b>	1 1 unit 41B
			Auxiliary switch, right	1	1		<b>3TY6561-1B</b>	1 1 unit 41B
	12	3TC74	Auxiliary switch	4	4		<b>3TY2741-2J</b>	1 1 unit 41B
	12	3TC78	Auxiliary switch, left	2	2		<b>3TY2781-2C</b>	1 1 unit 41B
			Auxiliary switch, right	2	2		<b>3TY2781-2D</b>	1 1 unit 41B
<b>Surge suppressors · Varistors</b>								
12	3TC7	For sticking onto the contactor base	24 110		<b>3TX2746-2F</b> <b>3TX2746-2G</b>		1 1 unit 41B 1 1 unit 41B	
<b>Solenoid coils</b>								
<b>DC operation<sup>1)</sup></b>								
2	3TC44	--			<b>3TY6443-0B..</b>			
4	3TC48				<b>3TY6483-0B..</b>			
8	3TC52				<b>3TY6523-0B..</b>			
12	3TC56				<b>3TY6563-0B..</b>			
<b>AC operation<sup>1)</sup></b>								
2	3TC44	--			<b>3TY7403-0A..</b>			
4	3TC48				<b>3TY6483-0A..</b>			
8	3TC52				<b>3TY6523-0A..</b>			
12	3TC56				<b>3TY6566-0A..</b>			
<b>Contacts with fixing parts</b>								
	In order to ensure reliable operation of the contactors, only <b>original spare contacts</b> should be used.							
2	3TC44	(1 set = 2 moving and 4 fixed contacts)			<b>3TY2440-0A</b>		1 1 unit 41B	
4	3TC48				<b>3TY2480-0A</b>		1 1 unit 41B	
8	3TC52				<b>3TY2520-0A</b>		1 1 unit 41B	
12	3TC56				<b>3TY2560-0A</b>		1 1 unit 41B	
12	3TC7	Main contacts (1 set) For 3TC78: 2 units required per contactor			<b>3TY2740-0E</b>		1 1 unit 41B	
<b>Arc chutes</b>								
	2	3TC44	Arc chutes, 2-pole			<b>3TY2442-0A</b>		1 1 unit 41B
	4	3TC48				<b>3TY2482-0A</b>		1 1 unit 41B
	8	3TC52				<b>3TY2522-0A</b>		1 1 unit 41B
	12	3TC56				<b>3TY2562-0A</b>		1 1 unit 41B
	12	3TC7	For 3TC78: 2 units required per contactor			<b>3TY2742-0C</b>		1 1 unit 41B

<sup>1)</sup> Rated control supply voltages, see page 4/79. The 10th and 11th digits of the article number must be supplemented accordingly.

## Switching devices – Contactors and contactor assemblies – Special applications

### Notes