

Monitoring and control devices



	Price groups PG 41B, 41E, 41F, 41H, 41L, 42F, 42J, 42K		<u>SIRIUS 3RR21, 3RR22 monitoring relays for mounting on 3RT2 contactors</u>
10/2	Introduction	10/57	Current and active current monitoring <u>SIRIUS 3RR24 monitoring relays for mounting on 3RT2 contactors for IO-Link</u>
	SIMOCODE 3UF motor management and control devices <u>SIMOCODE M 3UF8 motor management and control devices</u>	10/65	Current and active current monitoring <u>SIRIUS 3UG5 monitoring relays for stand-alone installation</u>
10/5	General data	10/72	General data
10/11	Basic units NEW	10/76	Line monitoring NEW
10/13	Accessories NEW	10/83	Voltage monitoring NEW
	<u>SIMOCODE pro 3UF7 motor management and control devices</u>	10/87	Current monitoring NEW
10/15	General data	10/90	Current, active current, voltage, power factor, and power monitoring NEW
10/22	Basic units		Residual current monitoring
10/25	Expansion modules	10/97	- Residual current monitoring relays NEW
10/27	Fail-safe expansion modules	10/101	- 3UL23 residual-current transformers
10/28	Accessories	10/102	Level monitoring NEW
	Software	10/106	Speed monitoring NEW
14/13	<u>SIMOCODE ES (TIA Portal) NEW</u>	10/110	Accessories
14/17	<u>SIMOCODE pro block library for SIMATIC PCS 7</u>		<u>SIRIUS 3UG45, 3UG46 monitoring relays for stand-alone installation</u>
	<u>3UF18 current transformers for overload protection</u>	10/111	Insulation monitoring <u>SIRIUS 3RS2 temperature monitoring relays</u>
10/31	Basic units and accessories	10/116	General data
10/32	LOGO! logic modules	10/124	Basic units
	Relays <u>Timing relays</u>	10/125	Accessories <u>SIRIUS 3RN2 thermistor motor protection</u>
10/33	General data	10/126	General data
10/34	SIRIUS 3RP25 timing relays, 17.5 mm and 22.5 mm	10/133	Basic units
10/46	SIRIUS 3RP20 timing relays, 45 mm	10/134	Accessories <u>Coupling relays and signal converters</u>
10/52	7PV15 timing relays, 17.5 mm	5/1	Coupling relays
3/94	SIRIUS 3RA28 solid-state time-delay auxiliary switches for mounting on 3RT2 contactors and 3RH2 contactor relays	3/131	3TG10 power relays/miniature contactors
3/98	SIRIUS 3RA28 function modules for mounting on 3RT2 contactors and 3RH2 contactor relays	10/135	SIRIUS 3RS70 signal converters

Note:

Products with our Siemens EcoTech label are marked in the catalog with this symbol:







See www.siemens.com/sirius/SiemensEcoTech

Monitoring and control devices

Introduction



Overview

Type	 SIMOCODE M-CP	 SIMOCODE pro C	 SIMOCODE pro V PROFINET General Performance	 SIMOCODE pro S General Performance	 SIMOCODE pro V High Performance PROFIBUS/PROFINET Modbus RTU/EtherNet/IP
SIMOCODE 3UF motor management and control devices					
Basic units	✓	✓	✓	✓	✓
Current measuring modules	--	✓	✓	✓	✓
Current/voltage measuring modules	✓	--	--	--	✓
Operator panels	--	✓	✓	✓	✓
Operator panels with display	✓	--	--	--	✓
Expansion modules	✓	--	✓	✓	✓
Fail-safe expansion modules	--	--	--	--	✓
Current transformers	✓	✓	✓	✓	✓
3UL23 residual-current transformers	✓	--	✓	✓	✓
SIMOCODE ES (TIA Portal)	✓ ¹⁾	✓	✓	✓	✓
SIMOCODE pro block library for SIMATIC PCS 7	--	✓	✓	✓	✓
Page	10/5	10/15	10/15	10/15	10/15

¹⁾ With SIMOCODE ES (TIA Portal) V20.

✓ Corresponds to or available

-- Does not correspond to or not available

Type	 3RP25	 3RP20	 7PV15
Timing relays			
Enclosures			
• 17.5 mm industry and household equipment installation	✓	--	✓
• 22.5 mm industry	✓	--	--
• 45 mm industry	--	✓	--
Monofunction	✓	✓	✓
Multifunction	✓	✓	✓
Combination voltage	✓	✓	✓
Wide voltage range	✓	✓	✓
Application			
• Control systems and mechanical engineering	✓	✓	✓
• Infrastructure	--	--	✓
Device versions with protective coating on printed circuit board	✓	--	--
Page	10/34	10/46	10/52

✓ Corresponds to or available

-- Does not correspond to or not available



Type	3UG551, 3UG561, 3UG571, 3UG581	3UG552, 3UG553	3RR21, 3RR22, 3UG5522	3UG564, 3UG574, 3UG584	3UG5625, 3UG5825 with 3UL23	3UG5501	3UG565, 3UG585	3UG546	3UG458	Page
Monitoring relays										
Line monitoring	✓	--	--	--	--	--	--	--	--	10/76
Voltage monitoring	--	✓	--	✓	--	--	--	--	--	10/83, 10/90
Current monitoring	--	--	✓	✓	--	--	--	--	--	10/57, 10/65, 10/87, 10/90
Active current monitoring	--	--	3RR22 ✓	✓	--	--	--	--	--	10/57, 10/65, 10/90
Power factor monitoring	--	--	--	✓	--	--	--	--	--	10/90
Power monitoring	--	--	--	✓	--	--	--	--	--	10/90
Residual current monitoring	--	--	--	--	✓	--	--	--	--	10/97
Level monitoring	--	--	--	--	--	✓	--	--	--	10/102
Speed monitoring	--	--	--	--	--	--	✓	--	--	10/106
Insulation monitoring	--	--	--	--	--	--	--	--	✓	10/111

✓ Available

-- Not available



Type	3RS2	3RN2	3RS70	Page
Temperature monitoring relays				
Temperature monitoring	✓	--	--	10/116
Thermistor motor protection				
Thermistor motor protection	--	✓	--	10/126
Signal converters				
Single-range converters	--	--	✓	10/135
Multi-range converters	--	--	✓	10/135
Universal converters	--	--	✓	10/135

✓ Available

-- Not available

Monitoring and control devices

Introduction

Connection methods

The monitoring and control devices are available with screw or spring-loaded terminals (push-in).

SIRIUS 3RP20 timing relays and SIRIUS 3RR2 monitoring relays are available with screw terminals or spring-loaded terminals.



Screw terminals



Spring-loaded terminals, spring-loaded terminals (push-in)

The connection method is indicated in the corresponding tables by the symbols shown on orange backgrounds.

"Increased safety" type of protection EEx e/EEEx d according to ATEX Directive 2014/34/EU

The communication-capable, modularly designed SIMOCODE MC-P and SIMOCODE pro motor management systems (SIRIUS Motor Management and Control Devices) protect motors with types of protection EEx e and EEEx d in hazardous areas.

The SIRIUS 3RN2 thermistor motor protection relay protects motors with types of protection EEx e and EEEx d in hazardous areas.

ATEX approval for operation in hazardous areas

The SIRIUS motor management systems SIMOCODE MC-P and SIMOCODE pro 3UF7 are certified for the protection of motors in hazardous areas in accordance with

- ATEX Ex I (M2); equipment group I, category M2 (mining)
- ATEX Ex II (2) GD; equipment group II, category 2 in area GD

The SIRIUS 3RN2011, 3RN2012-...30, 3RN2013 and 3RN2023 thermistor motor protection relays for PTC sensors are certified according to ATEX Ex II (2) G and D for environments with explosive gas or dust loads.

Ordering notes for multi-unit packaging

SIMOCODE pro S, SIRIUS 3RP25 timing relays, SIRIUS 3UG5 monitoring relays, SIRIUS 3RS2 temperature monitoring relays and SIRIUS 3RN2 thermistor motor protection can also be ordered in practical and environmentally friendly multi-unit packaging on request.

Multi-unit packaging with order code X90

When ordering products in multi-unit packaging, the article number of the product concerned must be supplemented with **"-Z"** and, in addition, the order code **"X90"** must be specified.

Ordering examples:

- 3RP2505-1AB30-Z X90;
Order quantity 16 items → Packed number of items 16
- 3RP2505-1BB30-Z X90;
Order quantity 12 items → Packed number of items 12

For more information, [see page 16/7](#).

Overview



SIMOCODE M-CP

More information

Homepage, see www.siemens.com/sirius-simocode
 SiePortal, see www.siemens.com/product_catalog_siep?3UF8
 Simulation tool SIRIUS Sim SIMOCODE M-CP 3UF8, see <https://support.industry.siemens.com/cs/ww/en/view/109763750>
 TIA Selection Tool Cloud (TST Cloud), see www.siemens.com/tstcloud/?node=SimocodeMCP

SIMOCODE M-CP is a flexible, compact motor management system for motors with constant speeds in the low-voltage performance range. It optimizes the connection between I&C and motor feeder, increases plant availability and allows significant savings to be made for installation, commissioning, operation and preventive maintenance of a system.

SIMOCODE M-CP offers, for example:

- Multifunctional, electronic full motor protection that is independent of the automation system
- Integrated voltage and power measurement instead of hardware for the motor control
- Detailed operating, service and diagnostics data
- Open, Ethernet-based communication via PROFINET IO. The devices are set by default to PROFINET IO communication as the fieldbus protocol and can be switched over to EtherNet/IP or Modbus TCP using the SIMOCODE ES software.
- Safety-related function for shutting down motors via a 1-channel input that complies with SIL 1 according to IEC 61508

SIMOCODE ES (TIA Portal) is the software package for SIMOCODE M-CP parameterization, startup and diagnostics. The necessary SIMOCODE ES version V20 is available, see [page 14/13](#).

SIRIUS Sim SIMOCODE M-CP 3UF8



SIRIUS Sim SIMOCODE M-CP: Demo view and logic view

With the SIRIUS Sim simulation tool, you can now also test functions and configurations of SIMOCODE M-CP from SIMOCODE ES in the office. These configurations can then be loaded directly from SIMOCODE ES into real devices.

SIRIUS Sim is available as a free download, see [page 14/27 onwards](#).

Device series

Compact performance with SIMOCODE M-CP

The compact and powerful system specially for use in switchgear of withdrawable design (motor control centers or MCCs for short). With its compact design and the new flexible Single Pair Ethernet (SPE) connection technology for Ethernet communication, the device series provides the optimum solution for space-saving and time-saving installation.

Per feeder each system always comprises one basic unit and one separate current/voltage measuring module. The two modules are electrically connected with each other through the system interface by a connecting cable. The motor current to be monitored is decisive only for the choice of the current/voltage measuring module. Measurement of the voltage is possible up to 690 V.

Optionally, an operator panel with display can be mounted directly on the basic unit or separately from it. For the latter type of installation, a connecting cable is required, see [page 10/13](#).

The basic unit has five standard inputs (110 to 240 V AC/DC or 24 V DC, depending on the voltage version of the basic unit) and four relay outputs and a further 24 V DC input that can be used either as a standard input or with an optional license as a fail-safe digital input (SIL 1 according to IEC 61508) for safety-related shutdown of the motor.

The basic unit is also provided with an input for thermistor motor protection, which can alternatively be used as an input for connecting a floating contact.

For measuring ground fault currents, a 3UL23 external transformer can be connected, see [page 10/101](#).

Moreover, a 1-wire interface is available to which up to 12 temperature sensors can be connected.

For connecting a Single Pair Ethernet (SPE), each basic unit has a 3-pole push-in terminal.

Monitoring and control devices

SIMOCODE 3UF motor management and control devices

SIMOCODE M 3UF8 motor management and control devices

General data

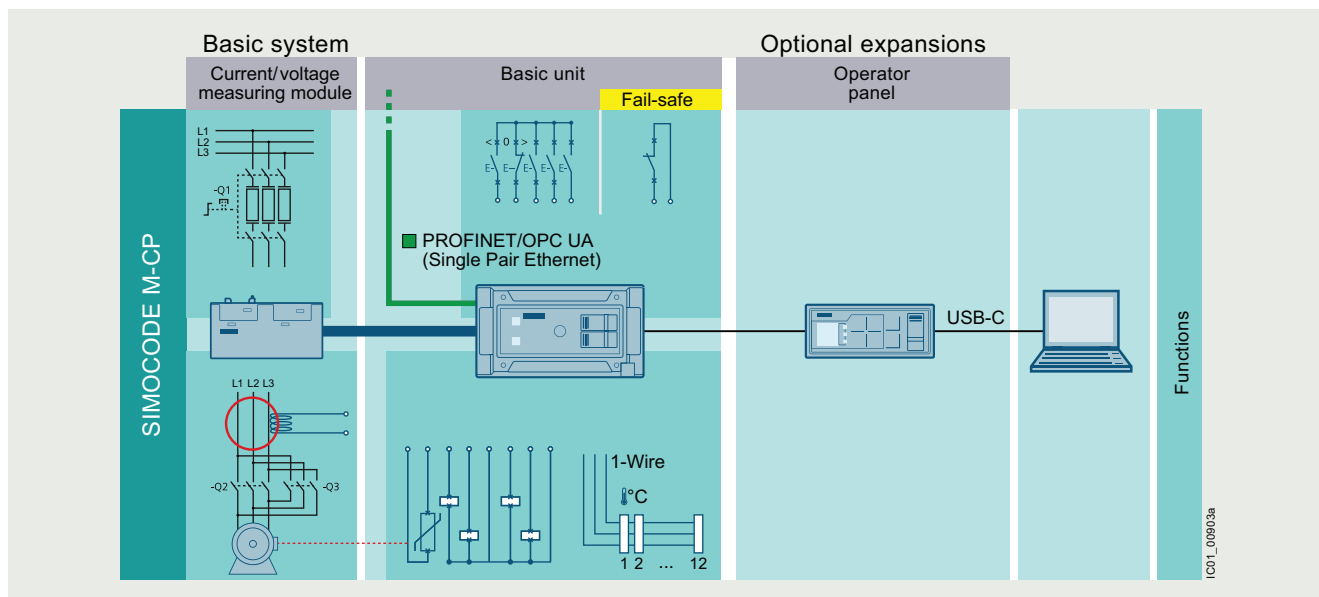

System structure

Article number schemes

SIMOCODE M-CP motor management system

Product versions		Article number
Basic units		3UF8 0 1 <input type="checkbox"/> - 2 A <input type="checkbox"/> 0 0 - 0
Interface hardware	e.g. 1 = PROFINET, EtherNet/IP, Modbus TCP	<input type="checkbox"/>
Voltage version	e.g. B = 24 V DC	<input type="checkbox"/>
Example		3UF8 0 1 1 - 2 A B 0 0 - 0

Product versions		Article number
License for device function		3UF8 8 <input type="checkbox"/> <input type="checkbox"/> - 0 A A 0 0 - 0
Device function	e.g. 10 = condition monitoring with instantaneous value recording	<input type="checkbox"/> <input type="checkbox"/>
Example		3UF8 8 1 0 - 0 A A 0 0 - 0

Product versions		Article number
Current/voltage measuring modules		3UF8 1 1 <input type="checkbox"/> - 1 A <input type="checkbox"/> 0 0 - 0
Current range	e.g. 0 = 0.3 to 40 A	0
Type of construction	e.g. A = straight-through transformer	<input type="checkbox"/>
Example		3UF8 1 1 0 - 1 A A 0 0 - 0

Note:

The article number schemes show an overview of product versions for better understanding of the logic behind the article numbers.

For your orders, please use the article numbers quoted in the selection and ordering data.

Benefits

General customer benefits

- The SIMOCODE M-CP system provides motor management optimized for use in switchboards and withdrawable switching devices.
- Integrating the entire motor feeder into the process control via PROFINET IO, Modbus TCP, EtherNet/IP or OPC UA reduces cabling between the motor feeder and the PLC.
- Using Single Pair Ethernet (SPE) also substantially simplifies the wiring of the communications interface inside the motor control center (MCC).
- Decentralization of the automated processes by means of configurable control and monitoring functions in the feeder saves resources in the automation system and ensures full functionality and protection of the feeder even if the I&C or bus system fails.
- The acquisition and monitoring of operating, service and diagnostics data in the feeder and process control system increases plant availability as well as preventive maintenance and service-friendliness of the feeder.
- The replacement of the control circuit hardware with integrated control functions decreases the number of hardware components and wiring required and in this way limits stock-keeping costs and potential wiring errors.
- The use of electronic full motor protection permits better utilization of the motors and ensures long-term stability of the tripping characteristic and reliable tripping even after years of service.
- The precision of the current, voltage, power and energy measurements for each individual motor feeder enables detailed assignment to the plant components.

Multifunctional, electronic full motor protection for rated motor currents up to 820 A

SIMOCODE M-CP offers comprehensive protection of the motor feeder by combining various multi-step and delayable protection and monitoring functions:

- Inverse-time delayed electronic overload protection (Class 5E to 40E)
- Thermistor motor protection
- Phase failure/asymmetry protection/negative-sequence system protection
- Stall protection on motor starting and during running operation
- Monitoring of adjustable limit values for the motor current
- Voltage and power monitoring
- Power factor monitoring (motor idling/load shedding)
- Ground fault monitoring, also with additional residual-current transformer, [see page 10/101](#).
- Temperature measurement of up to 12 measuring points via 1-wire temperature sensors
- Monitoring of operating hours, downtime, starting time, number of starts, etc.

Recording measured values (rms values)

SIMOCODE M-CP is capable of recording the rms values of, for example, current and voltage and can thus visualize the progression of motor current during motor startup.

Recording instantaneous values for current and voltage

In addition to recording rms values, SIMOCODE M-CP can also record the instantaneous values for current and voltage. This device function can be activated using an optional license key and is then available without further effort.

Flexible motor control implemented with integrated control functions (instead of comprehensive hardware interlocks)

Many predefined motor control functions have already been integrated into SIMOCODE M-CP, including all necessary logic operations and interlocks:

- Overload relays
- Direct-on-line and reversing starters
- Star-delta (wye-delta) starters (also with direction reversal)
- Two speeds, motors with separate windings (pole-changing starter)
- Two speeds, motors with separate Dahlander windings
- Positioner actuation
- Valve control
- Actuation of a motor starter protector
- Soft starter actuation (also with direction reversal)

These control functions are predefined in SIMOCODE M-CP and can be freely assigned to the inputs and outputs of the device (including the data exchanged via the fieldbus interface).

These predefined control functions can also be flexibly adapted to each customized configuration of a motor feeder by means of freely configurable logic modules (truth tables, counters, timers, edge evaluation, etc.) and with the help of standard functions (power failure monitoring, EMERGENCY START, external faults, etc.), without additional auxiliary relays being necessary in the control circuit.

SIMOCODE M-CP eliminates the need for a lot of additional hardware and wiring in the control circuit, which results in a high level of standardization of the motor feeder in terms of its design and circuit diagrams.

Monitoring and control devices

SIMOCODE 3UF motor management and control devices

SIMOCODE M 3UF8 motor management and control devices

General data

Detailed operating, service and diagnostics data

SIMOCODE M-CP makes different operating, service and diagnostics data available and helps to detect potential faults at an early stage and to avert them by means of preventive measures. In the event of a malfunction, a fault can be diagnosed, localized and rectified very quickly – there are no or very short downtimes.

Operating data

- Motor switching state derived from the current flow in the main circuit
- All phase currents
- All phase voltages and phase-to-phase voltages
- Active power, apparent power and power factor
- Phase asymmetry and phase sequence
- Ground fault current
- Frequency
- Time to trip
- Motor temperature (thermistor)
- Remaining cooling time etc.

Service data

- Motor operating hours
- Motor stop times
- Number of motor starts
- Number of overload trips
- Motor load diagram
- Energy consumed
- Error statistics

Diagnostics data

- Numerous detailed early warning and fault messages
- Internal device fault logging with time stamp

Easy operation and diagnostics

Operator panels with display

For SIMOCODE M-CP, an operator panel with a multi-colored illuminated LC graphic display is available. The color of the lighting indicates faults (red) or warnings (yellow). The display is also used for individual labeling of the freely configurable buttons and LEDs, e.g. for controlling the motor and for status display.

Moreover, diagnostics information, measured values, and statistical data can be displayed, along with a unique QR code that can be used to access the function "Web server-based operator control and monitoring via mobile devices".

A USB-C interface on the front is used to for parameter assignment, commissioning, and diagnostics via a PC/PG.

Communication via Single Pair Ethernet (SPE)

SIMOCODE M-CP has a Single Pair Ethernet (SPE) communications interface based on 10Base-T1L (IEEE 802.3cg).

Single Pair Ethernet substantially simplifies the wiring of the communications interface in motor control centers (MCCs). Whereas conventional Industrial Ethernet requires 100Base-TX cables with two twisted-pair cores and RJ45 plug, SPE 10Base-T1L manages with only one pair of wires and no special bus connector and is therefore ideal for bus wiring in MCCs in withdrawable and plug-in design.

Thanks to the robust physical characteristics of the SPE bus, shared use of existing plug-in connections for control signals and bus communication is possible. The bus cable is connected to SIMOCODE M-CP via a removable, 3-pole terminal.

Integration of devices with SPE in Industrial Ethernet with 100Base-TX is achieved using SPE switches.

SIMOCODE M-CP supports leading Ethernet-based fieldbus communications via PROFINET, EtherNet/IP or Modbus TCP and also OPC UA and web server. The devices can be delivered preset to PROFINET communication and can be switched over to the alternative EtherNet/IP or Modbus TCP by parameter assignment, meaning that only one device version is required.

SIMOCODE M-CP PROFINET

SIMOCODE M-CP PROFINET supports, among other things:

- Cyclic data exchange with configurable I/O structure
- Acyclic communication via data records
- Operating, service and diagnostics data via standard web browser
- OPC UA server for open communication with visualization and I&C systems and for online functions with the SIMOCODE ES software
- NTP-synchronized time
- Measured values for energy management using PROFlenergy
- Extensive diagnostics and maintenance alarms

System redundancy with SIMOCODE M-CP PROFINET

All SIMOCODE M-CP PROFINET devices support the system redundancy mechanisms of PROFINET IO and therefore can be operated directly on fault-tolerant systems, such as SIMATIC S7-400H or SIMATIC S7-1500R/H. As such, SIMOCODE M-CP can provide decisive added value also for the field level of plants in which plant availability and control system redundancy are priorities.

SIMOCODE M-CP Modbus TCP

SIMOCODE M-CP Modbus TCP supports, among other things:

- Access to freely configurable process image via Modbus TCP
- Access to all operating, service, and diagnostics data via Modbus TCP
- Operating, service and diagnostics data via standard web browser
- OPC UA server for open communication with visualization and I&C systems and for online functions with the SIMOCODE ES software
- NTP-synchronized time

SIMOCODE M-CP EtherNet/IP

SIMOCODE M-CP EtherNet/IP supports, among other things:

- Operating, service and diagnostics data via standard web browser
- NTP-synchronized time
- OPC UA server for open communication with visualization and I&C systems and for online functions with the SIMOCODE ES software

Notes on security

In order to protect plants, systems, machines and networks against cyber threats, it is necessary to implement – and continuously maintain – a holistic, state-of-the-art industrial cybersecurity concept. Siemens products and solutions represent one component of such a concept.

For more information on industrial cybersecurity, see www.siemens.com/cybersecurity-industry.

Autonomous operation

An essential feature of SIMOCODE M-CP is the autonomous execution of all protection and control functions, even when communication to the I&C system is interrupted. This means that even in the event of bus system or automation system failure, full functionality of the feeder is ensured or a specific behavior can be parameterized in case of such a fault, e.g. targeted shutdown of the feeder or execution of particular parameterized control mechanisms (such as reversal of the direction of rotation).

Advantages from integrated energy management



As an integrated option for the TIA Portal, the SIMATIC Energy Suite couples energy management with automation efficiently, making energy consumption at your production facility transparent.

Thanks to the simplified configuration of energy-measuring components, e.g. SIMOCODE M-CP, configuration effort is also clearly reduced.

Thanks to end-to-end connection with higher-level energy management systems or cloud-based services, you can seamlessly expand the recorded energy data to create a cross-site energy management system.

The advantages at a glance:

- Automatic generation of energy management data
- Integration into TIA Portal and into automation
- Simple configuration

For more information, see page 1/3 or www.siemens.com/energysuite.

Application

SIMOCODE M-CP is often used for automated processes where plant downtimes are very expensive (e.g. chemical, oil/gas, water/wastewater, steel or cement industries) and where it is important to prevent plant downtimes through detailed operating, service and diagnostics data or to localize faults very quickly when they occur.

SIMOCODE M-CP is compact and space-saving and suited especially for operation in motor control centers (MCCs) in the process industry and for power plant technology.

- Protection and control of motors in hazardous areas for types of protection EEx e/EEx d according to ATEX Directive 2014/34/EU
 - With heavy starting (paper, cement, metal and water industries)
 - In high-availability plants (chemical, oil, raw material processing industries, power plants)
- Dry-running protection of centrifugal pumps based on active power monitoring for type of protection Ex b

Dry-running protection of centrifugal pumps with SIMOCODE M-CP in hazardous areas

SIMOCODE M-CP offers a subsequently loadable function for dry-running protection of centrifugal pumps through active power monitoring and motor switch-off. This applies to centrifugal pumps with progressive flow characteristics, which are also suitable for pumping flammable media and are also installed in hazardous areas. If the active power, and thus the flow rate, falls below a minimum value, the motor – and thus the centrifugal pump – is switched off. When determining the limit values to be monitored, the user is supported by a menu-guided teach-in process in the engineering software.

Monitoring and control devices

SIMOCODE 3UF motor management and control devices

SIMOCODE M 3UF8 motor management and control devices

General data

Technical specifications

More information

Technical specifications, see
<https://support.industry.siemens.com/cs/ww/en/ps/29619/td>
 Equipment Manual SIMOCODE M-CP, see
<https://support.industry.siemens.com/cs/ww/en/view/109973290>

Digital Configuration Manual for load feeders, see
<https://imp.siemens.com/digital-engineering-manual/dem>
 Configuration Manual for load feeders, see
<https://support.industry.siemens.com/cs/ww/en/view/39714188>

More information

Protective separation

All circuits in SIMOCODE M-CP are safely isolated from each other according to IEC 60947-1. This means that they are designed with double clearances and creepage distances. In the event of a fault, therefore, no parasitic voltages can be formed in neighboring circuits.

Types of protection EEx d and EEx e

The overload protection and the thermistor motor protection of the SIMOCODE M-CP system comply with the requirements for overload protection of explosion-proof motors of the type of protection:

- EEx d "Flameproof enclosure", e.g. according to IEC 60079-1
- EEx e "Increased safety", e.g. according to IEC 60079-7

When using SIMOCODE M-CP devices with a 24 V DC control voltage, electrical separation must be ensured using a battery or a safety transformer according to IEC 61558-2-6.

Type of protection Ex b

The function for dry-running protection of centrifugal pumps in hazardous areas complies with the requirements of the following type of protection:

- Ex b "Control of ignition source", ignition protection system b1, e.g. according to EN 80079-37

SIMOCODE M-CP is registered for the dry-running protection of centrifugal pumps by means of active power monitoring according to both ATEX and IEC Ex.

Selection and ordering data

Version	Spring-loaded terminals (push-in)		PU (UNIT, SET, M)	PS*	PG
Article No.	Price per PU				

SIMOCODE M-CP NEW



3UF8011-2AB00-0



3UF8011-2AU00-0

SIMOCODE M-CP

Single Pair Ethernet 10BASE-T1L IEEE 802.3cg
PROFINET IO, EtherNet/IP, Modbus TCP,
1 x bus connection via 3-pole terminal,
6 I/Q freely configurable,
input for thermistor connection,
input for 3UL23 residual-current transformer
for measuring ground faults

Rated control supply voltage U_s :

- 24 V DC
- 110 ... 240 V AC/DC

3UF8011-2AB00-0

1 1 unit 42J

3UF8011-2AU00-0

1 1 unit 42J

Note:

For corresponding residual-current transformers,
see page 10/101.

Version	Article No.	Price per PU	PU (UNIT, SET, M)	PS*	PG
---------	-------------	--------------	-------------------------	-----	----

SIMOCODE M-CP license keys NEW

License keys for enabling function

- Condition monitoring instantaneous value recording for current and voltage¹⁾
- Dry-running protection of centrifugal pumps in the hazardous area according to SIL 1 according to IEC 61508
- Web server-based operator control and monitoring via mobile devices¹⁾
- 1-wire sensor input for temperature sensor and memory module
- 1-channel input for safety-related shutdown according to SIL 1 according to IEC 61508

3UF8810-0AA00-0

1 1 unit 42J

3UF8820-0AA00-0

1 1 unit 42J

3UF8830-0AA00-0

1 1 unit 42J

3UF8840-0AA00-0

1 1 unit 42J

3UF8841-0AA00-0

1 1 unit 42J

¹⁾ Expected to be available from April 2026.

Monitoring and control devices

SIMOCODE 3UF motor management and control devices

SIMOCODE M 3UF8 motor management and control devices



Basic units

Version	Current setting	Screw terminals	⊕	PU (UNIT, SET, M)	PS*	PG
	A	Article No.	Price per PU			

SIMOCODE M-CP current/voltage measuring modules

Current/voltage measuring modules

Voltage measuring up to 690 V, measured values with increased accuracy, power, power factor and frequency monitoring

- Straight-through transformers 0.3 ... 40



3UF8110-1AA00-0



3UF8111-1AA00-0



3UF8112-1AA00-0

1) Version 3UF8112-1AA00-0 can optionally also be used for busbar connection to contactors. For this purpose, mounting kit 3UF8950-0AA00-0 and, depending on the contactor size, terminal parts kit 3UF8951-0AA00-0 (size S6) or 3RT1966-4PA00 (sizes S10/S12) are additionally required, see page 10/14.

3UF8110-1AA00-0	1	1 unit	42J
3UF8111-1AA00-0	1	1 unit	42J
3UF8112-1AA00-0	1	1 unit	42J

Version	Article No.	Price per PU	PU (UNIT, SET, M)	PS*	PG
---------	-------------	-----------------	-------------------------	-----	----

SIMOCODE M-CP operator panels with display

Operator panel

Installation on the front of the device or front panel mounting, graphical display with colored backlight, three LEDs for status display, four freely assignable buttons, USB-C interface







3UF8200-1AA00-0

3UF8200-1AA00-0	1	1 unit	42J
-----------------	---	--------	-----

Note:

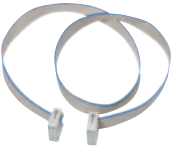
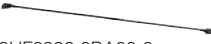
If the operator panel is used separately from the basic unit, a mounting adapter 3UF8922-0.A00-0 and a connecting cable 3UF893-0BA00-0 are required.

Selection and ordering data







Version	Article No.	Price per PU	PU (UNIT, SET, M)	PS*	PG
Accessories for motor control centers					
With the withdrawable design frequently used in motor control centers, it is possible to integrate a SIMOCODE initialization module in the switchboard on a permanent basis. Feeder-related parameter and address data can then be permanently assigned to this feeder.					
 3UF8902-0AA00-0	Initialization module NEW For automatic parameter assignment of SIMOCODE M-CP basic units	3UF8902-0AA00-0	1	1 unit	42J
Y connecting cables					
For use in conjunction with the initialization module; connects the basic unit, current/voltage measuring module and initialization module					
System interface length		Open cable end			
0.5 m		1.0 m	3UF7932-0CA00-0	1	1 unit 42J
1.0 m		1.0 m	3UF7937-0CA00-0	1	1 unit 42J
Connecting cables (essential accessories)					
In different lengths for connecting basic unit and current/voltage measuring module					
Version		Length			
 3UF7932-0AA00-0		Flat	0.3 m	3UF7935-0AA00-0	1 1 unit 42J
			0.5 m	3UF7932-0AA00-0	1 1 unit 42J
		Round	0.5 m	3UF7932-0BA00-0	1 1 unit 42J
			1.0 m	3UF7937-0BA00-0	1 1 unit 42J
			2.5 m	3UF7933-0BA00-0	1 1 unit 42J
Connecting cables, optional					
Connecting cables for operator panel					
 3UF8932-0BA00-0	For connecting the operator panel to the basic unit when mounted separately				
	• Length 0.5 m	3UF8932-0BA00-0	1	1 unit	42J
	• Length 1 m	3UF8937-0BA00-0	1	1 unit	42J
PC cables					
USB PC cable					
 8WD4618-0FB	USB-C plug to USB-A plug, for connecting a PC to SIMOCODE M-CP, length 2 m, black	8WD4618-0FB	1	1 unit	42K
Mounting adapters					
Mounting adapters					
• For operator panel when mounted separately					
- Width 95 mm, height 58 mm					
- Width 105 mm, height 42 mm					
• For mounting on the base unit for attachment to DIN rail					
 3UF8922-0AA00-0		3UF8922-0AA00-0	1	1 unit	42J
 3UF8922-0BA00-0		3UF8922-0BA00-0	1	1 unit	42J
		3UF8910-0AA00-0	1	1 unit	42J
DIN-rail adapters					
DIN-rail adapters					
• For basic unit 3UF8011-2A.00-0: Two DIN-rail adapters are required.					
• For current/voltage measuring modules 3UF811.-1AA00-0: One DIN-rail adapter is required for each.					
 3UF8920-0AA00-0		3UF8920-0AA00-0	1	2 units	42J

Monitoring and control devices

SIMOCODE 3UF motor management and control devices

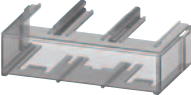
SIMOCODE M 3UF8 motor management and control devices

Accessories

Version	Article No.	Price per PU	PU (UNIT, SET, M)	PS*	PG
Seals					
 <p>Seals For base unit and operator panel when mounted in front panel to achieve degree of protection IP54</p> <p>3UF8923-0AA00-0</p>	3UF8923-0AA00-0		1 10 units		42J
Terminal covers					
 <p>Cover for cable lugs and busbar connections • Length 120 mm, can be used for 3UF8112-1AA00-0</p> <p>3RT1966-4EA1</p>	3RT1966-4EA1		1 1 unit		41B
 <p>Cover for screw terminals Between contactor and current measuring module or current/voltage measuring module for direct mounting • Can be used for 3UF8112-1AA00-0</p> <p>3RT1966-4EA3</p>	3RT1966-4EA3		1 1 unit		41B
Mounting and connection kits					
 <p>Mounting kit For bar connection of the current/voltage measuring module 3UF8112-1AA00-0 to SIRIUS contactors, sizes S6 to S12 <u>Note:</u> A terminal parts kit for a contactor, depending on the contactor size, is additionally required.</p> <p>3UF8950-0AA00-0</p>	3UF8950-0AA00-0		1 1 unit		42J
 <p>Terminal parts kits for one complete contactor Each set includes six screws, spring washers and nuts. • Size S6, M 10 x 30/M 8 x 25 • Sizes S10, S12, M 10 x 30</p> <p>3RT1966-4PA00</p>	3UF8951-0AA00-0		1 1 unit		42J
	3RT1966-4PA00		1 1 unit		41B
Software					
 <p>SIMOCODE ES (TIA Portal) NEW Software for configuring, commissioning, operating and diagnosing SIMOCODE M-CP based on the TIA Portal, see page 14/13.</p> <p>3ZS1322...</p>					
	SIRIUS Sim SIMOCODE M-CP 3UF8 NEW Available free of charge as a download for simulating configurations, see page 14/27 onwards				

Overview

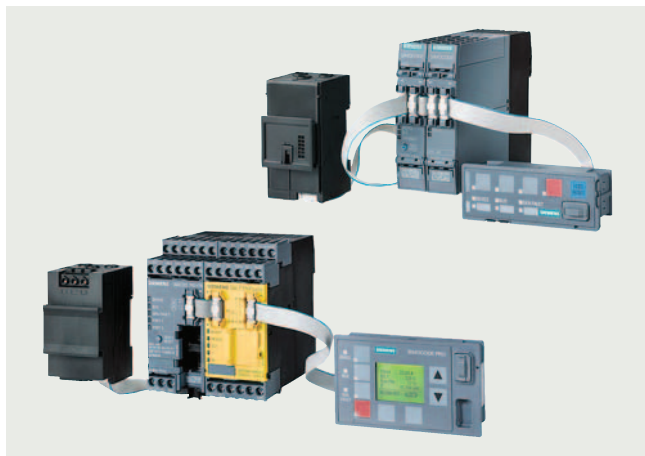

SIMOCODE pro S and SIMOCODE pro V

More information

- Homepage, see www.siemens.com/sirius-simocode
- SiePortal, see www.siemens.com/product_catalog_siep?3UF7
- TIA Selection Tool Cloud (TST Cloud)
 - For SIMOCODE pro S, see www.siemens.com/tstcloud/?node=SimocodeProS
 - For SIMOCODE pro V, see www.siemens.com/tstcloud/?node=SimocodeProV
 - Topic page, see <https://support.industry.siemens.com/cs/ww/en/view/109803120>

SIMOCODE pro is a flexible, modular motor management system for motors with constant speeds in the low-voltage performance range. It optimizes the connection between I&C and motor feeder, increases plant availability and allows significant savings to be made for installation, commissioning, operation and preventive maintenance of a system.

SIMOCODE pro offers, for example:

- Multifunctional, electronic full motor protection that is independent of the automation system
- Integrated control functions instead of hardware for the motor control
- Detailed operating, service and diagnostics data
- Open communication via PROFIBUS DP, PROFINET/OPC UA, Modbus RTU or EtherNet/IP
- Safety relay function for the fail-safe disconnection of motors up to SIL 3 according to IEC 61508, IEC 62061 or PL e according to ISO 13849-1
- Device versions with protective coating on printed circuit board
- SIMOCODE ES is the software package for SIMOCODE pro parameterization, startup and diagnostics, see page 14/13.

Device series

Basic Performance with SIMOCODE pro C







The compact system for direct-on-line and reversing starters or for controlling a motor starter protector.

General Performance with SIMOCODE pro S or SIMOCODE pro V PN GP

The smart system for direct-on-line, reversing, and star-delta (wye-delta) starters or for controlling a motor starter protector or soft starter. Its expandability with an expansion module/multifunction module provides comprehensive input/output project data volume, precise ground fault detection via the 3UL23 residual-current transformers and temperature measurement.

High Performance with SIMOCODE pro V

The variable system with all control functions and with the possibility of expanding the inputs, outputs and functions of the system at will using expansion modules.

	PROFINET IO/OPC UA	ETHERNET/IP	PROFIBUS	MODBUS RTU	
Current/voltage measuring module	 SIMOCODE pro V PN	 SIMOCODE pro V EIP	 SIMOCODE pro V PB	 SIMOCODE pro V MR	High Performance
Operator panel with display					
Max. 5/7 expansion modules					
Safety					
Extended control functions (e.g. slide valve, pole-changing starter)					
Current measuring module	 SIMOCODE pro V PN GP		 SIMOCODE pro S		General Performance
Operator panel					
1 expansion module					
Basic control functions (e.g. direct-on-line/reversing start)					

Device series

Monitoring and control devices

SIMOCODE 3UF motor management and control devices

SIMOCODE pro 3UF7 motor management and control devices

General data

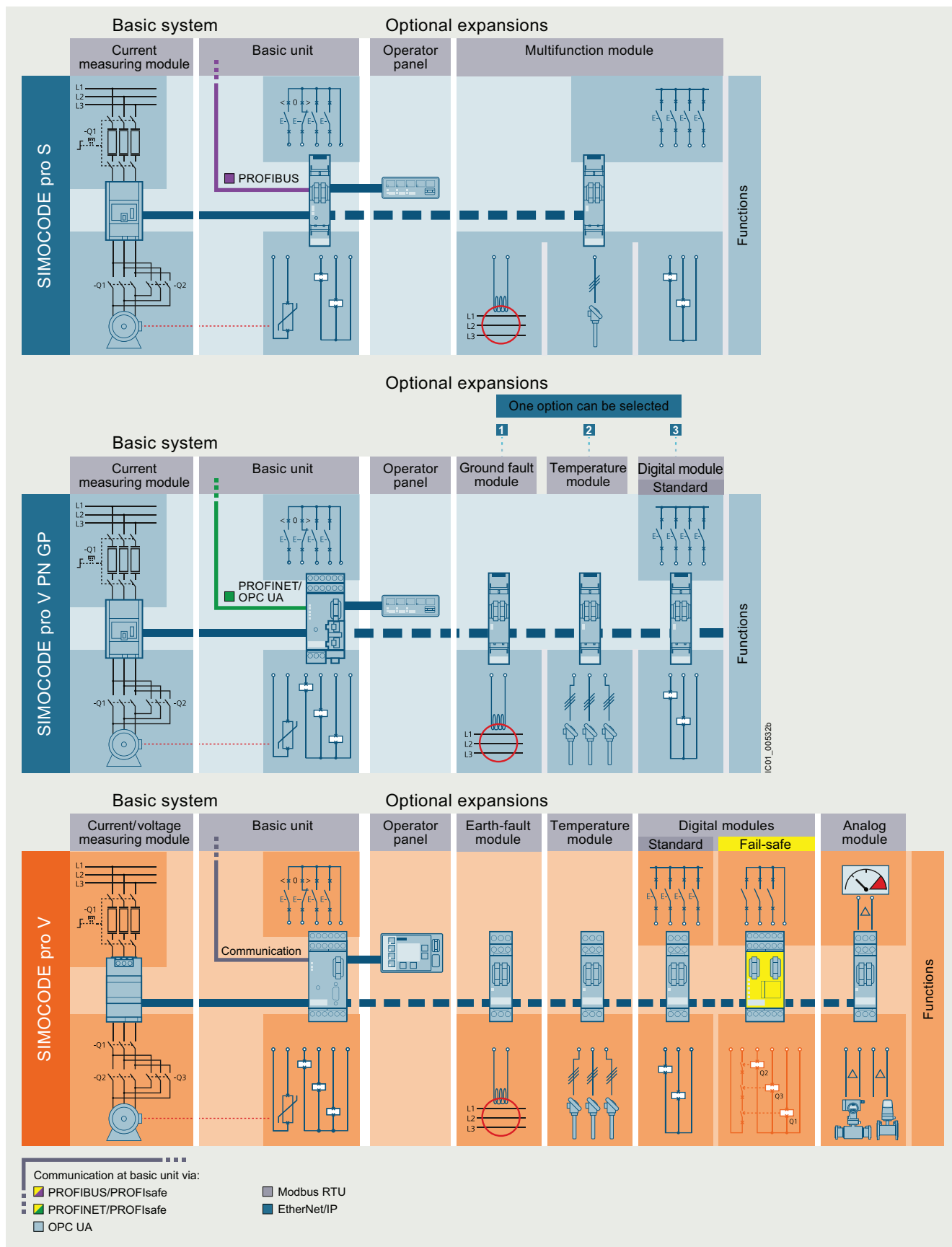

System structure

Expansion possibilities	SIMOCODE pro C	SIMOCODE pro S	SIMOCODE pro V	SIMOCODE pro V	
	Basic Performance PROFIBUS	General Performance PROFIBUS	General Performance PROFINET GP	High Performance PROFIBUS/ Modbus RTU	PROFINET/ EtherNet/IP
Operator panels	✓	✓	✓	✓	✓
Operator panels with display	--	--	--	✓	✓
Current measuring modules	✓	✓	✓	✓	✓
Current/voltage measuring modules	--	--	--	✓	✓
Expansion modules:					
• Digital modules	--	--	1 ²⁾	2	2
• Fail-safe digital modules ¹⁾	--	--	--	1	1
• Analog modules	--	--	--	1	2
• Ground fault modules	--	--	1	1	1
• Temperature modules	--	--	1	1	2
• Multifunction modules	--	1 ³⁾	--	--	--

✓ Available

-- Not available

1) The fail-safe digital module can be used instead of one of the two digital modules.

2) Only monostable version can be used.

3) A monostable digital module, a ground fault module or a temperature module with a temperature sensor can be used instead of the multifunction module.

Per feeder each system always comprises one basic unit and one separate current measuring module. The two modules are connected together electrically through the system interface with a connecting cable and can be mounted mechanically connected as a unit (one behind the other) or separately (side by side). The motor current to be monitored is decisive only for the choice of the current measuring module.

An operator panel for mounting in the control cabinet door is optionally connectable through a second system interface on the basic unit. Both the current measuring module and the operator panel are electrically supplied by the basic unit through the connecting cable. More inputs, outputs and functions can be

added to the SIMOCODE pro V and SIMOCODE pro S by means of optional expansion modules, thus supplementing the inputs and outputs already existing on the basic unit. With the DM-F Local and DM-F PROFIsafe fail-safe digital modules it is also possible to integrate the fail-safe disconnection of motors in the SIMOCODE pro V motor management system.

All modules are connected by connecting cables. The connecting cables are available in various lengths. The maximum distance between the modules (e.g. between the basic unit and the current measuring module) must not exceed 2.5 m. The total length of all the connecting cables per system interface of the basic unit may be up to 3 m.

Article number scheme

Product versions		Article number												
SIMOCODE pro motor management system		3UF7	<input type="checkbox"/>	<input type="checkbox"/>	<input type="checkbox"/>	<input type="checkbox"/>	- 1	<input type="checkbox"/>	<input type="checkbox"/>	<input type="checkbox"/>	<input type="checkbox"/>	<input type="checkbox"/>	<input type="checkbox"/>	<input type="checkbox"/>
Type of unit/module	e.g. 0 = basic unit		<input type="checkbox"/>											
Functional version of the module	e.g. 20 = SIMOCODE pro S		<input type="checkbox"/>	<input type="checkbox"/>										
Connection type of the current transformer	e.g. A = through-hole technology					<input type="checkbox"/>								
Voltage version	e.g. B = 24 V DC						<input type="checkbox"/>							
Enclosure color	e.g. 1 = titanium gray								<input type="checkbox"/>					
Versions	With protective coating on printed circuit board												0 A X 0	
Example		3UF7	0	2	0	- 1	A	B	0	1	-	0	A	X 0

Note:

The article number scheme shows an overview of product versions for better understanding of the logic behind the article numbers.

For your orders, please use the article numbers quoted in the selection and ordering data.

Monitoring and control devices

SIMOCODE 3UF motor management and control devices

SIMOCODE pro 3UF7 motor management and control devices

General data

Benefits

General customer benefits

- Integrating the whole motor feeder into the process control by means of PROFIBUS DP, PROFINET/OPC UA, Modbus RTU or EtherNet/IP significantly reduces the wiring between the motor feeder and the PLC.
- Decentralization of the automated processes by means of configurable control and monitoring functions in the feeder saves resources in the automation system and ensures full functionality and protection of the feeder even if the I&C or bus system fails.
- The acquisition and monitoring of operating, service and diagnostics data in the feeder and process control system increases plant availability as well as preventive maintenance and service-friendliness of the feeder.
- The high degree of modularity allows users to perfectly implement their plant-specific requirements for each motor feeder.
- The SIMOCODE pro system offers functionally graded and space-saving solutions for each customer application.
- The replacement of the control circuit hardware with integrated control functions decreases the number of hardware components and wiring required and in this way limits stock-keeping costs and potential wiring errors.
- The use of electronic full motor protection permits better utilization of the motors and ensures long-term stability of the tripping characteristic and reliable tripping even after years of service.
- Thanks to the precision of the current, voltage, power and energy measurements (especially those acquired by the 2nd-generation current/voltage measuring modules), costs can be internally allocated with a high degree of accuracy.
- Device versions with protective coating on printed circuit board

Multifunctional, electronic full motor protection for rated motor currents up to 820 A

SIMOCODE pro offers comprehensive protection of the motor feeder by means of a combination of different, multi-step and delayable protection and monitoring functions:

- Inverse-time delayed electronic overload protection (Class 5E to 40E)
- Thermistor motor protection
- Phase failure/asymmetry protection
- Stall protection
- Monitoring of adjustable limit values for the motor current
- Voltage and power monitoring
- Power factor monitoring (motor idling/load shedding)
- Ground fault monitoring
- Temperature monitoring, e.g. via Pt100/Pt1000
- Monitoring of operating hours, downtime and number of starts, etc.

Recording of measurement curves

SIMOCODE pro can record measurement curves and therefore is able, for example, to present the progression of motor current during motor startup.

Flexible motor control implemented with integrated control functions (instead of comprehensive hardware interlocks)

Many predefined motor control functions have already been integrated into SIMOCODE pro, including all necessary logic operations and interlocks:

- Overload relays
- Direct-on-line and reversing starters
- Star-delta (wye-delta) starters (also with direction reversal)
- Two speeds, motors with separate windings (pole-changing starter); also with direction reversal
- Two speeds, motors with separate Dahlander windings (also with direction reversal)
- Slide valve actuation
- Valve control
- Actuation of a motor starter protector
- Soft starter actuation (also with direction reversal)

These control functions are predefined in SIMOCODE pro and can be freely assigned to the inputs and outputs of the device (including the PROFIBUS/PROFINET process image).

These predefined control functions can also be flexibly adapted to each customized configuration of a motor feeder by means of freely configurable logic modules (truth tables, counters, timers, edge evaluation, etc.) and with the help of standard functions (power failure monitoring, emergency start, external faults, etc.), without additional auxiliary relays being necessary in the control circuit.

SIMOCODE pro makes a lot of additional hardware and wiring in the control circuit unnecessary, which results in a high level of standardization of the motor feeder in terms of its design and circuit diagrams.

Detailed operating, service and diagnostics data

SIMOCODE pro makes different operating, service and diagnostics data available and helps to detect potential faults at an early stage and to avert them by means of preventive measures. In the event of a malfunction, a fault can be diagnosed, localized and rectified very quickly – there are no or very short downtimes.

Operating data

- Motor switching state derived from the current flow in the main circuit
- All phase currents
- All phase voltages and phase-to-phase voltages
- Active power, apparent power and power factor
- Phase asymmetry and phase sequence
- Ground fault current
- Frequency
- Time to trip
- Motor temperature
- Remaining cooling time etc.

Service data

- Motor operating hours
- Motor stop times
- Number of motor starts
- Number of overload trips
- Interval for compulsory testing of the enabling circuits
- Energy consumed
- Internal comments stored in the device etc.

Diagnostics data

- Numerous detailed early warning and fault messages
- Internal device fault logging with time stamp
- Time stamping of freely selectable status, alarm or fault messages etc.

Easy operation and diagnosticsOperator panel

The 3UF720 operator panel is used to control the motor feeder and can replace all conventional pushbuttons and indicator lights to save space. It makes SIMOCODE pro or the feeder directly operable in the control cabinet. It features all the status LEDs available on the basic unit and externalizes the system interface, e.g. for simple parameterization or diagnostics on a PC/PG.

Operator panel with display

As an alternative to the 3UF720 standard operator panel for SIMOCODE pro V (except for SIMOCODE pro V PN GP), a 3UF721 operator panel with display is also available. This can additionally indicate current measured values, operating and diagnostics data or status information of the motor feeder at the control cabinet. The pushbuttons of the operator panel can be used to control the motor. Furthermore, it is possible to set parameters such as rated motor current, limit values, etc. directly via the operator panel with display (with SIMOCODE pro V PROFIBUS as of E15, SIMOCODE pro V Modbus RTU as of E03, SIMOCODE pro V PROFINET and EtherNet/IP).

Communication

SIMOCODE pro has either an integrated PROFIBUS DP or Modbus RTU interface (SUB-D or terminal connection) or a PROFINET or EtherNet/IP interface (2 x RJ45).

Fail-safe disconnection through PROFIBUS or PROFINET with the PROFIsafe profile is also possible in conjunction with a fail-safe controller (F-CPU) and the DM-F PROFIsafe fail-safe digital module.

SIMOCODE pro PROFIBUS

SIMOCODE pro PROFIBUS supports, for example:

- Cyclic services (DPV0) and acyclic services (DPV1)
- Extensive diagnostics and hardware interrupts
- Time stamp with high timing precision (SIMATIC S7) for SIMOCODE pro V
- DPV1 communication after the Y-Link

SIMOCODE pro PROFINET

SIMOCODE pro PROFINET supports, for example:

- Line and ring bus topology (for 2-port devices with an integrated switch)
- Media redundancy via MRP protocol (for 2-port devices with an integrated switch)
- Operating, service and diagnostics data via standard web browser
- OPC UA server for open communication with visualization and I&C systems
- NTP-synchronized time
- Interval function and measured values for energy management via PROFEnergy
- Module exchange without PC/memory module through proximity detection
- Extensive diagnostics and maintenance alarms

System redundancy with SIMOCODE pro PROFINET

All SIMOCODE PROFINET devices support the system redundancy mechanisms of PROFINET IO and therefore can be operated directly on fault-tolerant systems, such as SIMATIC S7-400H or SIMATIC S7-1500R/H. As such, SIMOCODE pro can provide decisive added value also for the field level of plants in which plant availability and control system redundancy are priorities.

SIMOCODE pro Modbus RTU

SIMOCODE pro Modbus RTU supports, for example:

- Communication at 1 200/2 400/4 800/9 600/19 200 or 57 600 baud
- Access to freely configurable process image via Modbus RTU
- Access to all operating, service and diagnostics data via Modbus RTU

SIMOCODE pro EtherNet/IP

SIMOCODE pro EtherNet/IP supports, for example:

- Line and ring bus topology thanks to an integrated switch
- Ring structures via Device Level Ring (DLR) protocol
- Operating, service and diagnostics data via standard web browser
- NTP-synchronized time
- Parameter assignment via SIMOCODE ES V14 or higher – via local device interface and Ethernet

Monitoring and control devices

SIMOCODE 3UF motor management and control devices

SIMOCODE pro 3UF7 motor management and control devices

General data

Notes on security

In order to protect plants, systems, machines and networks against cyber threats, it is necessary to implement – and continuously maintain – a holistic, state-of-the-art industrial cybersecurity concept. Siemens products and solutions represent one component of such a concept.

For more information on industrial cybersecurity, see www.siemens.com/cybersecurity-industry.

Autonomous operation

An essential feature of SIMOCODE pro is the autonomous execution of all protection and control functions, even when communication to the I&C system is interrupted. This means that even in the event of bus system or automation system failure, full functionality of the feeder is ensured or a specific behavior can be parameterized in case of such a fault, e.g. targeted shutdown of the feeder or execution of particular parameterized control mechanisms (such as reversal of the direction of rotation).

Advantages from integrated energy management

siemens.com/energysuite

Ready for
SIMATIC
Energy Suite

As an integrated option for the TIA Portal, the SIMATIC Energy Suite couples energy management with automation efficiently, making energy consumption at your production facility transparent.

Thanks to the simplified configuration of energy-measuring components, e.g. SIMOCODE pro V, configuration effort is also clearly reduced.

Thanks to end-to-end connection with higher-level energy management systems or cloud-based services, you can seamlessly expand the recorded energy data to create a cross-site energy management system.

The advantages at a glance:

- Automatic generation of energy management data
- Integration into TIA Portal and into automation
- Simple configuration

For more information, see page 1/3 or www.siemens.com/energysuite.

Application

SIMOCODE pro is often used for automated processes where plant downtimes are very expensive (e.g. chemical, oil/gas, water/wastewater, steel or cement industries) and where it is important to prevent plant downtimes through detailed operating, service and diagnostics data or to localize faults very quickly when they occur.

SIMOCODE pro is modular and space-saving and suited especially for operation in motor control centers (MCCs) in the process industry and for power plant technology.

- Protection and control of motors in hazardous areas for types of protection EEx e/EEx d according to ATEX Directive 2014/34/EU
 - With heavy starting (paper, cement, metal and water industries)
 - In high-availability plants (chemical, oil, raw material processing industries, power plants)
- Dry-running protection of centrifugal pumps based on active power monitoring for type of protection Ex b

Suitable for use in harsh ambient conditions

Versions with protective coating on the printed circuit board according to IPC-A-610 are available for use in environments that are exposed to dust, condensation, rapid temperature changes and corrosion. These are intended for applications in rail systems, agriculture, mining, woodworking, etc.

Note:

Other device versions with protective coating on the printed circuit board are available on request.

Safety technology for SIMOCODE pro

The safe disconnection of motors in the process industry is becoming increasingly important as the result of new and revised standards and requirements in the safety technology field.

With the DM-F Local and DM-F PROFIsafe fail-safe expansion modules it is easy to integrate functions for fail-safe disconnection into the SIMOCODE pro V motor management system while retaining service-proven concepts. The strict separation of safety functions and operational functions proves particularly advantageous for planning, configuring and construction. Seamless integration into the motor management system leads to greater transparency for diagnostics and during operation of the system.

Suitable components for this purpose are the DM-F Local and DM-F PROFIsafe fail-safe expansion modules, depending on the requirements:

- The DM-F Local fail-safe digital module for when direct assignment between a fail-safe hardware shutdown signal and a motor feeder is required, or
- The DM-F PROFIsafe fail-safe digital module for when a fail-safe controller (F-CPU) creates the signal for disconnection and transmits it in a fail-safe manner through PROFIBUS/PROFIsafe or PROFINET/PROFIsafe to the motor management system

Dry-running protection of centrifugal pumps with SIMOCODE pro in hazardous areas

Video: Dry-running protection redefined with SIMOCODE pro

With special versions of the current/voltage measuring modules, SIMOCODE pro enables dry-running protection of centrifugal pumps through active power monitoring and motor switch-off. This applies to centrifugal pumps with progressive flow characteristics, which are also suitable for pumping flammable media and are also installed in hazardous areas. If the active power, and thus the flow rate, falls below a minimum value, the motor – and thus the centrifugal pump – is switched off. When determining the limit values to be monitored, the user is supported by a menu-guided teach-in process in the engineering software.

Technical specifications**More information**

Technical specifications, see <https://support.industry.siemens.com/cs/ww/en/ps/16337/td>
SIMOCODE pro – Manual Collection, see <https://support.industry.siemens.com/cs/ww/en/view/109743951>
System Manual for SIMOCODE pro Safety fail-safe digital modules, see <https://support.industry.siemens.com/cs/ww/en/view/50564852>

Digital Configuration Manual for load feeders, see <https://imp.siemens.com/digital-engineering-manual/dem>
Configuration Manual for load feeders, see <https://support.industry.siemens.com/cs/ww/en/view/39714188>

More information**Configuration instructions**

When using an operator panel with display, please note that the type and number of expansion modules that can be connected are limited for the use of a SIMOCODE pro V PROFIBUS basic unit (with product version lower than E15) or SIMOCODE pro V Modbus RTU (with product version lower than E03), see

- [TIA Selection Tool](#)
- [SIMOCODE pro Manual Collection](#)

Protective separation

All circuits in SIMOCODE pro are safely isolated from each other according to IEC 60947-1. This means that they are designed with double clearances and creepage distances. In the event of a fault, therefore, no parasitic voltages can be formed in neighboring circuits. The notes of the test report No. A0258 must be complied with.

Types of protection EEx e and EEx d

The overload protection and the thermistor motor protection of the SIMOCODE pro system comply with the requirements for overload protection of explosion-proof motors of the type of protection:

- EEx d "Flameproof enclosure", e.g. according to IEC 60079-1
- EEx e "Increased safety", e.g. according to IEC 60079-7

When using SIMOCODE pro devices with a 24 V DC control voltage, electrical separation must be ensured using a battery or a safety transformer according to IEC 61558-2-6.
EC type-examination certificate: BVS 06 ATEX F 001
Test report: BVS PP 05.2029 EC.

Type of protection Ex b

The function for dry-running protection of centrifugal pumps in hazardous areas complies with the requirements of the following type of protection:

- Ex b "Control of ignition source", ignition protection system b1, e.g. according to EN 80079-37

SIMOCODE pro is registered for the dry-running protection of centrifugal pumps by means of active power monitoring according to both ATEX and IEC Ex.

Monitoring and control devices





SIMOCODE 3UF motor management and control devices

SIMOCODE pro 3UF7 motor management and control devices

Basic units **IE3/IE4 ready**

Selection and ordering data

Multi-unit packaging for SIMOCODE pro S, see page 16/7.

Version	Screw terminals	PU (UNIT, SET, M)	PS*	PG		
Article No.	Price per PU					
SIMOCODE pro PROFIBUS						
 <p>3UF7000-1AB00-0</p>	SIMOCODE pro C PROFIBUS DP interface, 12 Mbps, RS 485 4 I/3 Q freely configurable, input for thermistor connection, monostable relay outputs Rated control supply voltage U_S : <ul style="list-style-type: none"> • 24 V DC • 110 ... 240 V AC/DC • 110 ... 240 V AC/DC, with protective coating on printed circuit board 	3UF7000-1AB00-0 3UF7000-1AU00-0 3UF7000-1AU00-0AX0	1 1 1	1 unit 1 unit 1 unit	42J 42J 42J	
	 <p>3UF7020-1AU01-0</p>	SIMOCODE pro S PROFIBUS DP interface, 1.5 Mbps, RS 485 4 I/2 Q freely configurable, input for thermistor connection, monostable relay outputs, can be expanded by a multifunction module Note: The connecting cable to the current measuring module must be at least 15 cm. Rated control supply voltage U_S : <ul style="list-style-type: none"> • 24 V DC • 110 ... 240 V AC/DC • 110 ... 240 V AC/DC, with protective coating on printed circuit board 	3UF7020-1AB01-0 3UF7020-1AU01-0 3UF7020-1AU01-0AX0	1 1 1	1 unit 1 unit 1 unit	42J 42J 42J
		 <p>3UF7010-1AB00-0</p>	SIMOCODE pro V PROFIBUS DP interface, 12 Mbps, RS 485 4 I/3 Q freely configurable, input for thermistor connection, monostable relay outputs, can be expanded by expansion modules Rated control supply voltage U_S : <ul style="list-style-type: none"> • 24 V DC • 110 ... 240 V AC/DC • 110 ... 240 V AC/DC, with protective coating on printed circuit board 	3UF7010-1AB00-0 3UF7010-1AU00-0 3UF7010-1AU00-0AX0	1 1 1	1 unit 1 unit 1 unit
SIMOCODE pro PROFINET						
 <p>3UF7011-1AB00-1</p>	SIMOCODE pro V PROFINET GP Ethernet/PROFINET IO, OPC UA server and web server, 100 Mbps, PROFINET system redundancy, 4 I/3 Q freely configurable, input for thermistor connection, monostable relay outputs, can be expanded by expansion module, web server in German/English/Chinese/Russian <u>2 x bus connection via RJ45</u> Media Redundancy Protocol Rated control supply voltage U_S : <ul style="list-style-type: none"> • 24 V DC • 110 ... 240 V AC/DC 		3UF7011-1AB00-1 3UF7011-1AU00-1	1 1	1 unit 1 unit	42J 42J
	 <p>3UF7011-1AB00-0</p>	<u>1 x bus connection via RJ45</u> Rated control supply voltage U_S : <ul style="list-style-type: none"> • 24 V DC • 110 ... 240 V AC/DC 	3UF7011-1AB00-2 3UF7011-1AU00-2	1 1	1 unit 1 unit	42J 42J
		SIMOCODE pro V PROFINET Ethernet/PROFINET IO, OPC UA server and web server, 100 Mbps, 2 x bus connection via RJ45, PROFINET system redundancy, media redundancy protocol, 4 I/3 Q freely configurable, input for thermistor connection, monostable relay outputs, can be expanded by expansion modules, web server in German/English/Chinese/Russian Rated control supply voltage U_S : <ul style="list-style-type: none"> • 24 V DC • 110 ... 240 V AC/DC 	3UF7011-1AB00-0 3UF7011-1AU00-0	1 1	1 unit 1 unit	42J 42J

Version	Current setting	Width	Screw terminals	⊕	PU (UNIT, SET, M)	PS*	PG
	A	mm	Article No.	Price per PU			
SIMOCODE pro Modbus RTU							
	SIMOCODE pro V Modbus RTU Modbus RTU interface, 57.6 Kbps, RS 485, 4 I/3 Q freely configurable, input for thermistor connection, monostable relay outputs, can be expanded by expansion modules Rated control supply voltage U_s : • 24 V DC • 110 ... 240 V AC/DC		3UF7012-1AB00-0 3UF7012-1AU00-0		1 1	1 unit 1 unit	42J 42J
3UF7012-1A.00-0							
SIMOCODE pro EtherNet/IP							
	SIMOCODE pro V EtherNet/IP EtherNet/IP interface, web server, 100 Mbps, 2 x bus connection via RJ45, DLR media redundancy, 4 I/3 Q freely configurable, input for thermistor connection, monostable relay outputs, can be expanded by expansion modules, web server in German/English/Chinese/Russian Rated control supply voltage U_s : • 24 V DC • 110 ... 240 V AC/DC		3UF7013-1AB00-0 3UF7013-1AU00-0		1 1	1 unit 1 unit	42J 42J
3UF7013-1AB00-0							
SIMOCODE pro current or current/voltage measuring modules							
	Current measuring modules • Straight-through transformers 0.3 ... 3 45 2.4 ... 25 45 10 ... 100 55 20 ... 200 120 • Busbar connection ¹⁾ 20 ... 200 120 63 ... 630 145		3UF7100-1AA00-0 3UF7101-1AA00-0 3UF7102-1AA00-0 3UF7103-1AA00-0 3UF7103-1BA00-0 3UF7104-1BA00-0		1 1 1 1 1 1	1 unit 1 unit 1 unit 1 unit 1 unit 1 unit	42J 42J 42J 42J 42J 42J
3UF7103-1AA00-0							
	2nd-generation current/voltage measuring modules for SIMOCODE pro V²⁾ Voltage measuring up to 690 V, measured values with increased accuracy, power, power factor and frequency monitoring • Straight-through transformers 0.3 ... 4 45 3 ... 40 45 10 ... 115 55 20 ... 200 120 • Busbar connection ¹⁾ 20 ... 200 120 63 ... 630 145		3UF7110-1AA01-0 3UF7111-1AA01-0 3UF7112-1AA01-0 3UF7113-1AA01-0 3UF7113-1BA01-0 3UF7114-1BA01-0		1 1 1 1 1 1	1 unit 1 unit 1 unit 1 unit 1 unit 1 unit	42J 42J 42J 42J 42J 42J
3UF7110-1AA01-0							
	Current/voltage measuring modules for dry-running protection of centrifugal pumps in hazardous areas²⁾³⁾⁴⁾ • Straight-through transformers 0.3 ... 4 45 3 ... 40 45 10 ... 115 55 20 ... 200 120 • Busbar connection ¹⁾ 20 ... 200 120 63 ... 630 145		3UF7120-1AA01-0 3UF7121-1AA01-0 3UF7122-1AA01-0 3UF7123-1AA01-0 3UF7123-1BA01-0 3UF7124-1BA01-0		1 1 1 1 1 1	1 unit 1 unit 1 unit 1 unit 1 unit 1 unit	42J 42J 42J 42J 42J 42J
3UF7123-1AA01-0							

¹⁾ One terminal parts kit 3RT1955-4PA00 or 3RT1966-4PA00 (see page 10/30) is included in the scope of supply for connection to a contactor.

²⁾ When installing the basic unit on a current/voltage measuring module, the connecting cable must be at least 15 cm long.

³⁾ The current/voltage measuring modules for dry-running protection require SIMOCODE pro V PROFIBUS basic units as of product version E16, SIMOCODE pro V PROFINET as of product version E13 or SIMOCODE pro V EtherNet/IP as of product version E04.

⁴⁾ When using an operator panel with display with the current/voltage measuring modules for dry-running protection, an operator panel with display as of product version E03 is required.

Note:



Other device versions with protective coating on the printed circuit board are available on request.

Monitoring and control devices

SIMOCODE 3UF motor management and control devices

SIMOCODE pro 3UF7 motor management and control devices

Basic units **IE3/IE4 ready**

Version	Screw terminals 	PU (UNIT, SET, M)	PS*	PG
Article No.	Price per PU			
SIMOCODE pro operator panels				
 <p>3UF7200-1AA01-0</p>	<p>Operator panel</p> <p>Installation in control cabinet door or front plate, for plugging into all SIMOCODE pro basic units, ten LEDs for status indication and freely assignable buttons for controlling the motor, titanium gray</p>	3UF7200-1AA01-0	1	1 unit 42J
Operator panels for SIMOCODE pro V				
 <p>3UF7210-1AA01-0</p>	<p>Installation in control cabinet door or front plate, for plugging into SIMOCODE pro V (except for SIMOCODE pro V PN GP), seven LEDs for status indication and freely assignable buttons for controlling the motor, multilingual display, e.g. for indication of measured values, status information or fault messages, titanium gray</p> <ul style="list-style-type: none"> • English/German/French/Spanish/Portuguese/Italian/Polish/Finnish • English/Chinese/Russian/Korean 	3UF7210-1AA01-0 3UF7210-1BA01-0	1 1	1 unit 42J 1 unit 42J

Selection and ordering data

Version	Screw terminals	PU (UNIT, SET, M)	PS*	PG
	Article No.	Price per PU		

Expansion modules for SIMOCODE pro V

With SIMOCODE pro V, it is possible to expand the type and number of inputs and outputs in steps. Each expansion module has two system interfaces on the front. Through the one system interface the expansion module is connected to the system interface of the SIMOCODE pro V using a connecting cable; through the second system interface, further expansion modules or the operator panel can be connected. The power supply for the expansion modules is provided by the connecting cable through the basic unit.

Note:

The SIMOCODE pro V PN GP basic unit can be used with the 3UF7300-1A.00-0 monostable digital module, the 3UF7510-1AA00-0 ground fault module, or the 3UF7700-1AA0-0 temperature module.

Please order connecting cable separately, [see page 10/13](#).

Digital modules

Up to two digital modules can be used to add additional binary inputs and relay outputs to the basic unit. The input circuits of the digital modules are supplied from an external power supply.

Four binary inputs and two relay outputs, up to two digital modules can be connected

Relay outputs: Input voltage:

- Monostable 24 V DC
110 ... 240 V AC/DC
- Bistable 24 V DC
110 ... 240 V AC/DC,
with protective coating on
printed circuit board

3UF7300-1AB00-0	1	1 unit	42J
3UF7300-1AU00-0	1	1 unit	42J
3UF7300-1AU00-0AX0	1	1 unit	42J
3UF7310-1AB00-0	1	1 unit	42J
3UF7310-1AU00-0	1	1 unit	42J



3UF7300-1AB00-0

Analog module

By means of the analog module, the basic unit can be optionally expanded by analog inputs and outputs (0/4 ... 20 mA).

Two inputs (passive) for input and one output for output of 0/4 ... 20 mA signals, up to one analog module can be connected per pro V PB/MB RTU basic unit and up to two analog modules per pro V PN/EIP basic unit

3UF7400-1AA00-0	1	1 unit	42J
------------------------	---	--------	-----



3UF7400-1AA00-0

Ground fault module

Ground fault monitoring using 3UL23 residual-current transformers and ground fault modules is used in cases where precise detection of the ground fault current is required or power systems with high impedance are grounded.

With the ground fault module, it is possible to determine the precise fault current as a measured value, and to define freely selectable warning and trip limits in a wide range from 30 mA ... 40 A.

One input for connecting a 3UL23 residual-current transformer, up to one ground fault module can be connected

Note:

For corresponding residual-current transformers, [see page 10/101](#).

3UF7510-1AA00-0	1	1 unit	42J
------------------------	---	--------	-----



3UF7510-1AA00-0

Temperature module

Irrespective of the thermistor motor protection of the basic units, up to an additional three analog temperature sensors can be evaluated using a temperature module.

Sensor types: Pt100/Pt1000, KTY83/KTY84 or NTC

Three inputs for connecting up to three analog temperature sensors, up to one temperature module can be connected per pro V PB/MB RTU basic unit and up to two temperature modules per pro V PN/EIP basic unit

3UF7700-1AA00-0	1	1 unit	42J
------------------------	---	--------	-----



3UF7700-1AA00-0

Monitoring and control devices

SIMOCODE 3UF motor management and control devices

SIMOCODE pro 3UF7 motor management and control devices

Expansion modules

Multi-unit packaging,
see page 16/7.

Version	Screw terminals	PU (UNIT, SET, M)	PS*	PG
	Article No.	Price per PU		

Expansion modules for SIMOCODE pro S

With SIMOCODE pro S, it is possible to expand the type and number of inputs and outputs. The expansion module has two system interfaces on the front. Through the one system interface the expansion module is connected to the system interface of the SIMOCODE pro S using a connecting cable; through the second system interface, the operator panel can be connected. The power supply for the expansion module is provided by the connecting cable through the basic unit.

Note:

Please order connecting cable separately, [see page 10/13](#).



3UF7600-1AU01-0

Multifunction modules

The multifunction module is the expansion module of the SIMOCODE pro S device series with the following functions:

- Digital module function with four digital inputs and two monostable relay outputs
- Ground fault module function with an input for the connection of a 3UL23 residual-current transformer with freely selectable warning and trip limits in a wide zone of 30 mA ... 40 A
- Temperature module function with an input for connecting an analog temperature sensor Pt100, Pt1000, KTY83, KTY84, or NTC

Up to one multifunction module can be connected per SIMOCODE pro S basic unit

Input voltage of the digital inputs:

- 24 V DC
- 110 ... 240 V AC/DC

3UF7600-1AB01-0	1	1 unit	42J
3UF7600-1AU01-0	1	1 unit	42J

Selection and ordering data

Version	Screw terminals	PU (UNIT, SET, M)	PS*	PG
	Article No.	Price per PU		

Fail-safe expansion modules for SIMOCODE pro V

Thanks to the fail-safe expansion modules, SIMOCODE pro V can be expanded with the function of a safety relay for the fail-safe disconnection of motors. A maximum of one fail-safe digital module can be connected; it can be used instead of a digital module.

The fail-safe expansion modules are equipped likewise with two system interfaces on the front for making the connection to other system components. Unlike other expansion modules, power is supplied to the modules through a separate terminal connection.

Note:

Please order connecting cable separately, see page 10/13.

DM-F Local fail-safe digital modules

For fail-safe disconnection using a hardware signal
Two relay enabling circuits, joint switching; two relay outputs, common potential disconnected fail-safe; inputs for sensor circuit, start signal, cascading and feedback circuit, safety function adjustable using DIP switches

Rated control supply voltage U_s :

- 24 V DC
- 110 ... 240 V AC/DC

3UF7320-1AB00-0

1 1 unit 42J

3UF7320-1AU00-0

1 1 unit 42J

DM-F PROFIsafe fail-safe digital modules¹⁾

For fail-safe disconnection using PROFIBUS/PROFIsafe or PROFINET/PROFIsafe

Two relay enabling circuits, joint switching; two relay outputs, common potential disconnected fail-safe; one input for feedback circuit; three binary standard inputs

Rated control supply voltage U_s :

- 24 V DC
- 110 ... 240 V AC/DC

3UF7330-1AB00-0

1 1 unit 42J

3UF7330-1AU00-0

1 1 unit 42J



3UF7320-1AB00-0



3UF7330-1AB00-0

¹⁾ Cannot be used in conjunction with SIMOCODE pro V for Modbus RTU or EtherNet/IP communication.





Monitoring and control devices





SIMOCODE 3UF motor management and control devices

SIMOCODE pro 3UF7 motor management and control devices

Accessories

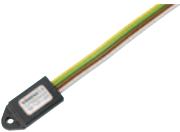
Selection and ordering data

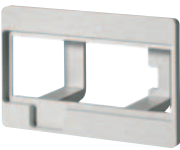
Version	Article No.	Price per PU	PU (UNIT, SET, M)	PS*	PG																																																
Connecting cables (essential accessories)																																																					
 <p>In different lengths for connecting basic unit, current measuring module, current/voltage measuring module, operator panel or expansion modules</p>																																																					
<table border="1"> <thead> <tr> <th>Version</th> <th>Length</th> <th>Article No.</th> <th>PU (UNIT, SET, M)</th> <th>PS*</th> <th>PG</th> </tr> </thead> <tbody> <tr> <td rowspan="5">Flat</td> <td>0.025 m</td> <td>3UF7930-0AA00-0</td> <td>1</td> <td>1 unit</td> <td>42J</td> </tr> <tr> <td>0.1 m</td> <td>3UF7931-0AA00-0</td> <td>1</td> <td>1 unit</td> <td>42J</td> </tr> <tr> <td>0.15 m</td> <td>3UF7934-0AA00-0</td> <td>1</td> <td>1 unit</td> <td>42J</td> </tr> <tr> <td>0.3 m</td> <td>3UF7935-0AA00-0</td> <td>1</td> <td>1 unit</td> <td>42J</td> </tr> <tr> <td>0.5 m</td> <td>3UF7932-0AA00-0</td> <td>1</td> <td>1 unit</td> <td>42J</td> </tr> <tr> <td rowspan="3">Round</td> <td>0.5 m</td> <td>3UF7932-0BA00-0</td> <td>1</td> <td>1 unit</td> <td>42J</td> </tr> <tr> <td>1.0 m</td> <td>3UF7937-0BA00-0</td> <td>1</td> <td>1 unit</td> <td>42J</td> </tr> <tr> <td>2.5 m</td> <td>3UF7933-0BA00-0</td> <td>1</td> <td>1 unit</td> <td>42J</td> </tr> </tbody> </table>						Version	Length	Article No.	PU (UNIT, SET, M)	PS*	PG	Flat	0.025 m	3UF7930-0AA00-0	1	1 unit	42J	0.1 m	3UF7931-0AA00-0	1	1 unit	42J	0.15 m	3UF7934-0AA00-0	1	1 unit	42J	0.3 m	3UF7935-0AA00-0	1	1 unit	42J	0.5 m	3UF7932-0AA00-0	1	1 unit	42J	Round	0.5 m	3UF7932-0BA00-0	1	1 unit	42J	1.0 m	3UF7937-0BA00-0	1	1 unit	42J	2.5 m	3UF7933-0BA00-0	1	1 unit	42J
Version	Length	Article No.	PU (UNIT, SET, M)	PS*	PG																																																
Flat	0.025 m	3UF7930-0AA00-0	1	1 unit	42J																																																
	0.1 m	3UF7931-0AA00-0	1	1 unit	42J																																																
	0.15 m	3UF7934-0AA00-0	1	1 unit	42J																																																
	0.3 m	3UF7935-0AA00-0	1	1 unit	42J																																																
	0.5 m	3UF7932-0AA00-0	1	1 unit	42J																																																
Round	0.5 m	3UF7932-0BA00-0	1	1 unit	42J																																																
	1.0 m	3UF7937-0BA00-0	1	1 unit	42J																																																
	2.5 m	3UF7933-0BA00-0	1	1 unit	42J																																																
PC cables and adapters																																																					
 <p>USB PC cable For connecting to the USB interface of a PC/PG, for communication with SIMOCODE pro through the system interface</p>																																																					
3UF7941-0AA00-0	3UF7941-0AA00-0		1	1 unit	42J																																																
<p>USB/serial adapter For connecting an RS 232 PC cable to the USB interface of a PC</p>																																																					
	3UF7946-0AA00-0		1	1 unit	42J																																																
Memory modules																																																					
 <p>Enable transmission to a new system, e.g. when a device is replaced, without the need for additional aids or detailed knowledge of the device.</p>																																																					
<p>Memory module for SIMOCODE pro C For saving the complete parameterization of a SIMOCODE pro C system, titanium gray</p>																																																					
3UF7901-0AA01-0	3UF7900-0AA01-0		1	1 unit	42J																																																
<p>Memory module for SIMOCODE pro S and pro V For saving the complete parameterization of a SIMOCODE pro system, titanium gray</p>																																																					
	3UF7901-0AA01-0		1	1 unit	42J																																																
Interface covers																																																					
 <p>For system interface, titanium gray</p>																																																					
3RA6936-0B	3RA6936-0B		1	5 units	42F																																																
Addressing plugs																																																					
 <p>For assigning the PROFIBUS or Modbus RTU address without using a PC/PG to SIMOCODE pro through the system interface</p>																																																					
3UF7910-0AA00-0	3UF7910-0AA00-0		1	1 unit	42J																																																





Version	Article No.	Price per PU	PU (UNIT, SET, M)	PS*	PG								
Accessories for motor control centers													
 3UF7902-0AA00-0	With the withdrawable design frequently used in motor control centers, it is possible to integrate a SIMOCODE pro initialization module in the switchboard on a permanent basis. Feeder-related parameter and address data can then be permanently assigned to this feeder.												
	Initialization module	3UF7902-0AA00-0	1	1 unit	42J								
	For automatic parameterization of SIMOCODE pro S and SIMOCODE pro V basic units												
	Y connecting cables												
	For use in conjunction with the initialization module; connects the basic unit, current measuring module or current/voltage measuring module, and initialization module												
	<table border="1"> <thead> <tr> <th>System interface length</th> <th>Open cable end</th> </tr> </thead> <tbody> <tr> <td>0.1 m</td> <td>1.0 m</td> </tr> <tr> <td>0.5 m</td> <td>1.0 m</td> </tr> <tr> <td>1.0 m</td> <td>1.0 m</td> </tr> </tbody> </table>	System interface length	Open cable end	0.1 m	1.0 m	0.5 m	1.0 m	1.0 m	1.0 m				
System interface length	Open cable end												
0.1 m	1.0 m												
0.5 m	1.0 m												
1.0 m	1.0 m												
		3UF7931-0CA00-0	1	1 unit	42J								
		3UF7932-0CA00-0	1	1 unit	42J								
		3UF7937-0CA00-0	1	1 unit	42J								
Bus connection terminals													
 3UF7960-0AA00-0	For shield support and strain relief of the PROFIBUS cable on a SIMOCODE pro S	3UF7960-0AA00-0	1	1 unit	42J								
Door adapters													
 3UF7920-0AA00-0	For external connection of the system interface from a control cabinet, for example	3UF7920-0AA00-0	1	1 unit	42J								
Adapters for operator panel													
 3UF7922-0AA00-0	The adapter enables the smaller 3UF7200 operator panel from SIMOCODE pro to be used in a front panel cutout in which previously, e.g. after a change of system, a larger 3UF52 operator panel from SIMOCODE-DP had been used, degree of protection IP54	3UF7922-0AA00-0	1	1 unit	42J								
Labeling strips													
 3UF7925-0AA02-0	• For pushbuttons of the 3UF720 operator panel	3UF7925-0AA00-0	100	400 units	42J								
	• For pushbuttons of the 3UF721 operator panel with display	3UF7925-0AA01-0	100	600 units	42J								
	• For LEDs of the 3UF720 operator panel	3UF7925-0AA02-0	100	1200 units	42J								
Push-in lugs													
 3RV2928-0B	For screw fixing, e.g. on mounting plate (Two lugs are required per device)												
	• Can be used for 3UF71.0, 3UF71.1 and 3UF71.2	3RV2928-0B	100	10 units	41E								
	• Can be used for 3UF700, 3UF701, 3UF73, 3UF74, 3UF75 and 3UF77	3RP1903	1	10 units	41H								
• Can be used for 3UF7020 and 3UF7600	3ZY1311-0AA00	1	10 units	41L									

Monitoring and control devices

SIMOCODE 3UF motor management and control devices

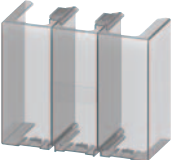
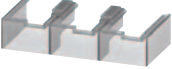
SIMOCODE pro 3UF7 motor management and control devices

Accessories

Version	Article No.	Price per PU	PU (UNIT, SET, M)	PS*	PG	
Terminal covers						
 <p>3RT1956-4EA1</p>  <p>3RT1956-4EA2</p>	Covers for cable lug and busbar connections <ul style="list-style-type: none"> Length 100 mm, can be used for 3UF71.3-1BA0.-0 Length 120 mm, can be used for 3UF71.4-1BA0.-0 	3RT1956-4EA1 3RT1966-4EA1	1	1 unit	41B	
	Covers for box terminals <ul style="list-style-type: none"> Length 25 mm, can be used for 3UF71.3-1BA0.-0 Length 30 mm, can be used for 3UF71.4-1BA0.-0 	3RT1956-4EA2 3RT1966-4EA2	1	1 unit	41B	
	Covers for screw terminals Between contactor and current measuring module or current/voltage measuring module for direct mounting	3RT1956-4EA3 3RT1966-4EA3	1	1 unit	41B	
	<ul style="list-style-type: none"> Can be used for 3UF71.3-1BA0.-0 Can be used for 3UF71.4-1BA0.-0 	3RT1956-4EA3 3RT1966-4EA3	1	1 unit	41B	
	Terminal parts kits					
	Can be used for current or current/voltage measuring modules with DIN-rail connection, complete for one contactor <ul style="list-style-type: none"> M 8 x 25 M 10 x 30 	3RT1955-4PA00 3RT1966-4PA00	1	1 unit	41B	
Box terminal blocks						
 <p>3RT1956-4G</p>	For round and flat ribbon cables <ul style="list-style-type: none"> Up to 70 mm², can be used for 3UF71.3-1BA0.-0 Up to 120 mm², can be used for 3UF71.3-1BA0.-0 Up to 240 mm², can be used for 3UF71.4-1BA0.-0 	3RT1955-4G 3RT1956-4G 3RT1966-4G	1	1 unit	41B	
	Bus termination modules					
	 <p>3UF1900-1KA00</p>	With separate control supply voltage for bus termination following the last unit on the bus line Supply voltage: <ul style="list-style-type: none"> 115/230 V AC 24 V DC 	3UF1900-1KA00 3UF1900-1KB00	1	1 unit	42J
Software						
 <p>3ZS1322...</p>	SIMOCODE ES (TIA Portal) <i>NEW</i> Software for configuring, commissioning, operating and diagnosing SIMOCODE pro based on the TIA Portal, see page 14/13.					
 <p>3ZS1632...</p>	SIMOCODE pro block library for SIMATIC PCS 7 The PCS 7 block library can be used for simple and easy integration of SIMOCODE pro into the SIMATIC PCS 7 process control system, see page 14/17.					

Overview

More information

Homepage, see www.siemens.com/siriusSiePortal, see www.siemens.com/product_catalog_siep?3UF18

The 3UF18 current transformers are protection transformers and are used for actuating overload relays. Protection transformers are designed to ensure proportional current transfer up to a multiple of the primary rated current. The 3UF18 current transformers convert the maximum current of the corresponding operating range into the standard signal of 1 A secondary.

Selection and ordering data

Type of mounting	Operating range	Screw terminals	PU (UNIT, SET, M)	PS*	PG
	A	Article No.	Price per PU		
For mounting on contactors and stand-alone installation					
Screw fixing	205 ... 820	3UF1868-3GA00	1	1 unit	42J



3UF1868

Accessories

For contactor type	Article No.	Price per PU	PU (UNIT, SET, M)	PS*	PG
Terminal covers					
For transformer/contactor combinations and stand-alone installation for 3UF1868-3GA00 transformer	3TX7696-0A		1	1 unit	41B
<u>Note:</u> One cover required per connection side.					

Monitoring and control devices

LOGO! logic modules

Overview



More information

Homepage, see www.siemens.com/LOGO

SiePortal, see www.siemens.com/product_catalog_siep?logo

LOGO!, see Catalog ST 70

- The compact, user-friendly, and low-cost solution for simple control tasks
- Compact, user-friendly, can be used universally without accessories
- All in one: The display and operator panel are integrated
- 43 different functions can be linked at a press of a button or with PC software; up to 400 times in total
- Functions can be changed simply with the press of a button. No complicated rewiring

LOGO! logic modules

LOGO! basic modules with display



The space-saving basic versions

LOGO! basic modules without display



The cost-optimized basic versions

LOGO! expansion modules



Digital and analog inputs/outputs for connection to LOGO!

LOGO! CMK2000 communications modules



For integration of LOGO! 8 in KNX installations

LOGO! CSM unmanaged



For connecting to Industrial Ethernet in line, tree or star topologies

LOGO!Power



The flat power supply for distribution boards

LOGO!Contact switching modules



For switching resistive loads and motors directly

LOGO! TDE



Low-cost operating interface for applications

LOGO! software



The user-friendly software for switching program generation

Application

The LOGO! logic module is the user-friendly, low-cost solution for simple control tasks.

LOGO! is universally applicable, e.g.:

- Building installation and wiring (lighting, shutters, awnings, doors, access control, barriers, ventilation systems, etc.)
- Control cabinet installation
- Machine and device construction (pumps, small presses, compressors, hydraulic lifts, conveyors, etc.)

- Special controls for conservatories and greenhouses
- Signal preprocessing for other controllers

LOGO! Modular logic modules can be expanded easily for each application.

Marine approvals:

American Bureau of Shipping, Bureau Veritas, Det Norske Veritas, Germanischer Lloyd, Lloyd's Register of Shipping, Polski Rejestr Statków, etc.

Overview



7PV15, SIRIUS 3RP25 and SIRIUS 3RP20 timing relays

More information

Homepage, see www.siemens.com/sirius-timing-relaysSiePortal, see www.siemens.com/product_catalog_siep?3RP

Electronic timing relays are used in control, starting, and protective circuits for all switching operations involving time delays.

Their fully developed concept and space-saving, compact design make the SIRIUS 3RP timing relays ideal timer modules for control cabinet, switchgear and control manufacturers in the industry.

With their narrow design, the 7PV15 timing relays are ideal in particular for use in heating, ventilation and air-conditioning systems and in compressors. All 7PV15 timing relays in this enclosure version are suitable for snap-on mounting on TH 35 DIN rails according to IEC 60175. The enclosure complies with DIN 43880.

The SIRIUS 3RA28 function modules enable the assembly of starters and contactor assemblies for direct-on-line and star-delta (wye-delta) starting. They include the key control functions required for the particular feeder, e.g. timing and electrical interlocking function. The function modules that function as timing relays are mounted quickly and simply on SIRIUS contactors – without any great wiring effort.

The SIRIUS 3RA28 solid-state time-delay auxiliary switches which can be mounted on contactors are designed for contactor coil voltages in the range from 24 to 240 V AC/DC (wide voltage range). Auxiliary switches for control and alarm signals are used specially for switching the smallest signals for electronics applications. They are used, for example, for allowing a pump or fan to run on, or for the delayed activation of a gate drive.

Device series

SIRIUS timing relays for DIN-rail mounting

- SIRIUS 3RP25 timing relays, 17.5 mm and 22.5 mm, see page 10/34 onwards
- SIRIUS 3RP20 timing relays, 45 mm, see page 10/46 onwards
- 7PV15 timing relays, 17.5 mm, see page 10/52 onwards

SIRIUS timing relays for mounting on contactors

- SIRIUS 3RA28 solid-state time-delay auxiliary switches for mounting on 3RT2 contactors and 3RH2 contactor relays, see page 3/94
- SIRIUS 3RA28 function modules for mounting on 3RT2 contactors and 3RH2 contactor relays, see page 3/98
- SIRIUS 3RP25 timing relays for mounting on 3RT10 and 3RT14 contactors, see page 10/34 onwards

Benefits

- The right design for every application
- Clear-cut basic range with five basic units in the case of the 7PV15 timing relays, and up to seven basic units in the case of the 3RP timing relays
- Considerable logistical advantages thanks to versions with wide voltage and wide time range
- No tools required for assembly or disassembly on DIN rails
- Cadmium-free relay contacts
- Recyclable, halogen-free enclosure
- Optimum price/performance ratio
- Versions with logical separation
- Low variance: One design for distribution boards and for control cabinets
- Compliance with EMC requirements for buildings
- Environmentally friendly laser inscription instead of printing containing solvents
- Versions as snap-on modules for reducing wiring and saving space in the control cabinet
- Device versions with protective coating on printed circuit board
- Versions with screw terminals or alternatively with spring-loaded terminals

Application

Timing relays with ON-delay

- Interference pulse suppression (gating of interference pulses)
- Gradual startup of motors so as not to overload the power supply

Timing relays with OFF-delay

- Generation of overtravel functions following removal of voltage
- Gradual, delayed shutdown, e.g. of motors or fans, to allow a plant to be shut down selectively

Clock-pulse relay

- Flashing, asymmetrical

Star-delta (wye-delta) timing relays

- Switching over motors from wye to delta with a dead interval of 50 ms to prevent phase-to-phase short circuits

Multifunctional timing relays

- Maximum flexibility, with a device for every application
- Available with relay and semiconductor output
- Versions for railway applications for more exacting requirements (e.g. temperature range, vibration/shock resistance and EMC)

Watchdog function

- Monitoring of cyclic events

Monitoring and control devices

Relays

Timing relays

SIRIUS 3RP25 timing relays, 17.5 mm and 22.5 mm

Overview

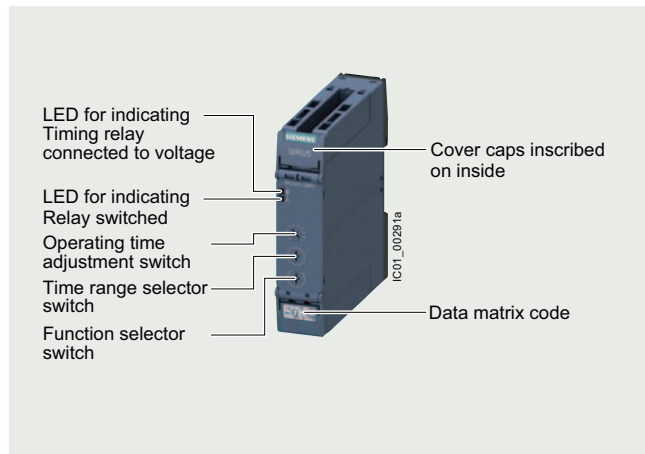

SIRIUS 3RP25 timing relay

More information

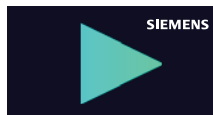
Homepage, see www.siemens.com/sirius-timing-relaysSiePortal, see www.siemens.com/product_catalog_siep?3RP25TIA Selection Tool Cloud (TST Cloud), see www.siemens.com/tstcloud/?node=SIRIUSRelaisConversion tool, see www.siemens.com/conversion-toolSimulator, see <https://support.industry.siemens.com/cs/ww/en/view/103556391>Video: [What are the benefits of SIRIUS 3RP25 timing relays?](#)

Electronic timing relays for general use in control systems and mechanical engineering with:

- 1 or 2 CO, 1 NO (semiconductor) or 3 NO
- Monofunction or multifunction
- Combination voltage or wide voltage range
- Single or selectable time ranges
- Switch position indication and voltage indication by LED
- Device versions with protective coating on printed circuit board

Article number scheme

Product versions		Article number							
Timing relays		3RP25	□	□	□	□	□	□	□
Product function/ time ranges	Multifunction ON-delay	0 5							7 time ranges 0.05 s ... 100 h
		1 1							1 time range 0.5 ... 10 s
		1 2							1 time range 1 ... 3 s
		1 3							1 time range 5 ... 100 s
		2 5							7 time ranges 0.05 s ... 100 h
		2 7							4 time ranges 0.05 s ... 240 s
	OFF-delay with control signal	3 5							7 time ranges 0.05 s ... 100 h
	OFF-delay without control signal, non-volatile, passing make contact	4 0							7 time ranges 0.05 s ... 600 s
	Clock-pulse relay, flashing, asymmetrical	5 5							7 time ranges 0.05 s ... 100 h
	Star-delta (wye-delta) function with coasting function (idling)	6 0							Star delta (wye-delta) 1 ... 20 s, idling time (coasting time) 600 s
	Star-delta (wye-delta) function	7 4							1 time range 1 ... 20 s
		7 6							1 time range 3 ... 60 s
Connection type	Screw terminals						1		
	Spring-loaded terminals (push-in)						2		
Contacts	1 CO						A		
	2 CO						B		
	Semiconductors (transistor NPN)						C		
	Semiconductors (thyristor), two-wire						E		
	1 NO + 1 NO (SD)						N		
	2 CO force-guided						R		
	3 NO						S		
Control supply voltage	24 V AC/DC						B 3		
	200 ... 240 V/380 ... 440 V AC						M 2		
	400 ... 440 V AC						T 2		
	12 ... 240 V AC/DC or 24 ... 240 V AC/DC (3RP2505-.RW30)						W 3		
Versions	With protective coating on printed circuit board								0 A X 0
Example		3RP25 0 5 - 1 A B 3 0							

Note:

The article number scheme shows an overview of product versions for better understanding of the logic behind the article numbers.

For your orders, please use the article numbers quoted in the selection and ordering data.

3RP2505 multifunctional timing relays**Two setting options for implementing the multifunctions (A-M):**

- ① Determination of 13 functions by the setting A to M, with 1 CO, 1 NO, 2 CO that switch in parallel.
- ② Extended function variance by selecting the time range and determining, whether 2 CO switch in parallel or whether 1 CO switches with delay + 1 CO switches instantaneously (1 CO + 1 CO)

Setting the functions on the device

The functions of the 3RP2505 multifunctional timing relays can be set by means of the function selector switch. Whether both CO contacts are switched in parallel or one CO contact with a delay and one instantaneously and the choice of time range are set by means of the time range selector switch. The exact operating time can be adjusted with the operating time switch.

With a set of foil labels the timing relay can be legibly marked with the functions which can be selected on the timing relay. This is supplied together with the multifunctional timing relay.

The same potential must be applied to terminals A. and B.

Note:

The activation of loads parallel to the start input is permissible when using AC/DC control voltage.

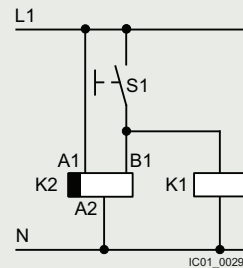

Diagram

Overview of functions

Identification letter	13 functions	27 functions
	1 CO contact (1 CO), 1 NO contact (1 NO) semiconductor, 2 CO contacts switched in parallel (2 CO) or 2 CO contacts force-guided and switched in parallel with delay (2 CO)	13 functions (A - M) 2 CO contacts switched in parallel (2 CO) + 13 functions (A - M) 1 delayed CO contact + 1 instantaneous CO contact (1 CO + 1 CO) and star-delta (wye-delta) function
A	ON-delay	ON-delay and instantaneous contact
B	OFF-delay with control signal	OFF-delay with control signal and instantaneous contact
C	ON-delay/OFF-delay with control signal	ON-delay/OFF-delay with control signal and instantaneous contact
D	Flashing, symmetrical, starting with interval	Flashing, symmetrical, starting with interval and instantaneous contact
E	Passing make contact, interval relay	Passing make contact, interval relay and instantaneous contact
F	Retriggerable interval relay with deactivated control signal (passing break contact with control signal)	Retriggerable interval relay with deactivated control signal (passing break contact with control signal) and instantaneous contact
G	Passing make contact, with control signal, not retriggerable (pulse-forming with control signal)	Passing make contact, with control signal, not retriggerable, (pulse-forming with control signal) and instantaneous contact
H	Additive ON-delay, instantaneous OFF with control signal	Additive ON-delay, instantaneous OFF with control signal and instantaneous contact
I	Additive ON-delay with control signal	Additive ON-delay with control signal and instantaneous contact
J	Flashing, symmetrical, starting with pulse	Flashing, symmetrical, starting with pulse and instantaneous contact
K	Pulse-delayed (fixed pulse (at 1 s) and settable pulse delay)	Pulse-delayed (fixed pulse (at 1 s) and settable pulse delay) and instantaneous contact
L	Pulse-delayed with control signal (fixed pulse (at 1 s) and settable pulse delay)	Pulse-delayed with control signal (fixed pulse (at 1 s) and settable pulse delay) and instantaneous contact
M	Retriggerable interval relay with activated control signal (watchdog)	Retriggerable interval relay with activated control signal and instantaneous contact (watchdog)
--	--	Star-delta (wye-delta) function

Monitoring and control devices

Relays

Timing relays

SIRIUS 3RP25 timing relays, 17.5 mm and 22.5 mm

Simulator

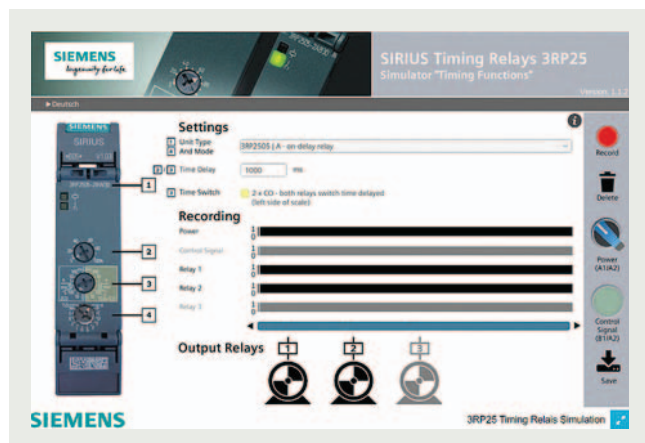

3RP25 simulator

The 3RP25 simulator visualizes different time functions in the 3RP25 timing relay. Any fault scenario can be simulated.

The tool is available free of charge, see <https://support.industry.siemens.com/cs/ww/en/view/103556391>.

Benefits

- Easy stock-keeping and logistics thanks to low variance of devices
- Reduced space requirement in the control cabinet thanks to versions in width 17.5 mm and 22 mm
- Consistent in all functions due to wide voltage range from 12 to 240 V AC/DC
- Up to 27 functions according to IEC 61812 in the multifunctional timing relay with wide voltage range
- Multifunctional timing relay with semiconductor output for high switching frequencies, bounce-free and wear-free switching
- Device versions with protective coating on printed circuit board

Standards and approvals

- IEC 60721-3-3 "Classification of environmental conditions"
- IEC 61812-1/DIN VDE 0435 Part 2021 "Specified time relays for industrial use"
- IEC 61000-6-2, IEC 61000-6-3 and IEC 61000-6-4 "Electromagnetic compatibility"
- IEC 60947-5-1 "Low-voltage switchgear and controlgear – Electromechanical control circuit devices"

Application

Timing relays are used in control, starting, and protective circuits for all switching operations involving time delays. They guarantee a high level of functionality and a high repeat accuracy of timer settings.

Enclosure version

All timing relays are suitable for snap-on mounting on TH 35 DIN rails according to IEC 60715 or for screw fixing.

Suitable for use in harsh ambient conditions

Versions with protective coating on the printed circuit board according to IPC-A-610 are available for use in environments that are exposed to dust, condensation, rapid temperature changes and corrosion. These are intended for applications in rail systems, agriculture, mining, woodworking, etc.

Note:

Other device versions with protective coating on the printed circuit board are available on request.

Technical specifications

More information

Technical specifications, see <https://support.industry.siemens.com/cs/ww/en/ps/16354/td>
Equipment Manual, see <https://support.industry.siemens.com/cs/ww/en/view/103532830>

Internal circuit diagrams, see CAx Download Manager <https://support.industry.siemens.com/my/ww/en/CAxOnline#CAxOnline>
FAQs, see <https://support.industry.siemens.com/cs/ww/en/ps/16354/faq>

Article number	3RP2505-.A, 3RP2505-.C, 3RP251., 3RP2525-.A, 3RP2527, 3RP253., 3RP255.	3RP2505-.B, 3RP2505-.R, 3RP2525-.B, 3RP254., 3RP256., 3RP257.
Width x height x depth	17.5 x 100 x 90	22.5 x 100 x 90

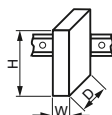



SIRIUS 3RP25 timing relays, 17.5 mm and 22.5 mm

Article number	3RP25...-AB30, 3RP25...-AW30, 3RP25...-BB30, 3RP25...-BW30, 3RP25...-NW30, 3RP25...-RW30 3RP25...-SW30	3RP25...-AW30-0AX0, 3RP25...-BW30-0AX0, 3RP25...-RW30-0AX0	3RP25...-BT20, 3RP25...-NM20	3RP25...-CW30	3RP25...-EW30
----------------	--	--	---------------------------------	---------------	---------------

General technical specifications						
Insulation voltage for overvoltage category III according to IEC 60664 for pollution degree 3, rated value	V	300		500	300	--
Ambient temperature						
• During operation	°C	-25 ... +60				
• During storage	°C	-40 ... +85				
Protective coating on printed circuit board		No	Yes; according to IPC-A-610	No		
Switching capacity current with inductive load	A	0.01 ... 3		0.01 ... 1	0.01 ... 0.6	
Operational current of the auxiliary contacts						
• At AC-15						
- At 24 V	A	3		1	--	
- At 250 V	A	3		1	--	
- At 400 V	A	--		3	--	
• At DC-12						
- At 24 V	A	--		1	--	
- At 125 V	A	--		1	--	
- At 250 V	A	--		1	--	
• At DC-13						
- At 24 V	A	1		--	--	
- At 125 V	A	0.2		--	--	
- At 250 V	A	0.1		--	--	
Thermal current	A	5		1	0.6	
Mechanical endurance (operating cycles), typical		10 000 000				
Electrical endurance (operating cycles) for AC-15 at 230 V typical		100 000		300 000	100 000	

Article number	3RP2505-.AB30, 3RP2505-.BB30, 3RP2525-.BB30, 3RP2540-.AB30, 3RP2540-.AW30, 3RP2540-.BB30, 3RP2540-.BW30	3RP2505-.BT20, 3RP2574-.NM20, 3RP2576-.NM20	3RP2505-.AW30, 3RP2505-.BW30, 3RP2505-.CW30, 3RP2511-.AW30, 3RP2512-.AW30, 3RP2513-.AW30, 3RP2525-.AW30, 3RP2525-.BW30, 3RP2527-.EW30, 3RP2555-.AW30, 3RP2560-.SW30, 3RP2574-.NW30, 3RP2576-.NW30	3RP2535-.AW30	3RP2505-.RW30
----------------	---	---	---	---------------	---------------

General technical specifications					
Operating range factor of the control supply voltage, rated value					
• At AC					
- At 50 Hz		0.85 ... 1.1		0.85 ... 1.1	0.7 ... 1.1
- At 60 Hz		0.85 ... 1.1		0.8 ... 1.1	0.7 ... 1.1
• At DC		0.85 ... 1.1		0.8 ... 1.1	0.7 ... 1.1

Article number	3RP25...-1...0		3RP25...-2...0	
Type of electrical connection for auxiliary and control circuits	 Screw terminals		 Spring-loaded terminals (push-in)	
Design of thread of terminal screw	M3		--	
Tightening torque	Nm	0.6 ... 0.8		--
Type of connectable conductor cross-sections				
• Solid		1 x (0.5 ... 4 mm ²), 2 x (0.5 ... 2.5 mm ²)		1 x (0.5 ... 4 mm ²)
• Finely stranded with end sleeve		1 x (0.5 ... 4 mm ²), 2 x (0.5 ... 1.5 mm ²)		1 x (0.5 ... 2.5 mm ²)
• For AWG cables				
- Solid		1 x (20 ... 12), 2 x (20 ... 14)		1 x (20 ... 12)
- Stranded		1 x (20 ... 12), 2 x (20 ... 14)		1 x (20 ... 12)

Monitoring and control devices

Relays

Timing relays

SIRIUS 3RP25 timing relays, 17.5 mm and 22.5 mm

3RP25 function diagrams

Multifunction 3RP2505-.A, 1 CO, 13 functions and 3RP2505-.C, 1 NO (semiconductor), 13 functions

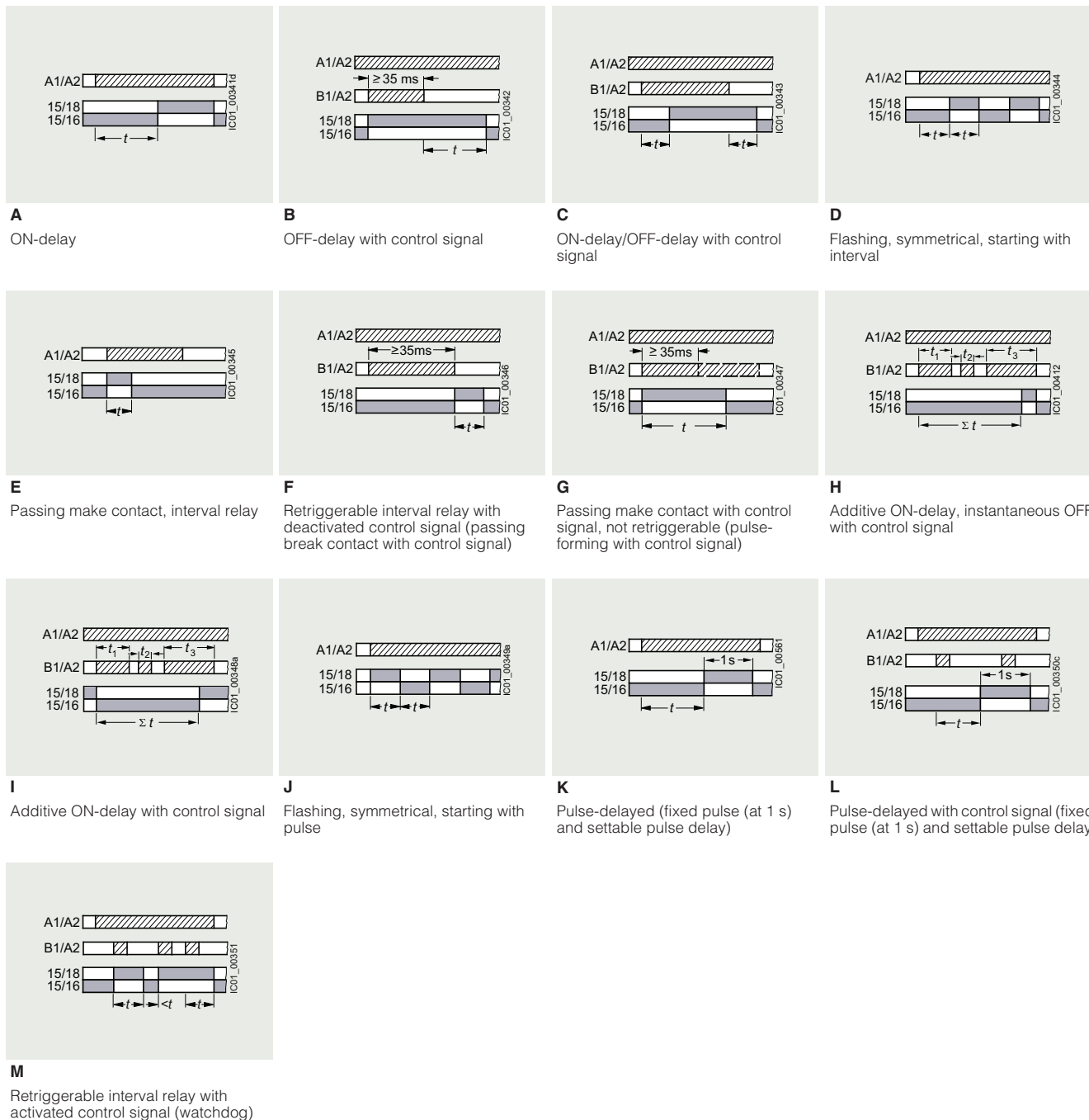

Legend

- A ... M** Identification letters
- Timing relay energized
- Contact closed
- Contact open

SIRIUS 3RP25 timing relays, 17.5 mm and 22.5 mm

Multifunction 3RP2505-.R, 13 functions, 2 CO force-guided and switched in parallel with delay

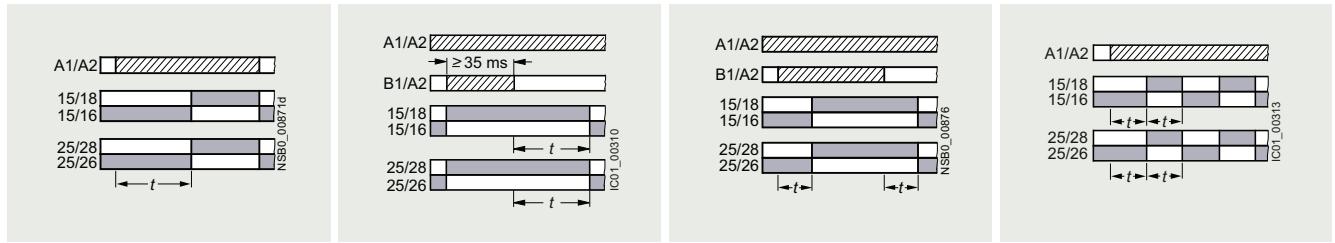

A ON-delay
B OFF-delay with control signal
C ON-delay/OFF-delay with control signal
D Flashing, symmetrical, starting with interval

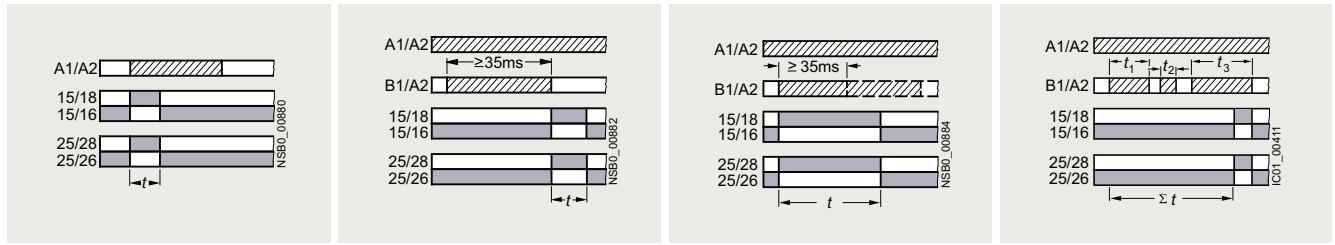

E Passing make contact, interval relay
F Retriggerable interval relay with deactivated control signal (passing break contact with control signal)
G Passing make contact with control signal, not retriggerable (pulse-forming with control signal)
H Additive ON-delay, instantaneous OFF with control signal

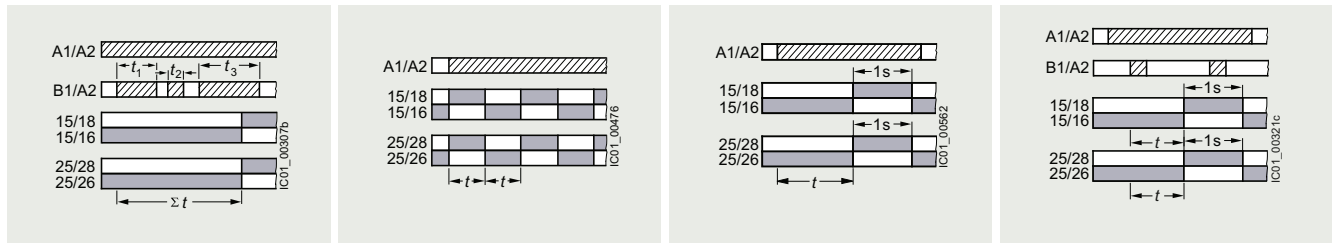

I Additive ON-delay with control signal
J Flashing, symmetrical, starting with pulse
K Pulse-delayed (fixed pulse at 1 s and settable pulse delay)
L Pulse-delayed with control signal (fixed pulse at 1 s and settable pulse delay)

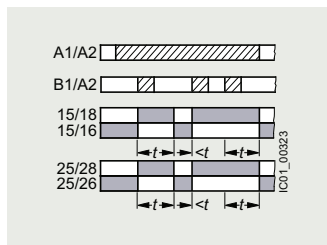

M Retriggerable interval relay with activated control signal (watchdog)

Legend

- A ... M** Identification letters
- Timing relay energized
- Contact closed
- Contact open

Monitoring and control devices

Relays

Timing relays

SIRIUS 3RP25 timing relays, 17.5 mm and 22.5 mm

Multifunction 3RP2505-.B, 27 functions, 2 CO

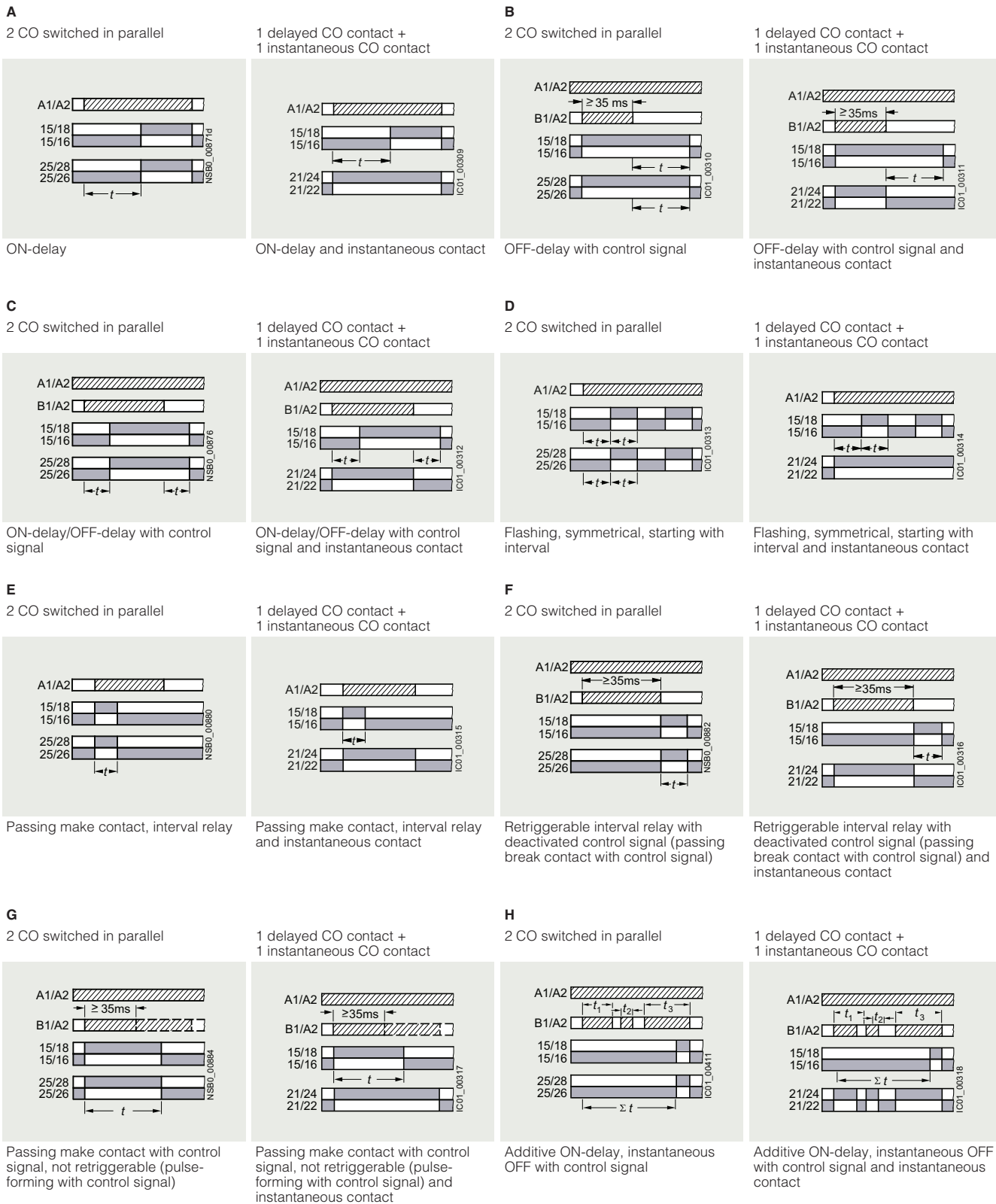

Legend

- A ... H** Identification letters
- Timing relay energized
- Contact closed
- Contact open

Multifunction 3RP2505-B, 27 functions, 2 CO (continued)

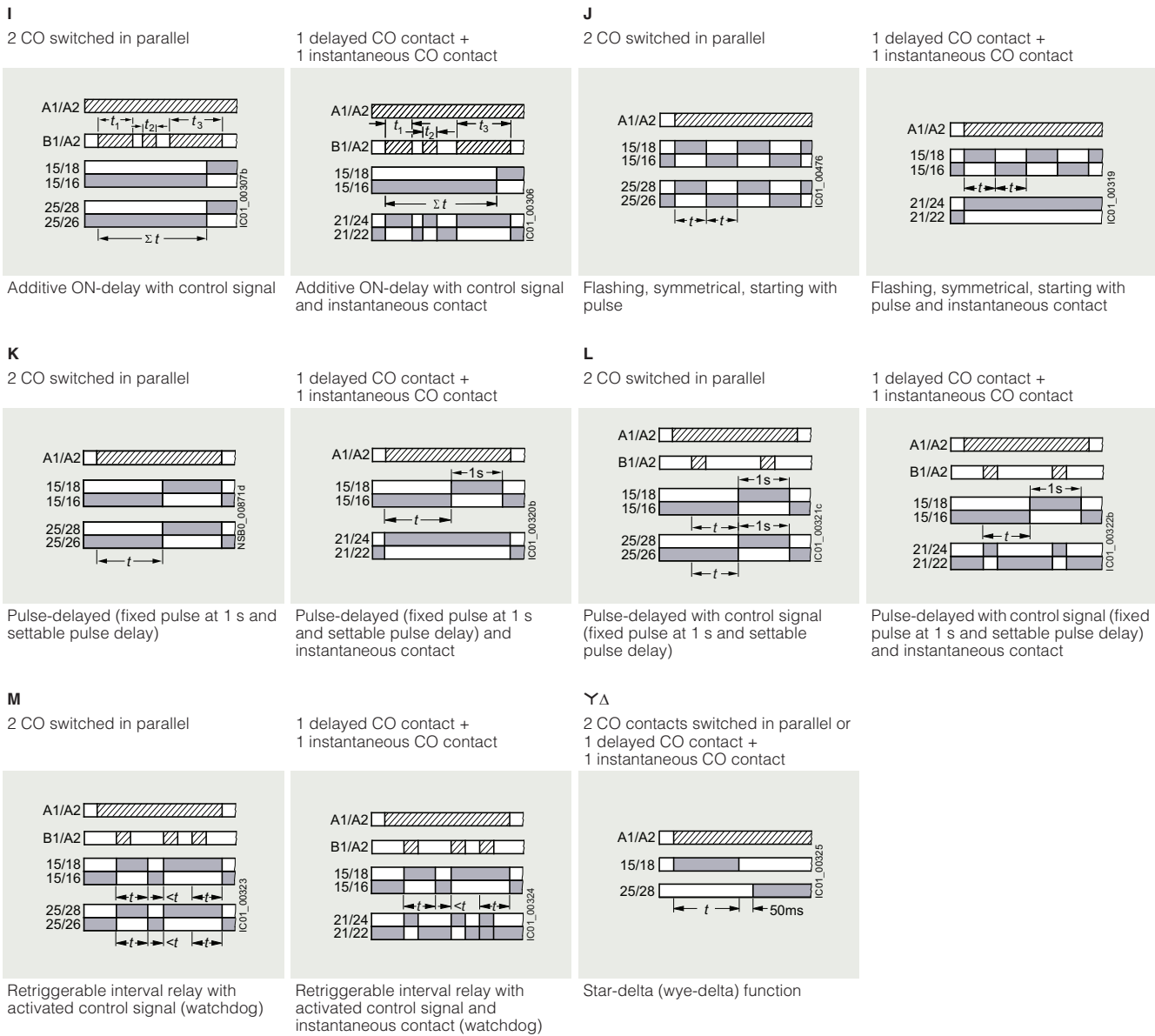

Legend

- I ... M Identification letters
- ▨ Timing relay energized
- Contact closed
- Contact open

Monitoring and control devices

Relays

Timing relays

SIRIUS 3RP25 timing relays, 17.5 mm and 22.5 mm

Monofunctions 3RP251. to 3RP257.¹⁾

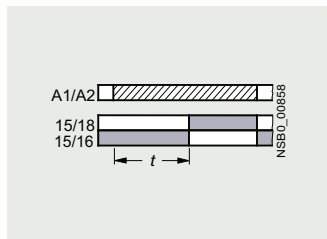

3RP251-.AW30, 1 CO, ON-delay

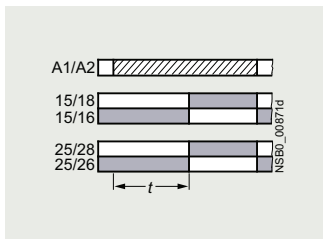

3RP2525-.W30, 2 CO, ON-delay

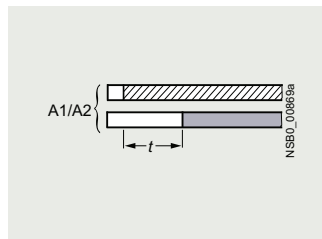

3RP2527-.EW30, 1 NO (semiconductor), ON-delay

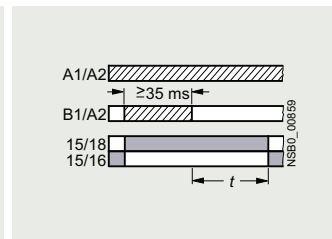

3RP2535-.AW30, 1 CO, OFF-delay with control signal

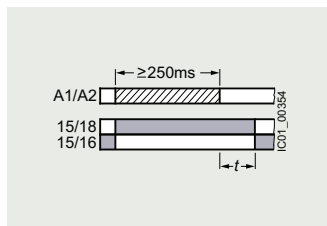

3RP2540-.A.30, 1 CO, OFF-delay (N)¹⁾

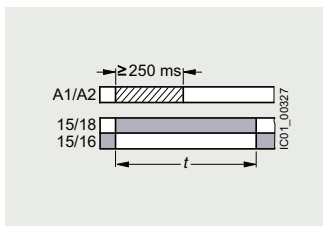

3RP2540-.A.30, 1 CO, positive passing make contact (O)¹⁾

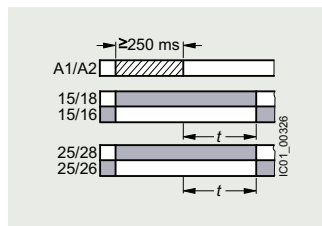

3RP2540-.B.30, 2 CO, OFF-delay (N)¹⁾

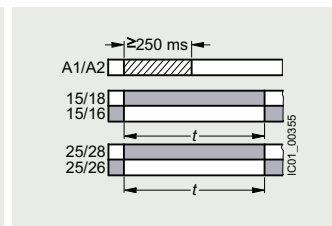

3RP2540-.B.30, 2 CO, positive passing make contact (O)¹⁾

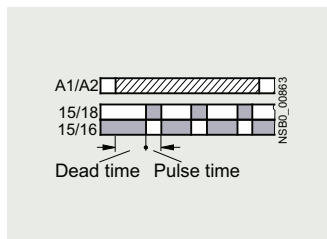

3RP2555-.AW30, 1 CO, flashing, asymmetrical, starting with interval (clock-pulse relay)

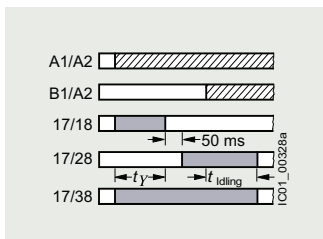

3RP2560-.SW30, 3 NO, star-delta (wye-delta) function with coasting function (idling)



3RP257-.NM20, 2 NO, star-delta (wye-delta) function

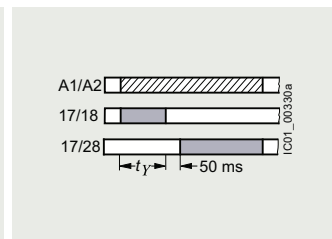

3RP257-.NW30, 2 NO, star-delta (wye-delta) function

Legend

- Timing relay energized
- Contact closed
- Contact open

¹⁾ 3RP2540 has a double function:
Function N = OFF-delay
Function O = Positive passing make contact.

Possibilities of operation of the 3RP2560-SW30 timing relay

Operation 1: Start contact B./A2 is open when control supply voltage A./A2 is applied

The control supply voltage is applied to A./A2 and there is no control signal on B./A2. This starts the $\Upsilon\Delta$ timing. The idling time (coasting time) is started by applying a control signal to B./A2. When the set time t_{idling} (30 to 600 s) has elapsed, the output relays (17/38 and 17/28) are reset. If the control signal on B./A2 is switched off (minimum OFF period 270 ms), a new timing is started.

Note:

Observe response time (dead time) of 400 ms on energizing control supply voltage until contacts 17/18 and 17/38 close.

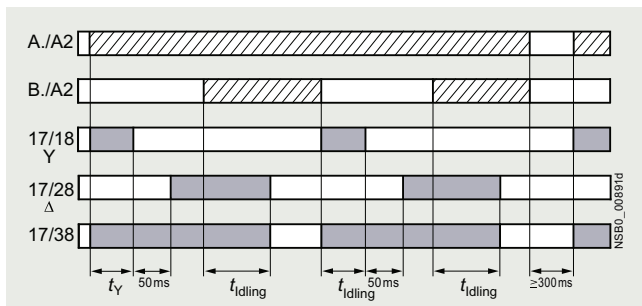

Operation 1

Operation 2: Start contact B./A2 is closed when control supply voltage A./A2 is applied

If the control signal B./A2 is already present when the control supply voltage A./A2 is applied, **no** timing is started. The timing is only started when the control signal B./A2 is switched off.

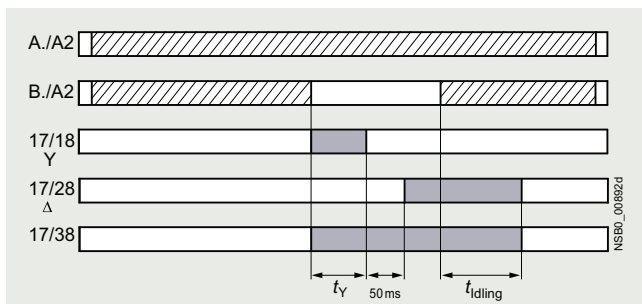

Operation 2

Operation 3: Start contact B./A2 closes while star time is running

If the control signal B./A2 is applied again during the star time, the idling time starts and the timing is terminated normally.

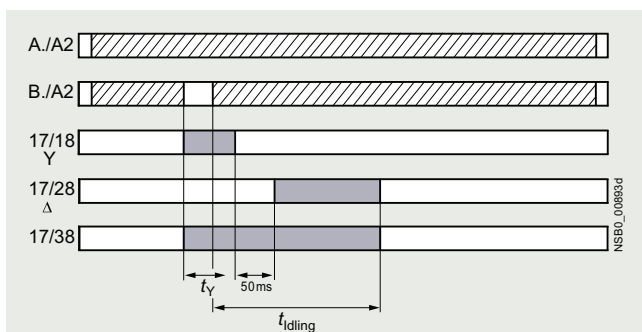

Operation 3

Operation 4: Start contact B./A2 opens while delta time is running and is applied again

If the control signal on B./A2 is applied and switched off again during the delta time, although the idling time has not yet elapsed, the idling time (coasting time) is reset to zero. If the control signal is re-applied to B./A2, the idling time is restarted.

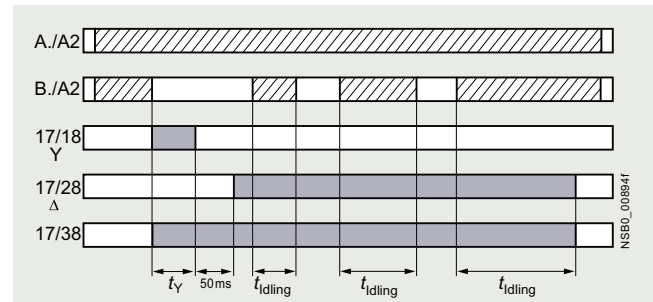

Operation 4

Legend

- Timing relay energized
- Contact closed
- Contact open

t_Y = Star time 1 to 20 s

t_{idling} = Idling time (coasting time) 30 to 600 s

Note:

The following applies to all operations: The pressure switch controls the timing via B./A2.

Application example based on standard operation

(operation 1): For example, use of 3RP2560 for compressor control

Frequent starting of compressors strains the network, the machine, and the increased costs for the operator. The new timing relay prevents frequent starting at times when there is high demand for compressed air. A special control circuit prevents the compressor from being switched off immediately when the required air pressure in the tank has been reached. Instead, the valve in the intake tube is closed and the compressor runs in "Idling" mode, i.e. in no-load operation for a specific time which can be set from 30 to 600 s.

If the pressure falls within this time, the motor does not have to be restarted again, but can return to rated load operation from no-load operation.

If the pressure does not fall within this idling time, the motor is switched off.

The pressure switch controls the timing via B./A2.

The control supply voltage is applied to A./A2 and the start contact B./A2 is open, i.e. there is no control signal on B./A2 when the control supply voltage is applied. The pressure switch signals "too little pressure in system" and starts the timing by way of terminal B./A2. The compressor is started, enters $\Upsilon\Delta$ operation, and fills the pressure tank.

When the pressure switch signals "sufficient pressure", the control signal B./A2 is applied, the idling time (coasting time) is started, and the compressor enters no-load operation for the set period of time from 30 to 600 s. The compressor is then switched off. The compressor is only restarted if the pressure switch responds again (low pressure).

Monitoring and control devices

Relays

Timing relays

SIRIUS 3RP25 timing relays, 17.5 mm and 22.5 mm

Selection and ordering data

PU (UNIT, SET, M) = 1
 PS* = 1 unit
 PG = 41H

Multi-unit
 packaging,
 see
 page 16/7.



3RP2505-2AB30



3RP2505-2BB30



3RP2525-2AW30



3RP2540-2AW30



3RP2555-2AW30



3RP2576-2NW30

Number of NO contacts	Number of CO contacts	Semi-conductor output	Adjustable time	Control supply voltage		Protective coating on printed circuit board	Screw terminals		Spring-loaded terminals (push-in)	
				at AC at 50/60 Hz	at DC		Article No.	Price per PU	Article No.	Price per PU
13 functions										
0	0	0	1	No	0.05 s ... 100 h	24 12 ... 240	24 12 ... 240	No No Yes	3RP2505-1AB30 3RP2505-1AW30 --	3RP2505-2AB30 3RP2505-2AW30 3RP2505-2AW30-0AX0
0	1	0	0	Yes	0.05 s ... 100 h	12 ... 240	12 ... 240	No	3RP2505-1CW30	3RP2505-2CW30
13 functions, suitable for railway applications										
0	0	0	2 ¹⁾	No	0.05 s ... 100 h	24 ... 240	24 ... 240	No Yes	3RP2505-1RW30 --	3RP2505-2RW30 3RP2505-2RW30-0AX0
27 functions										
0	0	0	2 ²⁾	No	0.05 s ... 100 h	24 400 ... 440 12 ... 240	24 -- 12 ... 240	No No No Yes	3RP2505-1BB30 3RP2505-1BT20 3RP2505-1BW30 --	3RP2505-2BB30 3RP2505-2BT20 3RP2505-2BW30 3RP2505-2BW30-0AX0
ON-delay										
0	0	0	1	No	0.5 ... 10 s 1 ... 30 s 5 ... 100 s 0.05 s ... 100 h	12 ... 240 12 ... 240 12 ... 240 12 ... 240	12 ... 240 12 ... 240 12 ... 240 12 ... 240	No No No No	3RP2511-1AW30 3RP2512-1AW30 3RP2513-1AW30 3RP2525-1AW30	3RP2511-2AW30 3RP2512-2AW30 3RP2513-2AW30 3RP2525-2AW30
0	0	0	2	No	0.05 s ... 100 h	24 12 ... 240	24 12 ... 240	No No	3RP2525-1BB30 3RP2525-1BW30	3RP2525-2BB30 3RP2525-2BW30
0	1	0	0	Yes	0.05 s ... 240 s	12 ... 240	12 ... 240	No	3RP2527-1EW30	3RP2527-2EW30
OFF-delay with control signal										
0	0	0	1	No	0.05 s ... 100 h	12 ... 240	12 ... 240	No	3RP2535-1AW30	3RP2535-2AW30
OFF-delay without control signal, non-volatile, passing make contact										
0	0	0	1 ³⁾	No	0.05 s ... 600 s	24 12 ... 240	24 12 ... 240	No No	3RP2540-1AB30 3RP2540-1AW30	3RP2540-2AB30 3RP2540-2AW30
0	0	0	2 ³⁾	No	0.05 s ... 600 s	24 12 ... 240	24 12 ... 240	No No	3RP2540-1BB30 3RP2540-1BW30	3RP2540-2BB30 3RP2540-2BW30
Clock-pulse relay, flashing, asymmetrical										
0	0	0	1	No	0.05 s ... 100 h	12 ... 240	12 ... 240	No	3RP2555-1AW30	3RP2555-2AW30
Star-delta (wye-delta) function with coasting function (idling)										
1	2	0	0	No	1 ... 20 s	12 ... 240	12 ... 240	No	3RP2560-1SW30	3RP2560-2SW30
Star-delta (wye-delta) function										
1	1	0	0	No	1 ... 20 s	380 ... 440 ⁴⁾ 12 ... 240	-- 12 ... 240	No No	3RP2574-1NM20 3RP2574-1NW30	3RP2574-2NM20 3RP2574-2NW30
1	1	0	0	No	3 ... 60 s	380 ... 440 ⁴⁾ 12 ... 240	-- 12 ... 240	No No	3RP2576-1NM20 3RP2576-1NW30	3RP2576-2NM20 3RP2576-2NW30

1) Force-guided contacts.

2) Optionally 1 CO delayed + 1 CO instantaneous.

3) Setting of output contacts in as-supplied state not defined (bistable relay). Application of the control supply voltage once results in contact changeover to the correct setting.

4) With 3RP2574-.NM20 and 3RP2576-.NM20, connection of 200 to 240 V AC, 50/60 Hz control supply voltage is also possible.

Other device versions with protective coating on the printed circuit board are available on request.

Notes:

Accessories, see page 10/45.











In the case of 3RP2505, the functions can be adjusted by means of function selector switches on the device. With a set of foil labels the timing relay can be legibly marked with the functions which can be selected on the timing relay. This is included in the scope of supply. The same potential must be applied to terminals A. and B.

For functions, see the overview of functions on page 10/35.

Accessories

More information

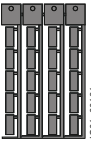
You can find information on configuring and dimensioning the accessories in the Equipment Manual, see <https://support.industry.siemens.com/cs/ww/en/view/103532830>

Version	Article No.	Price per PU	PU (UNIT, SET, M)	PS*	PG
Terminals for SIRIUS devices in the industrial DIN-rail enclosure					
 3ZY1122-1BA00	Removable terminals, without inscription <ul style="list-style-type: none"> • 2-pole, up to 1 x 4 mm² or 2 x 2.5 mm² 	Screw terminals  3ZY1122-1BA00	1	6 units	41L
 3ZY1122-2BA00	Removable terminals, without inscription <ul style="list-style-type: none"> • 2-pole, up to 1 x 4 mm² or 2 x 1.5 mm² (in shared end sleeve) 	Spring-loaded terminals (push-in)  3ZY1122-2BA00	1	6 units	41L
Accessories for enclosures					
 3ZY1321-2AA00	Sealing covers <ul style="list-style-type: none"> • 17.5 mm wide • 22.5 mm wide 	3ZY1321-1AA00 3ZY1321-2AA00	1	5 units	41L
 3ZY1311-0AA00	Push-in lugs for wall mounting (Two lugs are required per device)	3ZY1311-0AA00	1	10 units	41L
 3ZY1440-1AA00	Coding pins For removable terminals of SIRIUS devices in the industrial DIN-rail enclosure; enable the mechanical coding of terminals	3ZY1440-1AA00	1	12 units	41L
 3ZY1450-1AB00	Hinged covers Replacement covers, without terminal labeling, titanium gray <ul style="list-style-type: none"> • 17.5 mm wide • 22.5 mm wide 	3ZY1450-1AA00 3ZY1450-1AB00	1	5 units	41L
 3ZY1450-1AB00			1	5 units	41L
Blank labels					
 3RT2900-1SB20	Unit labeling plates¹⁾ For SIRIUS devices <ul style="list-style-type: none"> • 10 mm x 7 mm, titanium gray • 20 mm x 7 mm, titanium gray 	3RT2900-1SB10 3RT2900-1SB20	100	816 units	41B
			100	340 units	41B
Tools for opening spring-loaded terminals					
 3RA2908-1A	Screwdriver For all SIRIUS devices with spring-loaded terminals <p>Length approx. 200 mm, 3.0 mm x 0.5 mm, titanium gray/black, partially insulated</p>	Spring-loaded terminals (push-in)  3RA2908-1A	1	1 unit	41B

¹⁾ PC labeling system for individual inscription of unit labeling plates available from: murrplastik Systemtechnik GmbH, see page 16/18.

Monitoring and control devices

Relays
Timing relays

SIRIUS 3RP20 timing relays, 45 mm

Overview

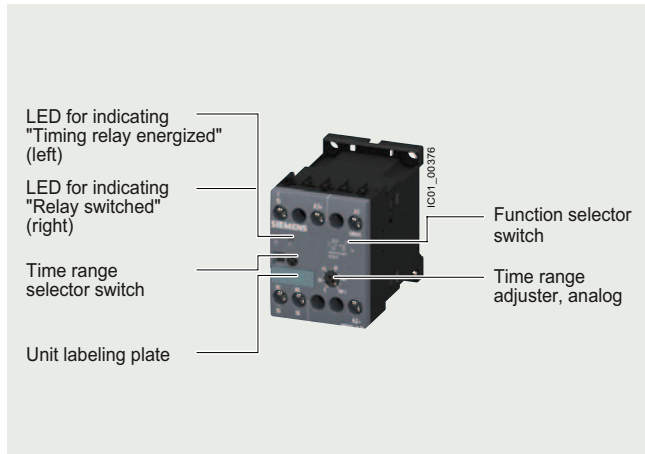

SIRIUS 3RP20 timing relay

SIRIUS 3RP20 electronic timing relays for use in control systems and mechanical engineering with:

- 1 or 2 CO contacts
- Multifunction or monofunction
- Wide voltage range or combination voltage
- Single or selectable time ranges
- Switch position indication and voltage indication by LED

Standards

The timing relays comply with:

- IEC 60721-3-3 "Classification of environmental conditions"
- IEC 61812-1 "Specified time relays for industrial use"
- IEC 61000-6-2 and IEC 61000-6-4 "Electromagnetic compatibility"
- IEC 60947-5-1 "Low-voltage switchgear and controlgear – Electromechanical control circuit devices"
- IEC 60947-1, Annex N "Protective separation"

Multifunction

The functions of the 3RP2005 multifunctional timing relays can be set by means of the function selector switch. The timing relay can be set clearly and unmistakably using insert labels for various functions. The corresponding labels can be ordered as an accessory. The same potential must be applied to terminals A. and B.

For functions, see 3RP2901 label set, page 10/51.

Note:

The activation of loads parallel to the start input is not permissible when using AC control voltage.

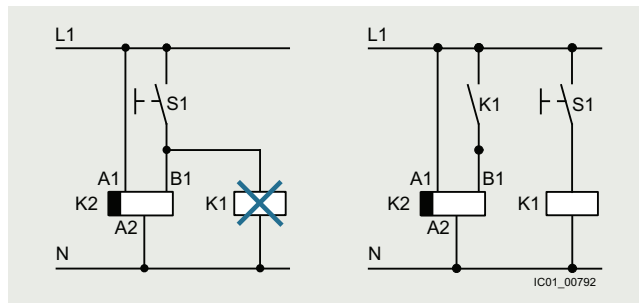

Diagrams

Accessories

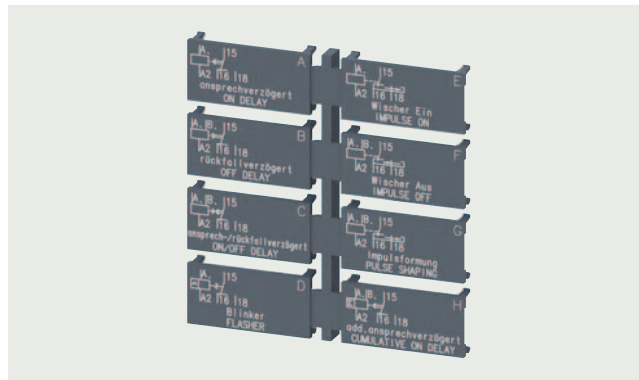

Label set for marking the multifunctional relay

Article number scheme

Product versions		Article number					
SIRIUS timing relays, 45 mm enclosure		3RP20	<input type="checkbox"/>	<input type="checkbox"/>	<input type="checkbox"/>	<input type="checkbox"/>	3 0
Product function/ time ranges	Multifunction	0 5					15 time ranges 0.05 s... 100 h
	ON-delay	2 5					15 time ranges 0.05 s... 100 h
Connection type	Screw terminals				1		
	Spring-loaded terminals				2		
Contacts	1 CO				A		
	2 CO				B		
Control supply voltage	24 V AC/DC/100 ... 127 V AC				Q		Combination voltage
	24 V AC/DC/200 ... 240 V AC				P		Combination voltage
	24 ... 240 V AC/DC				W		Wide voltage range
Example		3RP20	0 5	- 1	A P	3 0	

Note:

The article number scheme shows an overview of product versions for better understanding of the logic behind the article numbers.

For your orders, please use the article numbers quoted in the selection and ordering data.



Benefits

- Suitable for 3RT miniature contactors
- Uniform design
- Ideal for small distance between DIN rails and/or for low mounting depth, e.g. in control boxes
- Labels are used on the multifunctional timing relay to document the function that has been set

Application

Timing relays are used in control, starting, and protective circuits for all switching operations involving time delays. They guarantee a high level of functionality and a high repeat accuracy of timer settings.

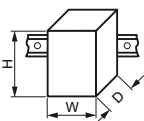
Technical specifications

More information	
Technical specifications, see https://support.industry.siemens.com/cs/ww/en/ps/16356/td Operating Instructions, see https://support.industry.siemens.com/cs/ww/en/view/11647144	Internal circuit diagrams, see CAx Download Manager https://support.industry.siemens.com/my/ww/en/CAxOnline#CAxOnline FAQs, see https://support.industry.siemens.com/cs/ww/en/ps/16356/faq
Type	3RP2005, 3RP2025
Dimensions (W x H x D)	mm 45 x 57 x 73
	
Rated insulation voltage Pollution degree 3 Overvoltage category III	V AC 300
Permissible ambient temperature • During operation • During storage	°C -25 ... +60 °C -40 ... +85
Operating range of excitation¹⁾	0.85 ... 1.1 x U _N at AC; 0.8 ... 1.25 x U _N at DC; 0.95 ... 1.05 times the rated frequency
Mechanical endurance	Operating cycles 10 x 10 ⁶
Electrical endurance at I_e	Operating cycles 1 x 10 ⁵
Connection type	 Screw terminals
• Terminal screw • Solid • Finely stranded with end sleeve • Stranded • AWG cables • Tightening torque	mm ² M3 (for standard screwdriver, size 2 and Pozidriv 2) mm ² 2 x (0.5 ... 1.5) ²⁾ , 2 x (0.75 ... 2.5) ²⁾ mm ² 2 x (0.5 ... 1.5) ²⁾ , 2 x (0.75 ... 2.5) ²⁾ AWG 2 x (0.5 ... 1.5) ²⁾ , 2 x (0.75 ... 2.5) ²⁾ AWG 2 x (18 ... 14) Nm 0.8 ... 1.2
Connection type	 Spring-loaded terminals
• Solid • Finely stranded with end sleeve • Finely stranded without end sleeve • AWG cables, solid or stranded • Max. outer diameter of the conductor insulation	mm ² 2 x (0.25 ... 2.5) mm ² 2 x (0.25 ... 1.5) mm ² 2 x (0.25 ... 2.5) AWG 2 x (24 ... 14) mm 3.6

¹⁾ If nothing else is stated.

²⁾ If two different conductor cross-sections are connected to one clamping point, both cross-sections must lie in one of the ranges specified.

Monitoring and control devices

Relays

Timing relays

SIRIUS 3RP20 timing relays, 45 mm

3RP20 function diagrams and 3RP2901 label set

1 CO contact

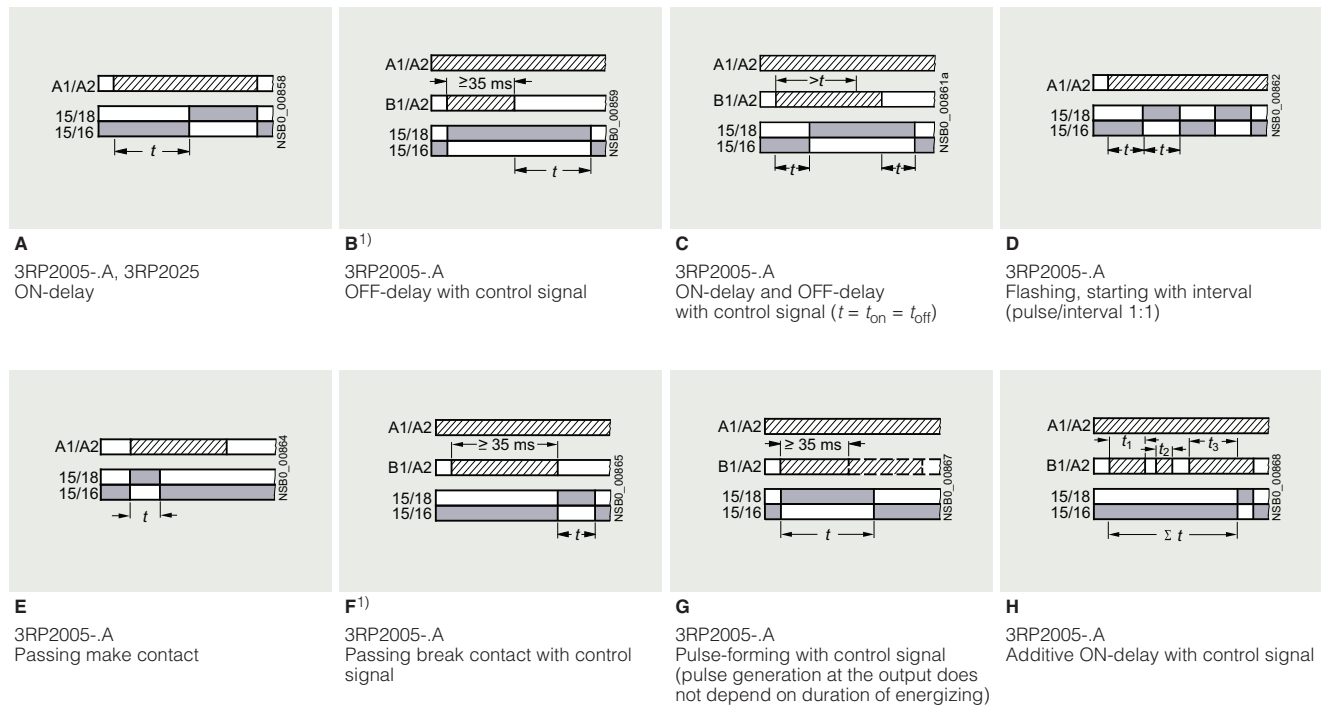

Legend

A ... H Identification letters for 3RP2005

▨ Timing relay energized

■ Contact closed

□ Contact open

¹⁾ A new control signal at terminal B, after the operating time has started, resets the operating time to zero (retriggerable).

2 CO contacts

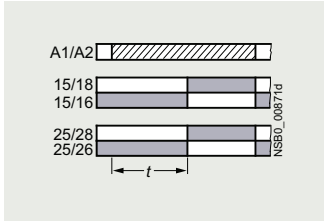

A
3RP2005-B
ON-delay

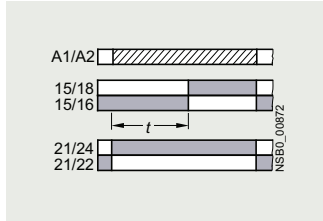

A•
3RP2005-B
ON-delay and instantaneous contact

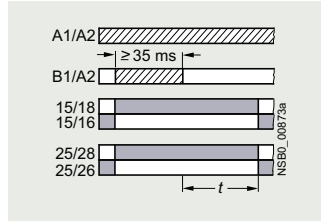

B¹⁾
3RP2005-B
OFF-delay with control signal

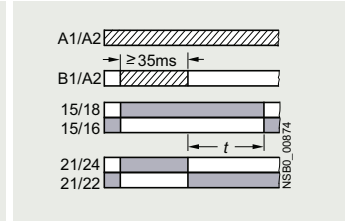

B•¹⁾
3RP2005-B
OFF-delay with control signal
and instantaneous contact

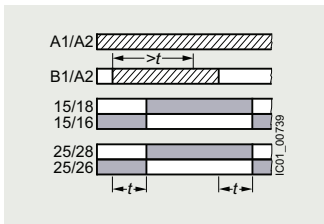

C
3RP2005-B
ON-delay and OFF-delay
with control signal ($t = t_{on} = t_{off}$)

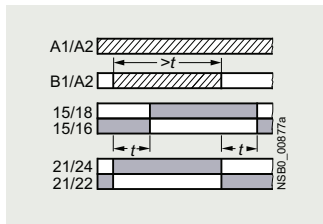

C•
3RP2005-B
ON-delay and OFF-delay
with control signal and instantaneous
contact ($t = t_{on} = t_{off}$)

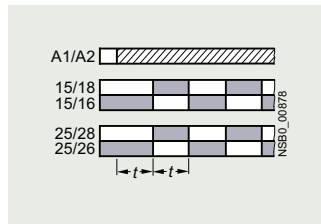

D
3RP2005-B
Flashing, starting with interval
(pulse/interval 1:1)

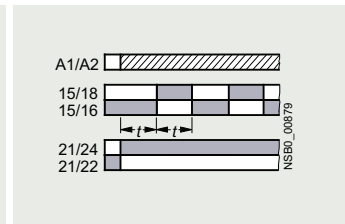

D•
3RP2005-B
Flashing, starting with interval
(pulse/interval 1:1) and instantaneous
contact

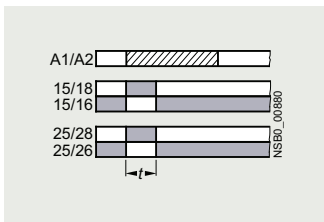

E
3RP2005-B
Passing make contact



E•
3RP2005-B
Passing make contact and
instantaneous contact

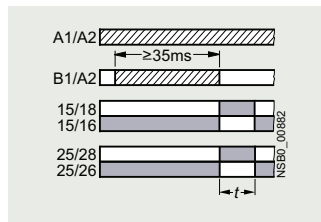

F¹⁾
3RP2005-B
Passing break contact with control
signal

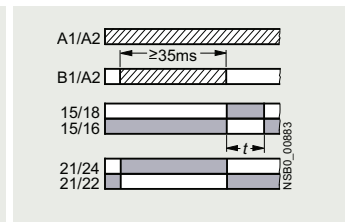

F•¹⁾
3RP2005-B
Passing break contact with control
signal and instantaneous contact

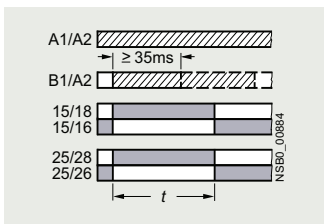

G
3RP2005-B
Pulse-forming with control signal
(pulse generation at the output does
not depend on duration of energizing)

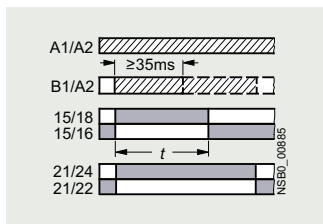

G•
3RP2005-B
Pulse-forming with control signal
and instantaneous contact (pulse
generation at the output does not
depend on duration of energizing)

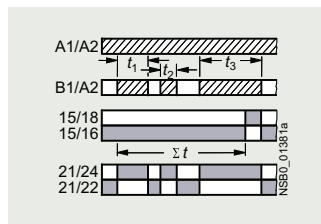

H•
3RP2005-B
Additive ON-delay with control signal
and instantaneous contact



YΔ
3RP2005-B
Star-delta (wye-delta) function

Legend

A ... H Identification letters for 3RP2005

• instantaneous contact

▨ Timing relay energized

■ Contact closed

□ Contact open

¹⁾ A new control signal at terminal B, after the operating time has started, resets the operating time to zero (retriggerable).

Monitoring and control devices

Relays

Timing relays

SIRIUS 3RP20 timing relays, 45 mm

Selection and ordering data

PU (UNIT, SET, M) = 1
 PS* = 1 unit
 PG = 41H



3RP2005-1AP30



3RP2005-1BW30



3RP2005-2AP30



3RP2005-2BW30

Version	Time range t	Rated control supply voltage U_s	Screw terminals	Spring-loaded terminals
		50/60 Hz AC		
		DC		
		V	Article No.	Article No.
		V	Price per PU	Price per PU

3RP2005 timing relays, multifunction, 15 time ranges

The functions can be adjusted by means of rotary switches. The 3RP2005 timing relay can be set clearly and unmistakably using insert labels for various functions. The corresponding labels can be ordered as an accessory. The same potential must be applied to terminals A. and B. For functions, see 3RP2901 label set, page 10/51.

With LED and 1 CO contact ¹⁾ , 8 functions	0.05 ... 1 s 0.15 ... 3 s 0.5 ... 10 s 1.5 ... 30 s	24/100 ... 127 24/200 ... 240	24 24	3RP2005-1AQ30 3RP2005-1AP30	3RP2005-2AQ30 3RP2005-2AP30
With LED and 2 CO contacts, 16 functions	0.05 ... 1 min 5 ... 100 s 0.15 ... 3 min 0.5 ... 10 min 1.5 ... 30 min 0.05 ... 1 h 5 ... 100 min 0.15 ... 3 h 0.5 ... 10 h 1.5 ... 30 h 5 ... 100 h ∞ ²⁾	24 ... 240 ³⁾	24 ... 240 ⁴⁾	3RP2005-1BW30	3RP2005-2BW30

3RP2025 timing relays, ON-delay, 15 time ranges

With LED and 1 CO contact ¹⁾	0.05 ... 1 s 0.15 ... 3 s 0.5 ... 10 s 1.5 ... 30 s 0.05 ... 1 min 5 ... 100 s 0.15 ... 3 min 0.5 ... 10 min 1.5 ... 30 min 0.05 ... 1 h 5 ... 100 min 0.15 ... 3 h 0.5 ... 10 h 1.5 ... 30 h 5 ... 100 h ∞ ²⁾	24/100 ... 127 24/200 ... 240	24 24	3RP2025-1AQ30 3RP2025-1AP30	3RP2025-2AQ30 3RP2025-2AP30
---	---	----------------------------------	----------	--------------------------------	--------------------------------

Accessories, see page 10/51.

- 1) Units with protective separation.
- 2) With ∞ switch position no timing. For test purposes (ON/OFF function) on site. Relay is constantly on when activated, or relay remains constantly off when activated. Depending on which function is set.
- 3) Operating range 0.8 to 1.1 x U_s .
- 4) Operating range 0.7 to 1.1 x U_s .

Accessories

Version	Function	Identifi- cation letter	Use	Article No.	Price per PU	PU (UNIT, SET, M)	PS*	PG
---------	----------	-------------------------------	-----	-------------	-----------------	-------------------------	-----	----

Label sets for 3RP20

Accessories for 3RP20 (not included in the scope of supply).
The label set can be used to label timing relays with the set function
in English and German.



3RP2901-0A

1 label set (1 unit) with 8 functions	<ul style="list-style-type: none"> • ON-delay • OFF-delay with control signal • ON-delay and OFF-delay with control signal • Flashing, starting with interval • Passing make contact • Passing break contact with control signal • Pulse-forming with control signal • Additive ON-delay with control signal 	A B C D E F G H	For devices with 1 CO	3RP2901-0A		1	5 units	41H
--	--	--------------------------------------	--------------------------	-------------------	--	---	---------	-----



3RP2901-0B

1 label set (1 unit) with 16 functions	<ul style="list-style-type: none"> • ON-delay • OFF-delay with control signal • ON-delay and OFF-delay with control signal • Flashing, starting with interval • Passing make contact • Passing break contact with control signal • Pulse-forming with control signal • ON-delay and instantaneous contact • OFF-delay with control signal and instantaneous contact • ON-delay and OFF-delay with control signal and instantaneous contact • Flashing, starting with interval and instantaneous contact • Passing make contact and instantaneous contact • Passing break contact with control signal and instantaneous contact • Pulse-forming with control signal and instantaneous contact • Additive ON-delay with control signal and instantaneous contact • Star-delta (wye-delta) function 	A B C D E F G A• B• C• D• E• F• G• H• YΔ	For devices with 2 CO	3RP2901-0B		1	5 units	41H
---	--	---	--------------------------	-------------------	--	---	---------	-----

Blank labels

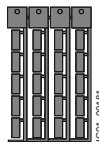

3RT2900-1SB20

Unit labeling plates¹⁾ For SIRIUS devices	For 3RP20			3RT2900-1SB20		100	340 units	41B
--	-----------	--	--	----------------------	--	-----	-----------	-----

- 20 mm x 7 mm, titanium gray

¹⁾ PC labeling system for individual inscription
of unit labeling plates available from:
murrplastik Systemtechnik GmbH,
see page 16/18.

Monitoring and control devices

Relays

Timing relays

7PV15 timing relays, 17.5 mm

Overview



7PV15 timing relay

Electronic timing relays for general use in control systems, mechanical engineering and infrastructure with:

- 1 or 2 CO contacts
- Multifunction or monofunction
- Wide voltage range or combination voltage
- Single or selectable time ranges
- Switch position indication and voltage indication by LED

Standards

The timing relays comply with:

- IEC 60721-3-3 "Classification of environmental conditions"
- IEC 61812-1 "Specified time relays for industrial use"
- IEC 61000-6-2 and IEC 61000-6-4 "Electromagnetic compatibility"
- IEC 60947-5-1 "Low-voltage switchgear and controlgear – Electromechanical control circuit devices"
- DIN 43880 "Built-in equipment for electrical installations; overall dimensions and related mounting dimensions"

Multifunction

The functions of the 7PV1508-1A multifunctional timing relay can be set by means of rotary switches. The identification letters A to G are printed on the front alongside the rotary selector switch of the unit. The related function can be found in the form of a bar graph on the side of the device.

Enclosure version

All timing relays are suitable for snap-on mounting onto TH 35 DIN rails according to IEC 60715. The enclosure complies with DIN 43880, 1 MW.

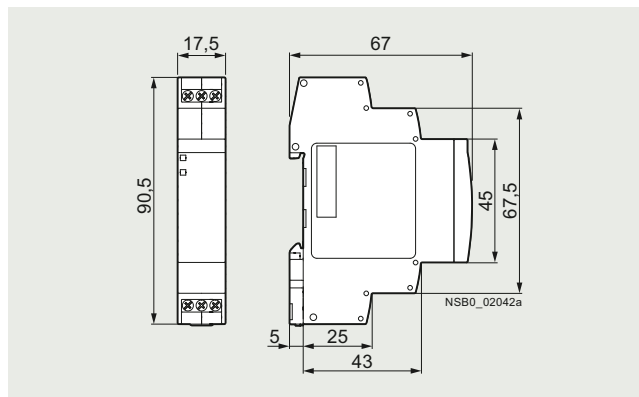

Dimensions

Note:

The activation of loads parallel to the start input is not permissible when using AC control voltage.

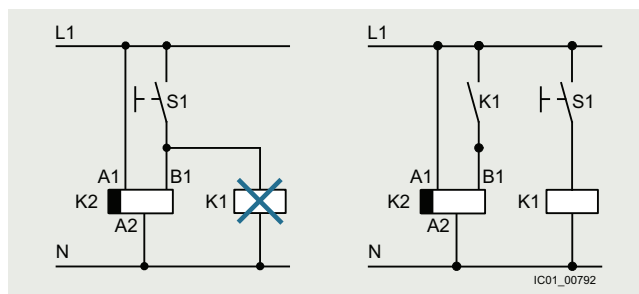

Diagrams

Article number scheme

Product versions		Article number	
Timing relays in industrial enclosure, 17.5 mm		7PV15 □ □ - 1 □ □ 3 0	
Product function/ time ranges	Multifunction	0 8	7 time ranges 0.05 s ... 100 h
	ON-delay	1 1	1 time range 0.05 ... 1 s
		1 2	1 time range 0.5 ... 10 s
		1 3	1 time range 5 ... 100 s
		1 8	7 time ranges 0.05 s ... 100 h
	OFF-delay with control signal	3 8	7 time ranges 0.05 s ... 100 h
	OFF-delay without control signal	4 0	7 time ranges 0.05 s ... 100 s
	Clock-pulse relay	5 8	7 time ranges 0.05 s ... 100 h
	Star-delta (wye-delta) function	7 8	7 time ranges 0.05 s ... 100 h
Contacts	e.g. A = 1 CO	□	
Control supply voltage	e.g. W = 12 ... 240 V AC/DC	□	Combination voltage
Example		7PV15 0 8 - 1 A W 3 0	

Note:

The article number scheme shows an overview of product versions for better understanding of the logic behind the article numbers.

For your orders, please use the article numbers quoted in the selection and ordering data.

Benefits

- Wide voltage range 12 to 240 V AC/DC
- High switching capacity, e.g. AC-15 at 230 V, 3 A
- Combination voltage, e.g. 24 V AC/DC and 200 to 240 V AC
- Changes to the time range during operation
- Changes to the function in the de-energized state
- High level of functionality and a high repeat accuracy of timer settings
- Integrated surge suppressor
- Function charts printed on the side of the device for reliable device adjustment

Application

Timing relays are used in control, starting and protective circuits for all switching operations involving time delays, e.g. in functional buildings, airports, building industry, etc.

Technical specifications

More information		
Technical specifications, see https://support.industry.siemens.com/cs/ww/en/ps/16358/td	Operating Instructions and internal circuit diagrams, see https://support.industry.siemens.com/cs/ww/en/view/35210295	
TIA Selection Tool Cloud (TST Cloud), see www.siemens.com/tstcloud/?node=SIRIUSRelais		
Type	7PV15	
Rated insulation voltage Pollution degree 2, overvoltage category III	V AC	300
Permissible ambient temperature	°C	-25 ... +55
• During operation	°C	-40 ... +70
• During storage		
Operating range of excitation¹⁾		0.85 ... 1.1 x U _s
Rated operational current I_e		
• AC-15 at 24 ... 240 V, 50 Hz	A	3
• DC-13 at		
- 24 V	A	1
- 125 V	A	0.2
Uninterrupted thermal current I_{th}	A	5
Mechanical endurance	Operating cycles	1 x 10 ⁷
Electrical endurance at I_e	Operating cycles	1 x 10 ⁵
Connection type	Screw terminals	
• Terminal screw		M3 (for standard screwdriver, size 2 and Pozidriv 2)
• Solid	mm ²	1 x (0.2 ... 2.5)
• Finely stranded with end sleeve	mm ²	1 x (0.25 ... 1.5)
• Finely stranded without end sleeve	mm ²	1 x (0.2 ... 1.5)
• AWG cables, solid or stranded	AWG	1 x (24 ... 14)
• Tightening torque	Nm	0.4 ... 0.5

¹⁾ If nothing else is stated.

Monitoring and control devices

Relays

Timing relays

7PV15 timing relays, 17.5 mm

7PV15 function diagrams

1 CO contact

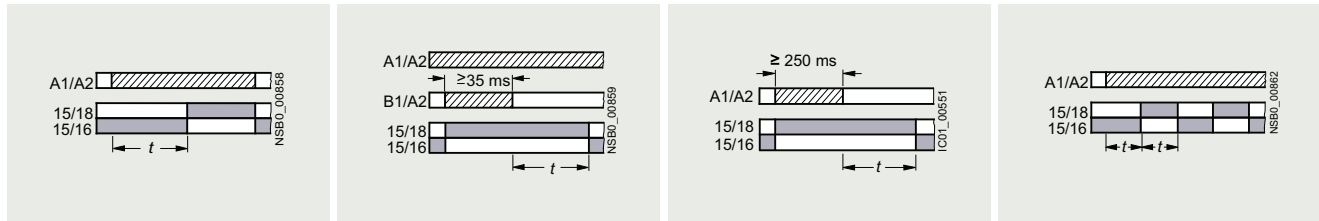

A
7PV1508-1A, 7PV1511, 7PV1512,
7PV1513, 7PV1518
ON-delay

B¹⁾
7PV1508-1A, 7PV1538
OFF-delay with control signal

--
7PV1540
OFF-delay without control signal

C
7PV1508-1A
Flashing, starting with interval
(pulse/interval 1:1)

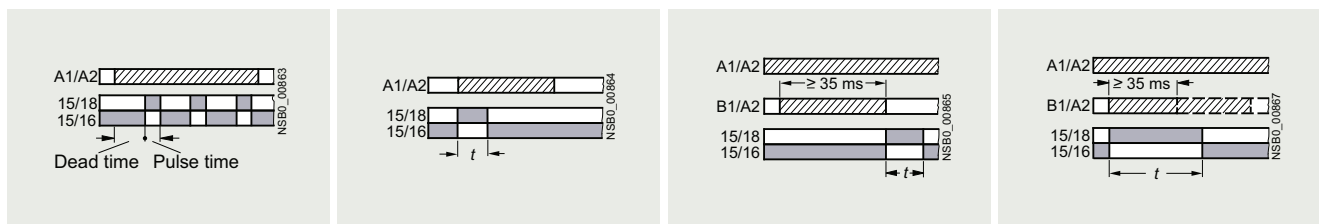

--
7PV1558
Clock-pulse, starting with interval
(dead time, pulse time, and time
ranges each separately adjustable)

D
7PV1508-1A
Passing make contact

E¹⁾
7PV1508-1A
Passing break contact with control
signal

F
7PV1508-1A
Pulse-forming with control signal
(pulse generation at the output does
not depend on duration of energizing)

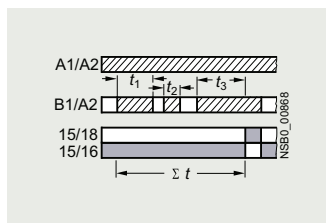

G
7PV1508-1A
Additive ON-delay with control signal

Legend

A ... G Identification letters for 7PV1508

▨ Timing relay energized

■ Contact closed

□ Contact open

¹⁾ A new control signal at terminal B, after the operating time has started, resets the operating time to zero (retriggerable).

Note:

With the 7PV1508-1A multifunctional timing relay the identification letters A to G are printed on the front alongside the rotary selector switch of the unit. The related function can be found in the form of a bar graph on the side of the device.

2 CO contacts

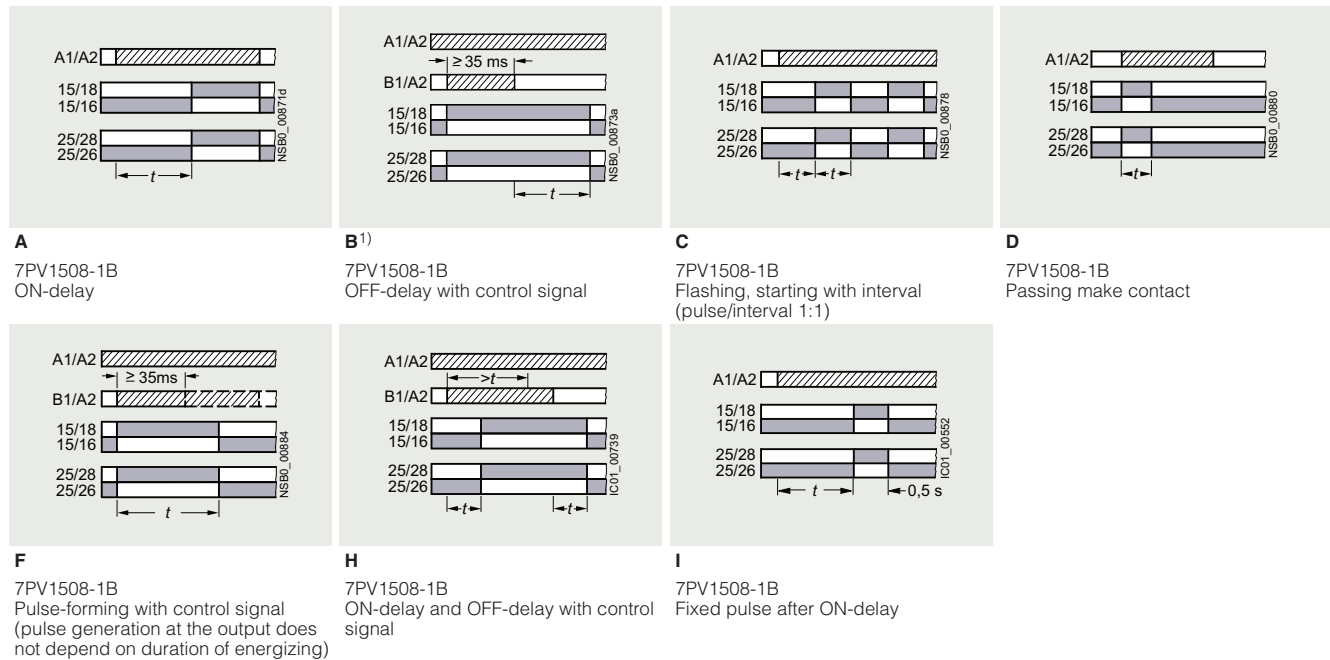

2 NO contacts



--

7PV1578
Star-delta (wye-delta) function²⁾

Legend

A ... D, F, H, I Identification letters for 7PV1508

▨ Timing relay energized

■ Contact closed

□ Contact open

¹⁾ A new control signal at terminal B, after the operating time has started, resets the operating time to zero (retriggerable).

²⁾ With 7PV1578 the contacts 16 and 26 are not needed for the star-delta (wye-delta) function.

Note:

With the 7PV1508-1B multifunctional timing relay the identification letters A to D, F, H, I are printed on the front alongside the rotary selector switch of the unit. The related function can be found in the form of a bar graph on the side of the device.

Monitoring and control devices

Relays

Timing relays

7PV15 timing relays, 17.5 mm

Selection and ordering data

Version	Time range t adjustable by rotary switch to	Rated control supply voltage U_s		Screw terminals	PU (UNIT, SET, M)	PS*	PG
		50/60 Hz AC	DC				
		V	V	Article No.	Price per PU		
7PV1508-1AW30							
7PV1512-1AP30							
7PV1518-1AW30							
7PV1538-1AW30							
7PV1540-1AW30							
7PV1558-1AW30							
7PV1578-1BW30							
7PV1508 timing relays, multifunction, 7 time ranges							
The functions can be adjusted by means of rotary switches. The same potential must be applied to terminals A. and B.							
With LED and 1 CO contact, 7 functions	0.05 ... 1 s 0.5 ... 10 s 5 ... 100 s	12 ... 240	12 ... 240	7PV1508-1AW30	1	1 unit	41H
With LED and 2 CO contacts, 7 functions	30 s ... 10 min 3 min ... 1 h 30 min ... 10 h 5 ... 100 h	12 ... 240	12 ... 240	7PV1508-1BW30	1	1 unit	41H
7PV151. timing relays, ON-delay, 1 time range							
With LED and 1 CO contact	0.05 ... 1 s	24/200 ... 240	24	7PV1511-1AP30	1	1 unit	41H
	0.5 ... 10 s	24/100 ... 127	24	7PV1512-1AQ30	1	1 unit	41H
		24/200 ... 240	24	7PV1512-1AP30	1	1 unit	41H
	5 ... 100 s	24/100 ... 127	24	7PV1513-1AQ30	1	1 unit	41H
		24/200 ... 240	24	7PV1513-1AP30	1	1 unit	41H
7PV1518 timing relays, ON-delay, 7 time ranges							
With LED and 1 CO contact	0.05 ... 1 s 0.5 ... 10 s 5 ... 100 s 30 s ... 10 min 3 min ... 1 h 30 min ... 10 h 5 ... 100 h	12 ... 240	12 ... 240	7PV1518-1AW30	1	1 unit	41H
7PV1538 timing relays, OFF-delay, with control signal, 7 time ranges							
With LED and 1 CO contact	0.05 ... 1 s 0.5 ... 10 s 5 ... 100 s 30 s ... 10 min 3 min ... 1 h 30 min ... 10 h 5 ... 100 h	12 ... 240	12 ... 240	7PV1538-1AW30	1	1 unit	41H
7PV1540 timing relays, OFF-delay, without control signal, 7 time ranges							
With LED and 1 CO contact ¹⁾	0.05 ... 1 s 0.15 ... 3 s 0.3 ... 6 s 0.5 ... 10 s 1.5 ... 30 s 3 ... 60 s 5 ... 100 s	12 ... 240	12 ... 240	7PV1540-1AW30	1	1 unit	41H
7PV1558 timing relays, clock-pulse relay, 7 time ranges							
With LED and 1 CO contact	0.05 ... 1 s 0.5 ... 10 s 5 ... 100 s 30 s ... 10 min 3 min ... 1 h 30 min ... 10 h 5 ... 100 h	12 ... 240	12 ... 240	7PV1558-1AW30	1	1 unit	41H
7PV1578 timing relays, star-delta (wye-delta) function, 7 time ranges							
With LED and 2 NO contacts, dead interval 0.05 ... 1 s adjustable	0.05 ... 1 s 0.5 ... 10 s 5 ... 100 s 30 s ... 10 min 3 min ... 1 h 30 min ... 10 h 5 ... 100 h	12 ... 240	12 ... 240	7PV1578-1BW30	1	1 unit	41H

¹⁾ Setting of output contacts in as-supplied state not defined (bistable relay).
Application of the control supply voltage once results in contact
changeover to the correct setting.

Overview

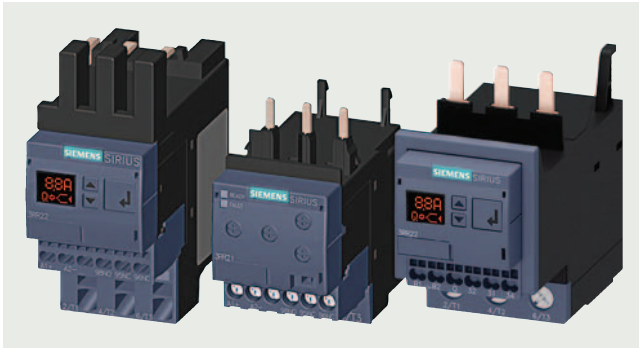

SIRIUS 3RR2242, 3RR2142, 3RR2243 current monitoring relays

More information

Homepage, see www.siemens.com/sirius-monitoring-relays
 SiePortal, see www.siemens.com/product_catalog_siep?3RR21



Video: SIRIUS 3RR2 current monitoring relays

The SIRIUS 3RR2 current monitoring relays are suitable for load monitoring of motors or other loads. In 2 or 3 phases they monitor the rms value of AC currents for overshooting or undershooting of set threshold values.

Whereas apparent current monitoring is used above all in connection with the rated torque or in case of overload, the active current monitoring option can be used to observe and evaluate the load factor over a motor's entire torque range.

The 3RR2 current monitoring relays can be integrated directly in the feeder by mounting on the 3RT2 contactor; separate wiring of the main circuit is therefore superfluous. No separate transformers are required.

For a line-oriented configuration or simultaneous use of an overload relay, terminal supports for stand-alone installation are available for separate DIN-rail mounting.

Versions

Basic versions

The basic versions with 2-phase apparent current monitoring, a CO contact output and analog adjustability provide a high level of monitoring reliability especially in the rated and overload range.

Standard versions

The standard versions monitor the current in 3 phases with selectable active current monitoring. They have additional diagnostics options such as residual current monitoring and phase sequence monitoring, and they are also suitable for monitoring motors below the rated torque. These devices have an additional independent semiconductor output, an actual value indicator, and are digitally adjustable.

Both versions are available optionally with screw or spring-loaded terminals, in each case for sizes S00 and S0. With versions of size S2, the main conducting paths always have screw terminals; the control current side can have screw or spring-loaded terminals.

Note:

In addition to the features of the standard versions, the 3RR24 monitoring relays for mounting on 3RT2 contactors for IO-Link also offer the possibility of transmitting the measured values and diagnostics data to a controller via an IO-Link. Furthermore, the devices can be parameterized on the devices themselves or via IO-Link.

For more information, see page 10/65 onwards.

3RR21 and 3RR22 overview table



Features	3RR21	3RR22	Benefits
General data			
Sizes	S00, S0, S2	S00, S0, S2	<ul style="list-style-type: none"> • Are coordinated with the dimensions, connections and technical characteristics of the other devices in the SIRIUS modular system (contactors, soft starters, etc.) • Permit the mounting of slim-line and compact load feeders in widths of 45 mm (S00 and S0) and 55 mm (S2) • Simplify configuration
Dimensions in mm (W x H x D)			
• Screw terminals	S00: 45 x 79 x 80, S0: 45 x 87 x 91, S2: 55 x 99 x 112	S00: 45 x 79 x 80, S0: 45 x 87 x 91, S2: 55 x 99 x 112	
• Spring-loaded terminals	S00: 45 x 90 x 80, S0: 45 x 109 x 92, S2: 55 x 99 x 112	S00: 45 x 90 x 80, S0: 45 x 109 x 92, S2: 55 x 99 x 112	
Current range	S00: 1.6 ... 16 A S0: 4 ... 40 A S2: 8 ... 80 A	S00: 1.6 ... 16 A S0: 4 ... 40 A S2: 8 ... 80 A	<ul style="list-style-type: none"> • Is adapted to the other devices in the SIRIUS modular system • Just a single version per size with a wide setting range enables easy configuration
Permissible ambient temperature			
During operation	-25 ... +60 °C	-25 ... +60 °C	<ul style="list-style-type: none"> • Suitable for applications in the control cabinet, worldwide

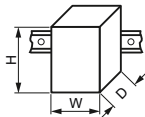

Monitoring and control devices

Relays

SIRIUS 3RR21, 3RR22 monitoring relays for mounting on 3RT2 contactors

Current and active current monitoring



Features	3RR21	3RR22	Benefits
Monitoring functions			
Current overshoot	✓ (2-phase)	✓ (3-phase)	<ul style="list-style-type: none"> Provides optimum inverse-time delayed protection of loads against excessive temperature rises due to overload Enables detection of filter blockages or pumping against closed gate valves Enables drawing conclusions about wear, poor lubrication or other maintenance-relevant phenomena
Current undershoot	✓ (2-phase)	✓ (3-phase)	<ul style="list-style-type: none"> Enables detection of underload due to a slipping or torn belt Guarantees protection of pumps against dry running Facilitates monitoring of the functions of resistive loads such as heaters Permits energy savings through monitoring of no-load operation
Apparent current monitoring	✓	✓ (Selectable)	<ul style="list-style-type: none"> Precision current monitoring especially in a motor's rated and upper torque range
Active current monitoring	--	✓ (Selectable)	<ul style="list-style-type: none"> Optimum current monitoring over a motor's entire torque range through the patented combination of power factor and apparent current monitoring
Range monitoring	✓ (2-phase)	✓ (3-phase)	<ul style="list-style-type: none"> Simultaneous monitoring of current overshoot and undershoot with a single device
Phase failure, open circuit	✓ (2-phase)	✓ (3-phase)	<ul style="list-style-type: none"> Minimizes heating of three-phase motors during phase failure through immediate disconnection Prevents operation of hoisting equipment with half the load carrying capacity
Phase sequence monitoring	--	✓ (Selectable)	<ul style="list-style-type: none"> Prevents starting of motors, pumps or compressors in the wrong direction of rotation
Internal ground fault detection (residual current monitoring)	--	✓ (Selectable)	<ul style="list-style-type: none"> Provides optimum protection of loads against high-resistance ground faults due to moisture, condensed water, damage to the insulation material, etc. Eliminates the need for additional special equipment and thus space in the control cabinet Reduces wiring overhead and costs
Blocking current monitoring	--	✓ (Selectable)	<ul style="list-style-type: none"> Minimizes heating of three-phase motors when blocked during operation through immediate disconnection Minimizes mechanical loading of the system by acting as an electronic shear pin
Features			
RESET function	✓	✓	<ul style="list-style-type: none"> Allows manual or automatic resetting of the relay Resetting directly on the device or by switching the control supply voltage off and on (remote RESET)
ON-delay time	0 ... 60 s	0 ... 99 s	<ul style="list-style-type: none"> Enables motor starting without evaluation of the starting current Can be used for monitoring motors with lengthy startup
Tripping delay time	0 ... 30 s	0 ... 30 s	<ul style="list-style-type: none"> Permits brief threshold value violations during operation Prevents frequent warnings and disconnections with currents near the threshold values
Operating and indicating elements	LEDs and rotary potentiometers	Displays and buttons	<ul style="list-style-type: none"> For setting the threshold values and delay times and for fast and targeted diagnostics For selectable functions Displays for permanent display of measured values
Integrated contacts	1 CO contact	1 CO contact, 1 semiconductor output	<ul style="list-style-type: none"> Enable disconnection of the system or process when there is an irregularity Can be used to output signals

✓ Available

-- Not available

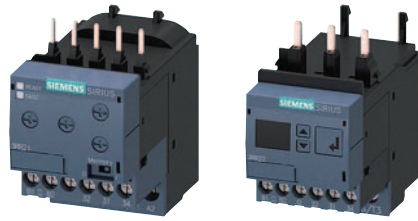

Features	3RR21	3RR22	Benefits
Design of load feeders			
Short-circuit strength up to 100 kA at 690 V (in conjunction with the corresponding fuses or the corresponding motor starter protector)	✓	✓	<ul style="list-style-type: none"> Provides optimum protection of the loads and operating personnel in the event of short circuits due to insulation faults or faulty switching operations
Electrical and mechanical matching to 3RT2 contactors	✓	✓	<ul style="list-style-type: none"> Simplifies configuration Reduces wiring overhead and costs Enables stand-alone installation as well as space-saving direct mounting
Spring-loaded terminals for main circuit (with S00, S0) and auxiliary circuits	✓ (Optional)	✓ (Optional)	<ul style="list-style-type: none"> Enable fast connections Permit vibration-resistant connections Enable maintenance-free connections
Other features			
Suitable for 1-phase and 3-phase loads	✓	✓	<ul style="list-style-type: none"> Enables the monitoring of 1-phase systems through parallel infeed at the contactor or looping the current through the three phase connections
Wide setting ranges	✓	✓	<ul style="list-style-type: none"> Reduce the number of versions Minimize the configuration overhead and costs Minimize storage overhead, storage costs, tied-up capital
Wide voltage supply range	✓ (Optional)	✓ (Optional)	<ul style="list-style-type: none"> Reduces the number of versions Minimizes the configuration overhead and costs Minimizes storage overhead, storage costs, tied-up capital

✓ Available

Possible combinations of 3RR21/3RR22 monitoring relays with 3RT2 contactors

Monitoring relays	Current range	Contactors (type, size, operating power)		
		3RT201 S00 3/4/5.5/7.5 kW	3RT202 S0 5.5/7.5/11/15/18.5 kW	3RT203 S2 18.5/22/30/37 kW
3RR2.41				
3RR2141	1.6 ... 16	✓	With stand-alone installation support	With stand-alone installation support
3RR2241	1.6 ... 16	✓	With stand-alone installation support	With stand-alone installation support
3RR2.42				
3RR2142	4 ... 40	With stand-alone installation support	✓	With stand-alone installation support
3RR2242	4 ... 40	With stand-alone installation support	✓	With stand-alone installation support
3RR2.43				
3RR2143	8 ... 80	With stand-alone installation support	With stand-alone installation support	✓
3RR2243	8 ... 80	With stand-alone installation support	With stand-alone installation support	✓

✓ Available

Monitoring and control devices

Relays

SIRIUS 3RR21, 3RR22 monitoring relays for mounting on 3RT2 contactors

Current and active current monitoring

Article number scheme

Product versions		Article number									
Monitoring relays		3RR2	<input type="checkbox"/> 4	<input type="checkbox"/> -	<input type="checkbox"/> <input type="checkbox"/> <input type="checkbox"/> <input type="checkbox"/>	3	0				
Type of setting	Analogically adjustable, 2-phase	1									
	Digitally adjustable, 3-phase	2									
Size	S00		1								
	S0		2								
	S2		3								
Connection type	Screw terminals				1						
	Spring-loaded terminals Size S00, S0				2						
	Size S2				3						
Number and type of outputs	1 CO contact					A					
	1 CO contact + 1 semiconductor					F					
Rated control supply voltage	24 V AC/DC						A				
	24 ... 240 V AC/DC						W				
Example		3RR2	1	4	1	-	1	A	A	3	0

Note:

The article number scheme shows an overview of product versions for better understanding of the logic behind the article numbers.

For your orders, please use the article numbers quoted in the selection and ordering data.

Benefits

- Can be mounted directly on 3RT2 contactors and 3RA23 reversing contactor assemblies, in other words, there is no need for additional wiring in the main circuit
- Optimally coordinated with the technical characteristics of the 3RT2 contactors
- No separate current transformer required
- Versions with wide voltage supply range
- Variably adjustable to overshoot, undershoot or range monitoring
- Freely configurable delay times and RESET response
- Display of actual value and status messages
- All versions with removable control current terminals
- All versions with screw terminals or spring-loaded terminals
- Simple determination of the threshold values through direct reference to actually measured values for setpoint loading
- Range monitoring and selectable active current measurement mean that only one device for monitoring a motor is required along the entire torque curve.
- In addition to current monitoring it is also possible to monitor for broken cables, phase failure, phase sequence, residual current and motor blocking

Application

- Monitoring for current overshoot and undershoot
- Monitoring of broken conductors
- Monitoring of no-load operation and load shedding, e.g. in the event of a torn V-belt or no-load operation of a pump
- Monitoring of overload, e.g. on conveyor belts or cranes due to an excessive load
- Monitoring the functionality of electrical loads such as heaters
- Monitoring of wrong phase sequence on mobile equipment such as compressors or cranes
- Monitoring of high-resistance short circuits or ground faults, e.g. caused by damaged insulation or moisture

Technical specifications

More information

Technical specifications, see <https://support.industry.siemens.com/cs/ww/en/ps/16205/td>
 Digital Configuration Manual for load feeders, see <https://imp.siemens.com/digital-engineering-manual/dem>
 Configuration Manual for load feeders, see <https://support.industry.siemens.com/cs/ww/en/view/39714188>

Equipment Manual, see <https://support.industry.siemens.com/cs/ww/en/view/54397927>
 FAQs, see <https://support.industry.siemens.com/cs/ww/en/ps/16205/faq>

Function diagrams of 3RR214.-A.30 Basic versions, analogically adjustable

Closed-circuit principle upon application of the control supply voltage

Current overshoot

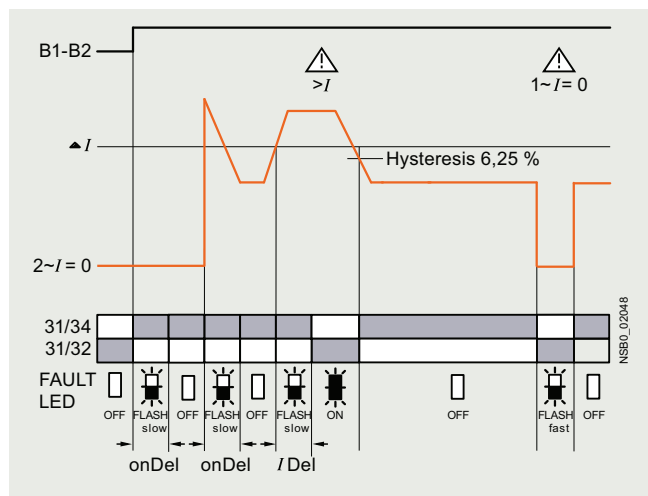

Range monitoring

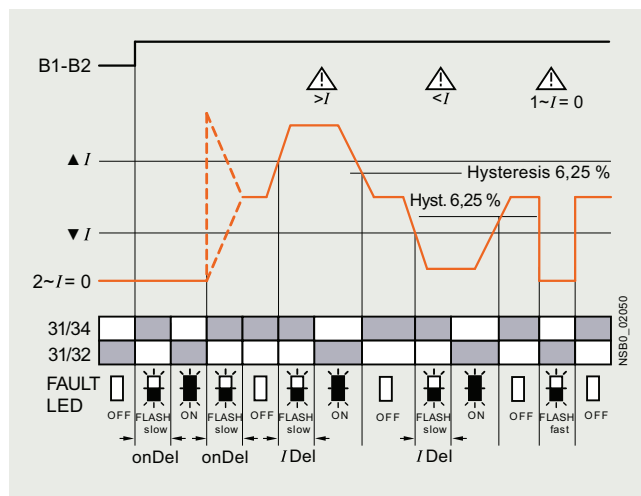

Current undershoot

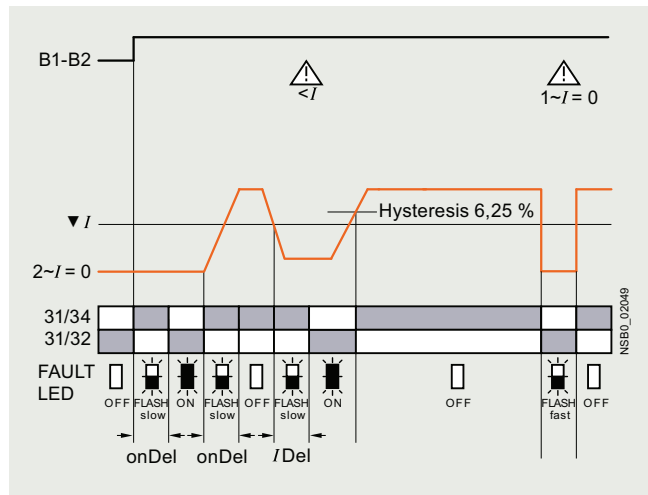

Monitoring and control devices

Relays

SIRIUS 3RR21, 3RR22 monitoring relays for mounting on 3RT2 contactors

Current and active current monitoring

Function diagrams of 3RR224.-F.30 standard versions, digitally adjustable

With the closed-circuit principle selected upon application of the control supply voltage

Current overshoot

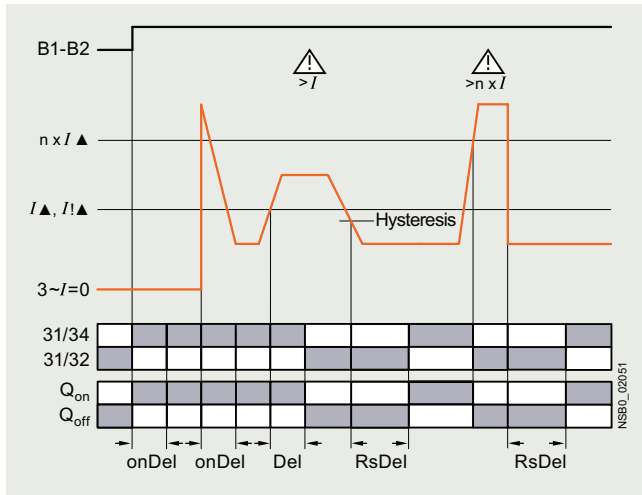

Range monitoring

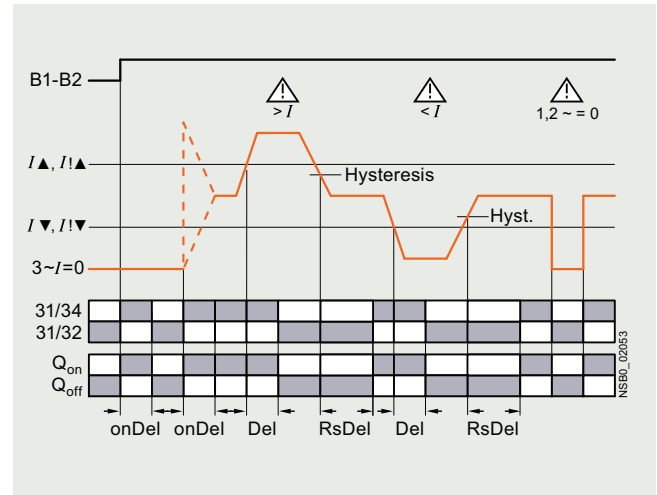

Current undershoot with residual current monitoring

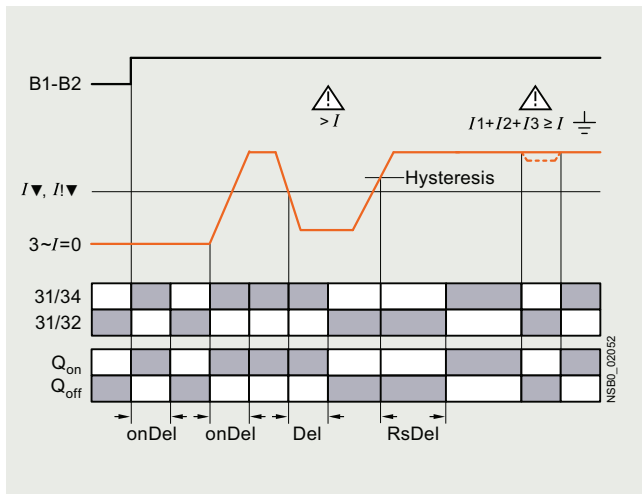

Phase sequence monitoring

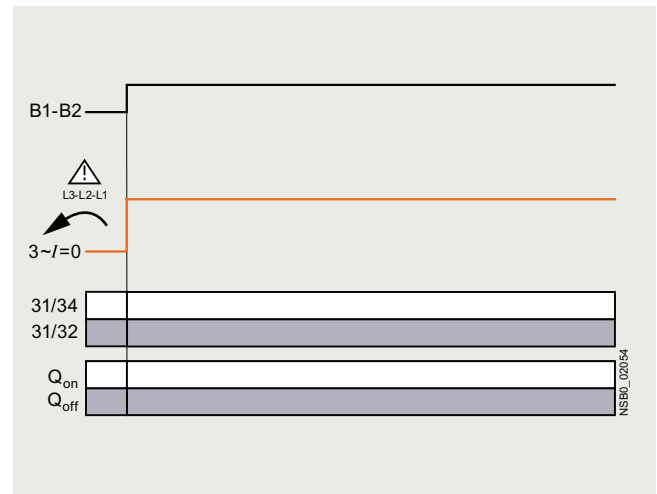

Selection and ordering data

PU (UNIT, SET, M) = 1
 PS* = 1 unit
 PG = 41H



3RR2141-1AW30



3RR2142-1AW30



3RR2241-1FW30





3RR2242-2FW30



3RR2141-2AA30



3RR2243-3FW30

Size	Measuring range	Hysteresis	Supply voltage U_s	Screw terminals 	Spring-loaded terminals 
A	A	A	V	Article No.	Price per PU
Article No.	Price per PU	Article No.	Price per PU		
Basic versions					
<ul style="list-style-type: none"> Analogically adjustable Closed-circuit principle 1 CO contact 2-phase current monitoring Apparent current monitoring ON-delay 0 ... 60 s Tripping delay 0 ... 30 s 					
S00	1.6 ... 16	6.25% of threshold value	24 AC/DC 24 ... 240 AC/DC	3RR2141-1AA30 3RR2141-1AW30	3RR2141-2AA30 3RR2141-2AW30
S0	4 ... 40	6.25% of threshold value	24 AC/DC 24 ... 240 AC/DC	3RR2142-1AA30 3RR2142-1AW30	3RR2142-2AA30 3RR2142-2AW30
S2	8 ... 80	6.25% of threshold value	24 AC/DC 24 ... 240 AC/DC	3RR2143-1AA30 3RR2143-1AW30	3RR2143-3AA30 3RR2143-3AW30
Standard versions					
<ul style="list-style-type: none"> Digitally adjustable LC display Open-circuit or closed-circuit principle 1 CO, 1 semiconductor output 3-phase current monitoring Active current or apparent current monitoring Phase sequence monitoring Residual current monitoring Blocking current monitoring Reclosing delay time 0 ... 300 min ON-delay 0 ... 99 s Separate settings for warning and alarm thresholds Tripping delay 0 ... 30 s 					
S00	1.6 ... 16	0.1 ... 3	24 AC/DC 24 ... 240 AC/DC	3RR2241-1FA30 3RR2241-1FW30	3RR2241-2FA30 3RR2241-2FW30
S0	4 ... 40	0.1 ... 8	24 AC/DC 24 ... 240 AC/DC	3RR2242-1FA30 3RR2242-1FW30	3RR2242-2FA30 3RR2242-2FW30
S2	8 ... 80	0.2 ... 16	24 AC/DC 24 ... 240 AC/DC	3RR2243-1FA30 3RR2243-1FW30	3RR2243-3FA30 3RR2243-3FW30

Monitoring and control devices

Relays

SIRIUS 3RR21, 3RR22 monitoring relays for mounting on 3RT2 contactors

Current and active current monitoring

Accessories

Use	Version	Size	Article No.	Price per PU	PU (UNIT, SET, M)	PS*	PG
Terminal supports for stand-alone installation¹⁾							
 3RU2916-3AA01	For 3RR21, 3RR22 For separate mounting of the overload relays or monitoring relays; screw and snap-on mounting on TH 35 DIN rail according to IEC 60715 <ul style="list-style-type: none"> Screw terminals 	S00	Screw terminals  3RU2916-3AA01 3RU2926-3AA01 3RU2936-3AA01		1	1 unit	41F
		S0			1	1 unit	41F
		S2			1	1 unit	41F
 3RU2936-3AA01	<ul style="list-style-type: none"> Spring-loaded terminals 	S00	Spring-loaded terminals  3RU2916-3AC01 3RU2926-3AC01		1	1 unit	41F
		S0			1	1 unit	41F
 3RU2926-3AC01							
Sealable covers							
 3RR2940	For 3RR21, 3RR22 Sealable covers For securing against unintentional or unauthorized adjustment of settings		3RR2940		1	5 units	41H
Blank labels							
 3RT2900-1SB20	For 3RR21, 3RR22 Unit labeling plates²⁾ For SIRIUS devices <ul style="list-style-type: none"> 20 mm x 7 mm, titanium gray 		3RT2900-1SB20		100	340 units	41B
Tools for opening spring-loaded terminals							
 3RA2908-1A	For auxiliary circuit connections Screwdrivers For all SIRIUS devices with spring-loaded terminals Length approx. 200 mm, 3,0 mm x 0.5 mm, titanium gray/black, partially insulated		Spring-loaded terminals  3RA2908-1A		1	1 unit	41B

¹⁾ The accessories are exactly the same as the accessories for the 3RU2 thermal overload relay and the 3RB3 electronic overload relay, see page 7/104 onwards.

²⁾ PC labeling system for individual inscription of unit labeling plates available from: murrplastik Systemtechnik GmbH, see page 16/18.

Overview

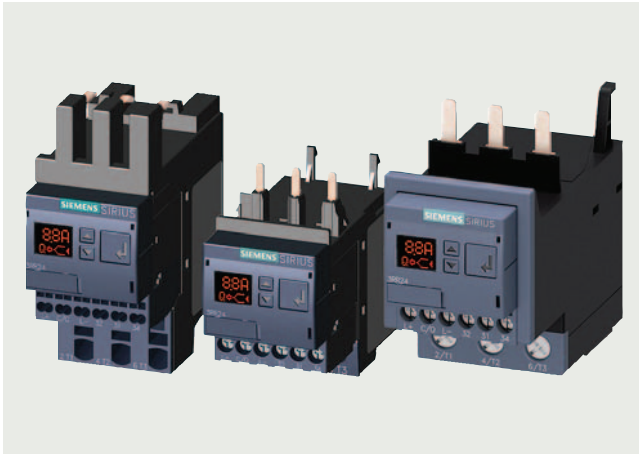

SIRIUS 3RR2441, 3RR2442 and 3RR2443 current monitoring relays

More information

Homepage, see www.siemens.com/sirius-monitoring-relays
 SiePortal, see www.siemens.com/product_catalog_siep?3RR24



Video: SIRIUS 3RR2 current monitoring relays

The SIRIUS 3RR24 current monitoring relays for IO-Link are suitable for the load monitoring of motors or other loads. In 3 phases they monitor the rms value of AC currents for overshooting or undershooting of set threshold values.

Whereas apparent current monitoring is used above all in connection with the rated torque or in case of overload, the active current monitoring option, which is also selectable, can be used to observe and evaluate the load factor over a motor's entire torque range.

The 3RR24 current monitoring relays for IO-Link can be integrated directly in the feeder by mounting on the 3RT2 contactor; separate wiring of the main circuit is therefore superfluous. No separate transformers are required.

For a line-oriented configuration or simultaneous use of an overload relay, terminal supports for stand-alone installation are available for separate DIN-rail mounting.

The SIRIUS 3RR24 current monitoring relays for IO-Link also offer many other options based upon the monitoring functions of the conventional SIRIUS 3RR2 monitoring relays:

- Measured value transmission to a controller, including resolution and unit, may be configurable as to which value is cyclically transmitted
- Transmission of alarm flags to a controller
- Full diagnostics capability by inquiry as to the cause of the fault in the diagnostics data record
- Remote parameterization is also possible, in addition to or instead of local parameterization

- Rapid parameterization of the same devices by duplication of the parameterization in the controller
- Parameter transmission through upload to a controller by IO-Link call or via parameter server (if IO-Link master with IO-Link specification V1.1 or higher is used)
- Consistent central data storage in the event of parameter change locally or via a controller
- Automatic reparameterizing when devices are exchanged
- Blocking of local parameterization via IO-Link possible
- Faults are saved in a configurable and non-volatile fashion to prevent an automatic startup after voltage failure and to make sure diagnostics data are not lost
- Integration into the automation level provides the option of parameterizing the monitoring relays at any time via a display unit, or displaying the measured values in a control room or locally at the machine/control cabinet.

Even without communication via IO-Link the devices continue to function fully autonomously:

- Parameterization can take place locally at the device, independently of a controller.
- In the event of failure or before the controller becomes available the monitoring relays work as long as the control supply voltage (24 V DC) is present.
- If the monitoring relays are operated without the controller, the 3RR24 monitoring relays for IO-Link have, thanks to the integrated SIO mode, an additional semiconductor output, which switches when the adjustable warning threshold is exceeded.

Thanks to the combination of autonomous monitoring relay function and integrated IO-Link communication, redundant sensors and/or analog signal converters – which previously took over the transmission of measured values to a controller, leading to considerable extra cost and wiring overhead – are no longer needed.

Because the output relays are still present, the monitoring relays increase the functional reliability of the system, since only the controller can fulfill the control tasks if the current measured values are available, whereas the output relays can also be used for the disconnection of the system if limit values that cannot be reached during operation are exceeded.

For more information on the IO-Link communications system, see [page 2/83 onwards](#).

Notes on security

In order to protect plants, systems, machines and networks against cyber threats, it is necessary to implement – and continuously maintain – a holistic, state-of-the-art industrial cybersecurity concept. Siemens products and solutions represent one component of such a concept.

For more information on industrial cybersecurity, see www.siemens.com/cybersecurity-industry.

Monitoring and control devices

Relays

SIRIUS 3RR24 monitoring relays for mounting on 3RT2 contactors for IO-Link

Current and active current monitoring

3RR24 overview table



Features	3RR24	Benefits
General data		
Sizes		
Dimensions in mm (W x H x D)		<ul style="list-style-type: none"> • Are coordinated with the dimensions, connections and technical characteristics of the other devices in the SIRIUS modular system (contactors, soft starters, etc.) • Permit the mounting of slim-line and compact load feeders in widths of 45 mm (S00 and S0) and 55 mm (S2) • Simplify configuration
• Screw terminals		
• Spring-loaded terminals	S00: 45 x 90 x 80, S0: 45 x 109 x 92, S2: 55 x 99 x 112	
Current range		
	S00: 1.6 ... 16 A S0: 4 ... 40 A S2: 8 ... 80 A	<ul style="list-style-type: none"> • Is adapted to the other devices in the SIRIUS modular system • Just a single version per size with a wide setting range enables easy configuration
Permissible ambient temperature		
During operation	-25 ... +60 °C	<ul style="list-style-type: none"> • Suitable for applications in the control cabinet, worldwide
Monitoring functions		
Current overshoot		
	✓ (3-phase)	<ul style="list-style-type: none"> • Provides optimum inverse-time delayed protection of loads against excessive temperature rises due to overload • Enables detection of filter blockages or pumping against closed gate valves • Enables drawing conclusions about wear, poor lubrication or other maintenance-relevant phenomena
Current undershoot		
	✓ (3-phase)	<ul style="list-style-type: none"> • Enables detection of underload due to a slipping or torn belt • Guarantees protection of pumps against dry running • Facilitates monitoring of the functions of resistive loads such as heaters • Permits energy savings through monitoring of no-load operation
Apparent current monitoring		
	✓ (Selectable)	<ul style="list-style-type: none"> • Precision current monitoring especially in a motor's rated and upper torque range
Active current monitoring		
	✓ (Selectable)	<ul style="list-style-type: none"> • Optimum current monitoring over a motor's entire torque range through the patented combination of power factor and apparent current monitoring
Range monitoring		
	✓ (3-phase)	<ul style="list-style-type: none"> • Simultaneous monitoring of current overshoot and undershoot with a single device
Phase failure, open circuit		
	✓ (3-phase)	<ul style="list-style-type: none"> • Minimizes heating of three-phase motors during phase failure through immediate disconnection • Prevents operation of hoisting equipment with half the load carrying capacity
Phase sequence monitoring		
	✓ (Selectable)	<ul style="list-style-type: none"> • Prevents starting of motors, pumps or compressors in the wrong direction of rotation
Internal ground fault detection (residual current monitoring)		
	✓ (Selectable)	<ul style="list-style-type: none"> • Provides optimum protection of loads against high-resistance ground faults due to moisture, condensed water, damage to the insulation material, etc. • Eliminates the need for additional special equipment • Saves space in the control cabinet • Reduces wiring overhead and costs
Blocking current monitoring		
	✓ (Selectable)	<ul style="list-style-type: none"> • Minimizes heating of three-phase motors when blocked during operation through immediate disconnection • Minimizes mechanical loading of the system by acting as an electronic shear pin
Operating hours counter		
	✓	<ul style="list-style-type: none"> • Gives the time during which there was a measurable current in at least 2 conducting paths • As an indicator for upcoming preventive maintenance or replacement of machine and system components
Operating cycles counter		
	✓	<ul style="list-style-type: none"> • Is incremented by 1 each time a breaking operation is detected, in other words a transition from 3-phase current flow to no measurable current flow • As an indicator for upcoming preventive maintenance or replacement of contact blocks

✓ Available



Features	3RR24	Benefits
Features		
RESET function	✓	<ul style="list-style-type: none"> Allows manual or automatic resetting of the relay Resetting directly on the device, by switching the control supply voltage off and on or via IO-Link (remote RESET)
ON-delay time	0 ... 999.9 s	<ul style="list-style-type: none"> Enables motor starting without evaluation of the starting current Can be used for monitoring motors with lengthy startup
Tripping delay time	0 ... 999.9 s	<ul style="list-style-type: none"> Permits brief threshold value violations during operation Prevents frequent warnings and disconnections with currents near the threshold values
Operating and indicating elements	Displays and buttons	<ul style="list-style-type: none"> For setting the threshold values and delay times For selectable functions For quick and selective diagnostics Displays for permanent display of measured values
Integrated contacts	1 CO contact, 1 semiconductor output (in SIO mode)	<ul style="list-style-type: none"> Enable disconnection of the system or process when there is an irregularity Can be used to output signals
Design of load feeders		
Short-circuit strength up to 100 kA at 690 V (in conjunction with the corresponding fuses or the corresponding motor starter protector)	✓	<ul style="list-style-type: none"> Provides optimum protection of the loads and operating personnel in the event of short circuits due to insulation faults or faulty switching operations
Electrical and mechanical matching to 3RT2 contactors	✓	<ul style="list-style-type: none"> Simplifies configuration Reduces wiring overhead and costs Enables stand-alone installation as well as space-saving direct mounting
Spring-loaded terminals for main circuit (with S00, S0) and auxiliary circuits	✓ (Optional)	<ul style="list-style-type: none"> Enable fast connections Permit vibration-resistant connections Enable maintenance-free connections
Other features		
Suitable for 1-phase and 3-phase loads	✓	<ul style="list-style-type: none"> Enables the monitoring of 1-phase systems through parallel infeed at the contactor or looping the current through the three phase connections
Wide setting ranges	✓	<ul style="list-style-type: none"> Reduce the number of versions Minimize the configuration overhead and costs Minimize storage overhead, storage costs, tied-up capital
Power supply	24 V DC	<ul style="list-style-type: none"> Direct via IO-Link master or via an external auxiliary voltage independent of the IO-Link Minimizes the configuration overhead and costs

✓ Available

Possible ways of combining the 3RR24 monitoring relay with the 3RT2 contactor for IO-Link

Monitoring relays	Current range	Contactors (type, size, operating power)		
		3RT201 S00 3/4/5.5/7.5 kW	3RT202 S0 5.5/7.5/11/15/18.5 kW	3RT203 S2 18.5/22/30/37 kW
3RR2441	1.6 ... 16	✓	With stand-alone installation support	With stand-alone installation support
3RR2442	4 ... 40	With stand-alone installation support	✓	With stand-alone installation support
3RR2443	8 ... 80	With stand-alone installation support	With stand-alone installation support	✓

✓ Available

Notes:

Devices required for communication via IO-Link:

- Any controller that supports IO-Link (e.g. ET 200SP with CPU or S7-1200), see [Catalog ST 70](#).
- IO-Link master (e.g. CM 4xIO-Link for SIMATIC ET 200SP, see [page 2/94](#) or SM 1278 for S7-1200, see [page 2/93](#)).

Each monitoring relay requires an IO-Link channel.

Monitoring and control devices

Relays

SIRIUS 3RR24 monitoring relays for mounting on 3RT2 contactors for IO-Link

Current and active current monitoring

Article number scheme

Product versions		Article number	
3RR24 monitoring relay, digitally adjustable with IO-Link		3RR2 4 4 □ - □ A A 4 0	
Size	S00	1	
	S0	2	
	S2	3	
Connection type	Screw terminals		1
	Spring-loaded terminals		
	• Size S00, S0 • Size S2		2 3
Example		3RR2 4 4 1 - 1 A A 4 0	

Note:

The article number scheme shows an overview of product versions for better understanding of the logic behind the article numbers.

For your orders, please use the article numbers quoted in the selection and ordering data.

Benefits

- Can be mounted directly on 3RT2 contactors and 3RA23 reversing contactor assemblies, in other words, there is no need for additional wiring in the main circuit
- Optimally coordinated with the technical characteristics of the 3RT2 contactors
- No separate current transformer required
- Variably adjustable to overshoot, undershoot or range monitoring
- Freely configurable delay times and RESET response
- Display of actual value and status messages
- All versions with removable control current terminals
- All versions with screw or spring-loaded terminals
- Simple determination of the threshold values through direct reference to actually measured values for setpoint loading
- Range monitoring and selectable active current measurement mean that only one device for monitoring a motor is required along the entire torque curve.
- In addition to current monitoring it is also possible to monitor for current asymmetry, broken cables, phase failure, phase sequence, residual current and motor blocking.
- Integrated counter for operating cycles and operating hours to support requirements-based preventive maintenance of the monitored machine or application
- Simple cyclical transmission of the current measured values, relay switching states and events to a controller
- Remote parameterization
- Automatic reparameterizing when devices are exchanged
- Simple duplication of identical or similar parameterizations
- Reduction of control current wiring
- Elimination of testing costs and wiring errors
- Reduction of configuration work
- Integration in TIA means clear diagnostics if a fault occurs
- Cost saving and space saving in control cabinet due to the elimination of AI and IO modules as well as analog signal converters and duplicated sensors

Application

- Monitoring for current overshoot and undershoot
- Monitoring of broken conductors
- Monitoring of no-load operation and load shedding, e.g. in the event of a torn V-belt or no-load operation of a pump
- Monitoring of overload, e.g. on pumps due to a dirty filter system
- Monitoring the functionality of electrical loads such as heaters
- Monitoring of wrong phase sequence on mobile equipment such as compressors or cranes
- Monitoring of high-resistance short circuits or ground faults, e.g. caused by damaged insulation or moisture

The use of SIRIUS monitoring relays for IO-Link is particularly recommended for machines and plants in which these relays, in addition to their monitoring function, are to be connected to the automation level for the rapid, simple and fault-free provision of the current measured values and/or for remote parameterization.

The monitoring relays can either relieve the controller of monitoring tasks or, as a second monitoring entity in parallel to and independent of the controller, increase the reliability in the process or in the system. In addition, the elimination of AI and IO modules allows the width of the controller to be reduced despite significantly expanded functionality.

Technical specifications

More information

Technical specifications, see <https://support.industry.siemens.com/cs/ww/en/ps/16206/td>
 Digital Configuration Manual for load feeders, see <https://imp.siemens.com/digital-engineering-manual/dem>
 Configuration Manual for load feeders, see <https://support.industry.siemens.com/cs/ww/en/view/39714188>

Equipment Manual, see <https://support.industry.siemens.com/cs/ww/en/view/54375430>
 FAQs, see <https://support.industry.siemens.com/cs/ww/en/ps/16206/faq>

Function diagrams of 3RR24 for IO-Link, digitally adjustable

With the closed-circuit principle selected upon application of the control supply voltage

Current overshoot

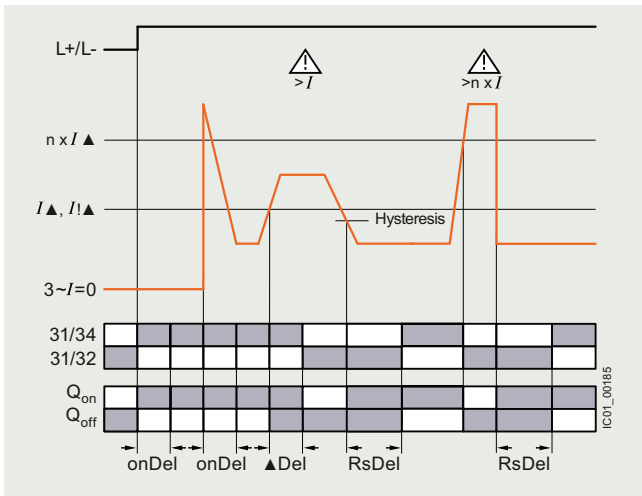

Range monitoring

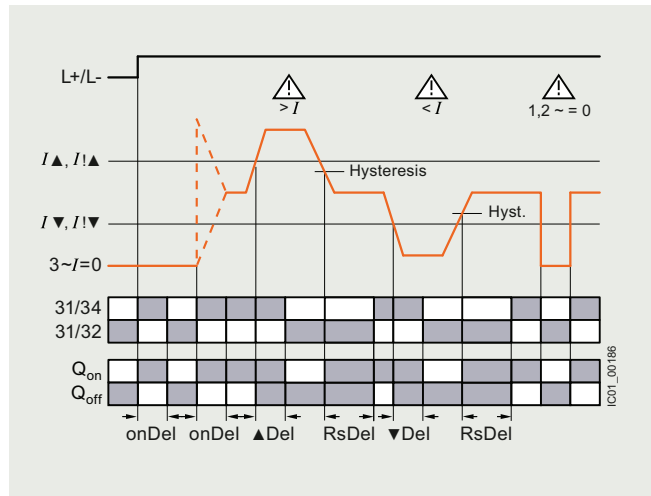

Current undershoot with residual current monitoring

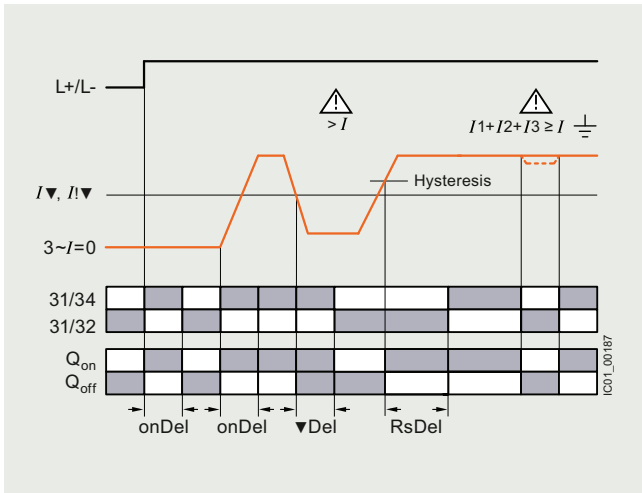

Phase sequence monitoring

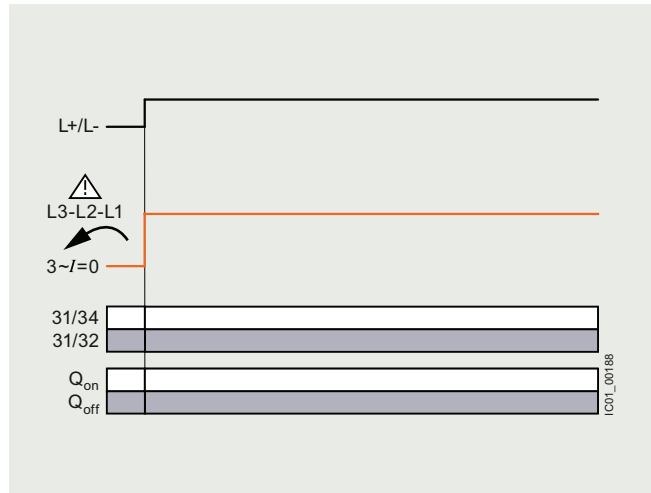

Monitoring and control devices

Relays

SIRIUS 3RR24 monitoring relays for mounting on 3RT2 contactors for IO-Link

Current and active current monitoring

Selection and ordering data

SIRIUS 3RR24 current monitoring relays for IO-Link

PU (UNIT, SET, M) = 1
 PS* = 1 unit
 PG = 41H



3RR2441-1AA40

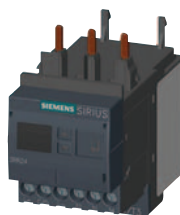

3RR2442-1AA40



3RR2441-2AA40





3RR2442-2AA40



3RR2443-1AA40



3RR2443-3AA40

Size	Measuring range	Hysteresis	Supply voltage U_s	Screw terminals 		Spring-loaded terminals 	
				Article No.	Price per PU	Article No.	Price per PU
A	A	A	V				
<ul style="list-style-type: none"> Digitally adjustable LC display Open-circuit or closed-circuit principle 1 CO 1 semiconductor output (in SIO mode) 3-phase current monitoring Active current or apparent current monitoring Current asymmetry monitoring Phase sequence monitoring Residual current monitoring Blocking current monitoring Operating hours counter Operating cycles counter Reclosing delay time 0 ... 300 min ON-delay 0 ... 999.9 s Tripping delay 0 ... 999.9 s Separate settings for warning and alarm thresholds Automatic or manual RESET 							
S00	1.6 ... 16	0.1 ... 3	24 DC	3RR2441-1AA40		3RR2441-2AA40	
S0	4 ... 40	0.1 ... 8	24 DC	3RR2442-1AA40		3RR2442-2AA40	
S2	8 ... 80	0.2 ... 16	24 DC	3RR2443-1AA40		3RR2443-3AA40	

Accessories

Use	Version	Size	Article No.	Price per PU	PU (UNIT, SET, M)	PS*	PG					
Terminal supports for stand-alone installation¹⁾												
 3RU2916-3AA01	For 3RR24	For separate mounting of the overload relays or monitoring relays; screw and snap-on mounting on TH 35 DIN rail according to IEC 60715 <ul style="list-style-type: none"> Screw terminals 	Screw terminals 									
								S00	3RU2916-3AA01	1	1 unit	41F
								S0	3RU2926-3AA01	1	1 unit	41F
		S2	3RU2936-3AA01	1	1 unit	41F						
 3RU2936-3AA01	For 3RR24	For separate mounting of the overload relays or monitoring relays; screw and snap-on mounting on TH 35 DIN rail according to IEC 60715 <ul style="list-style-type: none"> Screw terminals 	Screw terminals 									
								S00	3RU2916-3AC01	1	1 unit	41F
		S0	3RU2926-3AC01	1	1 unit	41F						
 3RU2926-3AC01	For 3RR24	For separate mounting of the overload relays or monitoring relays; screw and snap-on mounting on TH 35 DIN rail according to IEC 60715 <ul style="list-style-type: none"> Spring-loaded terminals 	Spring-loaded terminals 									
								S00	3RU2916-3AC01	1	1 unit	41F
		S0	3RU2926-3AC01	1	1 unit	41F						
Sealable covers												
 3RR2940	For 3RR24	Sealable covers For securing against unintentional or unauthorized adjustment of settings	3RR2940		1	5 units	41H					
Blank labels												
 3RT2900-1SB20	For 3RR24	Unit labeling plates²⁾ For SIRIUS devices <ul style="list-style-type: none"> 20 mm x 7 mm, titanium gray 	3RT2900-1SB20		100	340 units	41B					
Tools for opening spring-loaded terminals												
 3RA2908-1A	For auxiliary circuit connections	Screwdriver For all SIRIUS devices with spring-loaded terminals <ul style="list-style-type: none"> Length approx. 200 mm, 3.0 mm x 0.5 mm, titanium gray/black, partially insulated 	Spring-loaded terminals 		1	1 unit	41B					
			3RA2908-1A									

¹⁾ The accessories are exactly the same as the accessories for the 3RU2 thermal overload relay and the 3RB3 electronic overload relay, see page 7/104 onwards.

²⁾ PC labeling system for individual inscription of unit labeling plates available from: murrplastik Systemtechnik GmbH, see page 16/18.

Monitoring and control devices

Relays

SIRIUS 3UG5 monitoring relays for stand-alone installation

General data

Overview



SIRIUS 3UG5 monitoring relays

More information

Homepage, see www.siemens.com/sirius-monitoring-relays
 SiePortal, see www.siemens.com/product_catalog_siep?3UG5
 TIA Selection Tool Cloud (TST Cloud), see www.siemens.com/tstcloud/?node=SIRIUSRelais
 Conversion tool, see www.siemens.com/conversion-tool

The SIRIUS 3UG5 monitoring relays for electrical and mechanical quantities enable constant monitoring of all important characteristic quantities that provide information about the reliability performance of the plant. Both sudden disturbances and gradual changes, which may indicate the need for maintenance, are detected. Thanks to their relay outputs, the monitoring relays permit direct disconnection of the affected system components as well as alerting (e.g. by switching a warning lamp).

Thanks to adjustable delay times the monitoring relays can respond very flexibly to brief faults such as voltage dips or load changes. This avoids unnecessary alarms and disconnections while enhancing plant availability.

The individual 3UG5 monitoring relays offer the following functions in various combinations:

- Undershooting and/or overshooting of limit values for voltage for 1-phase monitoring
- Undershooting and/or overshooting of the frequency
- Power monitoring
- Undershooting and/or overshooting of limit values for current
- Undershooting and/or overshooting of power factor limit values
- Monitoring of the active current or the apparent current
- Monitoring of the residual current
- Undershooting and/or overshooting of the liquid level
- Undershooting and/or overshooting of limit values for speed

The device family comprises devices with fixed function, analogically adjustable and digitally adjustable devices that can be parameterized using an intuitive LC display. There are further variants with Bluetooth, a Safety version or IO-Link.

Note:

The SIRIUS 3UG5 relays supersede the predecessor 3UG4. Exception: 3UG4 insulation monitoring relays, see page 10/111.

Devices with fixed function or analogically adjustable devices



SIRIUS 3UG5512 and 3UG5514 monitoring relays

In addition to devices with a fixed function, such as 3UG5511 and 3UG5512, there are analogically adjustable devices, such as 3UG5514, whose parameters are set using potentiometers.

Digitally adjustable devices



SIRIUS 3UG5616 monitoring relay

Using the display, the digitally adjustable relays, such as SIRIUS 3UG5616 or 3UG5618, can be simply and intuitively parameterized via a menu and four buttons.

Devices with Bluetooth

Parameter assignment via Bluetooth with SENTRON Powerconfig app

The 3UG5716 and 3UG5742 relays can also be supplied with Bluetooth. They can be easily parameterized using a smartphone with the SENTRON Powerconfig app. This provides a clearer way of setting the parameters. It is also possible to transfer parameter assignments already made to several devices.

Devices in the Safety version

Selected devices are available with Safety certification up to SIL 1/PL c according to IEC 62061 or ISO 13849.

Digitally adjustable devices for IO-Link

SIRIUS 3UG5816 monitoring relays for IO-Link

Most monitoring relays are available as versions for IO-Link. This enables simple connection to the controller and use of the measured values of the devices, for example, for maintenance.

Notes:

The IO-Link devices can be reset on the display or via IO-Link.

More information on IO-Link, see [page 2/83 onwards](#).

Monitoring and control devices

Relays

SIRIUS 3UG5 monitoring relays for stand-alone installation

General data

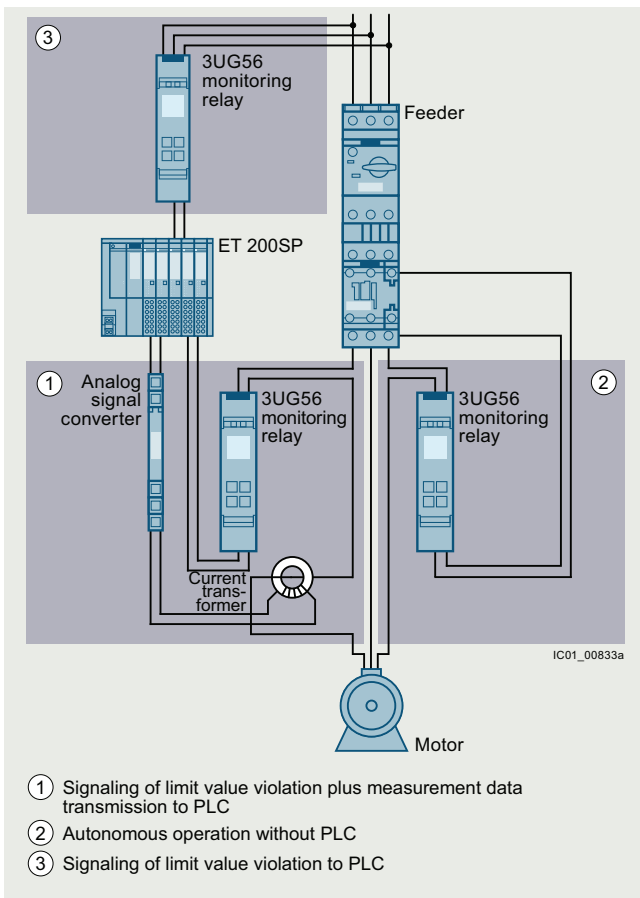

Use of conventional monitoring relays

Notes:

Devices required for communication via IO-Link:

- Any controller that supports IO-Link (e.g. ET 200SP with CPU or S7-1200), see [Catalog ST 70](#).
- IO-Link master (e.g. CM 4xIO-Link for SIMATIC ET 200SP, see [page 2/94](#) or SM 1278 for S7-1200, see [page 2/93](#)).

Each monitoring relay requires an IO-Link channel.

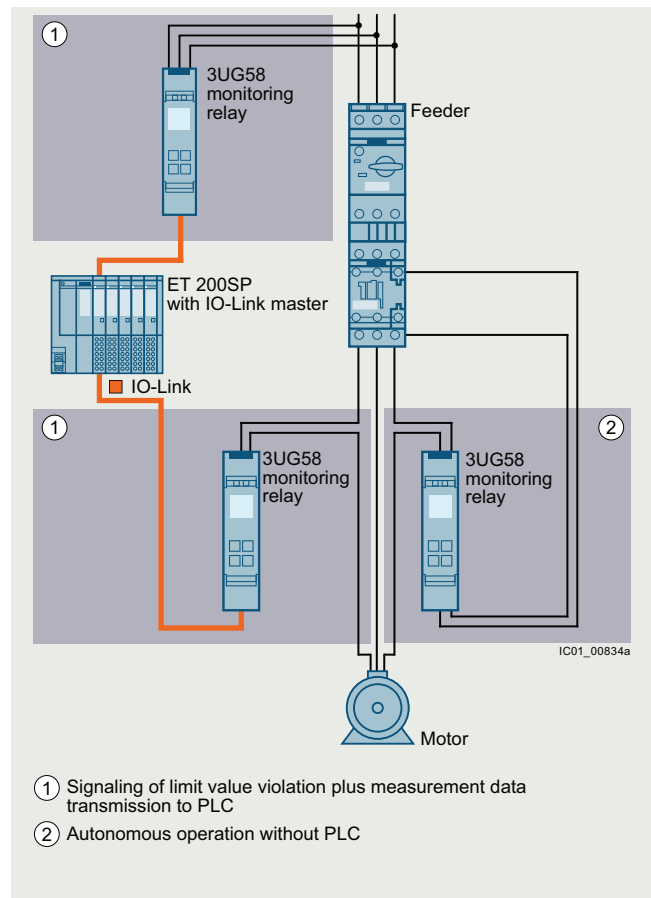

Use of monitoring relays for IO-Link

Notes on security:

In order to protect plants, systems, machines and networks against cyber threats, it is necessary to implement – and continuously maintain – a holistic, state-of-the-art industrial cybersecurity concept. Siemens products and solutions represent one component of such a concept.

For more information on industrial cybersecurity, see www.siemens.com/cybersecurity-industry.

Article number scheme

Product versions	Article number
Monitoring relays	3UG5 □ □ □ – □ □ □ □ 0
Type of setting	e.g. 5 = digitally adjustable □
Functions	e.g. 33 = voltage monitoring □ □
Connection type	Screw terminals 1
	Spring-loaded terminals (push-in) 2
Contacts	e.g. A = 1 CO contact □
Supply voltage	e.g. L3 = 24 ... 240 V AC/DC □ □
Example	3UG5 5 3 3 – 1 A L 3 0

Note:

The article number scheme shows an overview of product versions for better understanding of the logic behind the article numbers.

For your orders, please use the article numbers quoted in the selection and ordering data.

Benefits

- Configurable monitoring functions, delay times, RESET response, etc.
- Versions for IO-Link and Bluetooth
- Safety versions
- Reduced stock-keeping thanks to minimized variance and large measuring ranges
- Wide-voltage power supply units for global applicability
- Reliable system diagnostics thanks to actual value display and connectable fault storage
- Fast commissioning thanks to menu-guided parameterization and actual value display for limit value determination
- Reduced space requirement in the control cabinet thanks to a consistent width of 22.5 mm
- Customary screw and spring-loaded terminals (push-in) for quick and reliable wiring
- Device replacement without renewed wiring thanks to removable terminals

Application

The SIRIUS 3UG5 monitoring relays monitor the most diverse electrical and mechanical quantities in the feeder, and provide reliable protection against damage in the plant. For this purpose, they offer freely configurable limit values and diverse options for adapting to the respective task, and in the event of a fault, they provide clear diagnostics information.

The digitally adjustable products also display the current measured values directly on the device. This not only facilitates the display of valuable plant status information during operation, it also enables adjustment of the monitored limit values in accordance with the actual conditions.

The positive result: More selective avoidance of production faults – sustained increases in availability and productivity.

The 3UG5 monitoring relays are available for the following applications:

- Line monitoring
- 1-phase voltage monitoring
- 1-phase current monitoring or power factor and active current monitoring
- Load monitoring
- Residual current monitoring
- Level monitoring
- Speed monitoring

Selected devices are approved for applications up to SIL 1 according to IEC 62061 or PL c according to ISO 13849-1.

Monitoring and control devices

Relays

SIRIUS 3UG5 monitoring relays for stand-alone installation

Line monitoring

Overview



SIRIUS 3UG5 line monitoring relays



Video: SIRIUS 3UG5 line monitoring

Electronic line monitoring relays provide maximum protection for mobile machines and plants or for unstable networks. Network and voltage faults can thus be detected early and rectified before far greater damage ensues.

The device family comprises devices with fixed or analogically adjustable functions and digitally adjustable devices that can be parameterized using an intuitive LC display. The 3UG5816 device is available as a version for IO-Link. The 3UG5716 relay is digitally adjustable with Bluetooth. It can be parameterized via a menu and four buttons or via the Powerconfig app.

Application	Line monitoring relay							
	3UG5 511	3UG5 512	3UG5 514	3UG5 616	3UG5 618	3UG5 716	3UG5 816	
Phase sequence	✓							
Phase failure	--	✓						
Phase asymmetry	--	✓ (fixed)	✓					
Undervoltage	--		✓					
Overvoltage	--			✓				
Frequency	--			✓				
N conductor failure	--		✓					
Correction of the direction of rotation	--				✓	--		
SIL 1/PL c	--	✓	--		✓	--		
IO-Link	--						✓	
Bluetooth	--				--	✓	--	

✓ Available

-- Not available

Depending on the version, the relays monitor phase sequence, phase failure with and without N conductor monitoring, phase asymmetry, frequency, undervoltage or overvoltage.

Phase asymmetry is evaluated as the difference between the greatest and the smallest phase voltage relative to the greatest phase voltage. Undervoltage or overvoltage exists when at least one phase voltage deviates by 20% from the set rated line voltage or the directly set limit values are overshoot or undershot. The rms value of the voltage is measured.

With the SIRIUS 3UG5618 line monitoring relay, a wrong direction of rotation can be corrected automatically.

The 3UG5512 and 3UG5618 devices are also available as versions with Safety certification up to SIL 1/PL c according to IEC 62061 or ISO 13849.

The 3UG5511 and 3UG5512 devices have a fixed function. The 3UG5514 relays can be parameterized using a potentiometer.

Benefits

- Can be used without auxiliary voltage in any network from 160 to 690 V AC worldwide thanks to wide voltage range
- Variably adjustable to overshoot, undershoot or range monitoring
- Freely configurable delay times and RESET response
- Width 22.5 mm
- Reduced stock-keeping and logistics thanks to heavily reduced device variance
- Permanent display of actual value and power system fault type in case of digital versions
- Automatic correction of the direction of rotation by distinguishing between power system faults and wrong phase sequence
- Devices with frequency monitoring
- Devices with Safety certification according to SIL 1/PL c
- Devices with Bluetooth
- Communication via IO-Link with SIRIUS 3UG5816 relay and display and transmission of actual value and power system fault type to controller
- All versions with removable terminals
- All versions with screw or spring-loaded terminals (push-in)

Application

The relays are used above all for mobile equipment, e.g. air conditioning compressors, refrigerating containers, building site compressors and cranes.

Function	Application
Phase sequence	• Direction of rotation of the drive
Phase failure	• A fuse has tripped • Failure of the control supply voltage • Broken cable
Phase asymmetry	• Overheating of the motor due to asymmetrical voltage • Detection of asymmetrically loaded networks
Undervoltage	• Increased current on a motor with corresponding overheating • Unintentional resetting of a device • Network collapse, particularly with battery power
Overvoltage	• Protection of a plant against destruction due to overvoltage
Frequency	• Ensuring power quality • Deviation of speed affecting cycle times

Technical specifications

More information

Technical specifications, see
<https://support.industry.siemens.com/cs/ww/en/ps/25412/td>
 Equipment Manual, see
<https://support.industry.siemens.com/cs/ww/en/view/109814940>

FAQs, see <https://support.industry.siemens.com/cs/ww/en/ps/25412/faq>

Article number	3UG5511- .AR20, 3UG5511- .BR20, 3UG5512- .AR20, 3UG5512- .BR20	3UG5512- .AR21, 3UG5512- .BR21	3UG5514- .BR20	3UG5616- .CR20, 3UG5618- .CR20	3UG5618- .CR21	3UG5716- .CR20	3UG5816- .AA40
----------------	---	---	---------------------------	---	---------------------------	---------------------------	---------------------------

General technical specifications

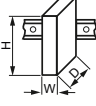

Width x height x depth		mm	22.5 x 100 x 90				
Ambient temperature		°C	-25 ... +60				
• During operation		°C	-40 ... +85				
• During storage		°C	-40 ... +85				
• During transport		°C	-40 ... +85				
Degree of protection IP			IP20				
Mounting position			Any				
Installation altitude at height above sea level, maximum		m	2 000				
Electrical endurance (operating cycles) for AC-15 at 230 V typical			100 000				
Mechanical endurance (operating cycles), typical			10 000 000				
Adjustable ON-delay time							
• On starting		s	--			0.1 ... 30	
• On upper or lower limit violation		s	--	0.1 ... 20		0.1 ... 30	
Performance Level (PL) according to ISO 13849-1			--	PL c	--	PL c	--
Safety Integrity Level (SIL) according to IEC 62061			--	SIL 1	--	SIL 1	--
Vibration resistance according to IEC 60068-2-6		Hz; mm	10 ... 55; 0.35				
Shock resistance according to IEC 60068-2-27		g/ms	Half-sine wave 15/11				
Electromagnetic compatibility			IEC 60947-1/IEC 61000-6-2/IEC 61000-6-4				
Electrical separation between input and output			Yes				
Type of electrical separation			Electrical separation				Protective separation
Electromagnetic interference emission according to IEC 60947-1			Class A				
IO-Link protocol is supported			No				Yes
Type of interface Bluetooth			No				Yes
							Yes
Measuring circuit							
Number of CO contacts with delayed switching			0	2			1
Control circuit							
Current-carrying capacity of the output relay		A	3				
• At AC-15 at 50/60 Hz at 250 V		A	1				
• At DC-13		A	0.2				
- At 24 V		A	0.1				
- At 125 V		A					
- At 250 V		A					
Thermal current of the non-solid-state contact blocks, maximum		A	5				
Insulation voltage for overvoltage category III according to IEC 60664 for pollution degree 3		V	690				
Impulse withstand voltage		kV	6				
Neutral conductor monitoring, adjustable			No		Yes		
Control supply voltage							
• 1 at AC							
- At 50 Hz		V	200 ... 690		--		
- At 60 Hz		V	200 ... 690		--		
• 2 at AC							
- At 50 Hz		V	--		120 ... 400		--
- At 60 Hz		V	--		120 ... 400		--
• At DC		V	--				24

Monitoring and control devices

Relays

SIRIUS 3UG5 monitoring relays for stand-alone installation

Line monitoring

Article number	3UG5511-.AR20, 3UG5511-.BR20, 3UG5512-.AR20, 3UG5512-.BR20	3UG5512-.AR21, 3UG5512-.BR21	3UG5514-.BR20	3UG5616-.CR20, 3UG5618-.CR20	3UG5618-.CR21	3UG5716-.CR20	3UG5816-.AA40
Control circuit (continued)							
Operating range factor of the control supply voltage, rated value at AC							
<ul style="list-style-type: none"> At 50 Hz At 60 Hz 							
		0.85 ... 1.1					--
		0.85 ... 1.1					--
Measurable voltage at AC							
<ul style="list-style-type: none"> 1 2 							
V		160 ... 760					
V		--		90 ... 440			
Supply voltage frequency							
Hz		15 ... 70					--
Adjustable open-/closed-circuit principle							
		No		Yes			
Contact reliability of the auxiliary contacts							
		One contact failure per 100 million (17 V, 5 mA)					
Article number	3UG551-1....., 3UG561-1....., 3UG571-1....., 3UG581-1.....			3UG551-2....., 3UG561-2....., 3UG571-2....., 3UG581-2.....			
Type of electrical connection							
		 Screw terminals		 Spring-loaded terminals (push-in)			
Tightening torque							
Nm		0.6 ... 0.8		--			
Type of connectable conductor cross-sections							
<ul style="list-style-type: none"> Solid Finely stranded <ul style="list-style-type: none"> Without end sleeve With end sleeve For AWG cables <ul style="list-style-type: none"> Solid Stranded 							
		1 x (0.5 ... 4 mm ²), 2 x (0.5 ... 2.5 mm ²)		1 x (0.5 ... 4 mm ²)			
		--		1 x (0.5 ... 4 mm ²)			
		1 x (0.5 ... 4 mm ²), 2 x (0.5 ... 2.5 mm ²)		1 x (0.5 ... 2.5 mm ²)			
		1 x (20 ... 12), 2 x (20 ... 14)		1 x (20 ... 12)			
		--		1 x (20 ... 12)			

3UG5511 monitoring relays

The 3UG5511 phase sequence relay monitors the phase sequence in a 3-phase network. No adjustments are required for operation. The device has an internal power supply and works using the closed-circuit principle. If the phase sequence at the terminals L1-L2-L3 is correct, the output relay picks up after the corresponding response time and the green LED is lit. If the phase sequence is wrong, the output relay remains in its rest position.

Note:

When one phase fails, connected loads (motor windings, lamps, transformers, coils, etc.) create a feedback voltage at the terminal of the failed phase due to the network coupling. Since the 3UG5511 relays are not resistant to voltage feedback, such a phase failure is not detected. If this is required, the 3UG5512 monitoring relay must be used.

Correct phase sequence

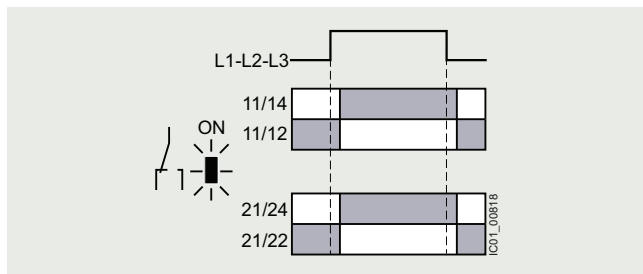

Wrong phase sequence

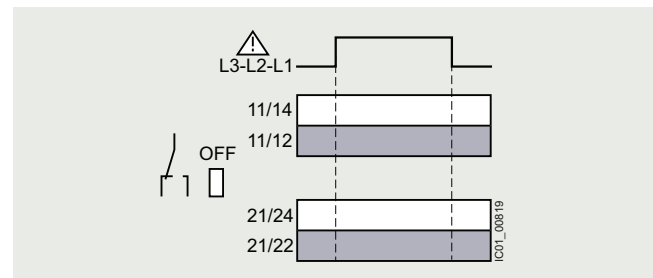

3UG5512 monitoring relays

The 3UG5512 line monitoring relay monitors 3-phase networks with regard to phase sequence, phase failure and phase asymmetry of 10%. Thanks to a special measuring method, a phase failure is reliably detected in spite of the wide voltage range from 160 to 690 V AC and feedback through the load of up to 90%. The device has an internal power supply and works using the closed-circuit principle. No adjustments are required. If the line voltage is switched on, the green LED will light up. If the phase sequence at terminals L1-L2-L3 is correct and there is no phase asymmetry, the output relay is energized. If the phase sequence is wrong or if there is phase asymmetry, the red LED flashes and the output relay remains in its rest position. If a phase fails, the red LED is permanently lit and the output relay drops. The device is also available as a version with SIL 1/PL c certification.

Note:

The red LED is a fault diagnostic indicator and does not show the current relay status. The 3UG5512 monitoring relay is suitable for line frequencies from 15 to 70 Hz.

Phase failure

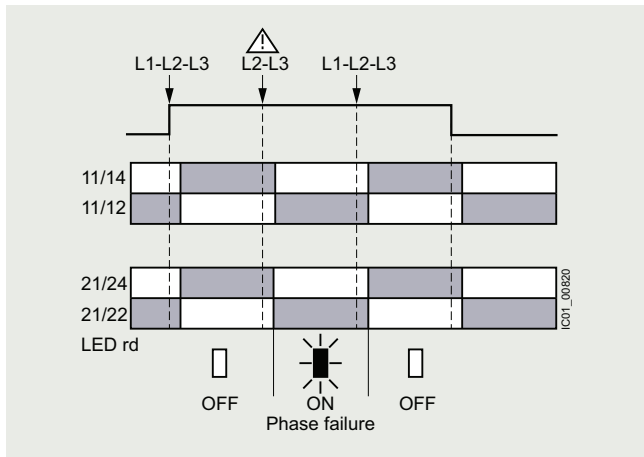

Wrong phase sequence

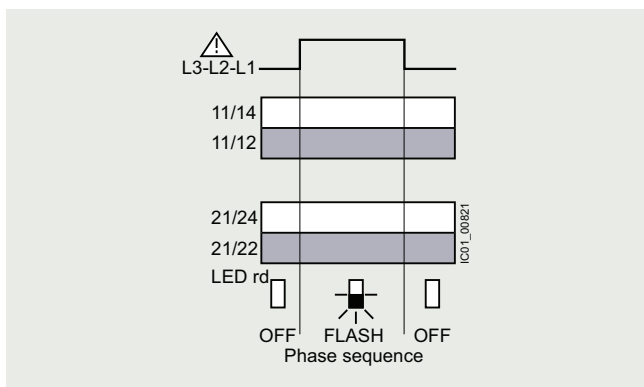

3UG5514 monitoring relays

The 3UG5514 line monitoring relay monitors 3-phase networks with regard to phase sequence, phase failure, phase asymmetry and undervoltage of 20%. The device has an internal power supply and works using the closed-circuit principle. The hysteresis is 5%. The integrated ON-delay time is adjustable from 0.1 to 20 s and responds to undervoltage. If the direction of rotation is incorrect, the device switches off immediately. Thanks to a special measuring method, a phase failure is reliably detected in spite of the wide voltage range from 160 to 690 V AC and feedback through the load of up to 80%. If the line voltage is switched on, the green LED will light up. If the phase sequence at the terminals L1-L2-L3 is correct, the output relay picks up. If the phase sequence is wrong, the red LED flashes and the output relay remains in its rest position. If a phase fails, the red LED is permanently lit and the output relay drops.

Note:

The red LED is a fault diagnostic indicator and does not show the current relay status. The 3UG5514 monitoring relay is suitable for line frequencies from 15 to 70 Hz.

Phase failure and undervoltage

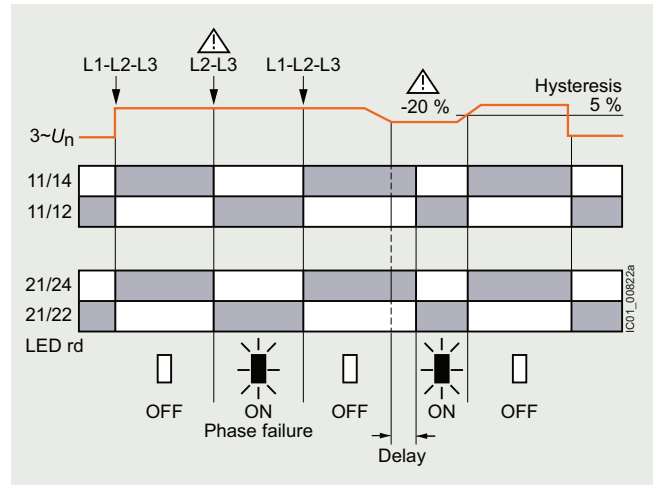

Wrong phase sequence

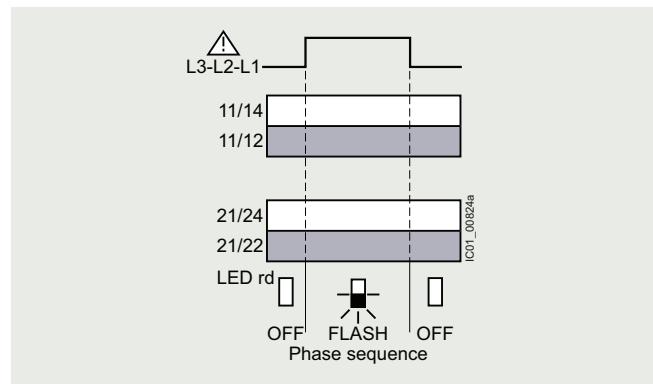

Monitoring and control devices

Relays

SIRIUS 3UG5 monitoring relays for stand-alone installation

Line monitoring

Phase asymmetry

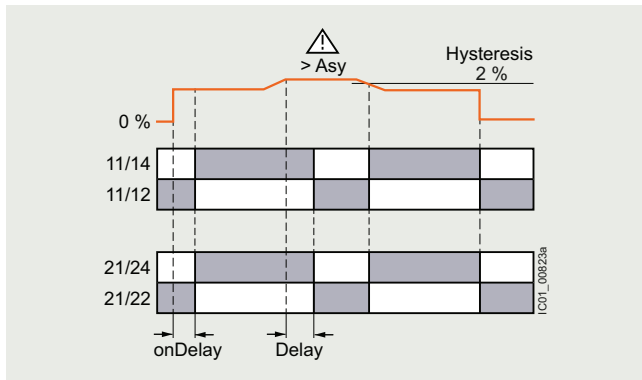

3UG5616 and 3UG5716 monitoring relays

The 3UG5616 or 3UG5716 line monitoring relay has a wide voltage range input and an internal power supply. The device is equipped with a display and is parameterized using four buttons. The 3UG5716 relay can be additionally configured via Bluetooth using the SENTRON Powerconfig app. The 3UG5616 or 3UG5716 relay monitors 3-phase networks for phase failure, undervoltage, overvoltage, frequency and phase sequence. The hysteresis is adjustable from 0.1 to 300 V. In addition the device has two separately adjustable delay times for overshooting and undershooting limits. If the direction of rotation is incorrect, the device switches off immediately. Thanks to a special measuring method, a phase failure is reliably detected in spite of the wide voltage range from 160 to 690 V AC and feedback through the load of up to 80%.

The 3UG5616 or 3UG5716 monitoring relay can be operated on the basis of either the open-circuit or closed-circuit principle and with manual or automatic RESET.

With the closed-circuit principle selected

Wrong phase sequence

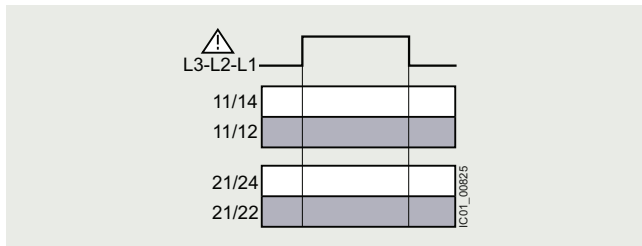

Phase failure

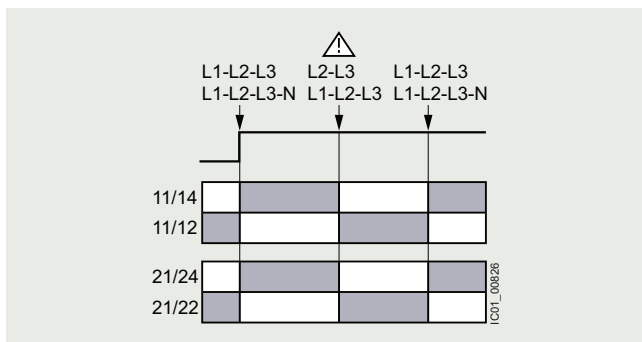

Undervoltage, frequency undershoot

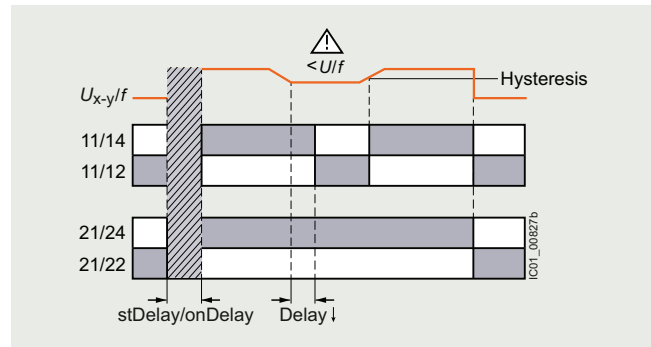

Overvoltage, frequency overshoot

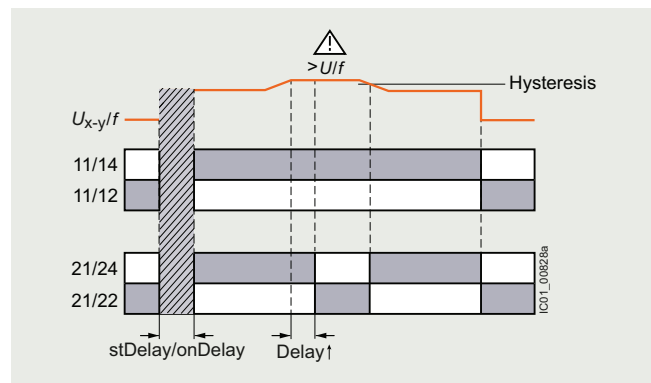

3UG5816 monitoring relays

The 3UG5816 line monitoring relays have a wide voltage range input and are supplied with power through IO-Link or from an external 24 V DC source.

The device is equipped with a display and is parameterized using four buttons. The 3UG5816 monitoring relay monitors a 3-phase network for phase sequence, phase failure, phase asymmetry, frequency, undervoltage and overvoltage. The hysteresis is adjustable from 0.1 to 300 V.

In addition the device has two separately adjustable delay times for overshooting and undershooting limits. If the direction of rotation is incorrect or a phase fails, the device switches off immediately. Thanks to a special measuring method, a phase failure is reliably detected in spite of the wide voltage range from and potentially high feedback through the load.

The 3UG5816 monitoring relays can be operated based on either the open-circuit or closed-circuit principle and with manual or automatic RESET.

With the closed-circuit principle selected

Wrong phase sequence

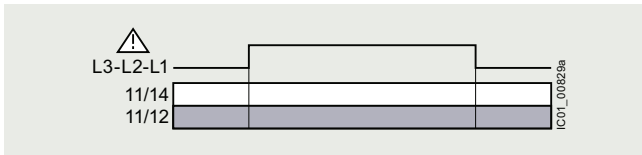

Phase failure

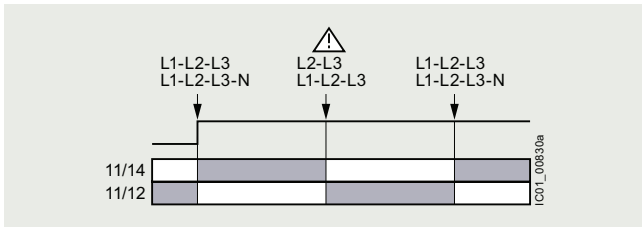

Undervoltage, frequency undershoot

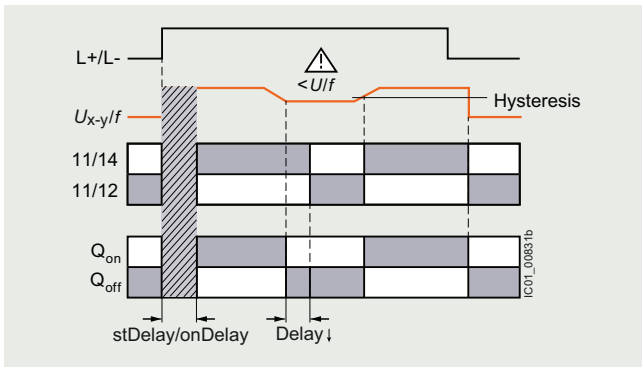

Overvoltage, frequency overshoot

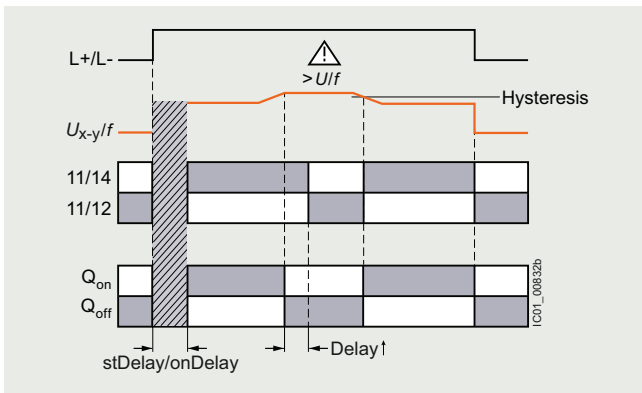

3UG5618 monitoring relays

The 3UG5618 line monitoring relay has an internal power supply and can automatically correct a wrong direction of rotation. Thanks to a special measuring method, a phase failure is reliably detected in spite of the wide voltage range from 160 to 690 V AC and feedback through the load of up to 80%.

The device is equipped with a display and is parameterized using three buttons. It monitors 3-phase networks for phase sequence, phase failure, phase asymmetry, frequency, undervoltage and overvoltage. The hysteresis is adjustable from 0.1 to 300 V.

In addition the device has two separately adjustable delay times for overshooting and undershooting limits. The monitoring relay can be operated on the basis of either the open-circuit or closed-circuit principle and with manual or automatic RESET.

One of the CO contacts is used for warning or disconnection in the event of power system faults (voltage, frequency, asymmetry), the other one responds only to a wrong phase sequence. In conjunction with a contactor reversing assembly it is thus possible to change the direction of rotation automatically. The device is also available as a version with SIL 1/PL c certification.

With the closed-circuit principle selected

Phase failure

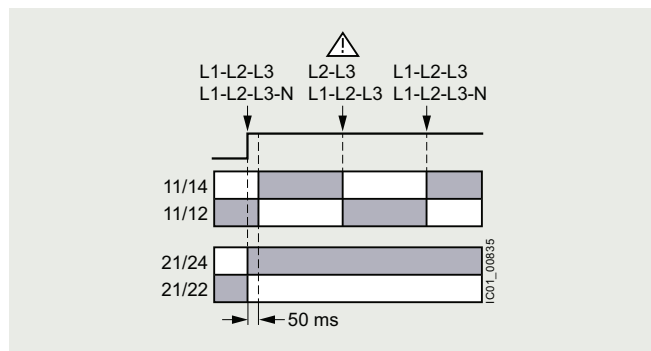

Undervoltage, frequency undershoot

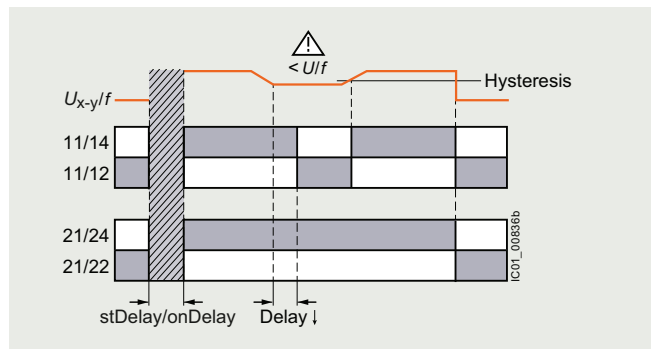

Monitoring and control devices

Relays
SIRIUS 3UG5 monitoring relays for stand-alone installation



Line monitoring

Overvoltage, frequency overshoot

Phase asymmetry

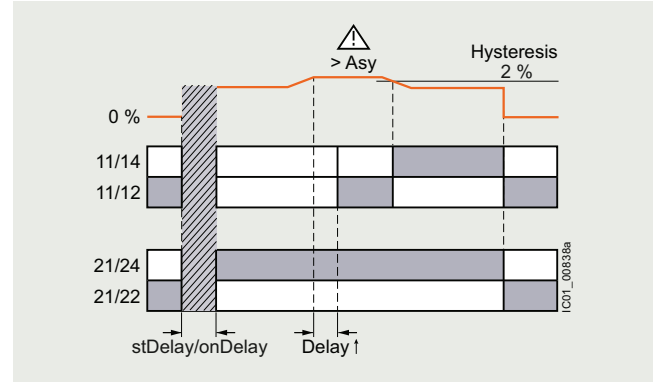
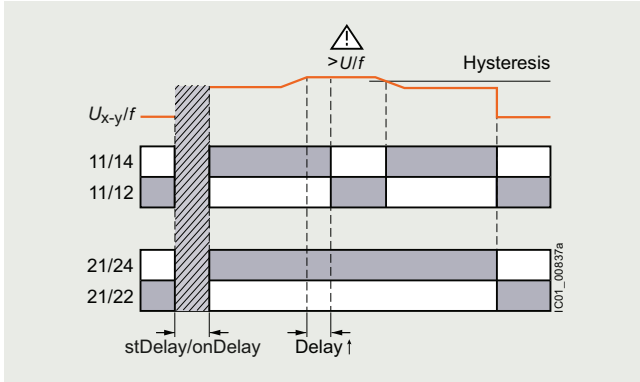

Selection and ordering data

PU (UNIT, SET, M) = 1
PS* = 1 unit
PG = 41H

Multi-unit packaging, see page 16/7.



3UG5511-2AR20



3UG5514-2BR20



3UG5816-2AA40

Phase failure detection	Undervoltage detection in 3 phases	Overvoltage detection in 3 phases	Frequency measurement	Adjustable ON-delay time		Number of CO contacts for auxiliary contacts	Screw terminals		Spring-loaded terminals (push-in)	
				on starting	on upper or lower limit violation		Article No.	Price per PU	Article No.	Price per PU
				s	s					

Line monitoring relays with fixed function

Monitoring of phase sequence

--	--	--	--	--	--	1	3UG5511-1AR20	3UG5511-2AR20
						2	3UG5511-1BR20	3UG5511-2BR20

Monitoring of phase sequence, phase failure, and phase asymmetry

✓	--	--	--	--	--	1	3UG5512-1AR20	3UG5512-2AR20
						2	3UG5512-1BR20	3UG5512-2BR20

• For safety applications

✓	--	--	--	--	--	1	3UG5512-1AR21	3UG5512-2AR21
						2	3UG5512-1BR21	3UG5512-2BR21

Analogically adjustable line monitoring relays

Monitoring of phase sequence, phase failure, phase asymmetry, and undervoltage

✓	✓	--	--	--	0.1 ... 20	2	3UG5514-1BR20	3UG5514-2BR20
---	---	----	----	----	------------	---	---------------	---------------

Digitally adjustable line monitoring relays

Monitoring of phase sequence, phase failure, phase asymmetry, N conductor (adjustable), frequency, undervoltage and overvoltage

✓	✓	✓	✓	0.1 ... 30	0.1 ... 30	2	3UG5616-1CR20	3UG5616-2CR20
---	---	---	---	------------	------------	---	---------------	---------------

• With Bluetooth

✓	✓	✓	✓	0.1 ... 30	0.1 ... 30	2 NEW	3UG5716-1CR20	3UG5716-2CR20
---	---	---	---	------------	------------	--------------	---------------	---------------

• For IO-Link

✓	✓	✓	✓	0.1 ... 30	0.1 ... 30	1	3UG5816-1AA40	3UG5816-2AA40
---	---	---	---	------------	------------	---	---------------	---------------

Automatic correction of direction of rotation in case of wrong phase sequence, monitoring of phase failure, phase asymmetry, N conductor (adjustable), frequency, undervoltage and overvoltage

✓	✓	✓	✓	0.1 ... 30	0.1 ... 30	2	3UG5618-1CR20	3UG5618-2CR20
---	---	---	---	------------	------------	---	---------------	---------------

• For safety applications

✓	✓	✓	✓	0.1 ... 30	0.1 ... 30	2	3UG5618-1CR21	3UG5618-2CR21
---	---	---	---	------------	------------	---	---------------	---------------

✓ Function available

-- Function not available

Accessories, see page 10/110.

Overview

SIRIUS 3UG5532 voltage monitoring relay

The analogically adjustable voltage monitoring relays monitor 1-phase AC voltages (rms value) and DC voltages against the set threshold value for overshoot and undershoot. The devices differ with regard to their power supply (internal or external).

Note:

Digital monitoring relay with voltage monitoring, [see page 10/90](#).

Benefits

- All versions with wide voltage supply range
- Variably adjustable to overshoot, undershoot or range monitoring
- Freely configurable delay times
- Width 22.5 mm
- All versions with removable terminals
- All versions with screw or spring-loaded terminals (push-in)

Application

- Protection of a plant against destruction due to overvoltage
- Switch-on of a plant at a defined voltage and higher
- Protection from undervoltage due to overloaded supply voltages, particularly with battery power
- Threshold switch for analog signals from 0.1 to 10 V



Monitoring and control devices

Relays

SIRIUS 3UG5 monitoring relays for stand-alone installation

Voltage monitoring **NEW**

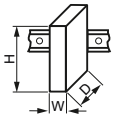
Technical specifications

More information			
Technical specifications, see https://support.industry.siemens.com/cs/ww/en/ps/25412/td		Equipment Manual, see https://support.industry.siemens.com/cs/ww/en/view/109814940 FAQs, see https://support.industry.siemens.com/cs/ww/en/ps/25412/faq	
Article number		3UG5532-AW30	3UG5533-AL30
General data			
Width x height x depth		mm	22.5 x 100 x 90
Ambient temperature			
• During operation	°C	-25 ... +60	
• During storage	°C	-40 ... +80	
• During transport	°C	-40 ... +80	
Degree of protection IP		IP20	
Mounting position		Any	
Installation altitude at height above sea level, maximum	m	2 000	
Electrical endurance (operating cycles) for AC-15 at 230 V typical		100 000	
Mechanical endurance (operating cycles), typical		10 000 000	
Adjustable ON-delay time on upper or lower limit violation	s	0.5 ... 30	
Vibration resistance according to IEC 60068-2-6		$f = 4 \dots 5.81 \text{ Hz}$, $d_{\text{max}} = 15 \text{ mm}$; $f = 5.81 \dots 500 \text{ Hz}$, $A_{\text{max}} = 20 \text{ m/s}^2$; 10 cycles	
Shock resistance according to IEC 60068-2-27	g/ms	Half-sine wave 15/11	
Electromagnetic compatibility		IEC 60947-1/IEC 61000-6-2/IEC 61000-6-4	
Electrical separation between input and output		Yes	
Type of electrical separation		Electrical separation	
Insulation voltage for overvoltage category III according to IEC 60664			
• For pollution degree 2	V	690	
• For pollution degree 3	V	690	
Impulse withstand voltage	kV	6	
Measuring circuit			
Measurable voltage			
• At AC	V	10 ... 760	20 ... 275
• At DC	V	10 ... 760	20 ... 275
Adjustable voltage range	V	10 ... 760	20 ... 275
Control circuit			
Thermal current of the non-solid-state contact blocks, maximum	A	5	
Current-carrying capacity of the output relay			
• At AC-15 at 400 V at 50/60 Hz	A	3	
• At DC-13			
- At 24 V	A	1	
- At 125 V	A	0.2	
- At 250 V	A	0.1	
Operational current at 17 V, minimum	mA	5	
Article number		3UG553-1A.30	3UG553-2A.30
Type of electrical connection		 Screw terminals	 Spring-loaded terminals (push-in)
Tightening torque		0.6 ... 0.8 Nm	--
Type of connectable conductor cross-sections			
• Solid		1 x (0.5 ... 4 mm ²), 2 x (0.5 ... 2.5 mm ²)	1 x (0.5 ... 4 mm ²)
• Finely stranded		--	1 x (0.5 ... 4 mm ²)
- Without end sleeve		1 x (0.5 ... 4 mm ²), 2 x (0.5 ... 2.5 mm ²)	1 x (0.5 ... 2.5 mm ²)
- With end sleeve		--	--
• For AWG cables			
- Solid		1 x (20 ... 12), 2 x (20 ... 14)	1 x (20 ... 12)
- Stranded		--	1 x (20 ... 12)

3UG5532 monitoring relays

The externally powered 3UG5532 voltage monitoring relay performs overshoot, undershoot or range monitoring of the voltage depending on parameterization.

If one of these threshold values is reached, the output relay responds as soon as the delay time has elapsed. This delay time can be adjusted between 0.5 s and 30 s. The devices are parameterized using rotary switches.

The device works on the closed-circuit principle. One output changeover contact is available as signaling contact.

Overvoltage

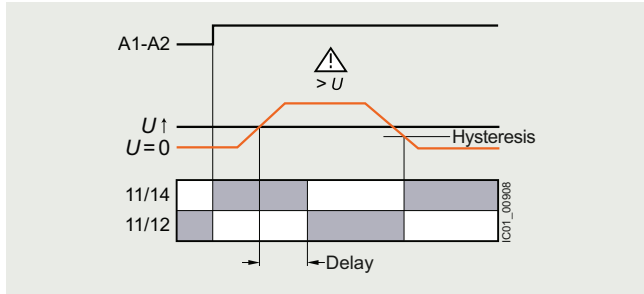

Undervoltage

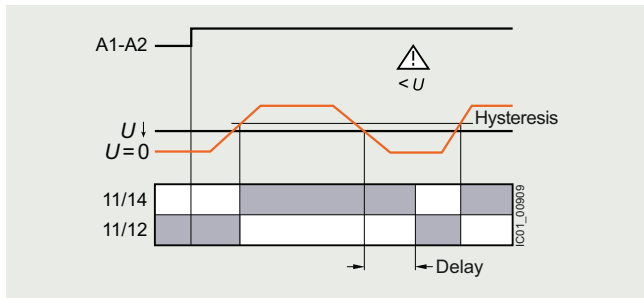

Range monitoring

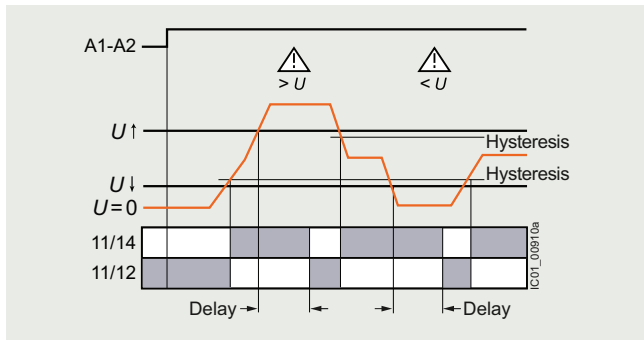

3UG5533 monitoring relays

The analogically adjustable 3UG5533 voltage monitoring relay has an internal power supply and performs overshoot, undershoot or range monitoring of the voltage depending on parameterization.

The operating and measuring range extends from 20 to 275 V AC/DC. The threshold values for overshoot or undershoot can be freely configured within this range. If one of these threshold values is reached, the output relay responds as soon as the tripping delay time has elapsed. This delay time can be adjusted between 0.5 s and 30 s.

The device works on the closed-circuit principle. One output changeover contact is available as signaling contact.

Digital monitoring relay with voltage monitoring, [see page 10/90](#).

Overvoltage

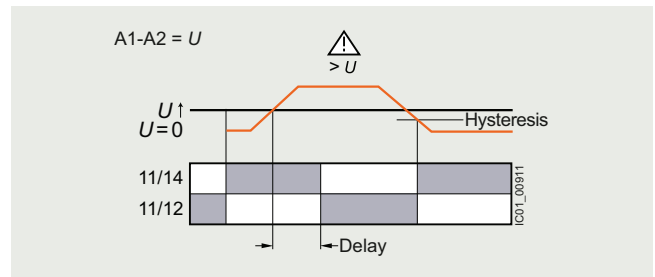

Undervoltage

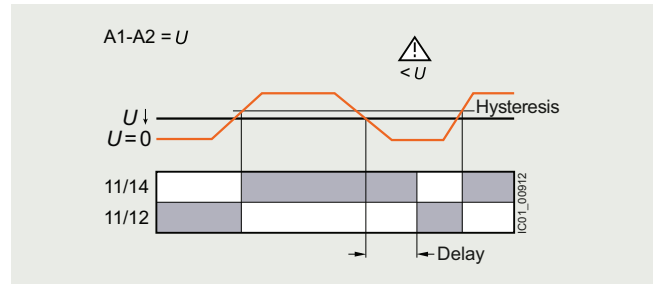

Range monitoring

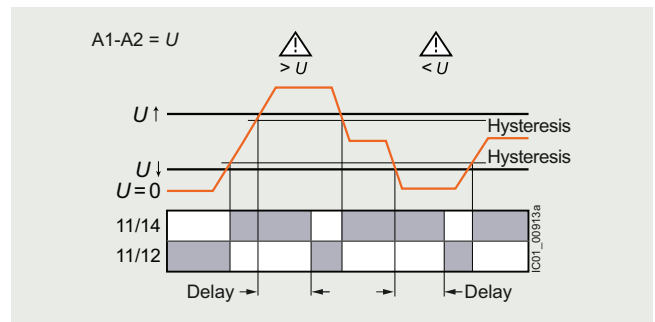

Monitoring and control devices

Relays

SIRIUS 3UG5 monitoring relays for stand-alone installation



Voltage monitoring **NEW**

Selection and ordering data

PU (UNIT, SET, M) = 1
 PS* = 1 unit
 PG = 41H



Multi-unit packaging, see page 16/7.



3UG5532-1AW30



3UG5533-2AL30

Adjustable voltage range	Control supply voltage			Adjustable ON-delay time on upper or lower limit violation	Number of CO contacts with delayed switching	Screw terminals 		Spring-loaded terminals (push-in) 	
	at AC at 50 Hz	at AC at 60 Hz	at DC			Article No.	Price per PU	Article No.	Price per PU
V	V	V	V	s					

Analogically adjustable voltage monitoring relay

Monitoring of undervoltage and overvoltage, internally powered without auxiliary voltage

20 ... 275 AC/DC	24 ... 240	24 ... 240	24 ... 240	0.5 ... 30	1	3UG5533-1AL30		3UG5533-2AL30	
------------------	------------	------------	------------	------------	---	----------------------	--	----------------------	--

Monitoring of undervoltage and overvoltage, externally powered with auxiliary voltage

10 ... 760 AC/DC	24 ... 240	24 ... 240	24 ... 240	0.5 ... 30	1	3UG5532-1AW30		3UG5532-2AW30	
------------------	------------	------------	------------	------------	---	----------------------	--	----------------------	--

Accessories, see page 10/110.

Overview

SIRIUS 3UG522 current monitoring relay

The analogically adjustable current monitoring relays monitor 1-phase AC (rms value) and DC currents against the set threshold value for overshoot and undershoot.

Note:

Digital monitoring relays with current monitoring, see [page 10/90](#).

Benefits

- Wide voltage supply range
- Variably adjustable to overshoot, undershoot or range monitoring
- Width 22.5 mm
- All versions with removable terminals
- All versions with screw or spring-loaded terminals (push-in)

Application

- Overcurrent and undercurrent monitoring
- Monitoring the functionality of electrical loads
- Open-circuit monitoring

Monitoring and control devices

Relays

SIRIUS 3UG5 monitoring relays for stand-alone installation

Current monitoring **NEW**

Technical specifications

More information

Technical specifications, see
<https://support.industry.siemens.com/cs/ww/en/ps/25412/td>

Equipment Manual, see
<https://support.industry.siemens.com/cs/ww/en/view/109814940>
 FAQs, see <https://support.industry.siemens.com/cs/ww/en/ps/25412/faq>

Article number

3UG5522-AW30

General data

Width x height x depth

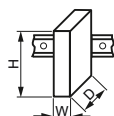

mm 22.5 x 100 x 90

Ambient temperature

- During operation °C -25 ... +60
- During storage °C -40 ... +80
- During transport °C -40 ... +80

Degree of protection IP

IP20

Mounting position

Any

Installation altitude at height above sea level, maximum

m 2 000

Electrical endurance (operating cycles) for AC-15 at 230 V typical

100 000

Mechanical endurance (operating cycles), typical

10 000 000

Adjustable ON-delay time on upper or lower limit violation

s 0.5 ... 30

Vibration resistance according to IEC 60068-2-6

$f = 4 \dots 5.81 \text{ Hz}$, $d_{\text{max}} = 15 \text{ mm}$; $f = 5.81 \dots 500 \text{ Hz}$, $A_{\text{max}} = 20 \text{ m/s}^2$; 10 cycles

Shock resistance according to IEC 60068-2-27

g/ms Half-sine wave 15/11

Electromagnetic compatibility

IEC 60947-1/IEC 61000-6-2/IEC 61000-6-4

Electrical separation between input and output

Yes

Type of electrical separation

Electrical separation

Insulation voltage for overvoltage category III according to IEC 60664

- For pollution degree 2 V 690
- For pollution degree 3 V 690

Impulse withstand voltage

kV 6

Measuring circuit

Measurable current

A 0.05 ... 10

Control circuit

Thermal current of the non-solid-state contact blocks, maximum

A 5

Current-carrying capacity of the output relay

- At AC-15 at 400 V at 50/60 Hz A 3
- At DC-13
 - At 24 V A 1
 - At 125 V A 0.2
 - At 250 V A 0.1

Operational current at 17 V, minimum

A 5

Article number

3UG5522-1AW30

3UG5522-2AW30

Type of electrical connection

 Screw terminals

 Spring-loaded terminals (push-in)

Tightening torque

0.6 ... 0.8 Nm

--

Type of connectable conductor cross-sections

- Solid 1 x (0.5 ... 4 mm²), 2 x (0.5 ... 2.5 mm²) 1 x (0.5 ... 2.5 mm²)
- Finely stranded
 - Without end sleeve -- 1 x (0.5 ... 4 mm²)
 - With end sleeve 1 x (0.5 ... 4 mm²), 2 x (0.5 ... 2.5 mm²) 1 x (0.5 ... 2.5 mm²)
- For AWG cables
 - Solid 1 x (20 ... 12), 2 x (20 ... 14) 1 x (20 ... 12)
 - Stranded -- 1 x (20 ... 12)

3UG5522 monitoring relays

The 3UG5522 current monitoring relay is supplied with an auxiliary voltage of 24 to 240 V AC/DC and performs overshoot, undershoot or range monitoring of the current depending on parameterization. The device is parameterized by means of three rotary switches and has one changeover contact.

The measuring range extends from 0.05 to 10 A. The rms value of the current is measured. The threshold values for overshoot or undershoot can be freely configured within this range. If one of these threshold values is reached, the output relay responds as soon as the tripping delay time has elapsed. This time can be adjusted between 0.5 s and 30 s. The device works on the closed-circuit principle.

Current overshoot

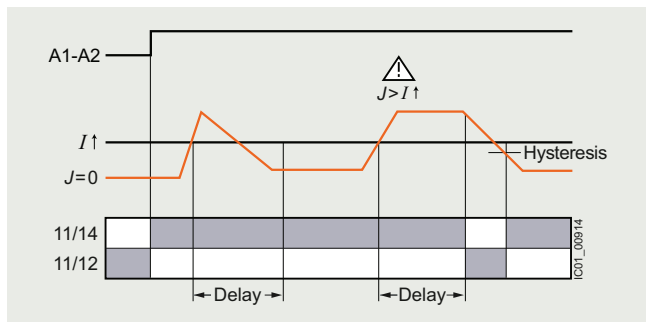

Current undershoot

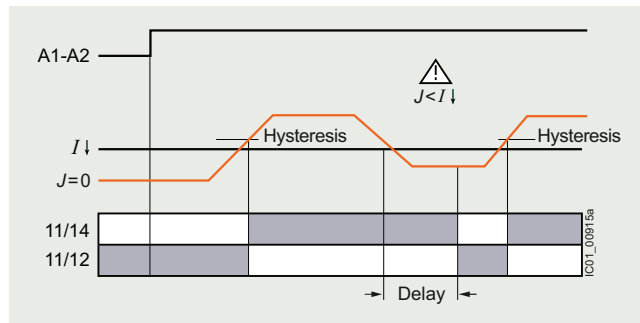

Range monitoring

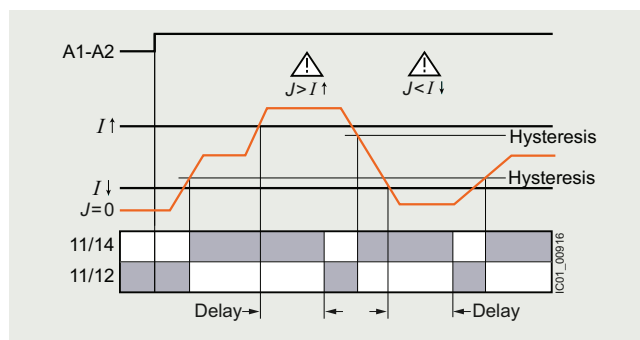

Selection and ordering data

PU (UNIT, SET, M) = 1
 PS* = 1 unit
 PG = 41H

Multi-unit packaging, see page 16/7.



3UG5522-1AW30



3UG5522-2AW30

Measurable current	Control supply voltage			Adjustable ON-delay time on upper or lower limit violation	Number of CO contacts with delayed switching
	at AC at 50 Hz	at 60 Hz	at DC		
A	V	V	V	s	

Screw terminals		
Article No.	Price per PU	

Spring-loaded terminals (push-in)		
Article No.	Price per PU	

Analogically adjustable current monitoring relays					
Monitoring of undercurrent and overcurrent, externally powered with auxiliary voltage					
0.05 ... 10	24 ... 240	24 ... 240	24 ... 240	0.5 ... 30	1

3UG5522-1AW30

3UG5522-2AW30

Accessories, see page 10/110.

For AC currents $I > 10$ A it is possible to use 4NC current transformers as an accessory, see Catalog LV 10.

Monitoring and control devices

Relays

SIRIUS 3UG5 monitoring relays for stand-alone installation

Current, active current, voltage, power factor, and power monitoring **NEW**

Overview



SIRIUS 3UG5643 monitoring relay

With the 3UG5 current, active current, voltage, power factor and power monitoring relay, it is possible to perform load monitoring of motors.

The 3UG5742 relay can be conveniently, easily and clearly parameterized on a smartphone using the SENTRON Powerconfig app. The current values can also be displayed.

The 3UG5842 relay can be parameterized via IO-Link using a PC. By connection to the controller, the values of the device can be used for ongoing operation or for maintenance.

The 3UG5642 relay is available as a version with SIL 1/PL c.

Benefits

- Can be used worldwide thanks to wide voltage range
- Monitoring of even small 1-phase motors with a no-load current below 0.5 A
- Simple determination of threshold values by directly referencing measured variables to motor loading
- Range monitoring and active current measurement enable detection of cable breaks between control cabinets and motors, as well as phase failures
- Selectable device function: Current, voltage, power factor (I_{res}) and power
- Devices with Safety certification according to SIL 1/PL c
- Devices with Bluetooth
- Communication via IO-Link with the SIRIUS 3UG5842 relay and display and transmission of actual values and diagnostics to the controller
- Width 22.5 mm
- All versions with removable terminals
- All versions with screw or spring-loaded terminals (push-in)

Application

- No-load monitoring and load shedding, such as in the event of a torn V-belt
- Underload monitoring in the low-end performance range, e.g. in the event of pump no-load operation
- Monitoring of overload, e.g. due to a dirty filter system
- Simple power factor monitoring in power systems for controlling compensation systems
- Broken cable between control cabinet and motor

NEW

Current, active current, voltage, power factor, and power monitoring

Technical specifications

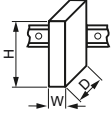

More information					
Technical specifications, see https://support.industry.siemens.com/cs/ww/en/ps/25412/td		Equipment Manual, see https://support.industry.siemens.com/cs/ww/en/view/109814940			
		FAQs, see https://support.industry.siemens.com/cs/ww/en/ps/25412/faq			
Type	3UG5642-.CW30 3UG5642-.CW31 3UG5643-.CS20 3UG5742-.CW30 3UG5842-.AA40				
General data					
Width x height x depth		mm	22.5 x 100 x 90		
Ambient temperature		°C	-25 ... +60		
• During operation		°C	-40 ... +80		
• During storage		°C	-40 ... +80		
• During transport		°C	-40 ... +80		
Degree of protection IP	IP20				
Mounting position	Any				
Installation altitude at height above sea level, maximum	m	2 000			
Electrical endurance (operating cycles) for AC-15 at 230 V typical	100 000				
Mechanical endurance (operating cycles), typical	10 000 000				
Adjustable ON-delay time		s	0 ... 999.9		
• On starting		s	0 ... 999.9		
• On upper or lower limit violation		s	0 ... 999.9		
Safety Integrity Level (SIL) according to IEC 62061	--		SIL 1	--	--
Performance Level (PL) according to ISO 13849-1	--		PL c	--	--
Vibration resistance according to IEC 60068-2-6	$f = 4 \dots 5.81 \text{ Hz}$, $d_{\text{max}} = 15 \text{ mm}$; $f = 5.81 \dots 500 \text{ Hz}$, $A_{\text{max}} = 20 \text{ m/s}^2$; 10 cycles				
Shock resistance according to IEC 60068-2-27	g/ms	Half-sine wave 15/11			
Electromagnetic compatibility	IEC 60947-1/IEC 61000-6-2/IEC 61000-6-4				
Electrical separation between input and output	Yes				
Insulation voltage for overvoltage category III according to IEC 60664		V	690		
• For pollution degree 2		V	690		
• For pollution degree 3		V	690		
Impulse withstand voltage	kV	6			
Type of interface Bluetooth	No		Yes	No	
IO-Link protocol is supported	No		Yes	Yes	
Measuring circuit					
Measurable current	A	0.003 ... 10		0.05 ... 10	0.003 ... 10
Adjustable response value current time-limited to 5 s	A	15			
Measurable voltage at AC	V	0.1 ... 760		76 ... 760	0.1 ... 760
Type of voltage for monitoring	AC/DC		AC	AC/DC	
Control circuit					
Number of CO contacts with delayed switching	2				1
Thermal current of the non-solid-state contact blocks, maximum	A	5			
Current-carrying capacity of the output relay		A	3		
• At AC-15 at 400 V at 50/60 Hz		A	1		
• At DC-13		A	0.2		
- At 24 V		A	0.1		
- At 125 V		A	0.1		
- At 250 V		A	0.1		
Operational current at 17 V, minimum	mA	5			

Monitoring and control devices

Relays

SIRIUS 3UG5 monitoring relays for stand-alone installation

Current, active current, voltage, power factor, and power monitoring **NEW**

Article number	3UG5642-1....., 3UG5643-1....., 3UG5742-1....., 3UG5842-1.....	3UG5642-2....., 3UG5643-2....., 3UG5742-2....., 3UG5842-2.....
Type of electrical connection	 Screw terminals	 Spring-loaded terminals (push-in)
Tightening torque	0.6 ... 0.8 Nm	--
Type of connectable conductor cross-sections		
• Solid	1 x (0.5 ... 4 mm ²), 2 x (0.5 ... 2.5 mm ²)	1 x (0.5 ... 4 mm ²)
• Finely stranded	--	1 x (0.5 ... 4 mm ²)
- Without end sleeve	2 x (0.5 ... 1.5 mm ²), 1 x (0.5 ... 4 mm ²)	1 x (0.5 ... 2.5 mm ²)
- With end sleeve	--	--
• For AWG cables	1 x (20 ... 12), 2 x (20 ... 14)	1 x (20 ... 12)
- Solid	--	1 x (20 ... 12)
- Stranded	--	--

3UG5642, 3UG5643, and 3UG5742 monitoring relays

The 3UG5642 and 3UG5742 monitoring relays are supplied with an auxiliary voltage of 24 to 240 V AC/DC. The 3UG5643 monitoring relay has an internal power supply.

The 3UG56 and 3UG57 relays have a display and are parameterized with four buttons.

The 3UG5742 monitoring relay can be additionally configured via Bluetooth using the SENTRON Powerconfig app, see [page 10/73](#).

Depending on the function selected, the devices are used for 1-phase monitoring of voltage, active and apparent current, active and apparent power, power factor and frequency for overshooting, undershooting or range monitoring.

If the load current overshoots the lower measuring range limit 0.05 A, the set ON-delay time begins (onDel). During this time, if the set limit values are undershot or exceeded, this does not lead to a relay reaction of the changeover contacts.

The set tripping delay time starts if one of the measured values overshoots or undershoots the corresponding set threshold value. After expiry of this time, the K1 and K2 output relays change the switching state, depending on the set relay switching response.

Using the "transformer transmission factor" parameter (I scale), the display can reproduce the measured primary current. The maximum primary current that can be measured is 9 999 A.

To adapt the monitoring relay to different external circuit connections and applications, the device can be operated according to the open-circuit or closed-circuit principle.

If manual RESET is selected in the menu, the switching relay remains in its current switching state and the current measured value and the symbol for undershooting and overshooting continue to be displayed, even when the measured variable reaches a permissible value again. This stored fault condition can be reset by pressing the Back key and confirming with the Enter key.

NEW Current, active current, voltage, power factor, and power monitoring

With the closed-circuit principle selected

Overshooting of voltage or frequency

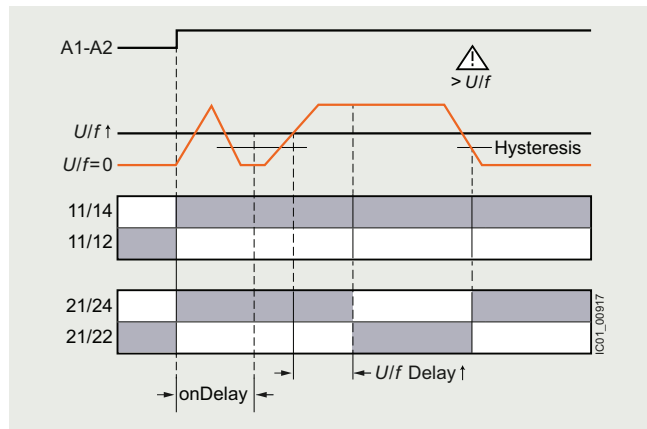

Overshooting of current

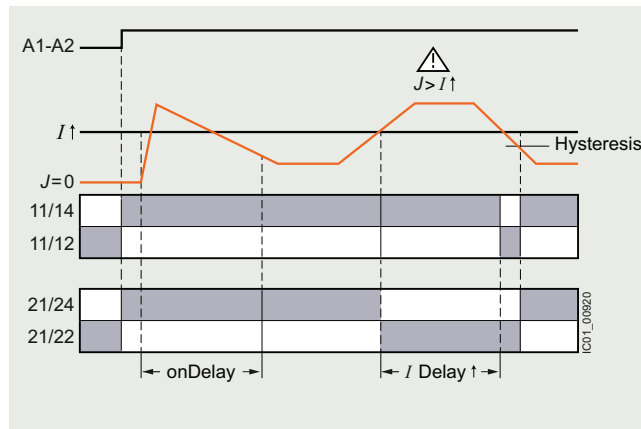

Undershooting of voltage or frequency

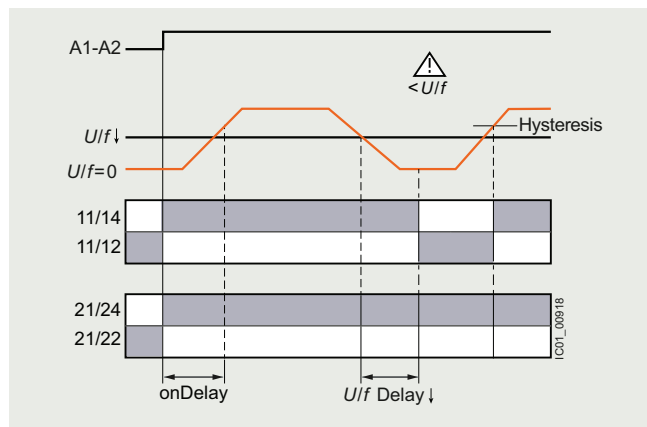

Undershooting of current

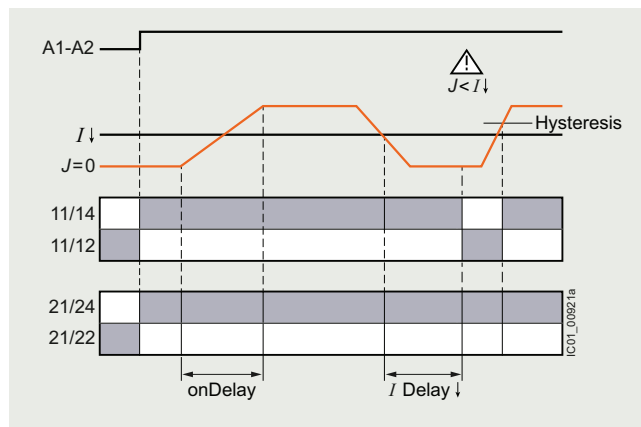

Range monitoring of voltage or frequency

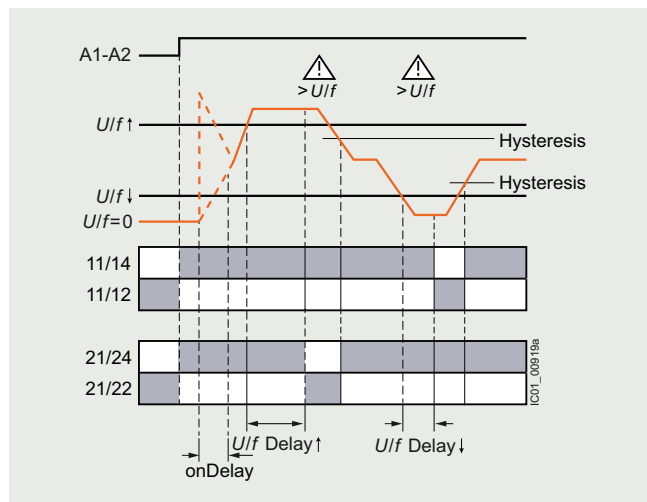

Range monitoring of current

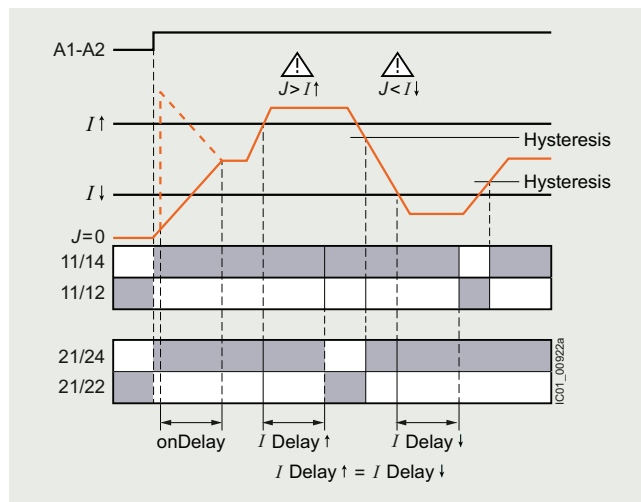

Monitoring and control devices

Relays

SIRIUS 3UG5 monitoring relays for stand-alone installation

Current, active current, voltage, power factor, and power monitoring **NEW**

Overshooting of active current

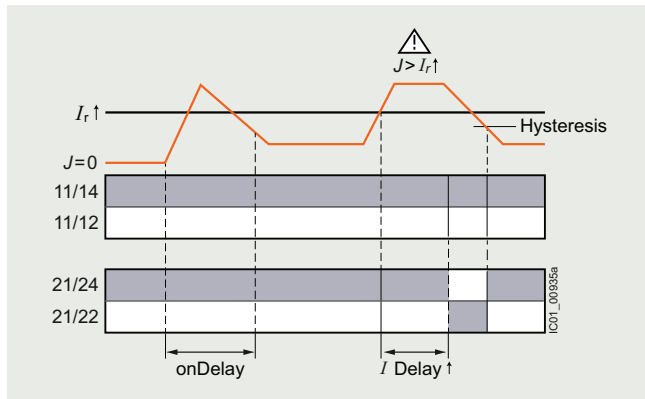

Overshooting of power factor

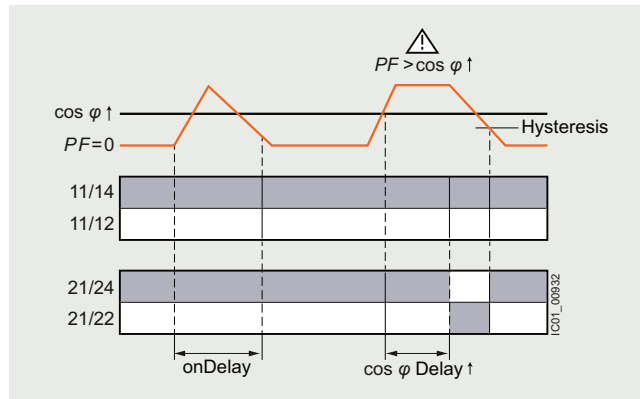

Undershooting of active current

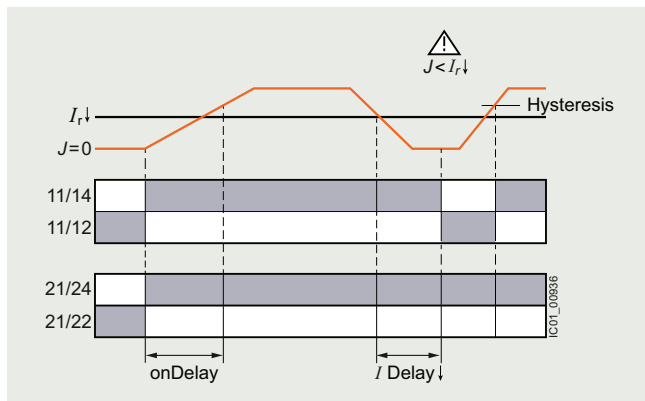

Undershooting of power factor

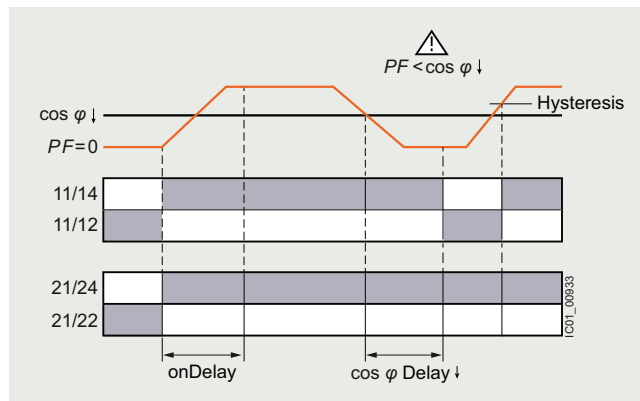

Range monitoring of active current

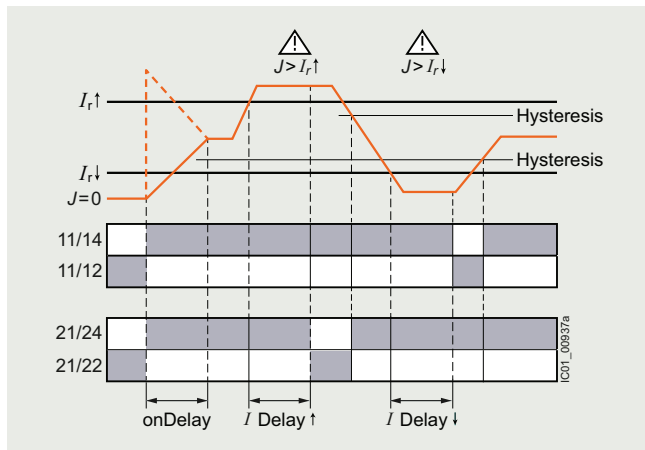

Range monitoring of power factor

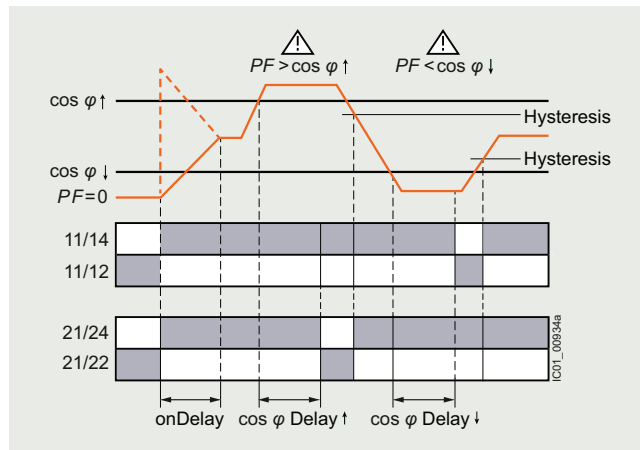

NEW Current, active current, voltage, power factor, and power monitoring

Overshooting of power

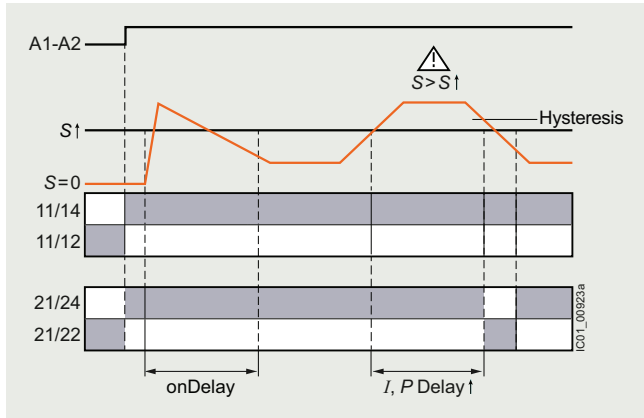

Undershooting of power

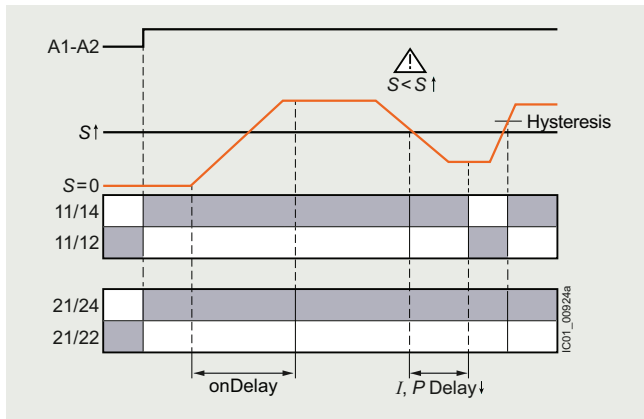

Range monitoring of power

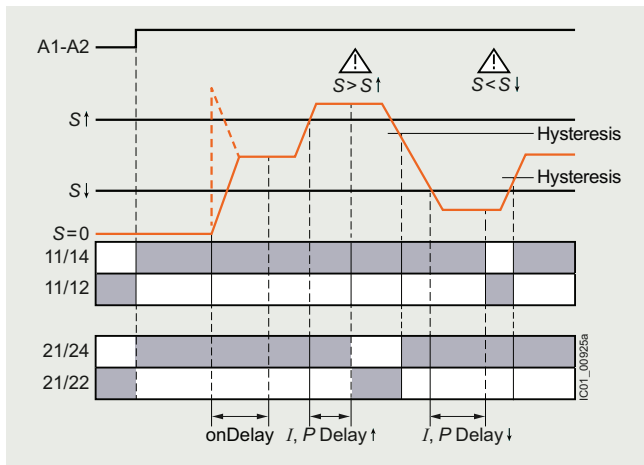

3UG5842 monitoring relays

The 3UG5842 monitoring relay is supplied with an auxiliary voltage of 24 V DC and, depending on the function selected, the devices are used for 1-phase monitoring of voltage, active and apparent current, active and apparent power, power factor and frequency for overshooting, undershooting, or range monitoring.

The 3UG5842 relays have a display and are parameterized with four buttons.

If the supply voltage is switched on and no load current is flowing, the display indicates ---. If the load current overshoots the lower measuring range limit 0.05 A, the set ON-delay time begins (onDel). During this time, undershooting or overshooting of the set threshold values will not result in a relay response of the CO contact. The set tripping delay time starts if one of the measured values overshoots or undershoots the corresponding set threshold value.

After expiry of this time, the K1 output relay changes the switching state, depending on the set relay switching response. Using the "transformer transmission factor" parameter (I scale), the display and transmission of the measured values via IO-Link can reproduce the measured primary current. The maximum primary current that can be measured is 9 999 A. To adapt the current monitoring relay to different external circuit connections and applications, the device can be operated according to the open-circuit or closed-circuit principle.

The 3UG5842 monitoring relays are equipped with a C/Q connection to IO-Link. If the IO-Link connection is not used for communication via IO-Link, the 3UG5842 relays for IO-Link operate in standard I/O mode (SIO mode). In this mode, the C/Q terminal is used as a semiconductor output that switches when the warning threshold for undershoot or overshoot is violated.

- Q_{off}: 24 V DC supply voltage present.
- Q_{on}: The output has a high resistance.

Note:

For function diagrams of the 3UG5842 devices, see [Manual](#).

Monitoring and control devices

Relays

SIRIUS 3UG5 monitoring relays for stand-alone installation



Current, active current, voltage, power factor, and power monitoring **NEW**

Selection and ordering data

PU (UNIT, SET, M) = 1
 PS* = 1 unit
 PG = 41H

Multi-unit packaging, see page 16/7.



3UG5642-1CW30



3UG5643-2CS20

Measurable current				Control supply voltage		Number of CO contacts with delayed switching	Screw terminals		Spring-loaded terminals (push-in)		
at AC		at DC		Article No.			Price per PU		Article No.		Price per PU
A	V	V	V	at 50 Hz	at 60 Hz						

Digitally adjustable monitoring relay

Monitoring of current, active current, voltage, power factor and power, internally powered without auxiliary voltage

0.05 ... 10 90 ... 690 90 ... 690 -- 2

3UG5643-1CS20

3UG5643-2CS20

Monitoring of current, active current, voltage, power factor and power, externally powered with auxiliary voltage

0.003 ... 10 24 ... 240 24 ... 240 24 ... 240 2

3UG5642-1CW30

3UG5642-2CW30

• For safety applications

0.003 ... 10 24 ... 240 24 ... 240 24 ... 240 2

3UG5642-1CW31

3UG5642-2CW31

• With Bluetooth

0.003 ... 10 24 ... 240 24 ... 240 24 ... 240 2

3UG5742-1CW30

3UG5742-2CW30

• For IO-Link

0.003 ... 10 -- -- 24 1

3UG5842-1AA40

3UG5842-2AA40

Accessories, see page 10/110.

For AC active currents $I_{res} > 10$ A it is possible to use 4NC current transformers as an accessory, see Catalog LV 10.

NEW

Residual current monitoring > Residual current monitoring relays

Overview

SIRIUS 3UG5625 monitoring relay

The 3UG5625 residual current monitoring relays are used in conjunction with the 3UL23 residual-current transformers for monitoring plants in which higher residual currents are increasingly expected due to ambient conditions.

Monitoring encompasses pure AC residual currents or AC residual currents with a pulsating DC fault current component (transformer, type A according to DIN VDE 0100-530/IEC TR 60755).

The 3UG5825 device is available as a version for IO-Link.

Benefits

- Worldwide use thanks to wide voltage range from 24 to 240 V AC/DC
- High measurement accuracy of $\pm 7.5\%$
- Permanent self-monitoring
- Variable threshold values for warning and disconnection
- Freely configurable delay times and RESET response
- Permanent display of the actual value and fault diagnostics via the display
- High level of flexibility and space saving through installation of the transformer inside or outside the control cabinet
- Communication via IO-Link with the SIRIUS 3UG5825 relay as well as display and transmission of actual values and diagnostics to the controller
- Width 22.5 mm
- All versions with removable terminals
- All versions with screw or spring-loaded terminals (push-in)

Application

Monitoring of plants in which residual currents can occur, e.g. due to dust deposits or moisture, porous cables and leads, or capacitive residual currents.



Monitoring and control devices

Relays

SIRIUS 3UG5 monitoring relays for stand-alone installation

Residual current monitoring > Residual current monitoring relays **NEW**

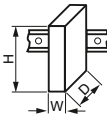
Technical specifications

More information			
Technical specifications, see https://support.industry.siemens.com/cs/ww/en/ps/25412/td		Equipment Manual, see https://support.industry.siemens.com/cs/ww/en/view/109814940 FAQs, see https://support.industry.siemens.com/cs/ww/en/ps/25412/faq	
Article number		3UG5625-CW30	3UG5825-AA40
General data			
Width x height x depth		mm	22.5 x 100 x 90
Ambient temperature		°C	-25 ... +60
• During operation		°C	-40 ... +80
• During storage		°C	-40 ... +80
• During transport		°C	-40 ... +80
Degree of protection IP			IP20
Mounting position			Any
Installation altitude at height above sea level, maximum	m		2 000
Electrical endurance (operating cycles) for AC-15 at 230 V typical			100 000
Mechanical endurance (operating cycles), typical			10 000 000
Adjustable ON-delay time			
• On starting	s		0 ... 999.9
Vibration resistance according to IEC 60068-2-6			$f = 4 \dots 5.81 \text{ Hz}$, $d_{\text{max}} = 15 \text{ mm}$; $f = 5.81 \dots 500 \text{ Hz}$, $A_{\text{max}} = 20 \text{ m/s}^2$; 10 cycles
Shock resistance according to IEC 60068-2-27	g/ms		Half-sine wave 15/11
Electromagnetic compatibility			IEC 60947-1/IEC 61000-6-2/IEC 61000-6-4
Electrical separation between input and output			Yes
Type of electrical separation			Electrical separation
Insulation voltage for overvoltage category III according to IEC 60664			
• For pollution degree 2	V		690
• For pollution degree 3	V		690
Product function			
• Automatic RESET			Yes
• Manual RESET			Yes
IO-Link protocol is supported			No
			Yes
Measuring circuit			
Measurable line frequency	Hz		16 ... 400
Adjustable current response value			
• 1	A		0.03 ... 40
• 2	A		0.03 ... 40
Control circuit			
Number of CO contacts with delayed switching		2	1
Thermal current of the non-solid-state contact blocks, maximum	A		5
Current-carrying capacity of the output relay			
• At AC-15 at 400 V at 50/60 Hz	A		3
• At DC-13			
- At 24 V	A		1
- At 125 V	A		0.2
- At 250 V	A		0.1
Operational current at 17 V, minimum	mA		5
Article number		3UG5625-1...0, 3UG5825-1...0	3UG5625-2...0, 3UG5825-2...0
Type of electrical connection		 Screw terminals	 Spring-loaded terminals (push-in)
Tightening torque		0.6 ... 0.8 Nm	--
Type of connectable conductor cross-sections			
• Solid		1 x (0.5 ... 4 mm ²), 2 x (0.5 ... 2.5 mm ²)	1 x (0.5 ... 4 mm ²)
• Finely stranded		--	1 x (0.5 ... 4 mm ²)
- Without end sleeve		1 x (0.5 ... 4 mm ²), 2 x (0.5 ... 2.5 mm ²)	1 x (0.5 ... 2.5 mm ²)
- With end sleeve		--	--
• For AWG cables			
- Solid		1 x (20 ... 12), 2 x (20 ... 14)	1 x (20 ... 12)
- Stranded		--	1 x (20 ... 12)

NEW Residual current monitoring > Residual current monitoring relays

3UG4625 and 3UG4825 monitoring relays

The main conductor, and any neutral conductor to which a load is connected, are routed through the opening of the toroidal core of a residual-current transformer. A secondary winding is placed around this toroidal core to which the monitoring relay is connected.

If operation of a plant is fault-free, the sum of the inflowing and outward currents equals zero. No current is then induced in the secondary winding of the residual-current transformer.

However, if an insulation fault occurs, the sum of the inflowing currents is greater than that of the outward currents. The differential current – i.e. the residual current – induces a secondary current in the secondary winding of the transformer. This current is evaluated in the monitoring relay and is used on the one hand to display the actual residual current and on the other, to switch the relay if the set warning or tripping threshold is overshoot.

With the closed-circuit principle selected

Residual current monitoring with automatic RESET for 3UG5625

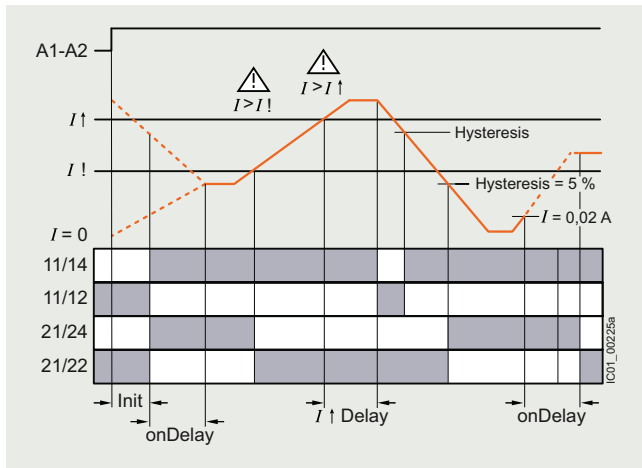

The 3UG5625 monitoring relays can be operated based on either the open-circuit or closed-circuit principle and with manual or automatic RESET.

Residual current monitoring with manual RESET for 3UG5625

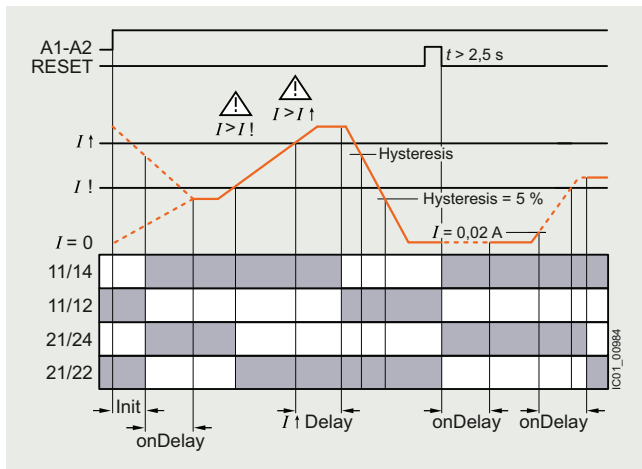

If the measured residual current exceeds the set warning value, the associated changeover contact instantly changes the switching state and an indication appears on the display.

If the measured residual current exceeds the set tripping value, the set delay time begins and the relay symbol flashes on the display. On expiry of this time, the associated changeover contact changes the switching state.

ON-delay time for motor start

To be able to start a drive when a residual current is detected, the output relays switch to the OK state for an adjustable ON-delay time depending on the selected open-circuit principle or closed-circuit principle.

The changeover contacts do not react if the set threshold values are overshoot during this period.

Residual current monitoring with automatic RESET for 3UG5825

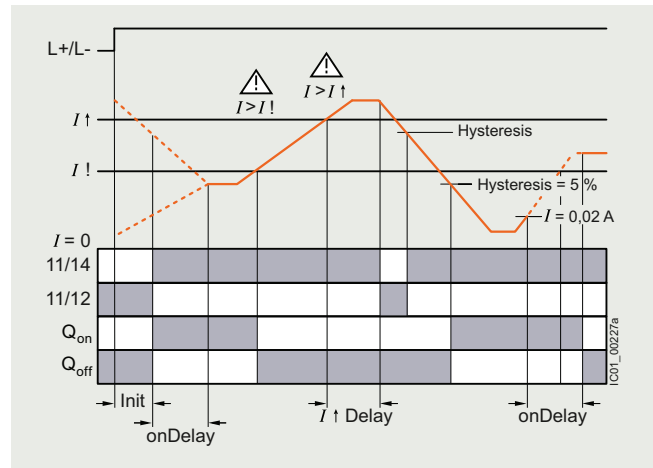

The 3UG5825 monitoring relays can be operated based on either the open-circuit or closed-circuit principle and with manual or automatic RESET.

Residual current monitoring with manual RESET for 3UG5825

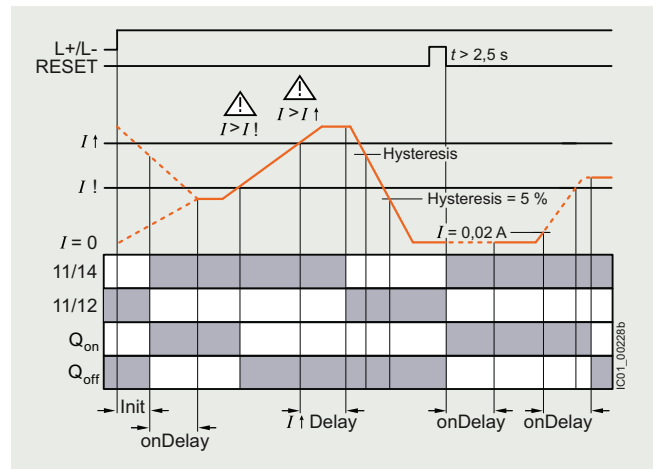

Monitoring and control devices

Relays

SIRIUS 3UG5 monitoring relays for stand-alone installation



Residual current monitoring > Residual current monitoring relays **NEW**

If manual RESET is selected in the menu, the 3UG5825 switching relay or the 3UG5625 switching relay remains in its current switching state and the current measured value and the symbol for undershooting and overshooting continues to be displayed, even when the measured variable reaches a permissible value again. This stored fault condition can be reset by pressing the Back key and confirming with the Enter key.

Note:

The neutral conductor must not be grounded downstream of the summation current transformer as this may impair the function of the residual current monitoring device.

Selection and ordering data

PU (UNIT, SET, M) = 1
 PS* = 1 unit
 PG = 41H

Multi-unit packaging, see page 16/7.



3UG5625-1CW30



3UG5625-2CW30

Measurable current mA	Control supply voltage at AC		at DC	Number of CO contacts with delayed switching	Screw terminals		Spring-loaded terminals (push-in)	
	at 50 Hz	at 60 Hz	V		Article No.	Price per PU	Article No.	Price per PU
30 ... 40 000	24 ... 240	24 ... 240	24 ... 240	2	3UG5625-1CW30		3UG5625-2CW30	
• For IO-Link								
30 ... 40 000	--	--	24	1	3UG5825-1AA40		3UG5825-2AA40	

Digitally adjustable residual current monitoring relays

Monitoring of residual current, external power supply with auxiliary voltage

30 ... 40 000	24 ... 240	24 ... 240	24 ... 240	2
• For IO-Link				
30 ... 40 000	--	--	24	1

Accessories, see page 10/110.

For the 3UL23 residual-current transformers, see page 10/101.

Overview



SIRIUS 3UL23 residual-current transformer

The 3UL23 residual-current transformers detect residual currents in machines and plants. They are suitable for pure AC residual currents or AC residual currents with a pulsating DC fault current component (transformer type A according to DIN VDE 0100-530/IEC TR 60755).

Residual current and ground fault monitoring is possible in conjunction with the 3UG5625 residual current monitoring relay, the 3UG5825 residual current monitoring relay (for IO-Link) or the SIMOCODE 3UF motor management and control unit.

The 3UL2302-1A and 3UL2303-1A residual-current transformers with a feed-through opening of 35 and 55 mm can be mounted in conjunction with the 3UL2900 accessories on a TH 35 DIN rail according to IEC 60715.

Selection and ordering data

Diameter of the feed-through opening	Measurable current	Connectable cross-section of the connecting terminal	Screw terminals	PU (UNIT, SET, M)	PS*	PG
mm	A	mm ²	Article No.	Price per PU		
Residual-current transformers (essential accessories for 3UG5625, 3UG5825 and 3UF75, 3UF76 and 3UF80)						
35	0.03 ... 40	2.5	3UL2302-1A	1	1 unit	41H
55	0.03 ... 40	2.5	3UL2303-1A	1	1 unit	41H
80	0.03 ... 40	2.5	3UL2304-1A	1	1 unit	41H
105	0.03 ... 40	2.5	3UL2305-1A	1	1 unit	41H
140	0.03 ... 40	2.5	3UL2306-1A	1	1 unit	41H
210	0.03 ... 40	4	3UL2307-1A	1	1 unit	41H

Accessories

Application	Article No.	Price per PU	PU (UNIT, SET, M)	PS*	PG
Adapters					
 For mounting on DIN rail for 3UL23 up to diameter 55 mm	3UL2900		1	1 unit	41H

3UL2900

Monitoring and control devices

Relays

SIRIUS 3UG5 monitoring relays for stand-alone installation

Level monitoring **NEW**

Overview



SIRIUS 3UG5501 monitoring relay

The 3UG5501 level monitoring relay is used in combination with 2-pole or 3-pole sensors to monitor the levels of conductive liquids.

The 3UG5501 relay is available as a version with SIL 1/PL c.

Benefits

- Can be used worldwide thanks to wide voltage range from 24 to 240 V
- Individually shortenable 2- and 3-pole wire electrodes for easy mounting from above/below
- Bow electrodes for installation from the side, for larger filling levels and minimum space requirements
- Can be flexibly adapted to different conductive liquids through analog setting of the sensitivity from 0.5 to 500 k Ω
- Compensation for wave movements through tripping delay times from 0.5 to 30 s
- Inflow or outflow function can be selected
- Devices with Safety certification according to SIL 1/PL c
- Width 22.5 mm
- All versions with removable terminals
- All versions with screw or spring-loaded terminals (push-in)

Application

- Single-point and two-point level monitoring
- Overflow protection
- Dry-running protection
- Leak monitoring
- Applications according to the German Water Resources Act

Technical specifications

More information

Technical specifications, see
<https://support.industry.siemens.com/cs/ww/en/ps/25412/td>

Equipment Manual, see
<https://support.industry.siemens.com/cs/ww/en/view/109814940>
 FAQs, see <https://support.industry.siemens.com/cs/ww/en/ps/25412/faq>

Article number

3UG5501-AW30**3UG5501-AW31**

General data

Width x height x depth

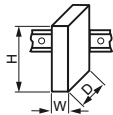

mm

22.5 x 100 x 90

Ambient temperature

• During operation	°C	-25 ... +60
• During storage	°C	-40 ... +80
• During transport	°C	-40 ... +80

Degree of protection IP

IP20

Mounting position

Any

Installation altitude at height above sea level, maximum

m

2 000

Electrical endurance (operating cycles) for AC-15 at 230 V typical

100 000

Mechanical endurance (operating cycles), typical

10 000 000

Adjustable ON-delay time on upper or lower limit violation

s

0.5 ... 30

Performance Level (PL) according to ISO 13849-1

--

PL c

Safety Integrity Level (SIL) according to IEC 62061

--

SIL 1

Vibration resistance according to IEC 60068-2-6

 $f = 4 \dots 5.81 \text{ Hz}$, $d_{\text{max}} = 15 \text{ mm}$; $f = 5.81 \dots 500 \text{ Hz}$, $A_{\text{max}} = 20 \text{ m/s}^2$; 10 cycles

Shock resistance according to IEC 60068-2-27

g/ms

Half-sine wave 15/11

Electromagnetic compatibility

IEC 60947-1/IEC 61000-6-2/IEC 61000-6-4

Electrical separation between input and output

Yes

Insulation voltage for overvoltage category III according to IEC 60664

• For pollution degree 3

V

300

Impulse withstand voltage

kV

6

Measuring circuit

Measuring electrode voltage, maximum

V

3.5

Control circuit

Number of CO contacts with delayed switching

1

Thermal current of the non-solid-state contact blocks, maximum

A

5

Current-carrying capacity of the output relay

• At AC-15 at 400 V at 50/60 Hz

A

3

• At DC-13

- At 24 V

A

1

- At 125 V

A

0.2

- At 250 V

A

0.1

Operational current at 17 V, minimum

mA

5

Article number

3UG5501-1AW3.**3UG5501-2AW3.**

Type of electrical connection



Screw terminals



Spring-loaded terminals (push-in)

Tightening torque

0.6 ... 0.8 Nm

--

Type of connectable conductor cross-sections

• Solid

1 x (0.5 ... 4 mm²), 2 x (0.5 ... 2.5 mm²)1 x (0.5 ... 4 mm²)

• Finely stranded

- Without end sleeve

--

1 x (0.5 ... 4 mm²)

- With end sleeve

1 x (0.5 ... 4 mm²), 2 x (0.5 ... 2.5 mm²)1 x (0.5 ... 2.5 mm²)

• For AWG cables

- Solid

1 x (20 ... 12), 2 x (20 ... 14)

1 x (20 ... 12)

- Stranded

--

1 x (20 ... 12)

Monitoring and control devices

Relays

SIRIUS 3UG5 monitoring relays for stand-alone installation

Level monitoring **NEW**

3UG5501 monitoring relays

The principle of operation of the 3UG5501 level monitoring relay is based on measuring the electrical resistance of the liquid between two immersion sensors and a reference terminal. If the measured value is lower than the sensitivity set on the front, the output relay changes its switching state. In order to preclude active current undershooting of the liquid, the sensors are supplied with alternating current.

The level monitoring relay is also available as a version with SIL 1/PL c certification and for inflow control according to the German Water Resources Act (WHG). With these devices, it is possible to use sensors with an internal parallel resistor both to monitor the connection to the sensor and to detect a cable break.

Two-point control

The output relay changes its switching state as soon as the liquid level reaches the maximum sensor, while the minimum sensor is submerged. The relay returns to its original switching state as soon as the minimum sensor no longer has contact with the liquid.

Outflow control, two-point control

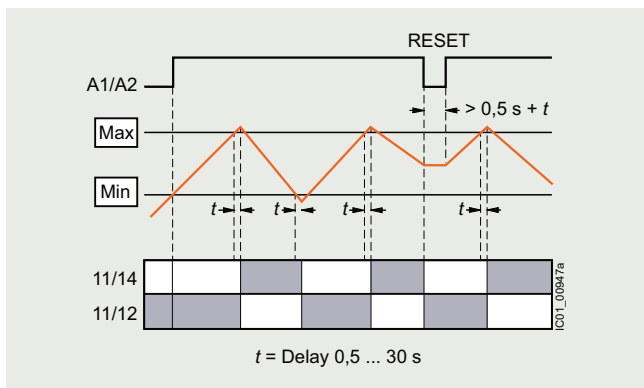

Inflow control, two-point control

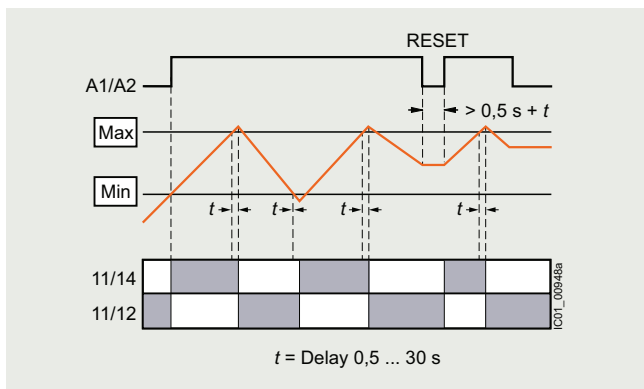

Note:

It is also possible to connect other resistance sensors to the Min and Max terminals in the range 0.5 to 500 kΩ, e.g. photoresistors, temperature sensors, encoders based on resistance, etc. The monitoring relay can therefore also be used for other applications as well as for monitoring the levels of liquids.

Single-point control

If only one level is being controlled, the terminals for Min and Max on the monitoring relay are bridged. The output relay changes its switching state as soon as the liquid level is reached and returns to its original switching state once the sensor no longer has contact with the liquid.

In order to prevent premature tripping of the switching function caused by wave motion or frothing, even though the set level has not been reached, it is possible to delay this function by 0.5 to 30 s.

For safe resetting, the control supply voltage must be interrupted for at least the set delay time of +0.5 s.

Outflow control, single-point control

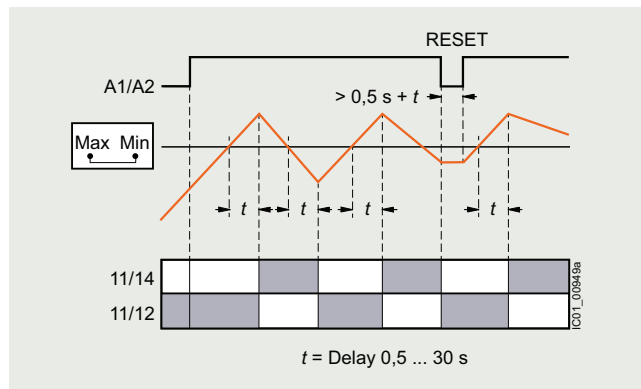

Inflow control, single-point control

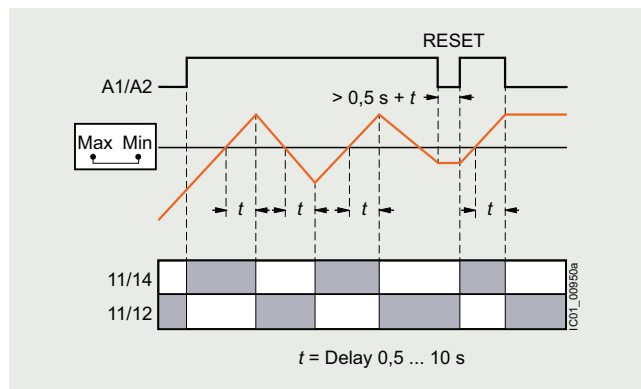

In the WHG (German Water Resources Act) monitoring type, only single-point control is possible.

Single-point control for monitoring type WHG

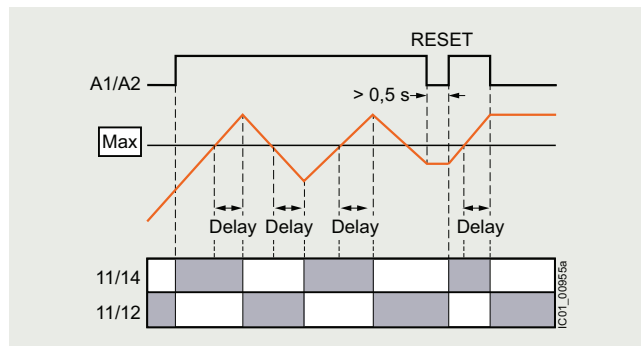

Selection and ordering data

PU (UNIT, SET, M) = 1
 PS* = 1 unit
 PG = 41H



Multi-unit packaging, see page 16/7.



3UG5501-1AW30



3UG5501-2AW30

Control supply voltage			Number of CO contacts with delayed switching	Screw terminals 		Spring-loaded terminals (push-in) 	
at AC	at 50 Hz	at 60 Hz		at DC	Article No.	Price per PU	Article No.
V	V	V	V				

Analogically adjustable level monitoring relays**Monitoring of level, external power supply with auxiliary voltage**

24 ... 240	24 ... 240	24 ... 240	1
• For safety applications			
24 ... 240	24 ... 240	24 ... 240	1

3UG5501-1AW30

3UG5501-2AW30

3UG5501-1AW31

3UG5501-2AW31

Accessories, see page 10/110.

Note:

Sensors must be used to apply the devices according to WHG (German Water Resources Act), see [Accessories](#). For the Safety versions, it is necessary to use sensors with a parallel resistor. We recommend use of our sensors.

Accessories

Version	Article No.	Price per PU	PU (UNIT, SET, M)	PS*	PG
Level monitoring sensors (essential accessory)					
The wire electrodes can be cut or bent to the required length before or after installation. The Teflon insulation must be removed over a length of approx. 5 mm.					
3-pole wire electrode, 500 mm long For 2-point liquid level control in an insulating tank. One electrode each for the minimum and maximum value and a common reference electrode.	3UG5207-3F		1	1 unit	41H
2-pole wire electrode, 500 mm long For alarm indication in the event of overflow or low level and for 2-point liquid level control, when the conductive tank is used as the reference electrode.	3UG5207-2F		1	1 unit	41H
2-pole bow electrode for lateral fitting Thanks to the small space requirements due to lateral fitting, ideal for use in small containers and pipes, as a leak monitor and level monitor or for warning of water entering an enclosure.	3UG5207-2G		1	1 unit	41H
1-pole bow electrode for lateral fitting As maximum value electrode for lateral mounting or for alarm signaling in electrically conductive tanks or pipes.	3UG5207-1G		1	1 unit	41H
1-pole rod electrodes for lateral fitting For high flow velocities or for intensively sparkling fluids.	3UG5207-1H		1	1 unit	41H

3UG5207-3F

3UG5207-2F

3UG5207-2G

3UG5207-1G

3UG5207-1H

Monitoring and control devices

Relays

SIRIUS 3UG5 monitoring relays for stand-alone installation

Speed monitoring **NEW**

Overview



SIRIUS 3UG5651 monitoring relay

The 3UG5651 monitoring relay is used in combination with a sensor to monitor motor drives for overspeed and/or underspeed.

Furthermore, the monitoring relay is ideal for all functions where a continuous pulse signal needs to be monitored (e.g. belt travel monitoring, completeness monitoring, passing monitoring, clock-time monitoring).

The 3UG5851 device is available as a version for IO-Link. Moreover, there is a 3UG5651 version with SIL 1/PL c.



Benefits

- Can be used worldwide thanks to wide voltage range from 24 to 240 V
- Variably adjustable to overshoot, undershoot or range monitoring
- Freely configurable delay times and RESET response
- Permanent display of actual value and fault type
- Use of up to 10 sensors per rotation for extremely slowly rotating motors
- Two-wire or three-wire sensors and sensors with a mechanical switching output or solid-state output can be connected
- Auxiliary voltage for sensor integrated
- Devices with Safety certification according to SIL 1/PL c
- Communication via IO-Link with the SIRIUS 3UG5851 relay as well as display and transmission of actual values and diagnostics to the controller
- Width 22.5 mm
- All versions with removable terminals
- All versions with screw or spring-loaded terminals (push-in)

Application

- Slip or tear of a belt drive
- Overload monitoring
- Transport monitoring for completeness

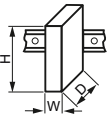
Technical specifications

More information	
Technical specifications, see https://support.industry.siemens.com/cs/ww/en/ps/25412/td	Equipment Manual, see https://support.industry.siemens.com/cs/ww/en/view/109814940 FAQs, see https://support.industry.siemens.com/cs/ww/en/ps/25412/faq
Article number	3UG5651-CW30 3UG5651-CW31 3UG5851-AA40
General data	
Width x height x depth	 mm 22.5 x 100 x 90
Ambient temperature	
• During operation	°C -25 ... +60
• During storage	°C -40 ... +80
• During transport	°C -40 ... +80
Degree of protection IP	IP20
Mounting position	Any
Installation altitude at height above sea level, maximum	m 2 000
Electrical endurance (operating cycles) for AC-15 at 230 V typical	100 000
Mechanical endurance (operating cycles), typical	10 000 000
Adjustable ON-delay time	
• On starting	s 0 ... 999.9
• On upper or lower limit violation	s 0 ... 999.9
Vibration resistance according to IEC 60068-2-6	$f = 4 \dots 5.81 \text{ Hz}$, $d_{\text{max}} = 15 \text{ mm}$; $f = 5.81 \dots 500 \text{ Hz}$, $A_{\text{max}} = 20 \text{ m/s}^2$; 10 cycles
Shock resistance according to IEC 60068-2-27	g/ms Half-sine wave 15/11
Electromagnetic compatibility	IEC 60947-1/IEC 61000-6-2/IEC 61000-6-4
Performance Level (PL) according to ISO 13849-1	-- PL c --
Safety Integrity Level (SIL) according to IEC 62061	-- SIL 1 --
Electrical separation between input and output	Yes
IO-Link protocol is supported	No Yes
Measuring circuit	
Input current at digital input 1, maximum	mA -- 50
Control circuit	
Number of CO contacts with delayed switching	2 1
Thermal current of the non-solid-state contact blocks, maximum	A 5
Current-carrying capacity of the output relay	
• At AC-15 at 400 V at 50/60 Hz	A 3
• At DC-13	
- At 24 V	A 1
- At 125 V	A 0.2
- At 250 V	A 0.1
Operational current at 17 V, minimum	mA 5
Article number	3UG5651-1...., 3UG5851-1.... 3UG5651-2...., 3UG5851-2....
Type of electrical connection	 Screw terminals  Spring-loaded terminals (push-in)
Tightening torque	0.6 ... 0.8 Nm --
Type of connectable conductor cross-sections	
• Solid	1 x (0.5 ... 4 mm ²), 2 x (0.5 ... 2.5 mm ²) --
• Finely stranded	--
- Without end sleeve	1 x (0.5 ... 4 mm ²), 2 x (0.5 ... 2.5 mm ²) 1 x (0.5 ... 4 mm ²)
- With end sleeve	1 x (0.5 ... 4 mm ²), 2 x (0.5 ... 2.5 mm ²) 1 x (0.5 ... 2.5 mm ²)
• For AWG cables	
- Solid	1 x (20 ... 12), 2 x (20 ... 14) 1 x (20 ... 12)
- Stranded	-- 1 x (20 ... 12)

Monitoring and control devices

Relays

SIRIUS 3UG5 monitoring relays for stand-alone installation

Speed monitoring **NEW**

3UG5651 and 3UG5851 monitoring relays

The speed monitoring relay operates according to the principle of period duration measurement.

In the monitoring relay, the time between two successive rising edges of the pulse encoder is measured and compared to the minimum and/or maximum permissible period duration calculated from the set limit values for the speed.

Thus, the period duration measurement recognizes any deviation in speed after just two pulses, even at very low speeds or in the case of extended pulse gaps.

By using up to ten pulse encoders evenly distributed around the circumference, it is possible to shorten the period duration, and in turn the response time. By taking into account the number of sensors in the monitoring relay, the speed continues to be indicated in revolutions per minute.

It is also possible to implement the function of a meter with the relay.

ON-delay time for motor start

To be able to start a motor drive, and depending on whether the open-circuit or closed-circuit principle is selected, the output

relay switches to the OK state during the ON-delay time, even if the speed is still below the set value.

The ON-delay time is started by either switching on the auxiliary voltage or, if the auxiliary voltage is already applied, by actuating the respective NC contact (e.g. auxiliary contact).

Speed monitoring with automatic RESET (Reset = AUTO)

If the device is set to automatic RESET, the output relay switches to the OK state, once the adjustable hysteresis threshold is reached in the range of 0.1 to 99.9 rpm and the flashing stops. Any overshoots or undershoots are therefore not stored.

Speed monitoring with manual RESET (Reset = Manual)

If manual RESET is selected in the menu, the switching relay remains in its current switching state and the current measured value and the symbol for undershooting and overshooting continue to be displayed, even when the measured variable reaches a permissible value again. This stored fault condition can be reset by pressing the Back key and confirming with the Enter key.

The device is also available as a version with SIL 1/PL c certification.

With the closed-circuit principle selected

Range monitoring without enable input for 3UG5651

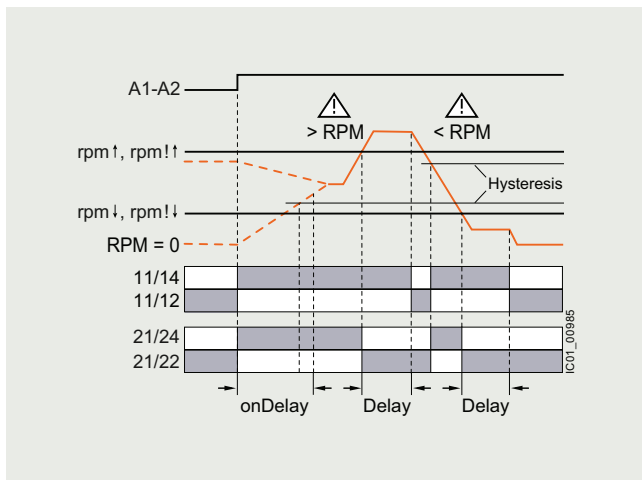

Range monitoring with enable input for 3UG5651

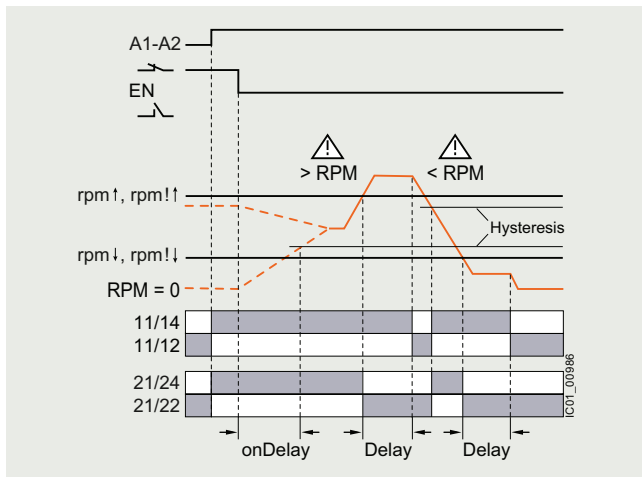

Range monitoring without enable input for 3UG5851

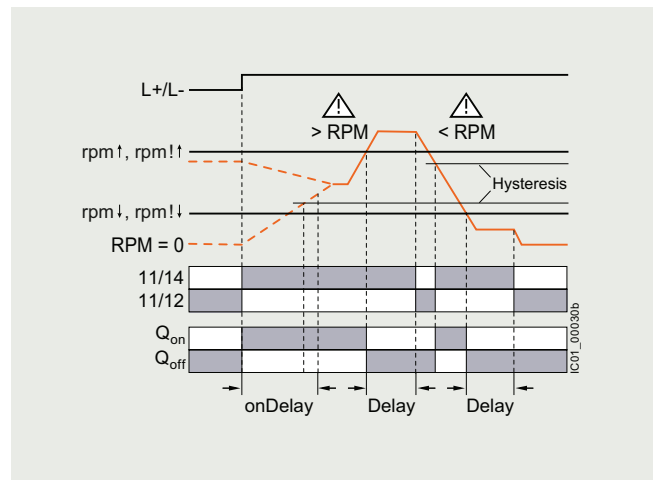

Range monitoring with enable input for 3UG5851

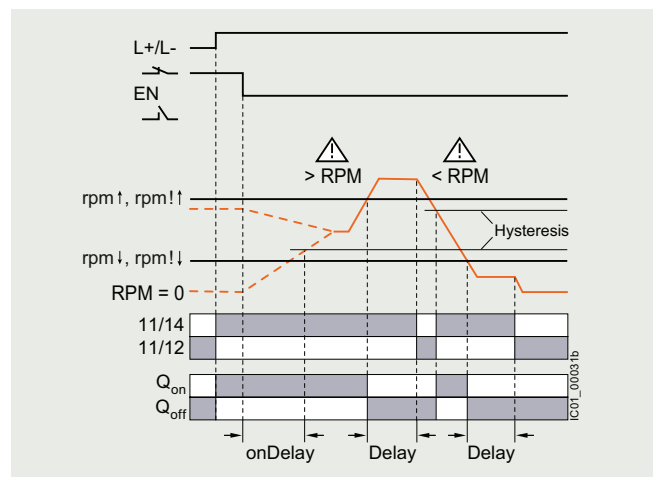

Selection and ordering data

PU (UNIT, SET, M) = 1
 PS* = 1 unit
 PG = 41H



Multi-unit packaging,
 see page 16/7.



3UG5651-1CW30



3UG5651-2CW30

Control supply voltage			Number of CO contacts with delayed switching	Screw terminals 		Spring-loaded terminals (push-in) 	
at AC at 50 Hz	at 60 Hz	at DC		Article No.	Price per PU	Article No.	Price per PU
V	V	V					

Digitally adjustable speed monitoring relays
Monitoring of speed, external power supply with auxiliary voltage

24 ... 240	24 ... 240	24 ... 240	2
• For safety applications			
24 ... 240	24 ... 240	24 ... 240	2
• For IO-Link			
--	--	24	1

3UG5651-1CW30

3UG5651-2CW30

3UG5651-1CW31

3UG5651-2CW31

3UG5851-1AA40

3UG5851-2AA40

Accessories, see page 10/110.













Monitoring and control devices

Relays

SIRIUS 3UG5 monitoring relays for stand-alone installation

Accessories

Selection and ordering data

Version	Article No.	Price per PU	PU (UNIT, SET, M)	PS*	PG
Terminals for SIRIUS devices in the industrial DIN-rail enclosure					
 <p>3ZY1122-1BA00</p> <p>Removable terminals, without inscription</p> <ul style="list-style-type: none"> • 2-pole, up to 1 x 4 mm² or 2 x 2.5 mm² 	<p>Screw terminals </p> <p>3ZY1122-1BA00</p>		1	6 units	41L
 <p>3ZY1122-2BA00</p> <p>Removable terminals, without inscription</p> <ul style="list-style-type: none"> • 2-pole, up to 1 x 4 mm² or 2 x 1.5 mm² (in shared end sleeve) 	<p>Spring-loaded terminals (push-in) </p> <p>3ZY1122-2BA00</p>		1	6 units	41L
Accessories for enclosures					
 <p>3ZY1311-0AA00</p> <p>Push-in lugs for wall mounting (Two lugs are required per device)</p>	<p>3ZY1311-0AA00</p>		1	10 units	41L
 <p>3ZY1440-1AA00</p> <p>Coding pins For removable terminals of SIRIUS devices in the industrial DIN-rail enclosure; enable the mechanical coding of terminals</p>	<p>3ZY1440-1AA00</p>		1	12 units	41L
 <p>3ZY1450-1AB00</p> <p>Hinged covers Replacement covers, without terminal labeling, titanium gray</p> <ul style="list-style-type: none"> • 22.5 mm wide 	<p>3ZY1450-1AB00</p>		1	5 units	41L
 <p>3ZY1450-1AB00</p> <p>Sealable covers Replacement covers, without terminal labeling, titanium gray</p> <ul style="list-style-type: none"> • 22.5 mm wide 	<p>3ZY1321-2AA00</p>		1	5 units	41L
 <p>3ZY1321-2AA00</p> <p>Push-in lugs For screw fixing, 2 units are required for each device</p>	<p>3RP1903</p>		1	10 units	41H
Blank labels					
 <p>3RP1903</p> <p>Unit labeling plates¹⁾ For SIRIUS devices</p> <ul style="list-style-type: none"> • 20 mm x 7 mm, titanium gray 	<p>3RT2900-1SB20</p>		100	340 units	41B
Tools for opening spring-loaded terminals					
 <p>3RA2908-1A</p> <p>Screwdriver For all SIRIUS devices with spring-loaded terminals</p> <p>Length approx. 200 mm, 3.0 mm x 0.5 mm, titanium gray/black, partially insulated</p>	<p>Spring-loaded terminals (push-in) </p> <p>3RA2908-1A</p>		1	1 unit	41B

¹⁾ PC labeling system for individual inscription of unit labeling plates available from: murrplastik Systemtechnik GmbH, see page 16/18.

Note:

For products for mechanical bearing monitoring, e.g. condition monitoring systems, see www.siemens.com/siplus-cms.

Overview



SIRIUS 3UG458 insulation monitors

More information

Homepage, see www.siemens.com/sirius-monitoring-relays
 SiePortal, see www.siemens.com/product_catalog_siep?3UG45
 TIA Selection Tool Cloud (TST Cloud), see www.siemens.com/tstcloud/?node=SIRIUSRelais
 Conversion tool, see www.siemens.com/conversion-tool

Insulation monitoring relays are used for monitoring the insulation resistance between ungrounded 1- or 3-phase AC supplies and a protective conductor.

Ungrounded, i.e. isolated networks (IT networks) are always used where high demands are placed on the reliability of the power supply, e.g. emergency lighting systems. IT systems are supplied via an isolating transformer or by power supply sources such as batteries or a generator. While an initial insulation fault between a phase conductor and the ground effectively grounds the conductor, as a result no circuit has been closed, so it is possible to continue work in safety (single-fault safety). However, the fault must be rectified as quickly as possible before a second insulation fault occurs (e.g. according to DIN VDE 0100-410). For this purpose insulation monitoring relays are used, which constantly measure the resistance to ground of the phase conductor and the neutral conductor, reporting a fault immediately if insulation resistance falls below the set value so that either a controlled shutdown can be performed or the fault can be rectified without interrupting the power supply.

Two device series

- 3UG4581 insulation monitoring relays for ungrounded AC networks
- 3UG4582 and 3UG4583 insulation monitoring relays for ungrounded DC and AC networks

Insulation monitoring for ungrounded AC networks

The 3UG4581 insulation monitoring relays are used to monitor insulation resistance according to IEC 61557-8 in ungrounded AC networks with rated voltages of up to 400 V.

These devices can monitor control circuits (1-phase) and main circuits (3-phase).

They measure insulation resistances between system cables and system ground. If the value falls below the threshold value, the output relays are switched to fault status.

In the case of 3UG4581 a superimposed DC measuring signal is used. The superimposed DC measuring signal and the resulting current are used to determine the value of the insulation resistance of the network which is to be measured.

Insulation monitoring relays for ungrounded DC and AC networks

The 3UG4582 and 3UG4583 insulation monitoring relays are used to monitor insulation resistance in ungrounded IT AC or DC networks according to IEC 61557-8.

They measure insulation resistances between system cables and system ground. If the value falls below the threshold value, the output relays are switched to fault status. With these monitoring relays, which are suitable for both AC and DC networks, a pulsed measuring signal is fed into the network to be monitored and the insulation resistance is determined.

The pulsed measuring signal changes its form according to insulation resistance and network loss capacitance. The changed form is used to predict the changed insulation resistance.

If the predicted insulation resistance matches the insulation resistance calculated in the next measurement cycle, and is lower than the threshold value, the output relays are activated or deactivated, depending on the device configuration. This measurement principle is also suitable for identifying symmetrical insulation faults.

3UG4983 voltage reducer module

3UG4983 voltage reducer module

The 3UG4983-.AA01 voltage reducer module is available for the 3UG4583 insulation monitoring relay to extend the network voltage range to 690 V AC and 1000 V DC.

Connection methods

With the updated enclosure, future-proof push-in technology is available alongside the tried-and-trusted screw terminals.

Push-in is a form of spring-loaded connection system allowing wiring of terminals without tools. These terminals are self-adjusting, i.e. the regular tightening needed with screw terminals is not necessary.

Monitoring and control devices

Relays

SIRIUS 3UG45, 3UG46 monitoring relays for stand-alone installation

Insulation monitoring

Article number scheme

Product versions	Article number
Monitoring relays	3UG4 □ □ □ - □ □ □ □ 1
Type of setting	e.g. 5 = analogically adjustable □
Functions	e.g. 82 = insulation monitoring □ □
Connection type	Screw terminals 1
	Spring-loaded terminals (push-in) 2
Contacts	e.g. A = 1 CO contact □
Supply voltage	e.g. W3 = 24 ... 240 V □ □
Example	3UG4 5 8 2 - 1 A W 3 1

Note:

The article number scheme shows an overview of product versions for better understanding of the logic behind the article numbers.

For your orders, please use the article numbers quoted in the selection and ordering data.

Benefits

- Devices for AC and DC systems
- All devices have a wide control supply voltage range
- Direct connection to networks with line voltages of up to 690 V AC and 1 000 V DC by means of a voltage reducer module
- For AC supply systems: Frequency range 15 to 400 Hz
- Monitoring of broken conductors
- Monitoring of setting errors
- Safety in use thanks to integrated system test after startup
- Option of resetting and testing (by means of button on the front or using control contact)
- New predictive measurement principle allows very fast response times
- All versions with screw or spring-loaded terminals with push-in functionality

Application

IT networks are used, for example:



- In emergency power supplies
- In safety lighting systems
- In industrial production plants with high availability requirements (chemical industry, automobile manufacture, printing)
- In shipping and railways
- For mobile generators (aircraft)
- For renewable energies, such as wind energy and photovoltaic power plants
- In the mining industry

Technical specifications

More information

For equipment manuals, see

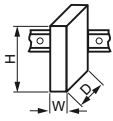
- <https://support.industry.siemens.com/cs/ww/en/view/54382552>
- <https://support.industry.siemens.com/cs/ww/en/view/54382528>

Article number		3UG4581-.AW31	3UG4582-.AW31	3UG4583-.CW31	3UG4983-.AA01
General data					
Dimensions (W x H x D)	 mm	22.5 x 78 x 100		45 x 78 x 100	
Degree of protection IP on the front according to IEC 60529		IP20			
Mounting position		Any			
Type of mounting		Snap-on mounting on 35 mm DIN-rail			
Ambient temperature during operation	°C	-25 ... +60			
Fault storage		Yes			No
Measuring circuit					
Measurable voltage					
• At AC	V	0 ... 400	0 ... 250	0 ... 400	0 ... 690
• At DC	V	--	0 ... 300	0 ... 600	0 ... 1 000
Measurable line frequency	Hz	50 ... 60	15 ... 400		
Adjustable response value impedance					
• 1	kΩ	1 ... 100			--
• 2	kΩ	--	2 ... 200		--
System leakage capacitance	mF	10	20		
Control circuit					
Control supply voltage					
• At AC					
- At 50 Hz	V	24 ... 240			--
- At 60 Hz	V	24 ... 240			--
• At DC	V	24 ... 240			--
Operating frequency	Hz	50 ... 60	15 ... 400		
Impulse withstand voltage	V	6 000		4 000	8 000
Number of CO contacts with delayed switching		1		2	0
Thermal current of the non-solid-state contact blocks, maximum	A	4			--
Electrical connection					
Article number		3UG4581-1AW31, 3UG4582-1AW31, 3UG4583-1CW31, 3UG4983-1AA01		3UG4581-2AW31, 3UG4582-2AW31, 3UG4583-2CW31, 3UG4983-2AA01	
Type of electrical connection		 Screw terminals		 Spring-loaded terminals (push-in)	
Tightening torque		0.6 ... 0.8 Nm		--	
Type of connectable conductor cross-sections					
• Solid		1 x (0.5 ... 4 mm ²), 2 x (0.5 ... 2.5 mm ²)		2 x (0.5 ... 1.5 mm ²)	
• Finely stranded		1 x (0.5 ... 2.5 mm ²), 2 x (0.5 ... 1.5 mm ²)		2 x (0.5 ... 1.5 mm ²)	
- Without end sleeve		1 x (0.5 ... 2.5 mm ²), 2 x (0.5 ... 1.5 mm ²)		2 x (0.5 ... 1.5 mm ²)	
- With end sleeve		1 x (0.5 ... 2.5 mm ²), 2 x (0.5 ... 1.5 mm ²)		2 x (0.5 ... 1.5 mm ²)	
• For AWG cables		1 x (20 ... 12), 2 x (20 ... 14)		2 x (20 ... 16)	
- Solid		1 x (18 ... 14), 2 x (18 ... 16)		2 x (18 ... 16)	
- Stranded					

Monitoring and control devices

Relays

SIRIUS 3UG45, 3UG46 monitoring relays for stand-alone installation

Insulation monitoring

With the closed-circuit principle selected

- Insulation resistance monitoring without fault storage, with automatic RESET

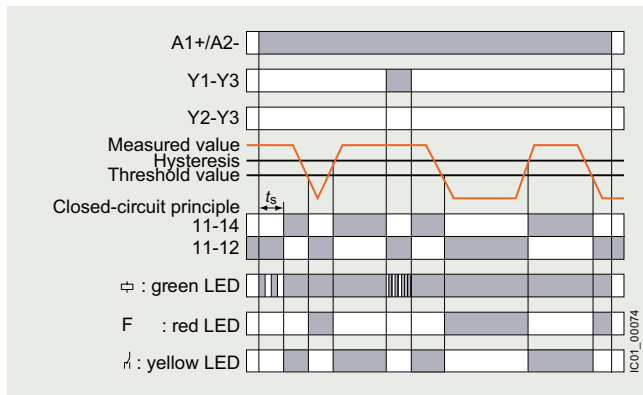

3UG4581, 3UG4582 monitoring relays

- Insulation resistance monitoring with fault storage and manual RESET

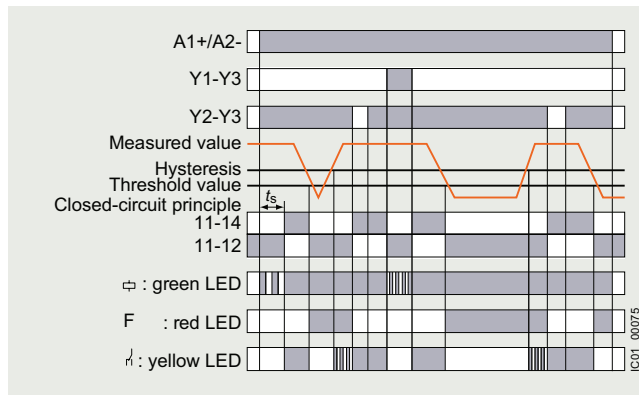

3UG4581, 3UG4582 monitoring relays

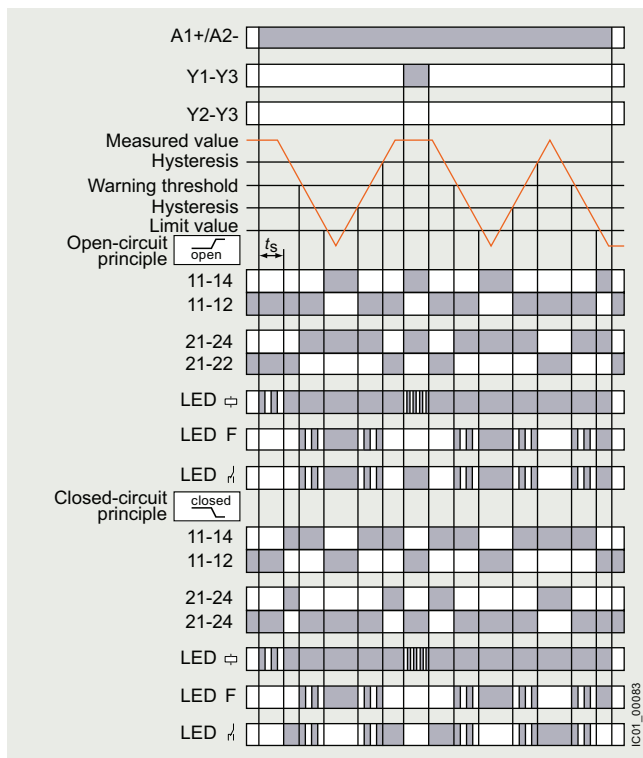

3UG4583 monitoring relays

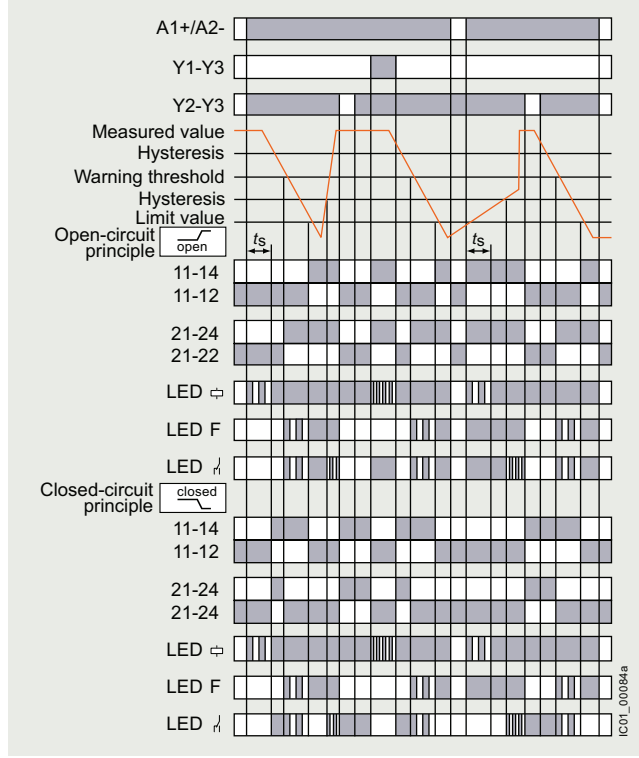

3UG4583 monitoring relays

Selection and ordering data

PU (UNIT, SET, M) = 1
 PS* = 1 unit
 PG = 41H



3UG4581-1AW31



3UG4582-1AW31



3UG4583-1CW31



3UG4983-1AA01

Measurable voltage		Control supply voltage			System leakage capacitance	Number of CO contacts with delayed switching	Adjustable response value impedance		Screw terminals	Spring-loaded terminals (push-in)	
at AC	at DC	at AC at 50 Hz	at 60 Hz	at DC			1	2			
V	V	V	V	V	μF	kΩ	kΩ	Article No.	Price per PU	Article No.	Price per PU
Insulation monitors											
0 ... 400	--	24 ... 240	24 ... 240	24 ... 240	10	1	1 ... 100	--	3UG4581-1AW31	3UG4581-2AW31	
0 ... 250	0 ... 300	24 ... 240	24 ... 240	24 ... 240	10	1	1 ... 100	--	3UG4582-1AW31	3UG4582-2AW31	
0 ... 400	0 ... 600	24 ... 240	24 ... 240	24 ... 240	20	2	1 ... 100	2 ... 200	3UG4583-1CW31	3UG4583-2CW31	
Voltage reducer modules											
For the 3UG4583 insulation monitoring relay for extending the network voltage range to 690 V AC and 1000 V DC											
0 ... 690	0 ... 1 000	--	--	--	20	0	--	--	3UG4983-1AA01	3UG4983-2AA01	

Accessories

Use	Version	Spring-loaded terminals (push-in)	PU (UNIT, SET, M)	PS*	PG
		Article No.	Price per PU		

Tools for opening spring-loaded terminals



3RA2908-1A

Screwdrivers
 For auxiliary circuit connections
 For all SIRIUS devices with spring-loaded terminals

Length approx. 200 mm,
 3.0 mm x 0.5 mm,
 titanium gray/black,
 partially insulated

3RA2908-1A

1 1 unit 41B

Monitoring and control devices

Relays

SIRIUS 3RS2 temperature monitoring relays

General data

Overview

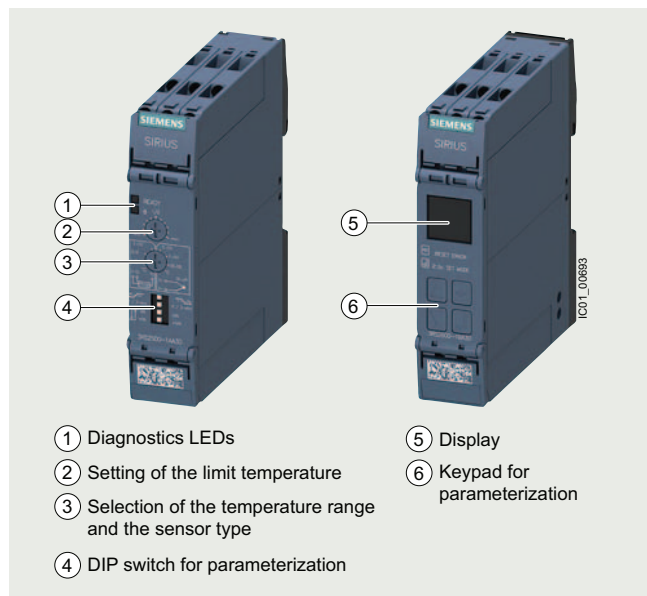

SIRIUS 3RS2 temperature monitoring relays

More information

Homepage, see www.siemens.com/sirius-monitoring-relays

SiePortal, see www.siemens.com/product_catalog_siep?3RS2

TIA Selection Tool Cloud (TST Cloud), see www.siemens.com/tstcloud/?node=SIRIUSRelais

Conversion tool, see www.siemens.com/conversion-tool



Video: Temperature monitoring with SIRIUS relays at a glance

The 3RS2 temperature monitoring relays can be used to measure temperatures in solid, liquid and gas media. The temperature is measured by means of sensors in the medium, analyzed by the device and monitored for overshooting, undershooting or being within a specified range (window function).

The family comprises an analog multi-function device which can be set using DIP switches and potentiometers, and digital devices which can be parameterized via an intuitive LC display. The digital device is also available as a version with IO-Link.

All 3RS26 digital devices, including the 3RS28 versions with IO-Link, come with Safety certification according to IEC 61508/IEC 62061 or ISO 13849 up to SIL 1/PL c as well as EN 14597 for heat generating systems and EN 50156 for burners.

Furthermore, the functionality of the 3RS26/3RS28 digital devices can be expanded using a 3RS29 sensor expansion module with two additional resistance sensors, e.g. for monitoring 3-phase motors or transformers.

The 3RS29 sensor expansion module also features an additional relay for outputting the sensor status, and an additional analog input 4 to 20 mA. This analog input allows ATEX applications to be implemented when using an intrinsically safe temperature sensor or other appropriate type of protection. The 3RS29 is connected wirelessly via a SIL 1-certified infrared communications interface.

Analog multi-function devices



SIRIUS 3RS25 analog multi-function device

The analog multi-function device is parameterized using DIP switches and potentiometers. The device can be used to monitor a sensor with a limit value for overshoot or undershoot. The most common temperature ranges with Pt100 resistance sensors or type J or K thermocouples can be used for this purpose. This device can therefore also be used as a compact, easy-to-adjust two-point controller. The relay CO contact output enables loads to be switched directly. The NC contact can optionally be used as a signaling contact.

Digital devices (1 sensor)



SIRIUS 3RS26 digital device (1 sensor) with 3RS29 sensor expansion module

The SIRIUS 3RS26 digital device with display enables sensors with two limit values to be monitored using all common resistance sensors and thermocouples.

The additional limit value means that, in addition to overshoot and undershoot, an additional warning value can be output to the relay outputs. Alternatively, the second monitoring value can also be used to implement range monitoring. The digital devices can thus also be used as compact two-step or three-step controllers, with manual RESET or remote RESET.

Thanks to Safety certifications, this device can be used in a wide range of applications.

The functionality of the SIRIUS 3RS26 and 3RS28 digital devices can be expanded wirelessly with the sensor expansion module via a SIL 1-certified infrared communications interface. This combination then features three sensors and is designed for monitoring large 3-phase motors and transformers. It goes without saying that the additional sensors can also be used for other applications.

Digital devices (1 sensor) for IO-Link



SIRIUS 3RS28 digital device (1 sensor) for IO-Link with 3RS29 sensor expansion module

The 3RS28 digital temperature monitoring relays for IO-Link feature an IO-Link communications interface in addition to a display. They include all functions of the 3RS26 digital device and can also be operated on L+/L- as a stand-alone installation with 24 V DC.

Note:

The IO-Link devices can be reset on the display or via IO-Link.

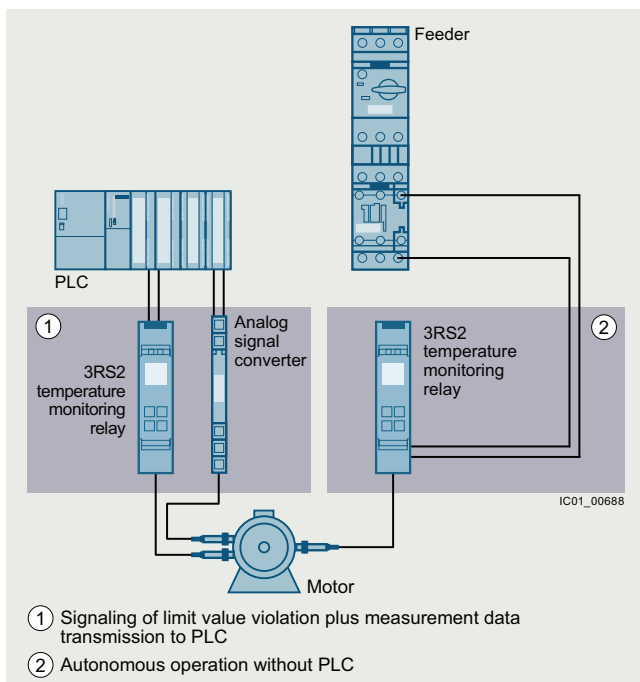

Conventional temperature monitoring relays

Notes:

Devices required for communication via IO-Link:

- Any controller that supports IO-Link (e.g. ET 200SP with CPU or S7-1200), see [Catalog ST 70](#).
- IO-Link master (e.g. CM 4xIO-Link for SIMATIC ET 200SP, see [page 2/94](#) or SM 1278 for S7-1200, see [page 2/93](#)).

Each monitoring relay requires an IO-Link channel.

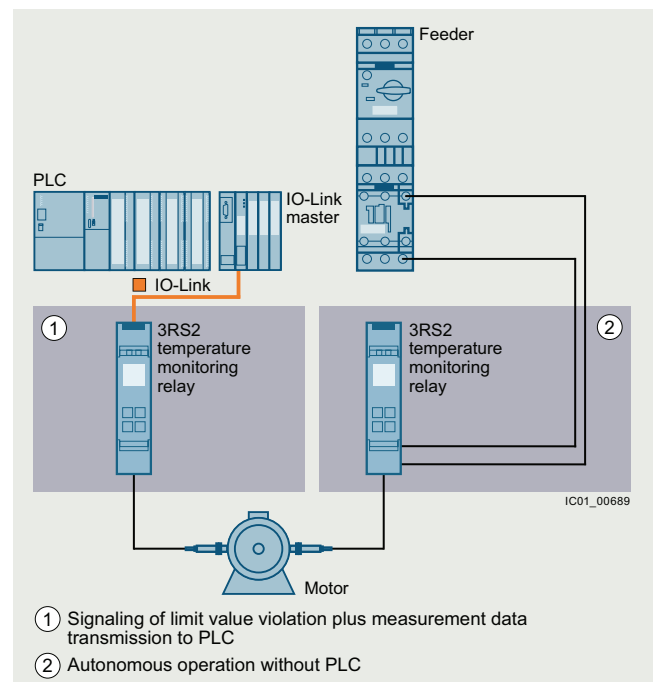

Temperature monitoring relays for IO-Link

Notes on security

In order to protect plants, systems, machines and networks against cyber threats, it is necessary to implement – and continuously maintain – a holistic, state-of-the-art industrial cybersecurity concept. Siemens products and solutions represent one component of such a concept.

For more information on industrial cybersecurity, see www.siemens.com/cybersecurity-industry.

Monitoring and control devices

Relays

SIRIUS 3RS2 temperature monitoring relays

General data

Article number scheme

Product versions		Article number	
Temperature monitoring relays		3RS2	<input type="checkbox"/> 0 0 - <input type="checkbox"/> <input type="checkbox"/> <input type="checkbox"/> <input type="checkbox"/> 0
Device type	e.g. 5 = analogically adjustable	<input type="checkbox"/>	
Connection type	Screw terminals		1
	Spring-loaded terminals (push-in)		2
Number of CO contacts	e.g. A = 1 CO contact, B = 2 CO contacts	<input type="checkbox"/>	
Rated control supply voltage	A = 24 V AC/DC, W = 24 ... 240 V AC/DC		<input type="checkbox"/>
Type of rated control supply voltage	3 = AC/DC, 4 = DC		<input type="checkbox"/>
Example		3RS2	5 0 0 - 1 A A 3 0

Note:

The article number scheme shows an overview of product versions for better understanding of the logic behind the article numbers.

For your orders, please use the article numbers quoted in the selection and ordering data.

Benefits

- Customary screw and spring-loaded terminals for quick and reliable wiring
- Reduced space requirement in the control cabinet thanks to a consistent width of 22.5 mm
- Easy parameterization thanks to new display and intuitive operating concept
- Reduced stock-keeping and logistics thanks to heavily reduced device variance
- Cost savings thanks to additional scalable functionality with integrated infrared interface
- Communication via IO-Link for 3RS28
- Global applicability and exportability thanks to compliance with international standards and certifications
- Problem-free use in a wide range of applications thanks to Safety bundle with certification according to SIL 1/PL c, ATEX, EN 14597 for heat generating systems and EN 50156 for burners
- All versions with removable terminals
- All versions with screw or spring-loaded terminals with push-in functionality

Application

The SIRIUS 3RS2 temperature monitoring relays can be used in almost any application in which temperature overshoot or undershoot is not permitted, e.g. in the monitoring of set temperature limits and the output of alarm messages for:

- Simple and compact two-point control
- Motor and system protection
- Control cabinet temperature monitoring
- Freeze monitoring
- Temperature limits for process variables e.g. in the packaging industry or electroplating
- Controlling equipment and machines such as heating, climate and ventilation systems, solar collectors, heat pumps or warm water supplies
- Motor, bearing and gear oil monitoring
- Monitoring of coolants

Additionally for digital devices

- Simple and compact two-point or three-point control
 - Burner according to EN 50156
 - Temperature monitors or temperature limiters¹⁾ according to EN 14597
 - ATEX explosion protection according to EN 50495
- ¹⁾ A 3RS29 sensor expansion module with an additional sensor is required for the function as a temperature limiter.

Technical specifications

More information

Technical specifications, see <https://support.industry.siemens.com/cs/ww/en/ps/25719/td>
Equipment Manual and internal circuit diagrams, see <https://support.industry.siemens.com/cs/ww/en/ps/25719/man>

FAQs, see <https://support.industry.siemens.com/cs/ww/en/ps/25719/faq>

Connection of resistance-type thermometers

Two-wire measurement

When two-wire temperature sensors are used, the resistances of the sensor and wiring are added. The resulting systematic error must be taken into account when the evaluation unit is calibrated. A jumper must be clamped between terminals T2 and T3 for this purpose.

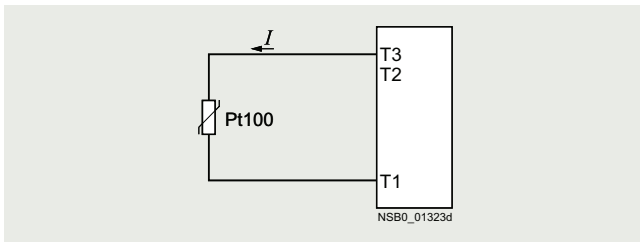

Wiring errors

The errors that are generated by the wiring comprise approximately 2.5 K/Ω. If the resistance of the cable is not known and cannot be measured, the wiring errors can also be estimated using the following table.

Temperature drift dependent on the length and cross-section of the cable with Pt100 sensors and an ambient temperature of 20 °C, in K:

Cable length in m	Cross-section mm ²			
	0.5	0.75	1	1.5
	Temperature drift in K:			
0	0	0	0	0
10	1.8	1.2	0.9	0.6
25	4.5	3.0	2.3	1.5
50	9.0	6.0	4.5	3.0
75	13.6	9.0	6.8	4.5
100	18.1	12.1	9.0	6.0
200	36.3	24.2	18.1	12.1
500	91.6	60.8	45.5	30.2

Example: On a Pt100 sensor with a cable length of 10 m and a conductor cross-section of 1 mm² the temperature drift equals 0.9 K.

Three-wire measurement

To minimize the effects of the line resistances, a three-wire circuit is often used. Using the additional cable, two measuring circuits can be formed of which one is used as a reference. The evaluation unit can then automatically calculate the line resistance and take it into account.

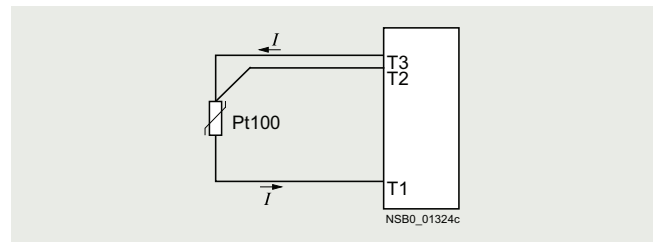

Connection of thermocouples

Based on the thermo-electrical effect, a differential temperature measurement will be performed between the measuring point and the evaluation unit.

This principle assumes that the evaluation unit knows the temperature at the clamping point (T2). For this reason, the 3RS2 temperature monitoring relays have an integral reference point compensation that determines this comparison temperature and builds it into the result of the measurement. The thermal sensors and cables must therefore be insulated.

The absolute temperature is therefore calculated from the ambient temperature of the evaluation unit and the temperature difference measured by the thermocouple.

Temperature detection is therefore possible (T1) without needing to know the precise ambient temperature of the clamping point at the evaluation unit (T2).

The connecting cable is only permitted to be extended using compensating lines that are made from the same material as the thermocouple. If a different type of conductor is used, an error will result in the measurement.

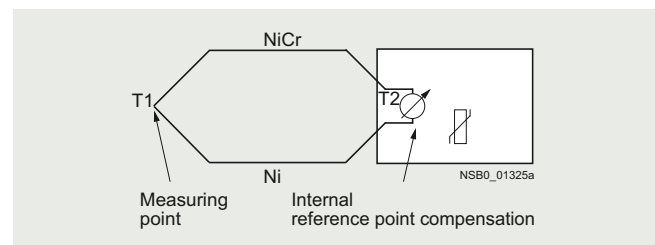

For more information, see www.ephyMess.de/en.

Monitoring and control devices

Relays

SIRIUS 3RS2 temperature monitoring relays

General data

Principle of operation

Once the temperature has reached the set threshold value ϑ_1 , the K1 output relay changes its switching state as soon as the set time t has elapsed (K2 responds in the same manner to ϑ_2). The delay time can only be adjusted with digital units (on analog units $t = 0$).

When automatic RESET (AUTO RST) is set, the relays return to their original state as soon as the temperature reaches the set hysteresis value.

The memory function (MEMORY) allows the status to be saved even in the event of a voltage failure.

3RS25 analog multi-function devices

Temperature overshoot

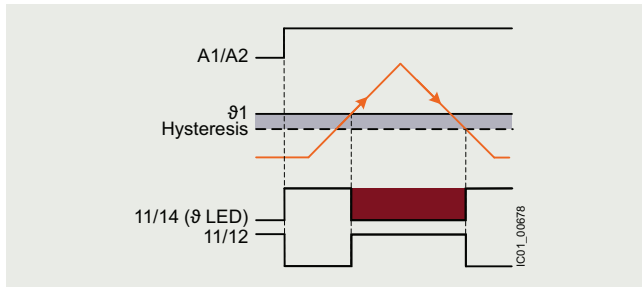

Temperature undershoot

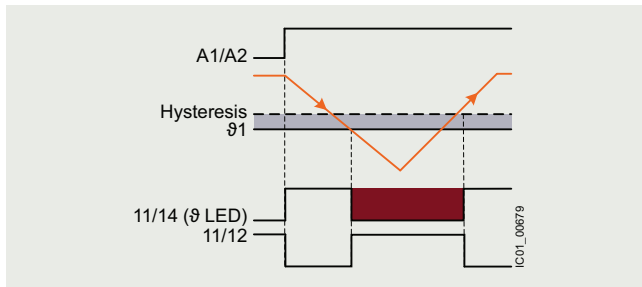

3RS26, 3RS28 digital devices (1 sensor) with Safety function

Temperature monitors according to EN 14597

Temperature overshoot

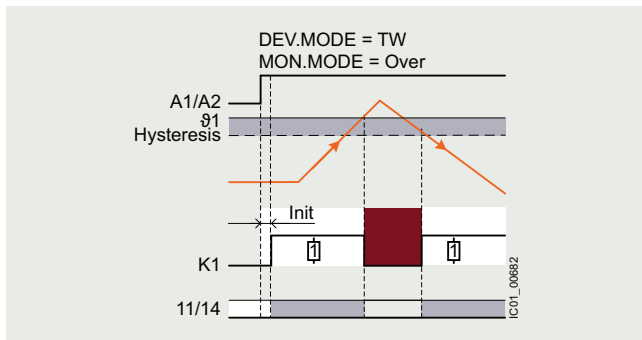

Temperature undershoot

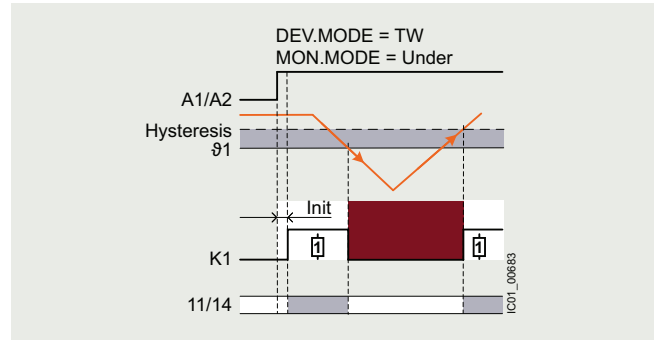

Temperature limiters according to EN 14597/ATEX

Temperature overshoot

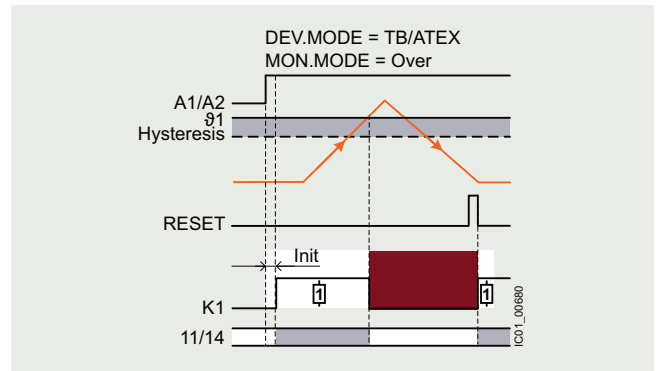

Temperature undershoot

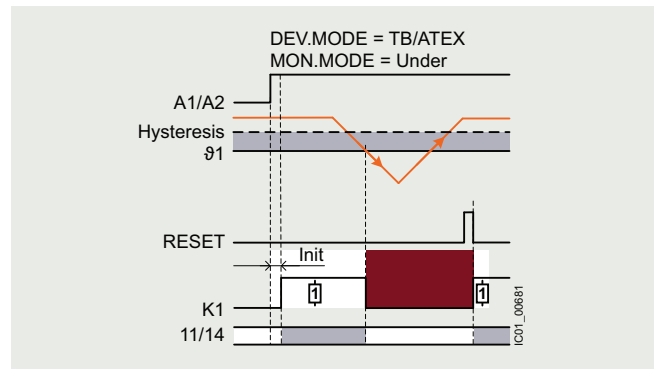

3RS26, 3RS28 digital devices (1 sensor)

Temperature overshoot

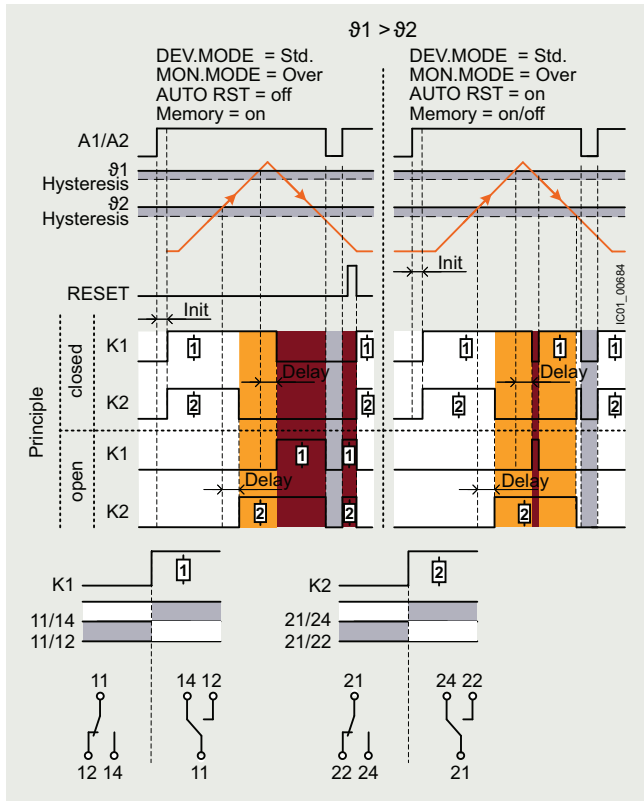

Range monitoring

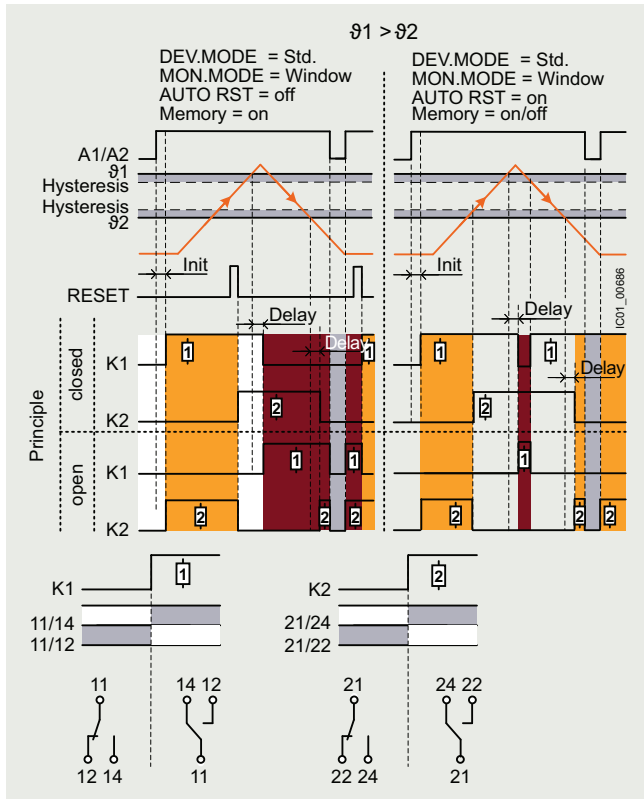

Temperature undershoot

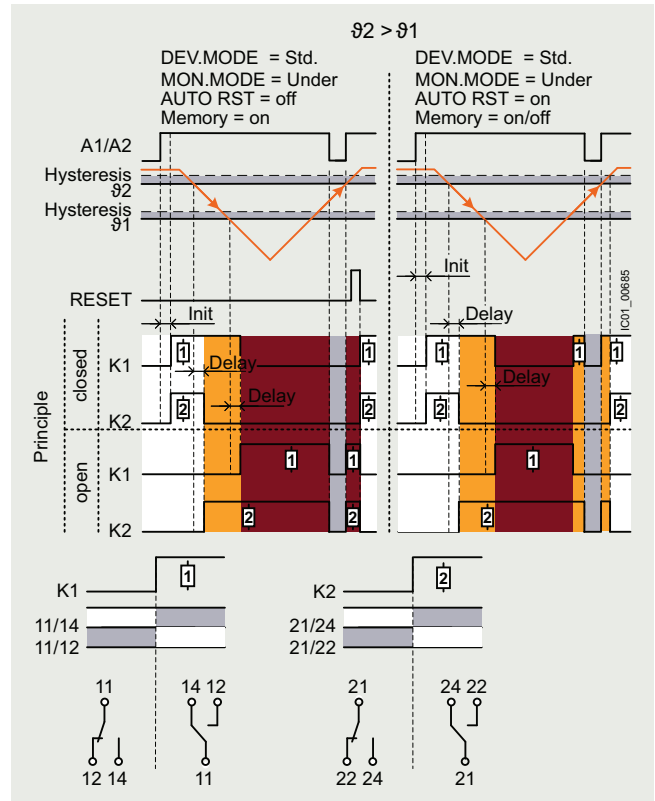

Range monitoring

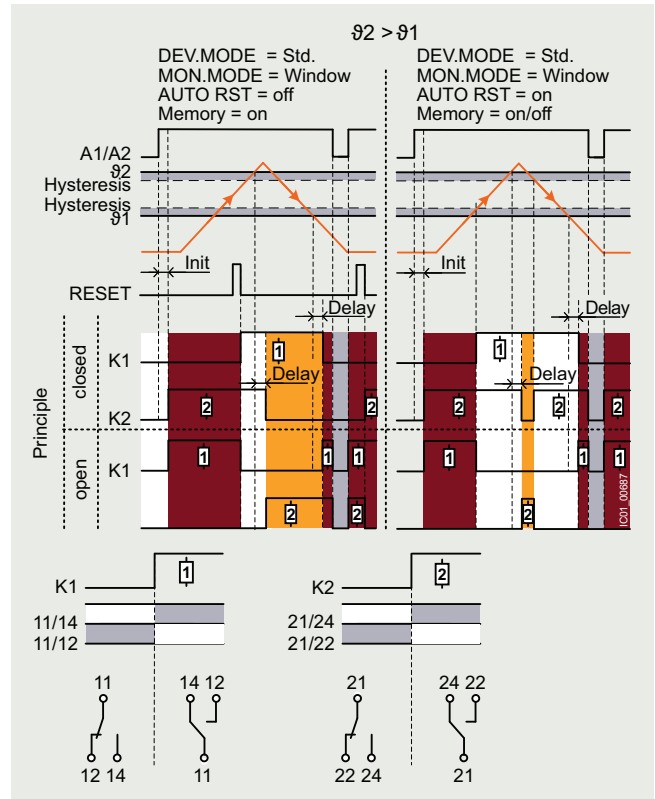

Monitoring and control devices

Relays

SIRIUS 3RS2 temperature monitoring relays

General data

Characteristic curves

For resistance sensors

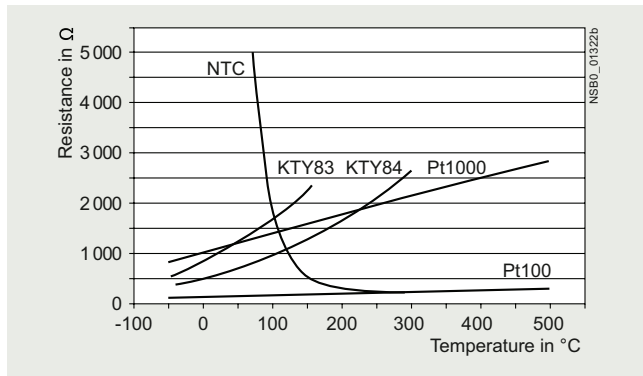

Characteristic curves for resistance sensors

The short-circuit and open-circuit detection as well as the measuring range is limited, depending on the sensor type.

Measuring ranges and switch position for analog devices in °C for Pt100 resistance sensor

Measuring range in °C	Switch position in °C										
	min.					1/2					max.
0 ... +100	0	10	20	30	40	50	60	70	80	90	100
0 ... +200	0	20	40	60	80	100	120	140	160	180	200
-50 ... +50	-50	-40	-30	-20	-10	0	10	20	30	40	50

Measuring ranges for digital devices in °C for resistance sensor

Sensor type	Short circuit	Open circuit	3RS26, 3RS28 Measuring range in °C	3RS26, 3RS28 Measuring range in °F
Pt100	✓	✓	-50 ... +750	-58 ... +1 382
Pt1000	✓	✓	-50 ... +500	-58 ... +932
KTY83-110	✓	✓	-50 ... +175	-58 ... +347
KTY84	✓	✓	-40 ... +300	-40 ... +572
NTC ¹⁾	✓	--	+80 ... +160	+176 ... +320

✓ Detection possible

-- Detection not possible

¹⁾ NTC type: B57227-K333-A1 (100 °C: 1.8 kΩ; 25 °C: 32.762 kΩ).

For thermocouples

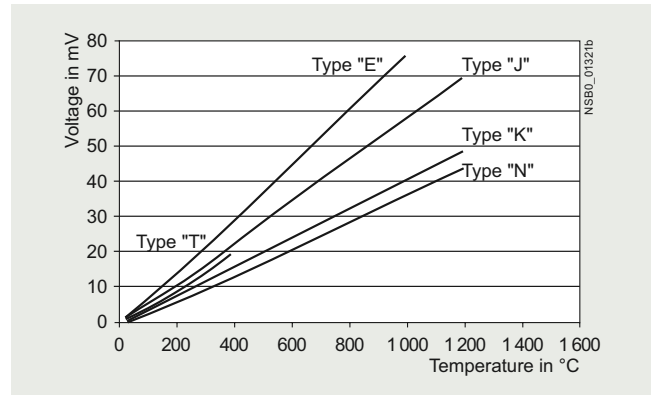

Characteristic curves for thermocouples J, K, T, E, and N

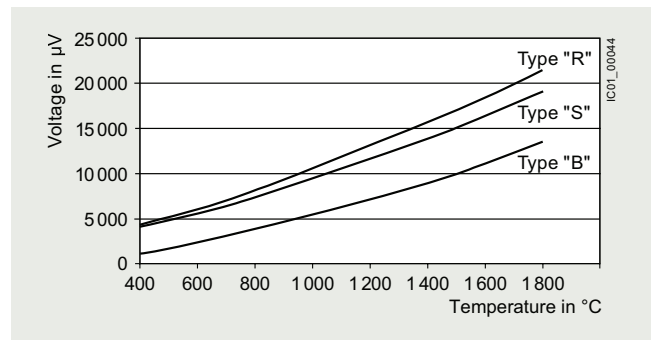

Characteristic curves for thermocouples S, R and B

Measuring ranges and switch position for analog devices in °C for thermocouple types J and K

Measuring range in °C	Switch position in °C										
	min.					1/2					max.
0 ... +200	0	20	40	60	80	100	120	140	160	180	200
0 ... +600	0	60	120	180	240	300	360	420	480	540	600
+500 ... +1 000	500	550	600	650	700	750	800	850	900	950	1 000



Measuring ranges for digital devices in °C/°F for thermocouples

Sensor type	Short circuit	Open circuit	3RS26, 3RS28 Measuring range in °C	3RS26, 3RS28 Measuring range in °F
J	--	✓	-99 ... +1 200	-146.2 ... +2 192
K	--	✓	-99 ... +1 350	-146.2 ... +2 462
T	--	✓	-99 ... +400	-146.2 ... +752
E	--	✓	-99 ... +999	-146.2 ... +1 830.2
N	--	✓	-99 ... +1 300	-146.2 ... +2 372
S	--	✓	0 ... +1 750	+32 ... +3 182
R	--	✓	0 ... +1 750	+32 ... +3 182
B	--	✓	+400 ... +1 800	+752 ... +3 272

✓ Detection possible

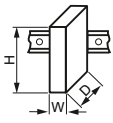
-- Detection not possible

Article number	3RS2500-...0	3RS2600-...0	3RS2800-...0	3RS2900-...0
General technical specifications				
Width x height x depth	mm 22.5 x 100 x 90			
				
Permissible ambient temperature				
• During operation	°C	-25 ... +60		
• During transport	°C	-40 ... +85		
• During storage	°C	-40 ... +85		
Degree of protection IP	IP20			
Mounting position	Any			
Type of mounting	Screw and snap-on mounting on 35 mm DIN-rail			
Auxiliary circuit				
Type of voltage	AC/DC		DC	AC/DC
Operating range factor of the control supply voltage, rated value				
• At AC at 50 Hz	0.85 ... 1.1		--	0.85 ... 1.1
• At AC at 60 Hz	0.85 ... 1.1		--	0.85 ... 1.1
• At DC	0.85 ... 1.1		0.7 ... 1.25	0.85 ... 1.1
Operating frequency, rated value	Hz	50 ... 60		
Number of measuring circuits	1			3
Number of CO contacts for auxiliary contacts	1		2	0
Product function				
• Removable terminal for auxiliary and control circuit	Yes		--	
• Automatic RESET	Yes		--	
• Fault storage	No		Yes	
• External RESET	No		Yes	
ATEX				
Certificate of suitability				
• Relative to ATEX	No	Yes, with 3RS29 sensor expansion module		Yes, with 3RS26/3RS28 digital device
Safety Integrity Level (SIL) according to IEC 62061	--		SIL 1	
Performance Level (PL) according to ISO 13849-1	--		PL c	

Article number	3RS2500-1...0, 3RS2600-1...0, 3RS2800-1...0, 3RS2900-1...0	3RS2500-2...0, 3RS2600-2...0, 3RS2800-2...0, 3RS2900-2...0
Type of electrical connection	 Screw terminals	 Spring-loaded terminals (push-in)
Tightening torque	0.6 ... 0.8 Nm	
Type of connectable conductor cross-sections		
• Solid	1 x (0.5 ... 4 mm ²), 2 x (0.5 ... 2.5 mm ²)	
• Finely stranded	--	
- Without end sleeve	1 x (0.5 ... 4 mm ²), 1 x (0.5 ... 2.5 mm ²)	
- With end sleeve	1 x (0.5 ... 4 mm ²), 2 x (0.5 ... 2.5 mm ²)	
• For AWG cables	--	
- Solid	1 x (20 ... 12), 2 x (20 ... 14)	
- Stranded	1 x (20 ... 12) 1 x (20 ... 12)	

Monitoring and control devices

Relays

SIRIUS 3RS2 temperature monitoring relays

Basic units

Selection and ordering data

PU (UNIT, SET, M) = 1
 PS* = 1 unit
 PG = 41H

Multi-unit packaging, see page 16/7.

Number of sensor, connectable	Type of sensor, connectable	Control supply voltage		Suitability for use	Screw terminals 		Spring-loaded terminals (push-in) 	
		at AC at 50/60 Hz	at DC		Article No.	Price per PU	Article No.	Price per PU
		V	V					

Temperature monitoring relays

Analog multi-function devices, 1 sensor, 1 threshold value



3RS2500-1AA30

1	Resistance sensors: Pt100	24	24	--
	Thermocouples: Type J, K	24 ... 240	24 ... 240	--

3RS2500-1AA30
3RS2500-1AW30

3RS2500-2AA30
3RS2500-2AW30



3RS2600-1BA30

Digital devices, 1 sensor, 2 threshold values

1	Resistance sensors: Pt100, Pt1000, KTY83-110, KTY84, NTC	24	24	--
	Thermocouples: Type J, K, T, E, N, S, R, B	24 ... 240	24 ... 240	--

3RS2600-1BA30
3RS2600-1BW30

3RS2600-2BA30
3RS2600-2BW30



3RS2800-1BA40

Digital device for IO-Link, 1 sensor, 2 threshold values

1	Resistance sensors: Pt100, Pt1000, KTY83-110, KTY84, NTC	--	24	--
	Thermocouples: Type J, K, T, E, N, S, R, B			

3RS2800-1BA40

3RS2800-2BA40

Sensor expansion modules



3RS2900-1AA30

2 additional resistance sensors, analog input 4 ... 20 mA, ATEX via analog input, status relay









3	Resistance sensors: Pt100, Pt1000, KTY83-110, KTY84, NTC	24	24	For 3RS26/3RS28 digital devices
		24 ... 240	24 ... 240	

3RS2900-1AA30
3RS2900-1AW30

3RS2900-2AA30
3RS2900-2AW30

Accessories, see page 10/125.

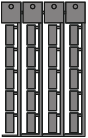
Selection and ordering data

Version	Article No.	Price per PU	PU (UNIT, SET, M)	PS*	PG
Terminals for SIRIUS devices in the industrial DIN-rail enclosure					
 3ZY1122-1BA00	Removable terminals, without inscription <ul style="list-style-type: none"> • 2-pole, up to 1 x 4 mm² or 2 x 2.5 mm² • 2-pole, up to 1 x 4 mm² or 2 x 1.5 mm² (in shared end sleeve) 	Screw terminals  3ZY1122-1BA00	1	6 units	41L
		Spring-loaded terminals (push-in)  3ZY1122-2BA00	1	6 units	41L
Accessories for enclosures					
 3ZY1321-2AA00	Sealing covers 22.5 mm wide	3ZY1321-2AA00	1	5 units	41L
 3ZY1311-0AA00	Push-in lugs for wall mounting (Two lugs are required per device)	3ZY1311-0AA00	1	10 units	41L
 3ZY1440-1AA00	Coding pins For removable terminals of SIRIUS devices in the industrial DIN-rail enclosure; enable the mechanical coding of terminals	3ZY1440-1AA00	1	12 units	41L
 3ZY1450-1AB00	Hinged covers Replacement covers, without terminal labeling, titanium gray 22.5 mm wide	3ZY1450-1AB00	1	5 units	41L
Blank labels					
 3RT2900-1SB20	Unit labeling plates¹⁾ For SIRIUS devices 20 mm x 7 mm, titanium gray	3RT2900-1SB20	100	340 units	41B
Tools for opening spring-loaded terminals					
 3RA2908-1A	Screwdriver For all SIRIUS devices with spring-loaded terminals Length approx. 200 mm, 3.0 mm x 0.5 mm, titanium gray/black, partially insulated	Spring-loaded terminals (push-in)  3RA2908-1A	1	1 unit	41B

¹⁾ PC labeling system for individual inscription of unit labeling plates available from: murrplastik Systemtechnik GmbH, see page 16/18.

For suitable sensors, see www.siemens.com/temperature.

Monitoring and control devices

Relays

SIRIUS 3RN2 thermistor motor protection

General data

Overview



SIRIUS 3RN2 thermistor motor protection

More information

Homepage, see www.siemens.com/sirius-monitoring-relays
 SiePortal, see www.siemens.com/product_catalog_siep?3RN2
 TIA Selection Tool Cloud (TST Cloud), see
www.siemens.com/tstcloud/?node=SIRIUSRelais
 Conversion tool, see www.siemens.com/conversion-tool



Video: SIRIUS 3RN2 thermistor motor protection relays

Thermistor motor protection devices are used for direct monitoring of the motor winding temperature. For this purpose, the motors are equipped with temperature-dependent resistors (PTC) that are directly installed in the motor winding by the motor manufacturer and abruptly change their resistance at their temperature limit.

Versions

SIRIUS 3RN2 thermistor motor protection relays are available in the following versions:

- 3RN2000 compact evaluation unit
- 3RN2010 compact/standard evaluation unit
- 3RN2012-.BW31 bistable evaluation unit
- 3RN2011, 3RN2012-...30, 3RN2013 standard evaluation unit with ATEX approval
- 3RN2023 evaluation unit with ATEX approval and 2 sensor circuits for warning and disconnection

They comply with

- IEC 60947-8 Low-voltage switchgear and controlgear – Part 8: "Control units for built-in thermal protection (PTC) for rotating electrical machines"
- IEC 61000-6-2, IEC 61000-6-4. "Electromagnetic compatibility for industrial-process measurement and control equipment"

The 3RN2 thermistor motor protection relays with ATEX approval according to EN 50495 meet SIL 1 according to IEC 62061.

The terminals of the auxiliary contacts are designated in accordance with EN 60947-1.

3RN2 evaluation units are suitable for snap-on mounting on TH 35 DIN rails according to IEC 60715 or for screw fixing using an adapter (accessory).

Article number scheme

Product versions		Article number								
Thermistor motor protection relay with PTC sensor, type A		3RN20	□	□	-	□	□	□	□	□
Number and version of the sensor circuits	1 sensor circuit, supply voltage = root voltage	0								
	1 sensor circuit	1								
	2 sensor circuits for warning and disconnection	2								
RESET	Automatic RESET	0								
	Manual RESET, with open-circuit and short-circuit detection	1								
	Manual/automatic/remote RESET, non-volatile, with open-circuit and short-circuit detection	2								
	Manual/automatic/remote RESET, non-volatile, with open-circuit and short-circuit detection, with protective separation	3								
Connection method	Screw terminals					1				
	Spring-loaded terminals (push-in)					2				
Auxiliary switches	1 CO								A	
	2 CO								B	
	1 NO + 1 NC								C	
	1 NO + 1 CO								D	
	2 CO, hard gold-plated								G	
Rated control supply voltage	24 V AC/DC								A 3	
	24 ... 240 V AC/DC								W 3	
Response to failure	Monostable									0
	Bistable									1
Example		3RN20	0	0	-	1	A	A	3	0

Note:

The article number scheme shows an overview of product versions for better understanding of the logic behind the article numbers.

For your orders, please use the article numbers quoted in the selection and ordering data.

Benefits

- Thanks to direct motor protection, overdimensioning of the motors is not necessary
- No settings on the device are necessary
- Solid-state compatible output thanks to versions with hard gold-plated contacts
- Rapid error diagnostics thanks to versions that indicate open and short circuits in the sensor circuit
- All versions with removable terminals
- All versions with screw or spring-loaded terminals with push-in functionality

Application

Direct motor protection through temperature monitoring of the motor winding offers 100% motor protection even under the most difficult ambient conditions, without the need to make adjustments on the device. Versions with hard gold-plated contacts additionally ensure a switching reliability that is higher than that of an electronic control.

Direct motor protection

- At increased ambient temperatures
- When switching frequency is too high
- When startup and braking procedures are too long

ATEX approval for operation in hazardous areas

The SIRIUS 3RN2011, 3RN2012-...30, 3RN2013 and 3RN2023 thermistor motor protection relays for PTC sensors are certified according to ATEX Ex II (2) G and D for environments with explosive gas or dust loads.

Motor protection using current- and temperature-dependent protective devices

IEC 60204 stipulates that motors must be protected from overheating at a rating of 0.5 kW and higher. The protection can take the form of overload protection, overtemperature protection or current limiting.

For motors with frequent starting and braking and in environments where cooling may be impaired (e.g. by dust), it is recommended to use the overtemperature protection option in the form of a protective device coordinated with this mode of operation. A good choice in this case is the use of 3RN2 thermistor motor protection devices.

On rotor-critical motors, overtemperature detection in the stator windings can lead to delayed and hence inadequate protection. In this case the standards stipulate additional protection, e.g. by means of an overload relay.

This combination of thermistor motor protection and overload relay is recommended for full motor protection in case of frequent starting and braking of motors, irregular intermittent duty or excessive switching frequency. To prevent premature tripping of the overload relay in such operating conditions, a higher setting than that normally required for the operational current is chosen. The overload relay then performs stall protection, and the 3RN2 thermistor motor protection relay monitors the temperature of the motor windings.

Application	Motor protection		
	Current-dependent only, e.g. with overload relay	Temperature-dependent only, e.g. with thermistor motor protection relay	Current- and temperature-dependent
Motor protection in case of			
Overloading in uninterrupted duty	✓	✓	✓
Long startup and braking operations	○	✓	✓
Irregular intermittent duty	○	✓	✓
When switching frequency is too high	○	✓	✓
1-phase operation and current asymmetry	✓	✓	✓
Voltage and frequency fluctuations	✓	✓	✓
Stalling of the rotor	✓	✓	✓
Switching on a stalled rotor of a stator-critical motor	✓	✓	✓
Switching on a stalled rotor of a rotor-critical motor	✓	○	✓
Elevated ambient temperature	--	✓	✓
Impeded cooling	--	✓	✓

- ✓ Full protection
- Conditional protection
- No protection

Monitoring and control devices

Relays

SIRIUS 3RN2 thermistor motor protection

General data

Technical specifications

More information

Technical specifications, see <https://support.industry.siemens.com/cs/ww/en/ps/24302/td>
Operating Instructions and internal circuit diagrams, see <https://support.industry.siemens.com/cs/ww/en/ps/24302/man>

FAQs, see <https://support.industry.siemens.com/cs/ww/en/ps/24302/faq>
For more information on explosion protection (ATEX), see www.siemens.com/sirius/atex

Type A PTC temperature sensor

If a Type A temperature sensor is connected to a Type A evaluation unit, compliance with the operating temperatures is assured (on pick-up and reset) according to IEC 60947-8.

The characteristic curves of the Type A temperature sensors are described in IEC 60947-8, DIN 44081 and DIN 44082 standards.

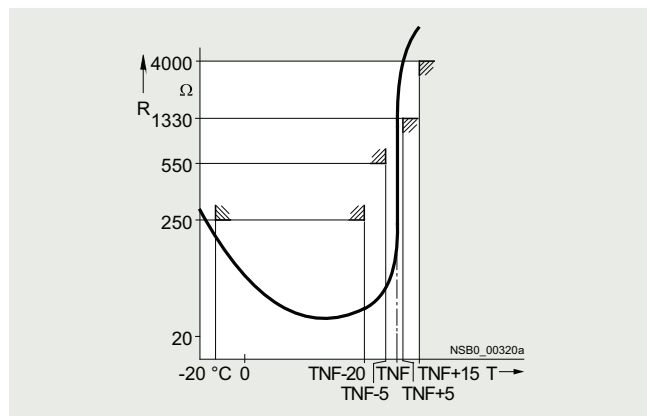

Characteristic curve of the 3RN2 evaluation unit

Bimetallic switch

In some applications, bimetallic switches (e.g. Klixon, Thermoclick) are used as sensors instead of PTC temperature sensors. Bimetallic switches are temperature- and current-dependent NC contacts and are available for different temperature ranges. Because bimetallic switches have practically no resistance below their opening temperature, short-circuit detection is not possible when using bimetallic switches. A bimetallic switch can be used for versions 3RN2000 and 3RN2010 on the SIRIUS thermistor motor protection relay.

Note:

Never use bimetallic switches in applications subject to an explosion hazard! Because of their non-standardized tripping characteristic, bimetallic switches must not be used in hazardous applications. Use Type A PTC sensors instead!

Use in hazardous areas

Increased danger in hazardous areas means it is necessary to observe the following notes and standards carefully:

- EN 60079-14/VDE 0165-1 for electrical apparatus for hazardous areas
- EN 60079-17 Explosive atmospheres - Electrical installations inspection and maintenance
- EN 50495 Safety devices required for the safe functioning of equipment with respect to explosion risks

The following SIRIUS 3RN2 thermistor motor protection relays with short-circuit detection are approved for Equipment Group II, Category (2) in Area "G" (areas in which potentially explosive gas, vapor, mist, or air mixtures are present) and are additionally approved for Area "D" (areas containing combustible dust):

- 3RN2011
- 3RN2012-...30
- 3RN2013
- 3RN2023

PTB 15 ATEX 3011 ex II (2) G (Ex e) (Ex d) (Ex px)

PTB 15 ATEX 3011 ex II (2) D (Ex t) (Ex p)

For 3RN2 thermistor motor protection relays, the EC type-examination certificate is available for Group II, Category (2) G [Ex e] [Ex d] [Ex px] and D [Ex t] [Ex p]. The number is PTB 15 ATEX 3011.

SIRIUS 3RN2 thermistor motor protection relays are not intended for installation in hazardous areas. If they are installed in a hazardous area, the SIRIUS 3RN2 thermistor motor protection relays must be adapted to the applicable type of protection.

The machine or plant must shut down immediately if the SIRIUS 3RN2 thermistor motor protection relay is tripped, even if connected through a frequency converter. This must be implemented with circuitry.

SIRIUS 3RN2 thermistor motor protection relays with functional safety according to EN 50495 are suitable for protecting explosion-proof motors/machines.

On evaluation units with a supply voltage of 24 V AC/DC, you must ensure electrical separation with a battery network or a power supply unit with electrical separation (e.g. isolating transformer) (does not apply to 3RN2013-.BA30).

A SIRIUS 3RN2 thermistor motor protection relay set to "Automatic RESET" mode will be reset automatically after the recovery time has elapsed, without the RESET button being pressed. An additional ON button has to be used to ensure that the motor does not start up automatically following tripping. "Automatic RESET" mode must not be used in applications where there is a risk of personal injury or damage to property if the motor restarts unexpectedly.

⚠ NOTICE!

When used in a hazardous area, the thermistor motor protection relay must not be operated with automatic RESET (terminals Y1 and Y2 permanently jumpered).

A risk analysis must be performed for the complete plant or machine. If this analysis yields a lower hazard potential (category 1), all SIRIUS 3RN2 thermistor motor protection relays can be used, provided the safety regulations are observed.

⚠ WARNING!

All work involved in connecting, commissioning and maintenance must be carried out by qualified, responsible personnel. Improper handling may result in serious personal injury and considerable damage to property.

Cable routing

The measuring circuit leads must be routed as separate control cables. It is not permitted to use cores from the supply line of the motor or any other main supply cables. If extreme inductive or capacitive interference is expected as a result of power lines routed in parallel, shielded control cables must be used.

Maximum length of sensor circuit cables for evaluation units without short-circuit detection in the sensor circuit:

Cable cross-section	3RN2000, 3RN2010
2.5 mm ²	2 x 2 800 m
1.5 mm ²	2 x 1 500 m
0.5 mm ²	2 x 500 m

Maximum length of sensor circuit cables for evaluation units with short-circuit detection¹⁾:

Cable cross-section	3RN2011, 3RN2012, 3RN2013, 3RN2023
2.5 mm ²	2 x 250 m
1.5 mm ²	2 x 150 m
0.5 mm ²	2 x 50 m

¹⁾ A short circuit in the sensor circuit will be detected up to these maximum cable lengths.

Principle of operation

SIRIUS 3RN2 thermistor motor protection relays are thermal protection devices that are suitable, in combination with Type A PTC thermistors, for monitoring temperatures of electrical drives, transformer windings, oils, bearings, air, etc.

The most frequent application is monitoring of three-phase motors in which the motor manufacturer has fitted a PTC sensor into every winding overhang and in which these PTC sensors are connected in series.

The SIRIUS 3RN2 thermistor motor protection relays operate in accordance with the closed-circuit principle and therefore monitor themselves for loss of supply voltage. The exceptions are the warning output on 3RN2023, which always works on the open-circuit principle and the bistable relays of the 3RN2012-BW31, which always retain the last switching state.

A micro-interruption in the power supply of less than 30 ms does not change the status of the output relays.

For devices with the "Manual RESET" function, the test function can be activated and a trip simulated by pressing the blue Test/RESET button for > 2 seconds.

The 3RN2011, 3RN2012, 3RN2013 and 3RN2023 devices are additionally equipped with open-circuit and short-circuit detection in the sensor circuit. The unit will trip in the event of a short circuit (resistance in sensor circuit < 10 Ω) or open circuit in the sensor circuit (dynamic open-circuit detection). Tripping as the result of a short circuit in the sensor circuit is indicated by a flickering red LED (TRIPPED) (in the event of a short circuit in the sensor circuit for warning on the 3RN2023, the yellow warning LED (WARNING) flickers.) The devices with dynamic open-circuit detection evaluate the rise time of the sensor circuit resistance. If the sensor circuit resistance rises from 3 300 Ω to 12 kΩ within 200 ms, the unit will not only trip, but also indicate the open circuit via a flashing red LED (TRIPPED) (in the event of an open circuit in a sensor circuit, the yellow warning LED (WARNING) flashes for the 3RN2023.)

All evaluation units (except for the 3RN2000 compact evaluation unit) feature electrical separation between the control circuit and the sensor circuit. The relay outputs are also electrically separated from all other circuits. The 3RN2013 and 3RN2023 evaluation units incorporate protective electrical separation between all circuits up to $U_i = 300$ V.

3RN2000 compact evaluation unit

The compact unit, which is only 17.5 mm wide, is equipped with a red LED (TRIPPED) for the tripped indicator and a changeover contact. After the unit has tripped, it is automatically reset once the thermistors have cooled down. The root of the changeover contact is connected to the control voltage (terminal 11 is connected to terminal A1). This unit is particularly suitable in circuits in which the control circuit and signaling circuit have the same potential, e.g. in local control boxes.

3RN2010, 3RN2011, 3RN2012, 3RN2013 compact/standard evaluation units

The units are equipped with two LEDs (READY and TRIPPED) for an operating and tripped display and are available with either 1 NO + 1 NC contacts (3RN2010, overall width 17.5 mm) or with 2 CO contacts. Depending on the version, they are available with automatic RESET (3RN2010), manual/remote RESET (3RN2011) or manual/automatic and remote RESET (3RN2012 and 3RN2013). Remote RESET can be achieved by connecting an external pushbutton with a normally-open function to terminals Y1 and Y2. If terminals Y1 and Y2 are jumpered, the unit is automatically reset once the thermistors have cooled down (automatic RESET). 3RN2012 and 3RN2013 are non-volatile. This means a previous trip remains stored in the event of a control supply voltage failure – the thermistor motor protection relay remains in the safe state with an opened output relay until it is intentionally reset by pressing the TEST/RESET button of the unit or an external pushbutton.

3RN2023 "warning and disconnection" evaluation units

Two sensor circuits can be connected to one 3RN2023 evaluation unit that act on two separate output relays with 1 NO contact for warning and 1 CO contact for disconnection. Thermistors with different rated response temperatures TNF are used to implement the "Warning" and "Disconnection" functions. When sensor circuit 2 for "Warning" responds, a yellow LED is lit and when the "Disconnection" circuit responds, a red LED is lit. The sensor circuits have a different reset response and operating behavior: The "Warning" thermistor sensor circuit 2 (terminals 2T1, T2) works only with automatic RESET and according to the open-circuit principle (output relay K2, NO contact). The "Disconnection" thermistor sensor circuit 1 (terminals 1T1, T2) can be changed from manual RESET to automatic RESET by jumpering terminals Y1 and Y2. Remote RESET is implemented by connecting an external pushbutton with a normally-open function to these terminals.

Monitoring and control devices

Relays

SIRIUS 3RN2 thermistor motor protection

General data

Function diagrams

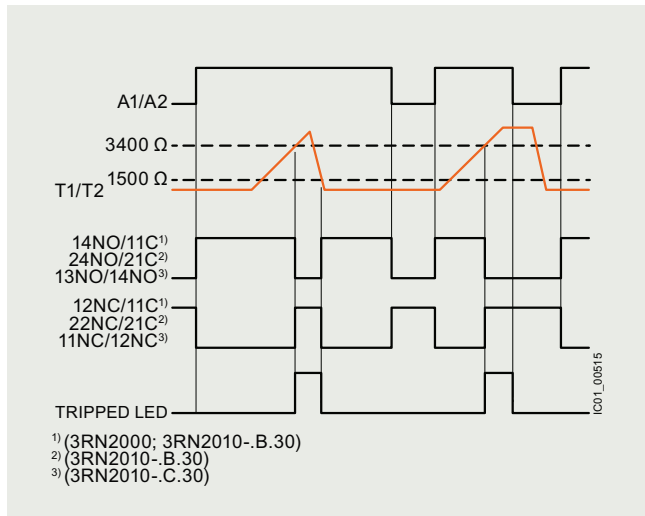

3RN2000, 3RN2010

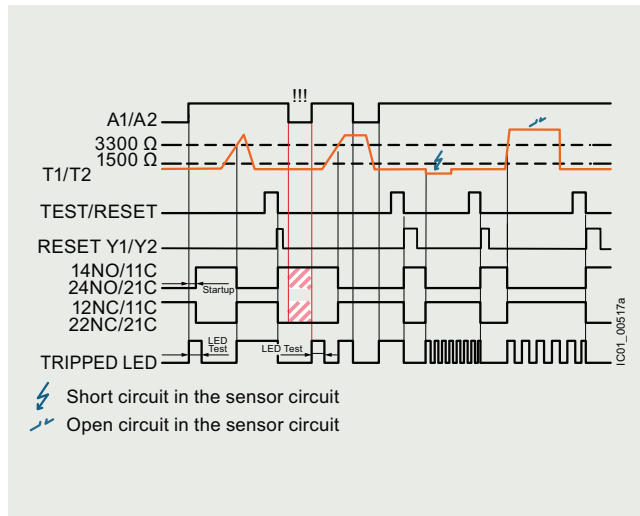

3RN2012-BW31: resetting via the TEST/RESET button or external pushbutton

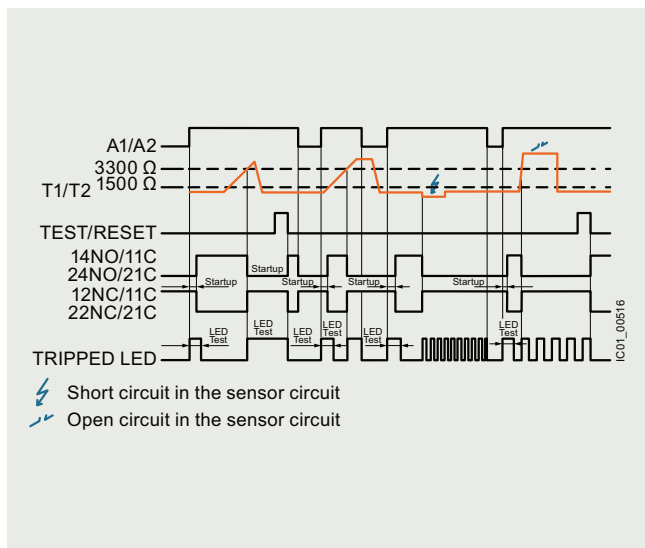

3RN2011: resetting via external pushbutton or interruption of the supply voltage

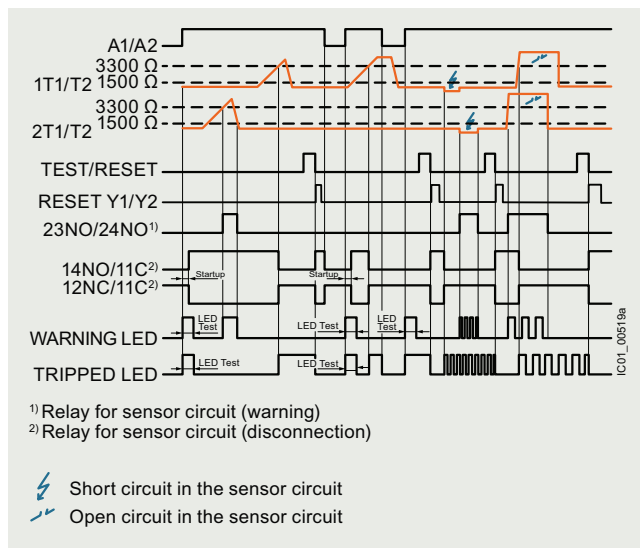

3RN2023: resetting via the TEST/RESET button or external pushbutton

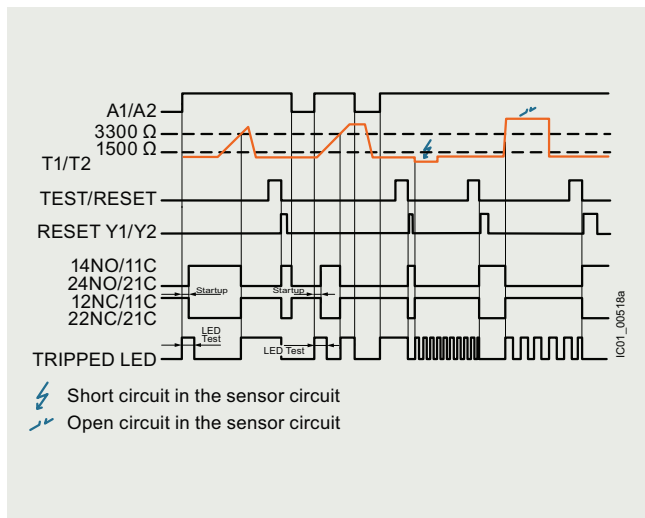

3RN2012-B.30, 3RN2013: resetting via the TEST/RESET button or external pushbutton

Article number	3RN2000-A, 3RN2010-C	3RN201.-B, 3RN2013-G, 3RN2023-D
Width x height x depth	17.5 x 100 x 90	22.5 x 100 x 90

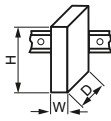

Article number	3RN2000- .AA30	3RN2000- .AW30, 3RN2010- .BW30, 3RN2010- .CW30	3RN2010- .BA30, 3RN2010- .CA30	3RN2011- .BA30, 3RN2012- .BA30	3RN2011- .BW30, 3RN2012- .BW30	3RN2012- .BW31	3RN2013- .BA30	3RN2013- .BW30, 3RN2013- .GW30	3RN2023- .DW30
----------------	---------------------------	---	---	---	---	---------------------------	---------------------------	---	---------------------------

General technical specifications		Without electrical separation		Electrical separation		Protective separation	
Type of electrical separation		Without electrical separation		Electrical separation		Protective separation	
Electrical endurance (operating cycles) at AC-15							
• At 24 V		100 000					
• At 230 V		--		100 000			
Mechanical endurance (operating cycles)		10 000 000					
Insulation voltage for overvoltage category III according to IEC 60664 for pollution degree 3, rated value	V	300					
Impulse withstand voltage, rated value	kV	4				6	
Minimum mains failure buffering time	ms	40					
Pollution degree		3					
Degree of protection IP		IP20					
Shock resistance according to IEC 60068-2-27		11 g/15 ms					
Vibration resistance according to IEC 60068-2-6		10 ... 55 Hz: 0.35 mm					
Type of mounting		Screw and snap-on mounting on 35 mm DIN rail					
• Mounting position		Any					
• Installation altitude at height above sea level, maximum	m	2 000					
Ambient temperature during operation	°C	-25 ... +60					
Relative humidity during operation, maximum	%	70					
ATEX				II 2G, II 2D			
Equipment group and category according to ATEX Product Directive 2014/34/EU		--		II 2G, II 2D		--	
Safety device type according to IEC 61508-2		--		Type B		--	
Safety Integrity Level (SIL) according to IEC 62061		--		SIL 1		--	
Performance Level (PL) according to ISO 13849-1		--		PL c		--	
T1 value for proof test interval or service duration according to IEC 61508	y	--		3		--	
T1 value for proof test interval or service duration according to IEC 61508		--		3		--	
Measuring circuit							
Number of measuring circuits		1				2	
Relative measurement accuracy	%	9		2			
Maximum number of sensors in series		6					
Cable length of sensor, maximum	m	2 800		250			
Thermistor resistance response value	Ω	1 500 ... 1 650		1 500 ... 1 550			
Thermistor resistance return value	Ω	3 400 ... 3 600		3 300 ... 3 350			



Monitoring and control devices

Relays

SIRIUS 3RN2 thermistor motor protection

General data

Article number	3RN2000- .AA30	3RN2000- .AW30, 3RN2010- .BW30, 3RN2010- .CW30	3RN2010- .BA30, 3RN2010- .CA30	3RN2011- .BA30, 3RN2012- .BA30	3RN2011- .BW30, 3RN2012- .BW30	3RN2012- .BW31	3RN2013- .BA30	3RN2013- .BW30, 3RN2013- .GW30	3RN2023- .DW30
Control circuit									
Current-carrying capacity of the output relay									
• At AC-15 at 250 V at 50/60 Hz	A	--	3						
• At DC-13 at 24 V	A	1							
• At DC-13 at 125 V	A	--	0.2						
• At DC-13 at 250 V	A	--	0.1						
Thermal current of the non-solid-state contact blocks, maximum	A	5							
Uninterrupted current of the output relay's DIAZED fuse link	A	6							
Supply voltage									
Control supply voltage rated value									
• At AC									
- At 50 Hz	V	24	24 ... 240	24	24 ... 240	24	24 ... 240	24	24 ... 240
- At 60 Hz	V	24	24 ... 240	24	24 ... 240	24	24 ... 240	24	24 ... 240
• At DC	V	24	24 ... 240	24	24 ... 240	24	24	24	24 ... 240
Operating range factor of the control supply voltage, rated value									
• At AC									
- At 50 Hz		0.85 ... 1.1							
- At 60 Hz		0.85 ... 1.1							
• At DC		0.85 ... 1.1							



Article number	3RN20..-1..3.	3RN20..-2..3.
Type of electrical connection	 Screw terminals	 Spring-loaded terminals (push-in)
Tightening torque	0.6 ... 0.8 Nm	--
Type of connectable conductor cross-sections		
• Solid	1 x (0.5 ... 4 mm ²), 2 x (0.5 ... 2.5 mm ²)	1 x (0.5 ... 4 mm ²)
• Finely stranded with end sleeve	1 x (0.5 ... 4 mm ²), 2 x (0.5 ... 1.5 mm ²)	1 x (0.5 ... 2.5 mm ²)
• For AWG cables		
- Solid	1 x (20 ... 12), 2 x (20 ... 14)	1 x (20 ... 12)
- Stranded	--	1 x (20 ... 12)

Selection and ordering data

PU (UNIT, SET, M) = 1
 PS* = 1 unit
 PG = 41H

Multi-unit packaging,
 see page 16/7.



Reset function	Number of CO contacts for auxiliary contacts	Number of NO contacts for auxiliary contacts	Number of NC contacts for auxiliary contacts	Material of switching contacts	Control supply voltage		Screw terminals 		Spring-loaded terminals (push-in) 	
					at AC at 50/60 Hz	at DC	Article No.	Price per PU	Article No.	Price per PU
					V	V				
Compact evaluation units, suitable for bimetallic switch										
Terminal A1 jumpered with root of changeover contact										
Automatic RESET	1	0	0	AgSnO2	24	24	3RN2000-1AA30		3RN2000-2AA30	
					24 ... 240	24 ... 240	3RN2000-1AW30		3RN2000-2AW30	
	0	1	1	AgSnO2	24	24	3RN2010-1CA30		3RN2010-2CA30	
					24 ... 240	24 ... 240	3RN2010-1CW30		3RN2010-2CW30	
Standard evaluation units, suitable for bimetallic switch										
Automatic RESET	2	0	0	AgSnO2	24	24	3RN2010-1BA30		3RN2010-2BA30	
					24 ... 240	24 ... 240	3RN2010-1BW30		3RN2010-2BW30	
Bistable evaluation units, open-circuit and short-circuit detection in the sensor circuit										
Does not trigger in the event of control supply voltage failure										
Automatic RESET, Manual RESET, External RESET, Fault storage	2	0	0	AgSnO2	24 ... 240	24 ... 240	3RN2012-1BW31		3RN2012-2BW31	
Standard evaluation units with ATEX approval, open-circuit and short-circuit detection in the sensor circuit¹⁾										
Manual RESET, External RESET	2	0	0	AgSnO2	24	24	3RN2011-1BA30		3RN2011-2BA30	
					24 ... 240	24 ... 240	3RN2011-1BW30		3RN2011-2BW30	
Non-volatile²⁾										
Automatic RESET, Manual RESET, External RESET, Fault storage	2 ³⁾	0	0	AgSnO2	24	24	3RN2012-1BA30		3RN2012-2BA30	
					24 ... 240	24 ... 240	3RN2012-1BW30		3RN2012-2BW30	
Protective separation, non-volatile²⁾⁴⁾										
Automatic RESET, Manual RESET, External RESET, Fault storage	2	0	0	AgSnO2	24	24	3RN2013-1BA30		3RN2013-2BA30	
					24 ... 240	24 ... 240	3RN2013-1BW30		3RN2013-2BW30	
				AgSnO2 Hard gold-plated	24 ... 240	24 ... 240	3RN2013-1GW30		3RN2013-2GW30	
Evaluation units with ATEX approval and 2 sensor circuits for warning and disconnection, open-circuit and short-circuit detection in both sensor circuits										
Protective separation, non-volatile²⁾⁴⁾										
Automatic RESET, Manual RESET, External RESET, Fault storage	1	1	0	AgSnO2	24 ... 240	24 ... 240	3RN2023-1DW30		3RN2023-2DW30	

¹⁾ For 3RN2011: The unit can be reset with the RESET button or by disconnecting the control supply voltage.

²⁾ Protection against voltage failure or non-volatile fault storage means that previous tripping due to a fault remains stored even if the control supply voltage fails. The monitoring device is not reset if the voltage fails. With an active fault, meaning a fault which has not been manually confirmed, an automatic restart of the plant upon recovery of the power is prevented therefore and plant safety increased as the result.

³⁾ Setting of output contacts in as-supplied state not defined (bistable relay). Application of the control supply voltage once results in contact changeover to the correct setting.

⁴⁾ Protective separation up to 300 V according to DIN/VDE 0160, IEC 60947-1.









Monitoring and control devices

Relays

SIRIUS 3RN2 thermistor motor protection

Accessories

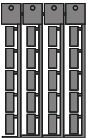
Selection and ordering data

Version	Article No.	Price per PU	PU (UNIT, SET, M)	PS*	PG
Terminals for SIRIUS devices in the industrial DIN-rail enclosure					
 3ZY1122-1BA00	Removable terminals, without inscription <ul style="list-style-type: none"> 2-pole, up to 1 x 4 mm² or 2 x 2.5 mm² 2-pole, up to 1 x 4 mm² or 2 x 1.5 mm² (in shared end sleeve) 	Screw terminals  3ZY1122-1BA00	1	6 units	41L
		Spring-loaded terminals (push-in)  3ZY1122-2BA00	1	6 units	41L
Accessories for enclosures					
 3ZY1311-0AA00	Push-in lugs for wall mounting (Two lugs are required per device)	3ZY1311-0AA00	1	10 units	41L
 3ZY1440-1AA00	Coding pins For removable terminals of SIRIUS devices in the industrial DIN-rail enclosure; enable the mechanical coding of terminals	3ZY1440-1AA00	1	12 units	41L
 3ZY1450-1AB00	Hinged cover Replacement covers, without terminal labeling, titanium gray <ul style="list-style-type: none"> 17.5 mm wide 22.5 mm wide 	3ZY1450-1AA00 3ZY1450-1AB00	1	5 units	41L
 3ZY1450-1AB00			1	5 units	41L
Blank labels					
 3RT2900-1SB20	Unit labeling plates¹⁾ For SIRIUS devices <ul style="list-style-type: none"> 10 mm x 7 mm, titanium gray 20 mm x 7 mm, titanium gray (Two lugs are required per device)	3RT2900-1SB10 3RT2900-1SB20	100	816 units	41B
			100	340 units	41B
Tools for opening spring-loaded terminals					
 3RA2908-1A	Screwdriver For all SIRIUS devices with spring-loaded terminals Length approx. 200 mm, 3.0 mm x 0.5 mm, titanium gray/black, partially insulated	Spring-loaded terminals (push-in)  3RA2908-1A	1	1 unit	41B

¹⁾ PC labeling system for individual inscription of unit labeling plates available from: murrplastik Systemtechnik GmbH, see page 16/18.

Overview



SIRIUS 3RS70 signal converters

More information

Homepage, see www.siemens.com/sirius-coupling-relays

SiePortal, see www.siemens.com/product_catalog_siep?3RS70

TIA Selection Tool Cloud (TST Cloud), see

www.siemens.com/tstcloud/?node=SIRIUSRelais

Conversion tool, see www.siemens.com/conversion-tool

Signal converters perform the coupling function for analog signals on both the input side and the output side. They are indispensable when processing analog values with electronic controls. Under harsh industrial conditions in particular, it is often necessary to transmit analog signals over long distances. Electrical separation is then needed as a result of the different power supplies. The resistance of the wiring causes potential differences and losses which must be prevented.

Electromagnetic interference and overvoltages can affect the signals on the input side in particular or even destroy the analog modules. All terminals of the 3RS70 signal converters are safe up to a voltage of 30 V DC and protected against switching poles. Short-circuit protection is an especially important function for the outputs.

The devices are EMC-tested according to

- IEC 61000-6-4 (generic standard regarding interference emission)
- IEC 61000-6-2 (generic standard for interference immunity)

The analog signals comply with

- IEC 60381-1/2

Article number scheme

Product versions		Article number	
Signal converters		3RS70 □ □ - □ □ □ 0 0	
Product function/type of input signal	Single-range converters, active	0 0	3-way separation, input 0 ... 10 V
		0 2	3-way separation, input 0 ... 20 mA,
		0 3	3-way separation, input 4 ... 20 mA,
	Multi-range converters, active, switchable	0 5	3-way separation, 3 standard signals can be switched 0 ... 10 V, 0/4 ... 20 mA
	Universal converters, active, switchable	0 6	3-way separation, 16 signals can be switched
	Single-range converters, passive	2 0	2-way separation, 4 ... 20 mA
	Multi-range converters, active, switchable	2 5	3-way separation, with manual/automatic switch and setting potentiometer
Connection type	Screw terminals	1	
	Spring-loaded terminals (push-in)	2	
Type of output signal	0 ... 10 V	A	
	0 ... 20 mA	C	
	4 ... 20 mA	D	
	Loop power isolator 4 ... 20 mA	E	
	3 standard signals can be switched	F	
	4 frequencies can be switched	K	
Supply voltage	24 V AC/DC	E	
	None	T	
	24 ... 240 V AC/DC	W	
Example	3RS70 0 0 - 1 A E 0 0		

Note:

The article number scheme shows an overview of product versions for better understanding of the logic behind the article numbers.

For your orders, please use the article numbers quoted in the selection and ordering data.

Monitoring and control devices

Relays

Coupling relays and signal converters

SIRIUS 3RS70 signal converters

Benefits

- Narrow width
- Easy-to-set universal converters
- Converters with frequency output
- All ranges are fully calibrated
- Universal family of devices – the perfect solution for every application
- Integrated manual/automatic switch with a setpoint generator
- Outputs are short-circuit proof
- Up to 30 V – protected against damage caused by wiring errors

Application

Signal converters are used in analog signal processing for

- Electrical separation
- Conversion of normalized and non-normalized signals
- Amplification and impedance adaptation
- Conversion to a frequency for processing by a digital input
- Overvoltage and EMC protection
- Short-circuit protection of the outputs

3RS7025 manual/automatic converter

For special applications in which analog signals have to be simulated, or during plant commissioning when the actual process value is not yet available, the 3RS7025 devices feature a setting potentiometer for manual setpoint selection and a manual/automatic switch.

The potentiometer for the 3RS7025 devices is used to simulate analog output signals when the changeover switch is set to "Manual" and the control supply voltage is applied, without the need for an analog input signal. The scale ranges from 0 to 100%.

Example: When it is set for an output of 4 to 20 mA, the left stop on the potentiometer represents an output current of 4 mA and the right stop represents an output current of 20 mA. In the "Auto" switch position, the output signal follows the input signal proportionally regardless of the potentiometer setting.

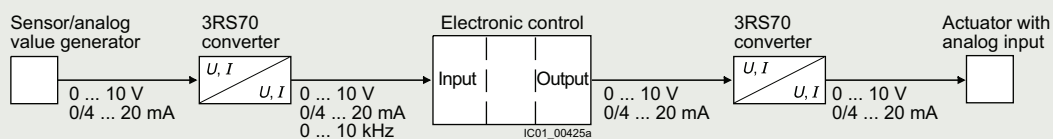

Application example of analog signal processing

Technical specifications

More information

Technical specifications, see
<https://support.industry.siemens.com/cs/ww/en/ps/16691/td>
Operating Instructions, see
<https://support.industry.siemens.com/cs/ww/en/view/109475738>

Internal circuit diagrams, see
<https://support.industry.siemens.com/cs/ww/en/view/109475738>

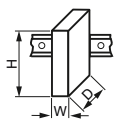
Article number	3RS7000-.AE00	3RS7002-.AE00, 3RS7003-.AE00	3RS7000-.CE00, 3RS7000-.DE00	3RS7002-.CE00, 3RS7002-.DE00, 3RS7003-.CE00, 3RS7003-.DE00	3RS7020-.ET00
Product designation	Single-range converters				Single-range converters
Product version	active				passive
General data					
Width x height x depth	 mm 6.2 x 93 x 72.5				6.2 x 93 x 71
Ambient temperature					
• During operation	°C	-25 ... +60			
• During storage	°C	-40 ... +80			
Relative humidity during operation	%	10 ... 95			
Insulation voltage for overvoltage category III according to IEC 60664 for pollution degree 3, rated value	V	50			
Active power input	W	0.29			
Degree of protection		IP20			
Input					
Input voltage, maximum	V	30			
Input impedance					
• Of current input, maximum	Ω	--	100	--	100
• Of voltage input, minimum	kΩ	330	--	330	--
Output					
Load					
• Maximum at current output	Ω	--	500		1 000
• Minimum at voltage output	kΩ	2	--		--
Relative measurement accuracy	%	0.1			
Short-circuit-proof		Yes			No

Monitoring and control devices



Relays

Coupling relays and signal converters

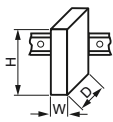
SIRIUS 3RS70 signal converters

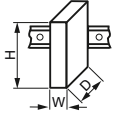
Article number		3RS7005- .FE00	3RS7005- .KE00	3RS7005- .FW00	3RS7005- .KW00	3RS7025- .FE00	3RS7025- .FW00
Product designation Product version		Multi-range converters, active, switchable				Multi-range converters, active, switchable, with manual/automatic switch and setting potentiometer	
General technical specifications							
Width x height x depth	 mm	6.2 x 93 x 72.5		17.5 x 93 x 72.5		17.5 x 93 x 75	
Ambient temperature							
• During operation	°C	-25 ... +60					
• During storage	°C	-40 ... +80					
Relative humidity during operation	%	10 ... 95					
Insulation voltage for overvoltage category III according to IEC 60664 for pollution degree 3, rated value	V	50		300		50	300
Active power input	W	0.29		0.5	0.34	0.5	
Degree of protection		IP20					
Input							
Input voltage, maximum	V	30					
Input impedance							
• Of current input, maximum	Ω	100					
• Of voltage input, minimum	kΩ	330					
Output							
Load							
• Maximum at current output	Ω	500	--	500	--	500	
• Minimum at voltage output	kΩ	2	--	2	--	2	
Relative measurement accuracy	%	0.1					
Short-circuit-proof		Yes					

Article number	3RS7006-FE00	3RS7006-FW00	
Product designation Product version	Universal converters active, switchable		
General technical specifications			
Width x height x depth	 mm	17.5 x 93 x 72.5	
Ambient temperature	°C	-25 ... +60	
• During operation	°C	-40 ... +80	
• During storage			
Relative humidity during operation	%	10 ... 95	
Insulation voltage for overvoltage category III according to IEC 60664 for pollution degree 3, rated value	V	50	300
Active power input	W	0.5	
Degree of protection		IP20	
Input			
Input voltage, maximum	V	30	
Input impedance			
• Of current input, maximum	Ω	100	
• Of voltage input, minimum	kΩ	330	
Output			
Load			
• Maximum at current output	Ω	500	
• Minimum at voltage output	kΩ	2	
Relative measurement accuracy	%	0.1	
Short-circuit-proof		Yes	

Article number	3RS70..-1....	3RS70..-2....
Type of electrical connection	 Screw terminals	 Spring-loaded terminals (push-in)
Type of connectable conductor cross-sections		
• Solid	1 x (0.25 ... 2.5 mm ²)	1 x (0.25 ... 2.5 mm ²)
• Finely stranded	--	1 x (0.25 ... 2.5 mm ²)
- Without end sleeve	1 x (0.25 ... 1.5 mm ²)	1 x (0.25 ... 1.5 mm ²)
- With end sleeve	1 x (20 ... 14)	1 x (20 ... 14)
• Solid for AWG cables		

Monitoring and control devices

Relays

Coupling relays and signal converters

SIRIUS 3RS70 signal converters

Selection and ordering data

PU (UNIT, SET, M) = 1
 PS* = 1 unit
 PG = 41H

Signal type		Supply voltage		Width	Screw terminals		Spring-loaded terminals (push-in)	
at the input	at the output	at 50/60 Hz AC	at DC		Article No.	Price per PU	Article No.	Price per PU
		V	V	mm				

Single-range converters

Passive

Type of electrical separation, 2-way

4 ... 20 mA	4 ... 20 mA	--	--	6.2	3RS7020-1ET00	3RS7020-2ET00
-------------	-------------	----	----	-----	---------------	---------------

Active

Type of electrical separation, 3-way

0 ... 10 V	0 ... 10 V	24	24	6.2	3RS7000-1AE00	3RS7000-2AE00
0 ... 20 mA	0 ... 10 V	24	24	6.2	3RS7002-1AE00	3RS7002-2AE00
4 ... 20 mA	0 ... 10 V	24	24	6.2	3RS7003-1AE00	3RS7003-2AE00
0 ... 10 V	0 ... 20 mA	24	24	6.2	3RS7000-1CE00	3RS7000-2CE00
0 ... 20 mA	0 ... 20 mA	24	24	6.2	3RS7002-1CE00	3RS7002-2CE00
4 ... 20 mA	0 ... 20 mA	24	24	6.2	3RS7003-1CE00	3RS7003-2CE00
0 ... 10 V	4 ... 20 mA	24	24	6.2	3RS7000-1DE00	3RS7000-2DE00
0 ... 20 mA	4 ... 20 mA	24	24	6.2	3RS7002-1DE00	3RS7002-2DE00
4 ... 20 mA	4 ... 20 mA	24	24	6.2	3RS7003-1DE00	3RS7003-2DE00



3RS7000-1AE00



3RS7000-2AE00

Multi-range converters

Active, switchable

Type of electrical separation, 3-way

0 ... 10 V,	0 ... 10 V,	24	24	6.2	3RS7005-1FE00	3RS7005-2FE00
0 ... 20 mA,	0 ... 20 mA,	24 ... 240	24 ... 240	17.5	3RS7005-1FW00	3RS7005-2FW00
4 ... 20 mA	4 ... 20 mA					
	0 ... 50 Hz,	24	24	6.2	3RS7005-1KE00	3RS7005-2KE00
	0 ... 100 Hz,	24 ... 240	24 ... 240	17.5	3RS7005-1KW00	3RS7005-2KW00
	0 ... 1 kHz,					
	0 ... 10 kHz					



3RS7005-1FW00

Active, switchable, with manual/automatic switch and setting potentiometer

Type of electrical separation, 3-way

0 ... 10 V,	0 ... 10 V,	24	24	17.5	3RS7025-1FE00	3RS7025-2FE00
0 ... 20 mA,	0 ... 20 mA,	24 ... 240	24 ... 240	17.5	3RS7025-1FW00	3RS7025-2FW00
4 ... 20 mA	4 ... 20 mA					

Universal converters

Active, switchable





Type of electrical separation, 3-way

0 ... 60 mV,	0 ... 10 V,	24	24	17.5	3RS7006-1FE00	3RS7006-2FE00
0 ... 100 mV,	0 ... 20 mA,	24 ... 240	24 ... 240	17.5	3RS7006-1FW00	3RS7006-2FW00
0 ... 300 mV,	4 ... 20 mA					
0 ... 500 mV,						
0 ... 1 V,						
0 ... 2 V,						
0 ... 5 V,						
0 ... 10 V,						
0 ... 20 V,						
2 ... 10 V,						
0 ... 5 mA,						
0 ... 10 mA,						
0 ... 20 mA,						
4 ... 20 mA,						
-5 ... +5 mA,						
-20 ... +20 mA						



3RS7006-1FE00

Accessories

Version	Article No.	Price per PU	PU (UNIT, SET, M)	PS*	PG
Potential barriers					
 3RQ3900-0A For electrical separation of different potentials when devices of different types are installed side by side	3RQ3900-0A		1	10 units	41H
Connecting combs					
 3RQ3901-0B For linking the same potentials, current carrying capacity for infeed max. 6 A <ul style="list-style-type: none"> • 2-pole • 4-pole • 8-pole • 16-pole 	3RQ3901-0A 3RQ3901-0B 3RQ3901-0C 3RQ3901-0D		1	10 units	41H
Clip-on labels					
 3RQ4902-0A For terminal and equipment labeling, white <ul style="list-style-type: none"> • 5 x 5 mm¹⁾ 	3RQ4902-0A		100	200 units	41H
Tools for opening spring-loaded terminals					
 3RA2908-1A Screwdriver For all SIRIUS devices with spring-loaded terminals Length approx. 200 mm, 3.0 mm x 0.5 mm, titanium gray/black, partially insulated	Spring-loaded terminals (push-in)  3RA2908-1A		1	1 unit	41B

¹⁾ PC labeling system for individual inscription of unit labeling plates available from: Conta-Clip Verbindungstechnik GmbH, see page 16/18.

Monitoring and control devices

Notes

10