







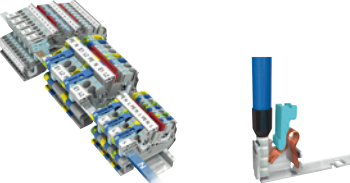

14/2	Introduction	14/104	8WH1 screw terminals
14/2	General data	14/104	Introduction
14/3	Support rails/protective conductor busbars	14/105	General data on 8WH
14/4	8WH order selection	14/106	8WH through-type terminals
		14/110	8WH fuse terminals
		14/112	8WH isolating blade terminals
		14/113	8WH isolating terminals
		14/114	8WH two-tier terminals
		14/117	8WH two-tier terminals with isolating function/isolating blade
		14/119	8WH measuring transformer terminals
		14/122	8WH diode terminals
		14/123	8WH two-tier diode terminals
		14/126	8WH high-current terminals
		14/130	8WH shield terminals
			Accessories for 8WH terminal blocks
		14/135	Accessories for labeling system
		14/136	Standard labeling system
		14/141	Mounting accessories
			8WA1 screw terminals
		14/144	Introduction
		14/145	General data on 8WA
		14/151	8WA through-type terminals
		14/157	8WA N-conductor isolating and branch terminals
		14/159	8WA Insta or three-tier terminals
		14/161	8WA two-tier terminals
		14/163	8WA two-tier terminals with electronic components
		14/165	8WA diode and isolating terminals
		14/166	8WA terminals for components
		14/167	8WA fuse terminals
		14/168	8WA through-type terminals with soldered and plug-in connection
		14/169	8WA measuring transformer terminals
			8WA2 spring-loaded terminals
		14/172	8WA initiator/actuator terminals
			Accessories for 8WA terminal blocks
		14/175	Accessories for labeling system
		14/176	Standard labeling system
		14/178	Mounting accessories
			For further technical product information:
			Siemens Industry Online Support: www.siemens.com/lowvoltage/product-support
			→ Entry type: Application example Certificate Characteristic Download FAQ Manual Product note Software archive Technical data
			Siemens LV 10 · 10/2017

Terminal Blocks

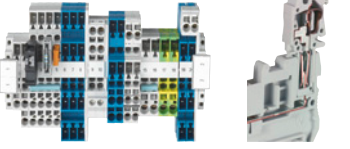
Introduction

General data

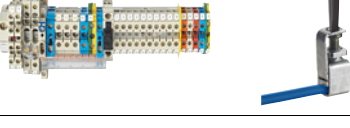
Overview

	Connection system	Page	Special features
8WH terminal blocks			
	8WH6 iPo plug-in terminals (iPo: in-Push-out)	14/9	The iPo connection method combines the advantages of spring-loaded and plug-in terminals – both rigid and flexible wires are easy to insert without the need for tools. Fast installation – with a minimum of effort and maximum contact stability.
	8WH6 iPo installation terminals	14/32	The iPo connection method combines the advantages of spring-loaded and plug-in terminals – both rigid and flexible wires are easy to insert without the need for tools. Fast installation – with a minimum of effort and maximum contact stability. Fast removal by simply pressing the unlatching button.
	8WH2 spring-loaded terminals	14/45	With the spring-loaded connection method, the tension spring exerts constant pressure on the conductor, which ensures excellent contact stability – even with applications subject to high levels of vibration. Fast removal by simply pressing the unlatching button.
	8WH5 combination plug-in terminals	14/84	Combination plug-in terminals are used where high availability is essential in the event of a fault. The contact system is able to withstand even extreme levels of vibration and both the terminal and the connector are fingerproof.
	8WH3 insulation displacement terminals	14/93	Thanks to the use of insulation displacement terminals, there is no need to strip the conductor. This ensures secure contact between the conductor and the connecting wire of the terminal.
	8WH1 screw terminals	14/104	The screw terminals have an impressively compact design and offer optimum handling. The elastic deformation capability of the terminal body prevents any creepage of the clamped conductor. Suitable for applications up to 1000 V DC.
	Accessories for 8WH	14/135	The 8WH accessories supplement the 8WH product range with the additional components required for installation.
8WA terminal blocks			
	8WA1 screw terminals	14/144	The tried and tested screw terminals are insulated on both sides and enclosed at both ends. These terminals are extremely robust and can withstand high mechanical and thermal loads.
	8WA2 spring-loaded terminals • 8WA2 initiator/actuator terminals	14/172	Fast and cost-effective connection of signal transmitters.
	Accessories for 8WA	14/175	The 8WA terminal block accessories supplement the 8WA product range with the additional components required for installation.

Rated short-time withstand current

Our terminals are able to withstand a rated short-time current corresponding to a current density of 120 A/mm² specific to the rated cross-section for one second.

Overview

Support rail type							Excerpt from IEC 60947-7-2/EN 60947-7-2/ VDE 0611 Part 3		
Width	Height	Thick- ness	Perforation type	Material	Surface	Rail profile	Short-circuit strength (Cu conductor)	Short-time withstand current, 1 s	Max. permissible thermal rated current with PEN function
mm	mm	mm					mm ² ¹⁾	kA	A
35	7.5	1.5	Non-perforated	Steel	Chromated	Standard mounting rail, acc. to EN 60715 – 35 × 7.5	16	1.92	¹⁾
35	7.5	1.5	Perforated	Steel	Chromated	Standard mounting rail, acc. to EN 60715 – 35 × 7.5	16	1.92	²⁾
35	7.5	1.5	Non-perforated	Steel	Galvanized	Standard mounting rail, dimensions acc. to EN 60 715 – 35 × 7.5	16	1.92	²⁾
35	7.5	1.5	Perforated	Steel	Galvanized	Standard mounting rail, dimensions acc. to EN 60 715 – 35 × 7.5	16	1.92	²⁾
35	7.5	1.5	Non-perforated	V2A high-grade steel	Chromated	Standard mounting rail, dimensions acc. to EN 60 715 – 35 × 7.5	16	1.92	²⁾
35	7.5	1.5	Non-perforated	Copper	Chromated	Standard mounting rail, dimensions acc. to EN 60 715 – 35 × 7.5	50	6.0	150
35	7.5	1.5	Non-perforated	Aluminum	Chromated	Standard mounting rail, dimensions acc. to EN 60 715 – 35 × 7.5	35	4.2	125
35	15	2.3	Non-perforated	Steel	Chromated	Standard mounting rail, acc. to EN 60 715 – 35 × 15	50	6.0	²⁾
35	15	1.5	Non-perforated	Steel	Chromated	Standard mounting rail, similar to EN 60 715 – 35 × 15	35	4.2	²⁾
35	15	1.5	Perforated	Steel	Chromated	Standard mounting rail, similar to EN 60 715 – 35 × 15	35	4.2	²⁾
35	15	1.5	Non-perforated	Steel	Galvanized	Standard mounting rail, similar to EN 60 715 – 35 × 15	35	4.2	²⁾
35	15	1.5	Perforated	Steel	Galvanized	Standard mounting rail, similar to EN 60 715 – 35 × 15	35	4.2	²⁾
35	15	1.5	Non-perforated	Copper	Chromated	Standard mounting rail, similar to EN 60 715 – 35 × 15	95	11.4	232
35	15	1.5	Non-perforated	Aluminum	Chromated	Standard mounting rail, similar to EN 60 715 – 35 × 15	70	8.4	192

¹⁾ Cross-sections calculated acc. to IEC 60439-1 / EN 60439-1 / EN 60439-1 / VDE 0660 Part 500.

²⁾ Steel protective conductor busbars are not permissible for PEN function.

Terminal Blocks

Introduction

8WH order selection

Terminal type	Connection type	Design	Number of terminals	Version	MLFB digits		
					1...9	8...12	
Installation terminals	iPo	Standard	2	L	8WH6001-		
			4	L/L	8WH6001-		
			4	L/N	8WH6001-		
			5	PE/L/L	8WH6001-		
			5	PE/L/N	8WH6001-		
			5	PE/L/NT	8WH6001-		
			5	PE/L/N isolating blade	8WH6001-		
			5	PE/L/L isolating blade	8WH6001-		
			5	PE/L/L through-type term. for isolat. term.	8WH6001-		
			5	PE/L/L isolation	8WH6001-		
	Spring-loaded terminals	Two-tier		4	L/PE	8WH2020-	
				4	N/PE	8WH2020-	
				4	N/L	8WH2020-	
		Three-tier		6	PE/L/N	8WH2030-	
				6	PE/L/L	8WH2030-	

14

Article No., e.g.

8WH6001-

4FF00

Insta terminal: Plug-in design · 5 connection points
2.5 mm² · Range of functions

The table above uses a sample order to provide an initial overview of the article numbering system for iPo installation terminals.

This table does not, however, show the complete range of 8WH iPo installation terminals.

	1.5 mm ²			2.5 mm ²				4 mm ²		
	Through-type terminal, gray	Through-type terminal, blue	PE terminal, green/yellow	Through-type terminal, gray	Through-type terminal, blue	PE terminal	Terminals with range of functions	Through-type terminal, gray	Through-type terminal, blue	PE terminal, green/yellow
							4QF00			
							4DF00			
							4CF00			
							4HF00			
							4EF00			
							4FF00			
							4GF00			
							4NF00			
							4PF00			
							4MF00			
							4AF00			
							4BF00			
							4CF00			
							4EF00			
							4HF00			

I201_18327a

Terminal Blocks

Introduction

8WH order selection

Connection type	Terminals	Design	Number of terminals MLFB digits 1...7 MLFB digits 8...12		1.5 mm ²				2.5 mm ²						
					Through-type terminal, gray	Through-type terminal, colored	Through-type terminal, blue	PE terminal, green/yellow	Through-type terminal, gray	Through-type terminal, colored	Through-type terminal, blue	Instrument isolating terminal, blue	Isolating terminal, gray	Instrument isolating terminal, gray	PE terminal, green/yellow
Screw terminal	Standard		2	8WH1000-					0AF00		0AF01				0CF07
		Two-tier	4	8WH1020-					0AF00		0AF01				0CF07
		Two-tier	4	8WH1025-					0AF00						
Spring-loaded terminals	Standard		2	8WH2000-	OAE00	OAE0 ¹⁾	OAE01	OCE07	0AF00	0AF0 ¹⁾	0AF01		6AF00	6CF00	0CF07
			3	8WH2003-	OAE00		OAE01	OCE07	0AF00		0AF01		6AF00	6CF00	0CF07
			4	8WH2004-	OAE00		OAE01	OCE07	0AF00		0AF01	6CF01	6AF00	6CF00	0CF07
		Two-tier	4	8WH2020-	OAE00		OAE01	OCE07	0AF00		0AF01				0CF07
			6	8WH2023-					0AF00		0AF01				0CF07
		Two-tier 1 pol.	6	8WH2022-					0AF00						
			4	8WH2025-	OAE00				0AF00		0AF01				
		Three-tier	6	8WH2030-					0AF00		0AF01				
		Three-tier	6	8WH2035-					0AF00						0CF07
		Four-tier	8	8WH2040-					4LF00						
	Molded-case		2	8WH2500-					0AF00		0AF01		6AF00	6CF00	0CF07
			3	8WH2503-					0AF00		0AF01				0CF07
			4	8WH2504-					0AF00		0AF01				0CF07
		Two-tier	4	8WH2520-					0AF00		0AF01				0CF07
iPo	Standard		2	8WH6000-					0AF00		0AF01				0CF07
			3	8WH6003-					0AF00		0AF01				0CF07
			4	8WH6004-					0AF00		0AF01				0CF07
		Two-tier	4	8WH6020-					0AF00		0AF01				0CF07
Combination plugs	Standard		2	8WH5000-					0AF00		0AF01				0CF07
			4	8WH5004-					0AF00		0AF01				0CF07
Insulation displacement terminal technology (IDC)	Standard		2	8WH3000-	OAE00		OAE01	OCE07	0AF00		0AF01				0CF07
			3	8WH3003-	OAE00		OAE01	OCE07	0AF00		0AF01				0CF07
			4	8WH3004-	OAE00		OAE01	OCE07							
		Two-tier	4	8WH3020-	OAE00		OAE01	OCE07							

Article No., e.g.

8WH2500-

0AF00

Standard terminal: Spring-loaded terminal · compact · 2 connection points · 2.5 mm² · Through-type terminal, gray

The table above uses a sample order to provide an initial overview of the article numbering system.





This table does not, however, show the complete 8WH range.

Terminal Blocks

Notes

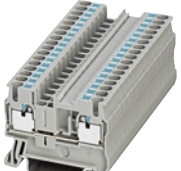
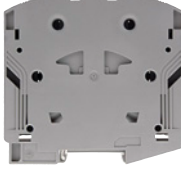
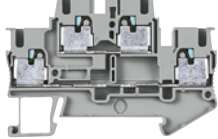
14

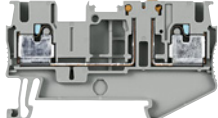
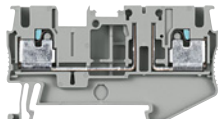
Overview

	Devices	Page	Function
	Through-type terminals	14/11	Connection of incoming and outgoing conductors
	Through-type terminals (high-current terminals) NEW	14/18	Connection of incoming and outgoing conductors with larger cross-sections 50 ... 150 mm ²
	Two-tier terminals	14/21	Compact form of the terminal blocks in which two connection wires can be installed
	Fuse terminals	14/23	Terminals which can be used to protect control circuits, for example
	Isolating blade terminals	14/24	Isolation of the circuit, e.g. for test purposes
	Isolating terminals	14/26	Isolation of the circuit, e.g. for test purposes
	8WH6 initiator-actuator terminals NEW	14/28	Fast and cost-effective connection of signal transmitters to the controller

Terminal Blocks

8WH6 iPo Plug-In Terminals

General data

Overview

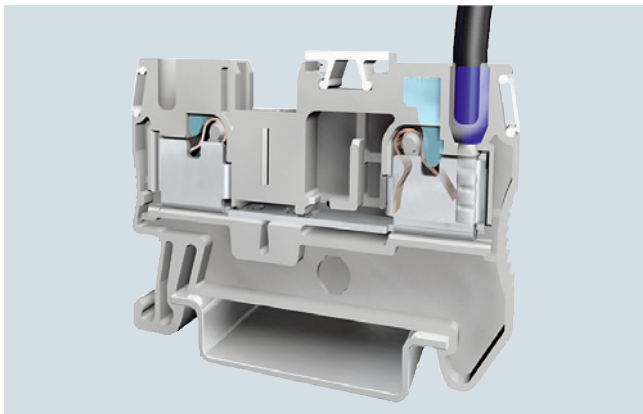

iPo connection method: Characterized by its simple and direct conductor connection, this series utilizes all the benefits of the 8WH system.

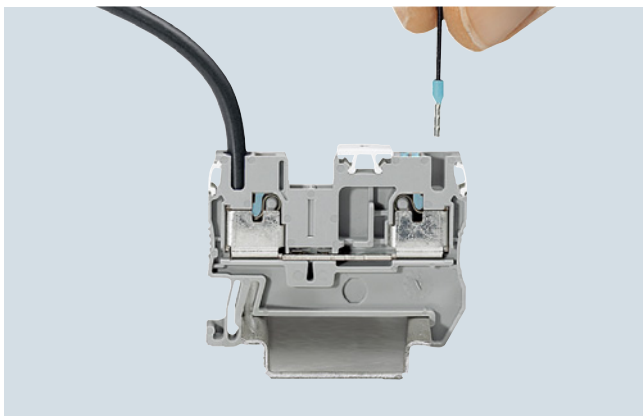

Super-light insertion: With an up to 50% lower insertion force, the iPo connection method permits easy and direct insertion of rigid and flexible conductors with end sleeves with a cross-section of more than 0.34 mm^2 .

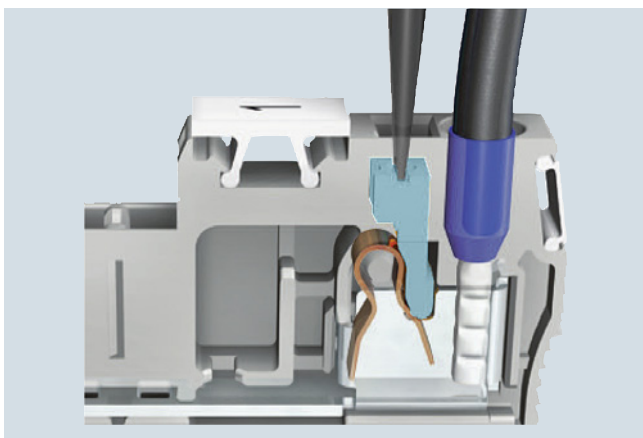

Pusher button function: The actuation button is used to open the spring to either release the conductor or to connect smaller cross-sections from 0.14 mm^2 . It can be operated by any tool.

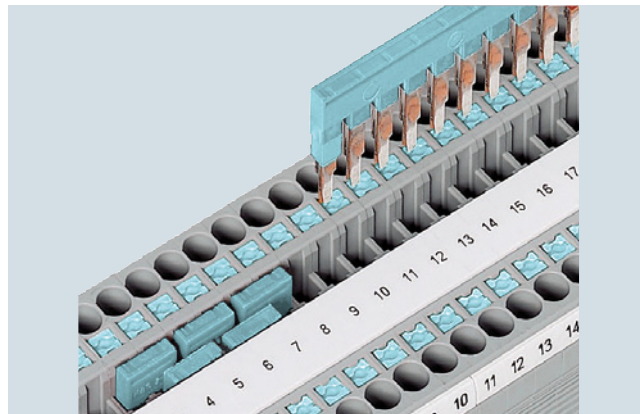

Easy bridging: The double bridge shaft supports the interconnection of any number of terminals using 2-pole jumpers. The 2-pole to 50-pole jumpers enable up to 50 terminals to be connected in a single step.

Overview



8WH6 through-type terminals are ideal for the direct tool-free wiring of conductors with end sleeve or rigid conductors. Easy insertion of flexible conductors with end sleeves upwards of 0.34 mm^2 . The actuation button can be used to open the clamping point with any type of screwdriver in order to unwire or wire small conductors. The compact design and front connection permit wiring in the narrowest of spaces. The double bridge shaft enables fast creation of an individual potential distribution and infeed, e.g. using a screw terminal.

A label can be snapped on to the middle of each terminal at the front. Further labels can also be mounted flat on the side of the terminals.

Technical specifications

	8WH6000-0AF00 8WH6000-0AF01 2.5 mm ²	8WH6003-0AF00 8WH6003-0AF01 2.5 mm ²	8WH6004-0AF00 8WH6004-0AF01 2.5 mm ²
Dimensions			
• Width / length / height (NS 35/7.5) in mm	5.2 / 48.5 / 36.5	5.2 / 60.5 / 36.5	5.2 / 72 / 36.5
Max. technical specifications			
• I_{max} in A	30	30 ¹⁾	
• U_{max} in V	800		
• Max. Ø in mm ²	0.14 ... 4		
• AWG	26 ... 12		
Rating according to IEC 60947-7-1			
• Rated voltage in V (IEC / UL/CSA)	800 / 600		800 / --
• Rated current in A / cross-section in mm ²			
- IEC	24 / 2.5	24 ¹⁾ / 2.5	--
- UL/CSA	20 / --		--
• Rated cross-section in mm ²	2.5		
• AWG cross-section range (IEC / UL/CSA)	26 ... 12 / 24 ... 12		26 ... 12 / --
Connection capacities			
• 1 conductor			
- Rigid in mm ²	0.14 ... 4		
- Flexible in mm ²	0.14 ... 2.5		
- End sleeve with/without plastic sleeve in mm ²	0.14 ... 2.5		
• Conductor cross-section, direct plug-in			
- Rigid in mm ²	0.34 ... 4		
- End sleeve with/without plastic sleeve in mm ²	0.34 ... 2.5		
General data			
• Stripped length in mm	10		
• Molded plastic	PA		
• Flammability Class acc. to UL 94	V0		

¹⁾ The total current through all connected conductors must not exceed the maximum load current.

Terminal Blocks

8WH6 iPo Plug-In Terminals

8WH6 through-type terminals

	8WH6000-OCF07 2.5 mm ²	8WH6003-OCF07 2.5 mm ²	8WH6004-OCF07 2.5 mm ²
Dimensions			
• Width / length / height (NS 35/7.5) in mm	5.2 / 48.5 / 36.5	5.2 / 60.5 / 36.5	5.2 / 72 / 36.5
Max. technical specifications			
• Max. Ø in mm ²	0.14 ... 4		
• AWG	26 ... 12		
Rating according to IEC 60947-7-1			
• Rated cross-section in mm ²	2.5		
• AWG cross-section range (IEC / UL/CSA)	26 ... 12 / 24 ... 12		26 ... 12 / --
Connection capacities			
• 1 conductor			
- Rigid in mm ²	0.14 ... 4		
- Flexible in mm ²	0.14 ... 2.5		
- End sleeve with/without plastic sleeve in mm ²	0.14 ... 2.5		
• Conductor cross-section, direct plug-in			
- Rigid in mm ²	0.34 ... 4		
- End sleeve with/without plastic sleeve in mm ²	0.34 ... 2.5		
General data			
• Stripped length in mm	10		
• Molded plastic	PA		
• Flammability Class acc. to UL 94	V0		

	8WH6000-OAG00 8WH6000-OAG01 4 mm ²	8WH6003-OAG00 8WH6003-OAG01 4 mm ²	8WH6004-OAG00 8WH6004-OAG01 4 mm ²
Dimensions			
• Width / length / height in mm	6.2 / 56 / 36.5	6.2 / 66.5 / 36.5	6.2 / 77 / 36.5
Max. technical specifications			
• I_{max} in A	38	38 ¹⁾	38 ¹⁾
• U_{max} in V	800	800	800
• Max. Ø in mm ²	0.2 ... 6	0.2 ... 6	0.2 ... 6
• AWG	24 ... 10	24 ... 10	24 ... 10
Rating according to IEC 60947-7-1			
• Rated voltage in V (IEC / UL/CSA)	800 / 600	800 / 600	800 / 600
• Rated current in A / cross-section in mm ²			
- IEC	32 / 4	32 ¹⁾ / 4	32 ¹⁾ / 4
- UL/CSA	30 / --	30 / --	30 / --
• Rated cross-section in mm ²	4	4	4
• AWG cross-section range (IEC / UL/CSA)	24 ... 10 / 24 ... 10	24 ... 10 / 24 ... 10	24 ... 10 / 24 ... 10
Connection capacities			
• 1 conductor			
- Rigid in mm ²	0.2 ... 6	0.2 ... 6	0.2 ... 6
- Flexible in mm ²	0.2 ... 4	0.2 ... 4	0.2 ... 4
- End sleeve with/without plastic sleeve in mm ²	0.25 ... 4	0.25 ... 4	0.25 ... 4
• Conductor cross-section, direct plug-in			
- Rigid in mm ²	0.5 ... 6	0.5 ... 6	0.5 ... 6
- End sleeve with/without plastic sleeve in mm ²	0.5 ... 4	0.5 ... 4	0.5 ... 4
General data			
• Stripped length in mm	12	12	12
• Molded plastic	PA	PA	PA
• Flammability Class acc. to UL 94	V0	V0	V0

¹⁾ The total current through all connected conductors must not exceed the maximum load current.

	8WH6000-OCG07 4 mm ²	8WH6003-OCG07 4 mm ²	8WH6004-OCG07 4 mm ²
Dimensions			
• Width / length / height (NS 35/7.5) in mm	6.2 / 56 / 36.5	6.2 / 66.5 / 36.5	6.2 / 77 / 36.5
Max. technical specifications			
• Max. Ø in mm ²	0.2 ... 6	0.2 ... 6	0.2 ... 6
• AWG	24 ... 10	24 ... 10	24 ... 10
Rating according to IEC 60947-7-1			
• Rated cross-section in mm ²	4	4	4
• AWG cross-section range (IEC / UL/CSA)	24 ... 10 / 24 ... 10	24 ... 10 / 24 ... 10	24 ... 10 / 24 ... 10
Connection capacities			
• 1 conductor			
- Rigid in mm ²	0.2 ... 6	0.2 ... 6	0.2 ... 6
- Flexible in mm ²	0.2 ... 4	0.2 ... 6	0.2 ... 6
- End sleeve with/without plastic sleeve in mm ²	0.25 ... 4	0.2 ... 4	0.2 ... 4
• Conductor cross-section, direct plug-in			
- Rigid in mm ²	0.5 ... 6		
- End sleeve with/without plastic sleeve in mm ²	0.5 ... 4		
General data			
• Stripped length in mm	12	12	12
• Molded plastic	PA	PA	PA
• Flammability Class acc. to UL 94	V0	V0	V0

	8WH6000-0AH00 8WH6000-0AH01 6 mm ²	8WH6000-0CHO 6 mm ²	8WH6000-0AJ00 8WH6000-0AJ01 10 mm ²	8WH6000-0CJ07 10 mm ²
Dimensions				
• Width/length/cover width in mm	8.2 / 57.7 / 2.2	8.2 / 57.7 / 2.2	8.2 / 57.7 / 2.2	8.2 / 57.7 / 2.2
• Height (NS 35/7.5 / NS 35/15) in mm	43.5 / 51	43.5 / 51	43.5 / 51	43.5 / 51
Technical specifications acc. to IEC/DIN VDE				
• Max. load current in A / cross-section in mm ²	51 / 10	--	65 / 16	--
• Rated voltage in V	1000	--	1000	--
• Rated impulse withstand voltage in kV / pollution degree	8 / 3	8 / 3	8 / 3	8 / 3
• Overvoltage category / molded plastic group	III / I	III / I	III / I	III / I
Connection capacities				
• Flexible with end sleeve, with plastic sleeve in mm ²	0.5 ... 6	0.5 ... 6	0.5 ... 10	0.5 ... 10
• Flexible with end sleeve, without plastic sleeve in mm ²	0.5 ... 6	0.5 ... 6	0.5 ... 10	0.5 ... 10
• Rigid in mm ²	0.5 ... 10	0.5 ... 10	0.5 ... 16	0.5 ... 16
• Flexible in mm ²	0.5 ... 6	0.5 ... 6	0.5 ... 10	0.5 ... 10
Stripped length in mm	12	12	18	18
Plug gauge (IEC 60947-1)	A5	A5	A6	A6
Molded plastic type	PA	PA	PA	PA
• Flammability Class acc. to UL 94	V0	V0	V0	V0
Approval data (UL/cUL and CSA)				
• Rated voltage / rated current / conductor sizes				
- UL/cUL: in V / A / AWG	600 / 40 / 20 ... 8	-- / -- / 20 ... 8	600 / 60 / 20 ... 6	-- / -- / 20 ... 6
- CSA: in V / A / AWG	--	--	--	--

	8WH6000-0AK00 8WH6000-0AK01 16 mm ²	8WH6000-0CK07 16 mm ²	8WH6000-0AM00 8WH6000-0AM01 35 mm ²	8WH6000-0CM07 35 mm ²
Dimensions				
• Width/length/cover width in mm	12.2 / 75.4 / 2.2	12.2 / 75.4 / 2.2	16 / 91.6 / 2.2	16 / 91.6 / 2.2
• Height (NS 35/7.5 / NS 35/15) in mm	52.6 / 60.1	52.6 / 60.1	-- / 62.3	-- / 62.3
Technical specifications acc. to IEC/DIN VDE				
• Max. load current in A / cross-section in mm ²	90 / 25	--	125 / 35	--
• Rated voltage in V	1000	--	1000	--
• Rated impulse withstand voltage in kV / pollution degree	8 / 3	8 / 3	8 / 3	8 / 3
• Overvoltage category / molded plastic group	III	III	III	III
Connection capacities				
• Flexible with end sleeve, with plastic sleeve in mm ²	0.5 ... 16	0.5 ... 16	6 ... 35	6 ... 35
• Flexible with end sleeve, without plastic sleeve in mm ²	0.5 ... 16	0.5 ... 16	6 ... 35	6 ... 35
• Rigid in mm ² / AWG	0.5 ... 25 / 20 ... 4	0.5 ... 25 / 20 ... 4	6 ... 35 / 10 ... 2	6 ... 35 / 10 ... 2
• Flexible in mm ² / AWG	0.5 ... 16 / 20 ... 6	0.5 ... 16 / 20 ... 6	6 ... 35 / 10 ... 2	6 ... 35 / 10 ... 2
Stripped length in mm	18	18	25	25
Plug gauge (IEC 60947-1)	A7	A7	--	--
Molded plastic type	PA	PA	PA	PA
• Flammability Class acc. to UL 94	V0	V0	V0	V0
Approval data (UL/cUL and CSA)				
• Rated voltage / rated current / conductor sizes				
- UL/cUL: in V/A / AWG	--	--	--	--
- CSA: in V/A / AWG	--	--	--	--

Selection and ordering data

Version	SD	Article No. www.siemens.com/ product?ArticleNo.	Price per PU	PU (UNIT, SET, M)	PS	PG
	d					

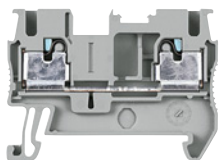
Terminal size 2.5 mm²

8WH6000-0AF00

Through-type terminals, terminal size 2.5 mm²

- C_{US}
- Terminal width 5.2 mm
- I_{max} = 30 A
- U_{max} = 800 V
- AWG 26 ... 12
- Connection capacity, one conductor
 - Rigid 0.14 ... 4 mm²
 - Flexible 0.14 ... 2.5 mm²

Versions







- Two clamping points
 - Gray
 - Blue
- Three clamping points
 - Gray
 - Blue
- Four clamping points
 - Gray
 - Blue

8WH6000-0AF00	1	50 units	1BT
8WH6000-0AF01	1	50 units	1BT
8WH6003-0AF00	1	50 units	1BT
8WH6003-0AF01	1	50 units	1BT
8WH6004-0AF00	1	50 units	1BT
8WH6004-0AF01	1	50 units	1BT

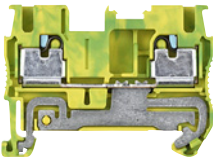
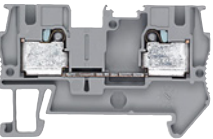
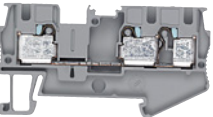
Terminal Blocks

8WH6 iPo Plug-In Terminals

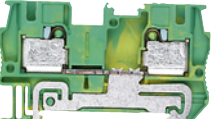
8WH6 through-type terminals

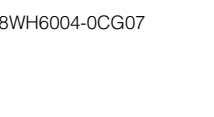
Version	SD	Article No. www.siemens.com/ product?Article No.	Price per PU	PU (UNIT, SET, M)	PS	PG
d						
 <p>8WH6000-OCF07</p>		<p>PE through-type terminals, terminal size 2.5 mm²</p> <ul style="list-style-type: none"> • C_{max} US • Terminal width 5.2 mm • AWG 26 ... 12 • Connection capacity, one conductor <ul style="list-style-type: none"> - Rigid 0.14 ... 4 mm² - Flexible 0.14 ... 2.5 mm² • Green-yellow 				
<p>Versions</p> <ul style="list-style-type: none"> • Two clamping points • Three clamping points • Four clamping points 		<p>8WH6000-OCF07</p> <p>8WH6003-OCF07</p> <p>8WH6004-OCF07</p>		<p>1 50 units</p> <p>1 50 units</p> <p>1 50 units</p>	<p>1BT</p> <p>1BT</p> <p>1BT</p>	
Terminal size 4 mm²						
 <p>8WH6000-0AG00</p>		<p>Through-type terminals, terminal size 4 mm²</p> <ul style="list-style-type: none"> • C_{max} US • Terminal width 6.2 mm • $I_{\text{max}} = 38 \text{ A}$ • $U_{\text{max}} = 800 \text{ V}$ • AWG 24 ... 10 • Connection capacity, one conductor <ul style="list-style-type: none"> - Rigid 0.2 ... 6 mm² - Flexible 0.2 ... 4 mm² 				
 <p>8WH6003-0AG00</p>		<p>Versions</p> <ul style="list-style-type: none"> • Two clamping points <ul style="list-style-type: none"> - Gray - Blue • Three clamping points <ul style="list-style-type: none"> - Gray - Blue • Four clamping points <ul style="list-style-type: none"> - Gray - Blue 	<p>8WH6000-0AG00</p> <p>8WH6000-0AG01</p>	<p>1 50 units</p> <p>1 50 units</p>	<p>1BT</p> <p>1BT</p>	
 <p>8WH6003-0AG01</p>			<p>8WH6003-0AG00</p> <p>8WH6003-0AG01</p>	<p>1 50 units</p> <p>1 50 units</p>	<p>1BT</p> <p>1BT</p>	
 <p>8WH6003-0AG01</p>			<p>8WH6004-0AG00</p> <p>8WH6004-0AG01</p>	<p>1 50 units</p> <p>1 50 units</p>	<p>1BT</p> <p>1BT</p>	
 <p>8WH6004-0AG00</p>						
 <p>8WH6004-0AG01</p>						
 <p>8WH6000-0CG07</p>		<p>PE through-type terminals, terminal size 4 mm²</p> <ul style="list-style-type: none"> • C_{max} US • Terminal width 6.2 mm • AWG 24 ... 10 • Connection capacity, one conductor <ul style="list-style-type: none"> - Rigid 0.2 ... 6 mm² - Flexible 0.2 ... 4 mm² • Green-yellow 				
 <p>8WH6003-0CG07</p>		<p>Versions</p> <ul style="list-style-type: none"> • Two clamping points • Three clamping points • Four clamping points 	<p>8WH6000-0CG07</p> <p>8WH6003-0CG07</p> <p>8WH6004-0CG07</p>	<p>1 50 units</p> <p>1 50 units</p> <p>1 50 units</p>	<p>1BT</p> <p>1BT</p> <p>1BT</p>	
 <p>8WH6004-0CG07</p>						

Terminal Blocks

8WH6 iPo Plug-In Terminals



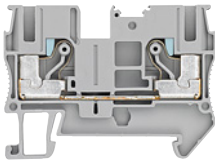
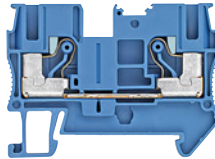
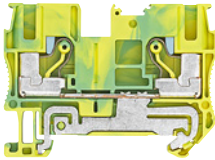
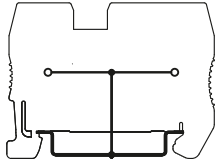
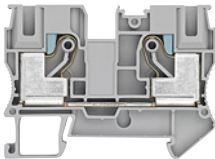
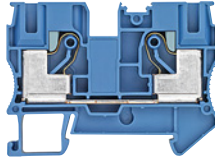
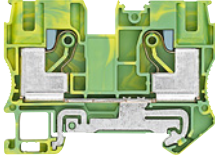
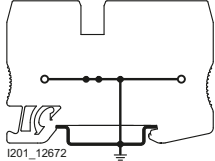

8WH6 through-type terminals



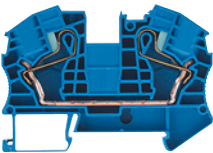

Version	SD	Article No. www.siemens.com/ product?Article No.	Price per PU	PU (UNIT, SET, M)	PS	PG
d						
Terminal size 6 mm²						
 8WH6000-0AH00  8WH6000-0AH01	Through-type terminals, terminal size 6 mm², two clamping points <ul style="list-style-type: none"> Terminal width 8.2 mm • C_{Δ} I_{Δ} U_{Δ} • IEC 60947-7-1 <ul style="list-style-type: none"> - Rigid 0.5 ... 10 mm² - Flexible 0.5 ... 6 mm² - AWG 20 ... 8 - $I = 41$ A - $U = 1000$ V 					
Versions						
<ul style="list-style-type: none"> • Gray • Blue 		8WH6000-0AH00 8WH6000-0AH01		1 50 units 1BT 1 50 units 1BT		
 8WH6000-0CH07  <small>I201_12670</small> 8WH6000-0CH07	PE through-type terminals, terminal size 6 mm², two clamping points <ul style="list-style-type: none"> Terminal width 8.2 mm • C_{Δ} I_{Δ} U_{Δ} • IEC 60947-7-2 <ul style="list-style-type: none"> - Rigid 0.5 ... 10 mm² - Flexible 0.5 ... 6 mm² - AWG 20 ... 8 • Green-yellow 					
		8WH6000-0CH07		1 50 units 1BT		
Terminal size 10 mm²						
 8WH6000-0AJ00  8WH6000-0AJ01	Through-type terminals, terminal size 10 mm² <ul style="list-style-type: none"> Terminal width 10.2 mm • C_{Δ} I_{Δ} U_{Δ} • IEC 60947-7-1 <ul style="list-style-type: none"> - Rigid 0.5 ... 16 mm² - Flexible 0.5 ... 6 mm² - AWG 20 ... 6 - $I = 57$ A - $U = 1000$ V 					
Versions						
<ul style="list-style-type: none"> • Gray • Blue 		8WH6000-0AJ00 8WH6000-0AJ01		1 50 units 1BT 1 50 units 1BT		
 8WH6000-0CJ07  <small>I201_12672</small> 8WH6000-0CJ07	PE through-type terminals, terminal size 10 mm² <ul style="list-style-type: none"> Terminal width 10.2 mm • C_{Δ} I_{Δ} U_{Δ} • IEC 60947-7-2 <ul style="list-style-type: none"> - Rigid 0.5 ... 10 mm² - Flexible 0.5 ... 10 mm² - AWG 20 ... 6 • Green-yellow 					
		8WH6000-0CJ07		1 50 units 1BT		

Terminal Blocks

8WH6 iPo Plug-In Terminals

8WH6 through-type terminals

Version	SD	Article No. www.siemens.com/ product?Article No.	Price per PU	PU (UNIT, SET, M)	PS	PG
d						
Terminal size 16 mm²						
 8WH6000-0AK00	Through-type terminals, terminal size 16 mm² <ul style="list-style-type: none"> Terminal width 12.2 mm IEC 60947-7-1 <ul style="list-style-type: none"> Rigid 0.5 ... 25 mm² Flexible 0.5 ... 16 mm² AWG 20 ... 4 I = 90 A U = 1000 V 					
 8WH6000-0AK01	Versions <ul style="list-style-type: none"> Gray Blue 	8WH6000-0AK00 8WH6000-0AK01				
 8WH6000-0CK07	PE through-type terminals, terminal size 16 mm² <ul style="list-style-type: none"> Terminal width 12.2 mm IEC 60947-7-2 <ul style="list-style-type: none"> Rigid 0.5 ... 25 mm² Flexible 0.5 ... 16 mm² AWG 20 ... 4 Green-yellow 					
Terminal size 35 mm²						
 8WH6000-0AM00	Through-type terminals, terminal size 35 mm² <ul style="list-style-type: none"> Terminal width 16 mm Enclosed at both ends IEC 60947-7-1 <ul style="list-style-type: none"> Rigid 6 ... 35 mm² Flexible 6 ... 35 mm² AWG 10 ... 2 I = 125 A U = 1000 V 					
 8WH6000-0AM01	Versions <ul style="list-style-type: none"> Gray Blue 	8WH6000-0AM00 8WH6000-0AM01				
 8WH6000-0CM07	PE through-type terminals, terminal size 35 mm² <ul style="list-style-type: none"> Terminal width 16 mm Enclosed at both ends IEC 60947-7-2 <ul style="list-style-type: none"> Rigid 6 ... 35 mm² Flexible 6 ... 35 mm² AWG 10 ... 2 					

Version	SD	Article No. www.siemens.com/ product?Article No.	Price per PU	PU (UNIT, SET, M)	PS	PG
d						
Accessories						
		Covers, for terminal size 2.5 mm², width 2.2 mm				
		Versions <ul style="list-style-type: none"> • For two clamping points • For three clamping points • For four clamping points 				
		For general accessories for 8WH terminal blocks, see page 14/135 .				
		Covers, for terminal size 4 mm², width 2.2 mm				
		Versions <ul style="list-style-type: none"> • For two clamping points • For three clamping points • For four clamping points 				
8WH9003-1GA00						
		Covers, for through-type terminals, width 2.2 mm				
		Versions <ul style="list-style-type: none"> • For two clamping points 6 mm² • For two clamping points 10 mm² 				
8WH9004-3SA00						
8WH9005-1SA00						
		End covers, for terminal size 16 mm², width 2.2 mm				
		<ul style="list-style-type: none"> • For closing the open terminal side • Length 75.4 mm 				
		Versions <ul style="list-style-type: none"> • Gray 				
8WH9006-1SA00						
		Partitions, for terminal sizes 2.5 ... 4 mm², width 2.0 mm				
		<ul style="list-style-type: none"> • For visual and electrical separation of terminal groups • Gray 				
		Versions <ul style="list-style-type: none"> • For two clamping points • For three clamping points • For four clamping points 				
8WH9070-0AA00						
		Cover segments, for terminal size 2.5 mm²				
		For covering multi-wire terminals when mounting two-wire terminals side-by-side				
8WH9000-0GA00						

For general accessories for 8WH terminal blocks, [see page 14/135](#).

Terminal Blocks

8WH6 iPo Plug-In Terminals

8WH6 through-type terminals (high-current terminals) **NEW**

Overview

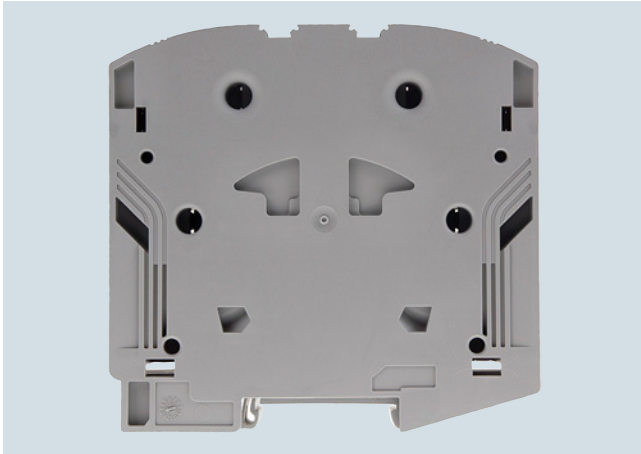

The 8WH6 through-type terminals for high-current applications are ideal for the direct wiring of conductors. They offer two options for wiring: With a standard screwdriver and a single lever movement, large conductors can be connected quickly and easily.

Alternatively, conductors can be inserted directly, even when the lever is closed.

There is a possibility of distributing the potentials using insertable jumpers. These are easily installed without the need for tools and also latch in the clamping space. Due to their special shape, they also remain recognizable after the conductor has been connected.





As an option, a latching tap-off terminal can be installed.

Technical specifications

	8WH6000-0AN00 8WH6000-0AN01 50 mm²	8WH6000-0CN07 50 mm²	8WH6000-0AQ00 8WH6000-0AQ01 95 mm²	8WH6000-0CQ07 95 mm²
Dimensions				
• Width / length	20 / 101	20 / 101	25 / 105.5	25 / 105.5
• Height (NS 35/7.5 / NS 35/15) in mm	-- / 105	-- / 105	-- / 108.7	-- / 108.7
Technical specifications acc. to IEC/DIN VDE				
• Max. load current in A / cross-section in mm ²	150 / 70	--	232 / 95	--
• Rated voltage in V	1000 AC / 1500 DC	--	1000 AC / 1500 DC	--
• Rated impulse withstand voltage in kV / pollution degree	8 / 3	8 / 3	8 / 3	8 / 3
• Overvoltage category / molded plastic group	III	III	III	III
Connection capacities				
• Flexible with end sleeve, with plastic sleeve in mm ²	10 ... 50	10 ... 50	25 ... 95	25 ... 95
• Flexible with end sleeve, without plastic sleeve in mm ²	10 ... 50	10 ... 50	25 ... 95	25 ... 95
• Rigid in mm ² / AWG	10 ... 70 / 8 ... 2/0	10 ... 70 / 8 ... 2/0	25 ... 95 / 4 ... 3/0	25 ... 95 / 4 ... 3/0
• Flexible in mm ² / AWG	10 ... 70 / 8 ... 2/0	10 ... 70 / 8 ... 2/0	25 ... 95 / 4 ... 3/0	25 ... 95 / 4 ... 3/0
Stripped length in mm	30	30	40	40
Plug gauge (IEC 60947-1)	A7	A7	--	--
Molded plastic type	PA	PA	PA	PA
• Flammability Class acc. to UL 94	V0	V0	V0	V0

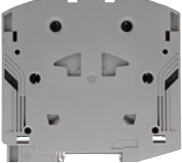
	8WH6000-0AS00, 8WH6000-0AS01, 150 mm²
Dimensions	
• Width / length	31/116.4
• Height (NS 35/7.5 / NS 35/15) in mm	-- / 116.5
Technical specifications acc. to IEC/DIN VDE	
• Max. load current in A / cross-section in mm ²	309/ 150
• Rated voltage in V	1000 AC / 1500 DC
• Rated impulse withstand voltage in kV / pollution degree	8 / 3
• Overvoltage category / molded plastic group	III
Connection capacities	
• Flexible with end sleeve, with plastic sleeve in mm ²	50 ... 95
• Flexible with end sleeve, without plastic sleeve in mm ²	50 ... 95
• Rigid in mm ² / AWG	50 ... 150 / 1/0 ... 300 kcmil
• Flexible in mm ² / AWG	50 ... 150 / 1/0 ... 300 kcmil
Stripped length in mm	40
Plug gauge (IEC 60947-1)	B14
Molded plastic type	PA
• Flammability Class acc. to UL 94	V0

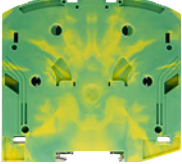
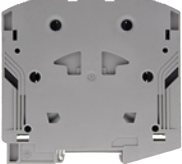

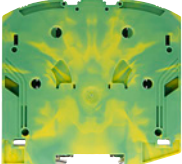



Selection and ordering data

Version	SD	Article No. www.siemens.com/ product?Article No.	Price per PU	PU (UNIT, SET, M)	PS	PG
d						
Terminal size 50 mm²						
 8WH6000-0AN00	 8WH6000-0AN01	Through-type terminals, terminal size 50 mm² <ul style="list-style-type: none"> Terminal width 20 mm Enclosed at both ends IEC 60947-7-1 <ul style="list-style-type: none"> Rigid 10 ... 70 mm² Flexible 10 ... 50 mm² AWG 8 ... 2/0 I = 150 A U = 1000 V AC, U = 1500 V DC 		8WH6000-0AN00 8WH6000-0AN01	1 10 units 1BT 1 10 units 1BT	
		Versions <ul style="list-style-type: none"> Gray Blue 				
 8WH6000-0CN07		PE through-type terminals, terminal size 50 mm² <ul style="list-style-type: none"> Terminal width 20 mm Enclosed at both ends IEC 60947-7-2 <ul style="list-style-type: none"> Rigid 7 ... 70 mm² Flexible 10 ... 50 mm² AWG 8 ... 2/0 		8WH6000-0CN07	1 10 units 1BT	
Terminal size 95 mm²						
 8WH6000-0AQ00	 8WH6000-0AQ01	Through-type terminals, terminal size 95 mm² <ul style="list-style-type: none"> Terminal width 20 mm Enclosed at both ends IEC 60947-7-1 <ul style="list-style-type: none"> Rigid 25 ... 95 mm² Flexible 25 ... 95 mm² AWG 4 ... 3/0 I = 232 A U = 1000 V AC, U = 1500 V DC 		8WH6000-0AQ00 8WH6000-0AQ01	1 10 units 1BT 1 10 units 1BT	
		Versions <ul style="list-style-type: none"> Gray Blue 				
 8WH6000-0CQ07		PE through-type terminals, terminal size 95 mm² <ul style="list-style-type: none"> Terminal width 20 mm Enclosed at both ends IEC 60947-7-1 <ul style="list-style-type: none"> Rigid 25 ... 95 mm² Flexible 25 ... 95 mm² AWG 4 ... 3/0 		8WH6000-0CQ07	1 10 units 1BT	

Terminal Blocks

8WH6 iPo Plug-In Terminals

8WH6 through-type terminals (high-current terminals) **NEW**

Version	SD	Article No. www.siemens.com/ product?Article.No.	Price per PU	PU (UNIT, SET, M)	PS	PG
Terminal size 150 mm²						
 8WH6000-0AS00  8WH6000-0AS01	Through-type terminals, terminal size 150 mm² <ul style="list-style-type: none"> Terminal width 31 mm Enclosed at both ends IEC 60947-7-1 <ul style="list-style-type: none"> Rigid 50 ... 150 mm² Flexible 50 ... 95 mm² AWG 1/0 ... 300 kcmil I = 309 A U = 1000 V AC, U = 1500 V DC 					
	Versions <ul style="list-style-type: none"> Gray Blue 		8WH6000-0AS00 8WH6000-0AS01		1 3 units 1BT 1 3 units 1BT	
Accessories						
 8WH9020-3AB00  8WH9020-3AG00	Jumpers					
	Versions <ul style="list-style-type: none"> 2-pole, 50 mm² 3-pole, 50 mm² 2-pole, 95 mm² 3-pole, 95 mm² 2-pole, 150 mm² 3-pole, 150 mm² 		8WH9020-3AB00 8WH9020-3AC00 8WH9020-3AD00 8WH9020-3AE00 8WH9020-3AF00 8WH9020-3AG00		1 5 units 1BT 1 5 units 1BT 1 5 units 1BT 1 5 units 1BT 1 5 units 1BT 1 5 units 1BT	
 8WH9120-0DA00	Tap-off terminals, for terminal sizes 50, 95 and 150 mm² 1-pole, 0,5 ... 10 mm ²		8WH9120-0DA00		1 10 units 1BT	
 8WH9010-0MB00	Insulating sleeves for test plugs, for terminal sizes 50, 95 and 150 mm² Color: Red		8WH9010-0MB02		1 10 units 1BT	
 8WH9010-0NB00	Test plugs for insulating sleeves, for terminal sizes 50, 95 and 150 mm² Color: metal		8WH9010-0NB00		1 10 units 1BT	

For general accessories for 8WH terminal blocks, see [page 14/135](#).

Overview

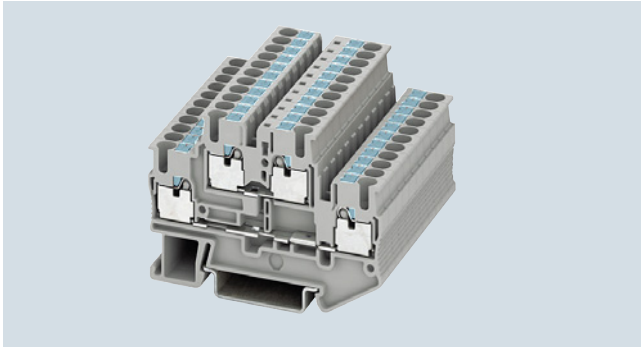

With the two voltage levels routed through two tiers, the 8WH6 two-tier terminals require 50% less space than equivalent single-tier terminals. To implement a wide range of wiring tasks, connecting combs can be fitted to both tiers of the two-tier terminal series. Facilities for inscription are provided at each clamping point.

Two-tier terminals with equipotential bonding for the upper and lower tiers are also available.

With the same contour as 8WH6 two-tier terminals, 8WH6 two-tier PE terminals round off the product range. Perfect mechanical and electrical contact with the support rail is provided by simply snapping the terminals onto the rail. 8WH6 two-tier PE terminals comply with all the requirements of IEC 60947-7-2. These include in particular:

- Low contact resistance
- Stainless clamping points
- Green-yellow enclosure
- Additional inscription options

An inscription label can be mounted flat at each clamping point by simply snapping it on.

Technical specifications

	8WH6020-0AF00 8WH6020-0AF01 2.5 mm ²	8WH6025-0AF00 2.5 mm ²	8WH6020-0CF07 2.5 mm ²	8WH6020-0AG00 8WH6020-0AG01 4 mm ²	8WH6025-0AG00 4 mm ²	8WH6020-0CG07 4 mm ²
Dimensions • Width / length / height (NS 35/7.5) in mm	5.2 / 68 / 47.5	5.2 / 78 / 55		6.2 / 83.5 / 47.5		
Max. electrical data • I_{max} in A • U_{max} in V • Max. Ø in mm ² • AWG	26 500 0.14 ... 4 26 ... 12	26 ¹⁾	-- --	32 500 0.2 ... 6 24 ... 10		-- --
Rating according to IEC 60947-7-1 • Rated voltage in V (IEC) • Rated current in A / cross-section in mm ² - IEC - UL/CSA • Rated cross-section in mm ² (IEC) • AWG cross-section range (IEC)	500 20 / 2.5 2.5 26 ... 12	20 ¹⁾ / 2.5	-- -- / --	500 / 600 30 / -- 4 24 ... 10 / 24 ... 10		-- -- / -- -- / --
Connection capacities • 1 conductor - Rigid in mm ² - Flexible in mm ² - End sleeve with/without plastic sleeve in mm ² • Conductor cross-section, direct plug-in - Rigid in mm ² - End sleeve with/without plastic sleeve in mm ²	0.14 ... 4 0.14 ... 2.5 0.14 ... 2.5 0.34 ... 4 0.34 ... 2.5			0.2 ... 6 0.2 ... 4 0.25 ... 4 0.5 ... 6 0.5 ... 4		
General data • Stripped length in mm • Molded plastic • Flammability Class acc. to UL 94	10 PA V0			12 PA V0		





¹⁾ The total current through all connected conductors must not exceed the maximum load current.

Terminal Blocks

8WH6 iPo Plug-In Terminals

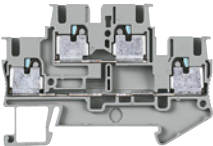
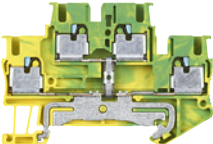
8WH6 two-tier terminals

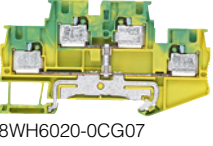
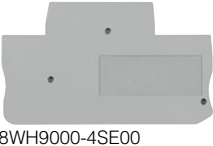
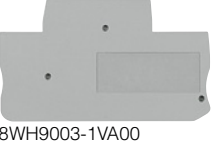
Selection and ordering data

Version	SD	Article No. www.siemens.com/ product?Article No.	Price per PU	PU (UNIT, SET, M)	PS	PG
d						
Terminal size 2.5 mm²						
		Two-tier terminals, terminal size 2.5 mm²				
8WH6020-0AF00		<ul style="list-style-type: none"> Terminal width 5.2 mm $I_{max} = 26$ A $U_{max} = 500$ V AWG 26 ... 12 Connection capacity, one conductor <ul style="list-style-type: none"> Rigid 0.14 ... 4 mm² Flexible 0.14 ... 2.5 mm² 				
		Versions				
		<ul style="list-style-type: none"> Without equipotential bonding <ul style="list-style-type: none"> Gray Blue With equipotential bonding 				
			8WH6020-0AF00	1	50 units	1BT
			8WH6020-0AF01	1	50 units	1BT
			8WH6025-0AF00	1	50 units	1BT
		PE two-tier terminals, terminal size 2.5 mm²				
8WH6020-0CF07		<ul style="list-style-type: none"> Terminal width 5.2 mm AWG 26 ... 12 Connection capacity, one conductor <ul style="list-style-type: none"> Rigid 0.14 ... 4 mm² Flexible 0.14 ... 2.5 mm² Green-yellow 				
		Note				
		Bridging the terminal is only possible in the top tier (in the center).				
			8WH6020-0CF07	1	50 units	1BT
Terminal size 4 mm²						
		Two-tier terminals, terminal size 4 mm²				
8WH6025-0AG00		<ul style="list-style-type: none"> Terminal width 6.2 mm $I_{max} = 32$ A $U_{max} = 500$ V AWG 24 ... 10 Connection capacity, one conductor <ul style="list-style-type: none"> Rigid 0.2 ... 6 mm² Flexible 0.2 ... 4 mm² 				
		Versions				
		<ul style="list-style-type: none"> Without equipotential bonding <ul style="list-style-type: none"> Gray Blue With equipotential bonding 				
			8WH6020-0AG00	1	50 units	1BT
			8WH6020-0AG01	1	50 units	1BT
			8WH6025-0AG00	1	50 units	1BT
		PE two-tier terminals, terminal size 4 mm²				
8WH6020-0CG07		<ul style="list-style-type: none"> Terminal width 6.2 mm AWG 24 ... 10 Connection capacity, one conductor <ul style="list-style-type: none"> Rigid 0.2 ... 6 mm² Flexible 0.2 ... 4 mm² Green-yellow 				
		Note				
		Bridging the terminal is only possible in the top tier (in the center).				
			8WH6020-0CG07	1	50 units	1BT
Accessories						
		Covers, for terminal sizes 1.5 ... 2.5 mm²				
8WH9000-4SE00		<ul style="list-style-type: none"> Width 2.2 mm Gray 				
			8WH9000-4SE00	100	50 units	1BT
		Covers, for terminal sizes 1.5 ... 4 mm²				
8WH9003-1VA00		<ul style="list-style-type: none"> For two clamping points Width 2.2 mm 				
			8WH9003-1VA00	100	50 units	1BT
		Compartment partitions, for terminal sizes 1.5 ... 4 mm²				
8WH9070-0BA00		<ul style="list-style-type: none"> For visual and electrical separation of terminal groups 2 mm thick Gray 				
			8WH9070-0BA00	100	50 units	1BT

For general accessories for 8WH terminal blocks, see [page 14/135](#).

Overview



The fuse terminals are characterized by their compact design and have the same contour as through-type terminals and function terminals. Double bridging is possible. Versions with LED display for signaling a fuse are also available.

Fuse terminals can be inscribed at their clamping points with flat labels.

Fuses must not be replaced under load.

Technical specifications

	8WH6000-1GG08	8WH6000-1KG38	8WH6000-1MG88
Dimensions			
• Width / length / height (NS 35/7.5) in mm	6.2 / 56 / 62.5		
Max. electrical data			
• I_{max} in A	6.3 ¹⁾		
• U_{max} in V	500		
• Max. Ø in mm ²	0.2 ... 6		
• AWG	24 ... 10		
Rating according to IEC 60947-7-1			
• Rated voltage in V (IEC / UL/CSA)	500 / 300		
• Rated current in A / cross-section in mm ²			
- IEC	6.3 / 1		
- UL/CSA	6.3 / --		
• Rated cross-section in mm ²	4		
• AWG cross-section range (IEC / UL/CSA)	24 ... 10 / 24 ... 10		
Connection capacities			
• 1 conductor			
- Rigid in mm ²	0.2 ... 6		
- Flexible in mm ²	0.2 ... 4		
- End sleeve with/without plastic sleeve in mm ²	0.25 ... 4		
• Conductor cross-section, direct plug-in			
- Rigid in mm ²	0.5 ... 6		
- End sleeve with/without plastic sleeve in mm ²	0.5 ... 4		
General data			
• Stripped length in mm	12		
• Molded plastic	PA		
• Flammability Class acc. to UL 94	V0		

¹⁾ The total current through all connected conductors must not exceed the maximum load current.

Selection and ordering data

Version	SD	Article No. www.siemens.com/ product?Article No.	Price per PU	PU (UNIT, SET, M)	PS	PG
	d					

Terminal size 4 mm²



8WH6000-1GG08

Fuse terminals, terminal size 4 mm², for G fuse links 5 x 20 mm

-
- Terminal width 6.2 mm
- $I_{max} = 6.3$ A
- $U_{max} = 500$ V
- AWG 24 ... 10
- Connection capacity, one conductor
 - Rigid 0.2 ... 4 mm²
 - Flexible 0.2 ... 4 mm²
- Black

Versions

- Without LED
- With LED 10 ... 30 V AC/DC
- With LED 110 ... 250 V AC/DC

8WH6000-1GG08	1 50 units	1BT
8WH6000-1KG38	1 50 units	1BT
8WH6000-1MG88	1 50 units	1BT

Accessories



8WA9003-1GA00

Covers, for terminal size 4 mm²

- For two clamping points
- Width 2.2 mm

8WH9003-1GA00

100 50 units 1BT

For general accessories for 8WH terminal blocks, see page 14/135.

Terminal Blocks

8WH6 iPo Plug-In Terminals

8WH6 isolating blade terminals

Overview

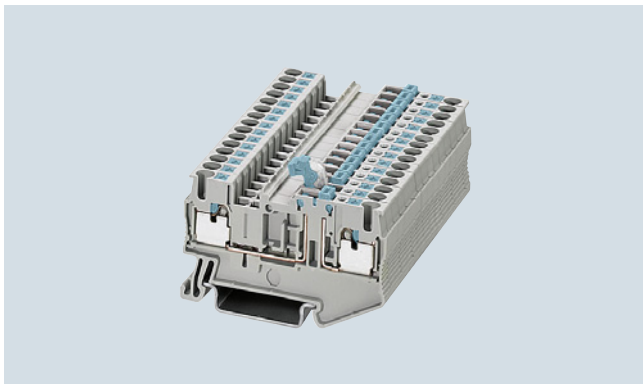

Through-type terminals with isolating blade capability are the most commonly used terminal types in measuring and control technology. Key features of the 8WH6 isolating blade terminals are the slim design of only 5.2 mm and their high current-carrying capacity. Convenient testing is made possible by the integral double function shaft located on one side of the isolating point and the integrated test contact located on the other. Standard connecting combs allow easy execution of all potential-distribution tasks. Three and four-wire terminals up to 2.5 mm² available for the multi-conductor connection.

A label can be snapped on to the middle of each terminal at the front. Further labels can also be mounted flat on the side of the terminals.

The isolating element must not be replaced under load.



Technical specifications

	8WH6000-6AF00	8WH6003-6AF00	8WH6004-6AF00
Dimensions			
• Width / length / height (NS 35/7.5) in mm	5.2 / 60.5 / 36.5	5.2 / 74 / 36.5	5.2 / 84 / 36.5
Max. electrical data			
• I_{max} in A	20	20 ¹⁾	
• U_{max} in V	400		
• Max. Ø in mm ²	0.14 ... 4		
• AWG	26 ... 12		
Rating according to IEC 60947-7-1			
• Rated voltage in V (IEC)	400		
• Rated current in A / cross-section in mm ² (IEC)	20 / 2.5	20 ¹⁾ / 2.5	
• Rated cross-section in mm ²	2.5		
• AWG cross-section range (IEC)	26 ... 12		
Connection capacities			
• 1 conductor			
- Rigid in mm ²	0.14 ... 4		
- Flexible in mm ²	0.14 ... 2.5		
- End sleeve with/without plastic sleeve in mm ²	0.14 ... 2.5		
• Conductor cross-section, direct plug-in			
- Rigid in mm ²	0.34 ... 4		
- End sleeve with/without plastic sleeve in mm ²	0.34 ... 2.5		
General data			
• Stripped length in mm	10		
• Molded plastic	PA		
• Flammability Class acc. to UL 94	V0		

¹⁾ The total current through all connected conductors must not exceed the maximum load current.

	8WH6000-6CG00
Dimensions	
• Width / length / height (NS 35/7.5) in mm	6.2 / 54 / 36.5
Max. electrical data	
• I_{max} in A	20
• U_{max} in V	400
• Max. Ø in mm ²	0.2 ... 6
• AWG	24 ... 10
Rating according to IEC 60947-7-1	
• Rated voltage in V (IEC / UL/CSA)	400 / 300
• Rated current in A / cross-section in mm ²	
- IEC	20 / 2.5
- UL/CSA	20 / --
• Rated cross-section in mm ²	4
• AWG cross-section range (IEC / UL/CSA)	24 ... 10 / 24 ... 10
Connection capacities	
• 1 conductor	
- Rigid in mm ²	0.2 ... 6
- Flexible in mm ²	0.2 ... 4
- End sleeve with/without plastic sleeve in mm ²	0.25 ... 4
• Conductor cross-section, direct plug-in	
- Rigid in mm ²	0.5 ... 6
- End sleeve with/without plastic sleeve in mm ²	0.5 ... 4
General data	
• Stripped length in mm	12
• Molded plastic	PA
• Flammability Class acc. to UL 94	V0

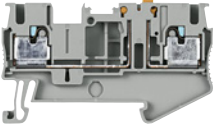
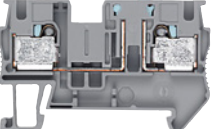
Selection and ordering data

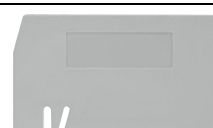
Version	SD	Article No. www.siemens.com/ product?Article No.	Price per PU	PU (UNIT, SET, M)	PS	PG
d						
Terminal size 2.5 mm²						
		Isolating blade terminals, terminal size 2.5 mm²				
8WH6000-6AF00		<ul style="list-style-type: none"> Terminal width 5.2 mm $I_{max} = 20$ A $U_{max} = 400$ V AWG 26 ... 12 Connection capacity, one conductor <ul style="list-style-type: none"> Rigid 0.14 ... 4 mm² Flexible 0.14 ... 2.5 mm² 				
		Versions				
		<ul style="list-style-type: none"> Two clamping points Three clamping points Four clamping points 				
			8WH6000-6AF00	1	50 units	1BT
			8WH6003-6AF00	1	50 units	1BT
			8WH6004-6AF00	1	50 units	1BT
Terminal size 4 mm²						
		Isolating blade terminals, terminal size 4 mm²				
8WH6000-6CG00		<ul style="list-style-type: none"> With 2 clamping points Terminal width 6.2 mm $I_{max} = 20$ A $U_{max} = 400$ V AWG 24 ... 10 Connection capacity, one conductor <ul style="list-style-type: none"> Rigid 0.2 ... 6 mm² Flexible 0.2 ... 4 mm² Connection capacity, two conductors <ul style="list-style-type: none"> Rigid 0.5 ... 6 mm² 				
			8WH6000-6CG00	1	50 units	1BT
Accessories						
		Covers, for terminal size 2.5 mm²				
8WH9000-3SC00		Width 2.2 mm <ul style="list-style-type: none"> For two clamping points For three clamping points For four clamping points 				
			8WH9000-3SC00	100	50 units	1BT
			8WH9000-3SD00	100	50 units	1BT
			8WH9000-5GA00	100	50 units	1BT
		Covers, for terminal size 4 mm²				
8WA9003-1GA00		<ul style="list-style-type: none"> For two clamping points Width 2.2 mm 				
			8WH9003-1GA00	100	50 units	1BT
		Compartment partitions, for terminal sizes 1.5 ... 4 mm²				
8WH9070-0AA00		<ul style="list-style-type: none"> For two clamping points For visual and electrical separation of terminal groups 2 mm thick Gray 				
			8WH9070-0AA00	100	50 units	1BT

For general accessories for 8WH terminal blocks, see page 14/135.

Terminal Blocks

8WH6 iPo Plug-In Terminals

8WH6 isolating terminals

Overview

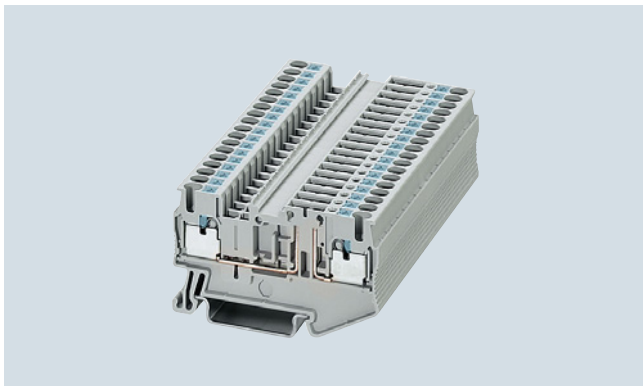

8WH6 isolating terminals in iPo connection technology are available for special wiring tasks. With the same contour as the isolating blade terminals, 8WH6 isolating terminals are fitted with a universal plug-in zone in the middle of the terminal. Numerous wiring tasks can be performed on a terminal width of 5.2 mm by integrating the isolated through-type connector, the isolating plug, the component connector or the fused plug.

A label can be snapped on to the middle of each terminal at the front. Further labels can also be mounted flat on the side of the terminals.

The isolating element must not be replaced under load.

Technical specifications



	8WH6000-6CF00	8WH6003-6CF00	8WH6004-6CF00
Dimensions			
• Width / length / height (NS 35/7.5) in mm	5.2 / 60.5 / 36.5	5.2 / 74 / 36.5	5.2 / 84 / 36.5
Max. electrical data			
• I_{max} in A	20	20 ¹⁾	
• U_{max} in V	400 ²⁾		
• Max. Ø in mm ²	0.14 ... 4		
• AWG	26 ... 12		
Rating according to IEC 60947-7-1			
• Rated voltage in V (IEC)	400 ²⁾		
• Rated current in A / cross-section in mm ² (IEC)	20 / 2.5	20 ¹⁾ / 2.5	
• Rated cross-section in mm ² (IEC)	2.5		
• AWG cross-section range (IEC)	26 ... 12		
Connection capacities			
• 1 conductor			
- Rigid in mm ²	0.14 ... 4		
- Flexible in mm ²	0.14 ... 2.5		
- End sleeve with/without plastic sleeve in mm ²	0.14 ... 2.5		
• Conductor cross-section, direct plug-in			
- Rigid in mm ²	0.34 ... 4		
- End sleeve with/without plastic sleeve in mm ²	0.34 ... 2.5		
General data			
• Stripped length in mm	10		
• Molded plastic	PA		
• Flammability Class acc. to UL 94	V0		

	8WH6000-6AG00
Dimensions	
• Width / length / height (NS 35/7.5) in mm	6.2 / 56 / 36.5
Max. electrical data	
• I_{max} in A	20
• U_{max} in V	400 ²⁾
• Max. Ø in mm ²	0.2 ... 6
• AWG	24 ... 10
Rating according to IEC 60947-7-1	
• Rated voltage in V (IEC / UL/CSA)	400 / 300
• Rated current in A / cross-section in mm ²	
- IEC	20 / 2.5
- UL/CSA	20 / --
• Rated cross-section in mm ²	4
• AWG cross-section range (IEC / UL/CSA)	24 ... 10 / 24 ... 10
Connection capacities	
• 1 conductor	
- Rigid in mm ²	0.2 ... 6
- Flexible in mm ²	0.25 ... 4
- End sleeve with/without plastic sleeve in mm ²	0.25 ... 4
• Conductor cross-section, direct plug-in	
- Rigid in mm ²	0.5 ... 6
- End sleeve with/without plastic sleeve in mm ²	0.5 ... 4
General data	
• Stripped length in mm	12
• Molded plastic	PA
• Flammability Class acc. to UL 94	V0

¹⁾ The total current through all connected conductors must not exceed the maximum load current.

²⁾ Current and voltage are determined by the fitted plug.

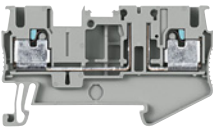
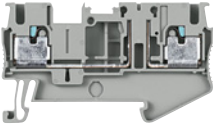
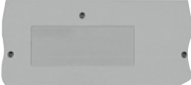
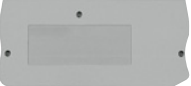
Selection and ordering data

Version	SD	Article No. www.siemens.com/ product?Article No.	Price per PU	PU (UNIT, SET, M)	PS	PG
d						
Terminal size 2.5 mm²						
		Isolating terminals, terminal size 2.5 mm²				
8WH6000-6CF00		<ul style="list-style-type: none"> Terminal width 5.2 mm $I_{max} = 20$ A $U_{max} = 400$ V AWG 26 ... 12 Connection capacity, one conductor <ul style="list-style-type: none"> Rigid 0.14 ... 4 mm² Flexible 0.14 ... 2.5 mm² 				
Versions						
		<ul style="list-style-type: none"> Two clamping points Three clamping points Four clamping points 				
			8WH6000-6CF00	1	50 units	1BT
			8WH6003-6CF00	1	50 units	1BT
			8WH6004-6CF00	1	50 units	1BT
Terminal size 4 mm²						
		Isolating terminal, terminal size 4 mm²				
8WH6000-6AG00		<ul style="list-style-type: none"> With two clamping points Terminal width 6.2 mm $I_{max} = 20$ A $U_{max} = 400$ V AWG 24 ... 10 Connection capacity, one conductor <ul style="list-style-type: none"> Rigid 0.2 ... 6 mm² Flexible 0.2 ... 4 mm² 				
			8WH6000-6AG00	1	50 units	1BT
Accessories						
		Covers, for terminal size 2.5 mm²				
8WH9000-3SC00		Width 2.2 mm <ul style="list-style-type: none"> For two clamping points For three clamping points For four clamping points 				
			8WH9000-3SC00	100	50 units	1BT
			8WH9000-3SD00	100	50 units	1BT
			8WH9000-5GA00	100	50 units	1BT
		Covers, for terminal size 4 mm²				
8WA9003-1GA00		<ul style="list-style-type: none"> For two clamping points Width 2.2 mm 				
			8WH9003-1GA00	100	50 units	1BT
		Compartment partitions, for terminal sizes 1.5 ... 4 mm²				
8WH9070-0AA00		<ul style="list-style-type: none"> For two clamping points For visual and electrical separation of terminal groups Width 2.2 mm Gray 				
			8WH9070-0AA00	100	50 units	1BT
		Compartment partitions, for terminal sizes 1.5 ... 4 mm²				
8WH9070-0GA00		<ul style="list-style-type: none"> For three clamping points For visual and electrical separation of terminal groups Width 2.2 mm Gray 				
			8WH9070-0GA00	100	50 units	1BT

For general accessories for 8WH terminal blocks, see page 14/135.

Terminal Blocks

8WH6 iPo Plug-In Terminals

8WH6 initiator/actor terminals **NEW**

Overview

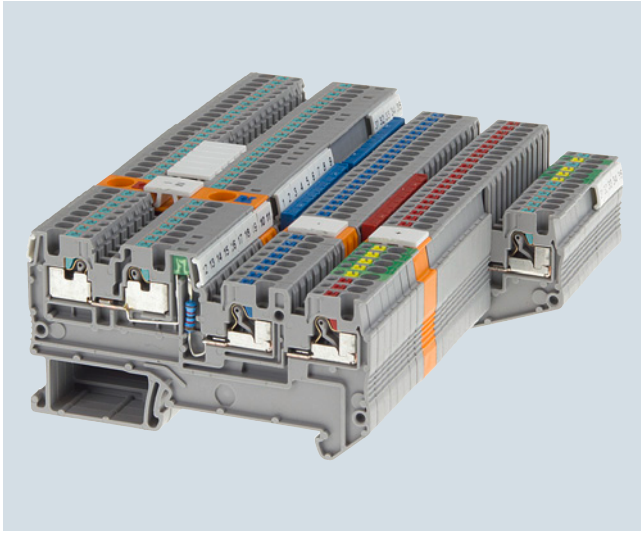

Terminal block with 3-wire initiator terminals and 4-wire actuator terminals

Thanks to their compact design, the initiator/actuator terminals are ideally suitable for the wiring of modern machine control systems. These terminals have identical contours and can be bridged throughout with the insertable jumper system, offering you maximum flexibility.

The feeder terminals are fitted with an additional negative outgoing feeder which can be used to supply isolated digital input/output modules. This enables the protective earth (PE) conductor to be bridged via the terminals.

Features

- Wide variety of products due to versions with PE function or illuminated display
- Optimum clarity of signal connections thanks to wide variety of marking options
- Modular expansion possible up to 40 poles, as feeder terminals have same contours

Reduced wiring outlay

The initiator/actuator terminals enable the number of cables used to be reduced:

- Sensors and actuators with 3 or 4 wires can be connected.
- The plus/minus potential can be connected with the jumpers.
- Apart from the standard terminals, versions with illuminated displays are available.

Technical specifications

Initiator terminals (3-wire connection, 8WH6003-....), actuator terminals (4-wire connection, 8WH6004-....)

	8WH600.-0DE00 1.5 mm ²	8WH600.-0FE00 1.5 mm ²	8WH600.-0HE00 1.5 mm ²	8WH600.-0DF04 Feeder terminal 2.5 mm ²
Dimensions				
• Width/length/cover width in mm	3.5 / 74.4 (90.8 ¹) / 2.2	3.5 / 74.4 (90.8 ¹) / 2.2	3.5 / 74.4 (90.8 ¹) / 2.2	7.0 / 74.4 (90.8 ¹) / 2.2
• Height (NS 35/7.5 / NS 35/15) in mm	41.5/ 49	41.5/ 49	41.5/ 49	41.5/ 49
Integrated LED (if available)				
• Color	--	Green	--	--
• Current consumption in mA	--	0.31 ... 0.95	--	--
• Rated voltage in V	--	24	--	--
• Voltage range in V	--	15 ... 50 AC/DC	--	--
Technical specifications acc. to IEC/DIN VDE				
• Max. load current in A / cross-section in mm ²	13.5 / 1.5	13.5 / 1.5	13.5 / 1.5	20 / 2.5
• Rated impulse withstand voltage in kV / pollution degree	4 / 3	4 / 3	4 / 3	4 / 3
• Overvoltage category / molded plastic group	III / I	III / I	III / I	III / I
Connection capacities in accordance with IEC 60947-7-1:				
• Flexible with end sleeve, with plastic sleeve in mm ²	0.14 ... 1.0	0.14 ... 1.0	0.14 ... 1.0	0.14 ... 1.0
• Flexible with end sleeve, without plastic sleeve in mm ²	0.14 ... 1.5	0.14 ... 1.5	0.14 ... 1.5	0.14 ... 1.5
• AWG	26 ... 14	26 ... 14	26 ... 14	24 ... 12
Stripped length in mm	8 ... 10	8 ... 10	8 ... 10	8 ... 10
Plug gauge (IEC 60947-1)	A1 / B1	A1 / B1	A1 / B1	A3
Molded plastic type	PA	PA	PA	PA
• Flammability Class acc. to UL 94	V0	V0	V0	V0
Approval data (UL/cUL and CSA), Category B				
• Rated voltage / rated current / conductor sizes				
- UL/cUL: in V/A / AWG	300/ 15 / 26 ... 14	300/ 15 / 26 ... 14	300/ 15 / 26 ... 14	300/ 16 / 24 ... 12
- CSA: in V/A / AWG	300/ 10 / 26 ... 14	300/ 10 / 26 ... 14	--/ -- / 26 ... 14	300/ 10 / 24 ... 10
Support rails/protective conductor busbars	see page 14/3, section "Support rails"			

¹) Length of actuator terminals (4-wire connection, 8WH6004-....).



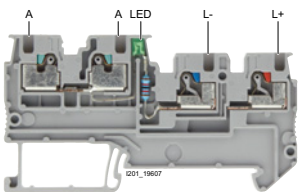
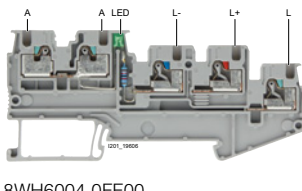
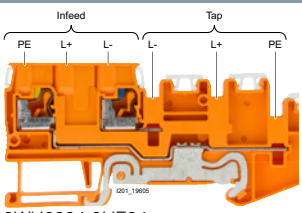



Selection and ordering data

Version	SD	Article No. www.siemens.com/ product?Article No.	Price per PU	PU (UNIT, SET, M)	PS	PG																				
<p>General details</p> <ul style="list-style-type: none"> • Thermoplastic insulating body • Front connection with spring-loaded terminal • L+ = red • L- = blue • A (output) = petrol • L = petrol • PE (ground) = green-yellow • Terminal open on one side 																										
<p>Terminal size 1.5 mm²</p> <div style="display: flex; align-items: flex-start;"> <div style="flex: 1;">  <p>8WH6003-0FE00</p> </div> <div style="flex: 2;"> <p>Initiator terminals, terminal size 1.5 mm²</p> <ul style="list-style-type: none"> • Light gray • Rated uninterrupted current 13.5 A • Rated insulation voltage 250 V • Mounting width 3.5 mm • For 250 V, pollution degree 3 • Current consumption with LED 0.31 ... 0.95 mA <table border="1"> <thead> <tr> <th>Circuit diagram</th> <th>Version</th> <th></th> <th></th> <th></th> </tr> </thead> <tbody> <tr> <td></td> <td>8WH6003-0DE00</td> <td>For 3-wire, L+, L-, A, without LED</td> <td>1</td> <td>50 units 1BT</td> </tr> <tr> <td></td> <td>8WH6003-0FE00</td> <td>For 3-wire, L+, L-, A, with green LED, 24 V (15 ... 30 V DC)</td> <td>1</td> <td>50 units 1BT</td> </tr> <tr> <td></td> <td>8WH6003-0HE00</td> <td>For 3-wire, L-, A, PE, without LED</td> <td>1</td> <td>50 units 1BT</td> </tr> </tbody> </table> </div> </div>							Circuit diagram	Version					8WH6003-0DE00	For 3-wire, L+, L-, A, without LED	1	50 units 1BT		8WH6003-0FE00	For 3-wire, L+, L-, A, with green LED, 24 V (15 ... 30 V DC)	1	50 units 1BT		8WH6003-0HE00	For 3-wire, L-, A, PE, without LED	1	50 units 1BT
Circuit diagram	Version																									
	8WH6003-0DE00	For 3-wire, L+, L-, A, without LED	1	50 units 1BT																						
	8WH6003-0FE00	For 3-wire, L+, L-, A, with green LED, 24 V (15 ... 30 V DC)	1	50 units 1BT																						
	8WH6003-0HE00	For 3-wire, L-, A, PE, without LED	1	50 units 1BT																						
<p>Terminal size 1.5 mm²</p> <div style="display: flex; align-items: flex-start;"> <div style="flex: 1;">  <p>8WH6004-0FE00</p> </div> <div style="flex: 2;"> <p>Actuator terminals, terminal size 1.5 mm²</p> <ul style="list-style-type: none"> • Light gray • Rated uninterrupted current 10 A • Rated insulation voltage 65 V • Mounting width 3.5 mm • For 250 V, pollution degree 2 • Current consumption with LED 0.31 ... 0.95 mA <table border="1"> <thead> <tr> <th>Circuit diagram</th> <th>Version</th> <th></th> <th></th> <th></th> </tr> </thead> <tbody> <tr> <td></td> <td>8WH6004-0DE00</td> <td>For 4-wire, L+, L-, L-, A</td> <td>1</td> <td>50 units 1BT</td> </tr> <tr> <td></td> <td>8WH6004-0FE00</td> <td>For 4-wire, L+, L-, L-, A, with green LED, 24 V (15 ... 30 V DC)</td> <td>1</td> <td>50 units 1BT</td> </tr> <tr> <td></td> <td>8WH6004-0HE00</td> <td>For 4-wire, L+, L-, PE, A, without LED</td> <td>1</td> <td>50 units 1BT</td> </tr> </tbody> </table> </div> </div>							Circuit diagram	Version					8WH6004-0DE00	For 4-wire, L+, L-, L-, A	1	50 units 1BT		8WH6004-0FE00	For 4-wire, L+, L-, L-, A, with green LED, 24 V (15 ... 30 V DC)	1	50 units 1BT		8WH6004-0HE00	For 4-wire, L+, L-, PE, A, without LED	1	50 units 1BT
Circuit diagram	Version																									
	8WH6004-0DE00	For 4-wire, L+, L-, L-, A	1	50 units 1BT																						
	8WH6004-0FE00	For 4-wire, L+, L-, L-, A, with green LED, 24 V (15 ... 30 V DC)	1	50 units 1BT																						
	8WH6004-0HE00	For 4-wire, L+, L-, PE, A, without LED	1	50 units 1BT																						
<p>Terminal size 2.5 mm²</p> <div style="display: flex; align-items: flex-start;"> <div style="flex: 1;">  <p>8WH6004-0HE04</p> </div> <div style="flex: 2;"> <p>Feeder terminals, terminal size 2.5 mm²</p> <ul style="list-style-type: none"> • Orange • Rated uninterrupted current 20 A • Rated insulation voltage 250 V • Mounting width 7 mm • For 250 V, pollution degree 3 • Open on both sides <table border="1"> <thead> <tr> <th>Circuit diagram</th> <th>Version</th> <th></th> <th></th> <th></th> </tr> </thead> <tbody> <tr> <td></td> <td>8WH6003-0DF04</td> <td>For 3-wire terminals, L+, L-, without PE</td> <td>1</td> <td>50 units 1BT</td> </tr> <tr> <td></td> <td>8WH6004-0HE04</td> <td>For 4-wire terminals, L+, L-, PE</td> <td>1</td> <td>50 units 1BT</td> </tr> </tbody> </table> </div> </div>							Circuit diagram	Version					8WH6003-0DF04	For 3-wire terminals, L+, L-, without PE	1	50 units 1BT		8WH6004-0HE04	For 4-wire terminals, L+, L-, PE	1	50 units 1BT					
Circuit diagram	Version																									
	8WH6003-0DF04	For 3-wire terminals, L+, L-, without PE	1	50 units 1BT																						
	8WH6004-0HE04	For 4-wire terminals, L+, L-, PE	1	50 units 1BT																						

Terminal Blocks

8WH6 iPo Plug-In Terminals

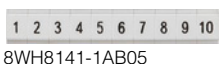

8WH6 initiator/actor terminals **NEW**

Version	SD	Article No. www.siemens.com/ product?Article.No.	Price per PU	PU (UNIT, SET, M)	PS	PG	
Accessories							
 8WH9001-4VE00	Covers, for terminal size 1.5 mm² Width 2.2 mm						
	<ul style="list-style-type: none"> For 3-wire initiator terminals For 4-wire actuator terminals 		8WH9001-2VD00 8WH9001-4VE00	100 100	50 units 50 units	1BT 1BT	
 8WH9020-6JC05	Connecting combs 3.5 mm						
	Versions	Max. load current I_{max}					
<ul style="list-style-type: none"> For terminal width 3.5 mm and terminal size 1.5 mm², red <ul style="list-style-type: none"> - 2-pole - 3-pole - 4-pole - 5-pole - 10-pole - 20-pole 		17.5 A	8WH9020-6JC02 8WH9020-6JD02 8WH9020-6JE02 8WH9020-6JF02 8WH9020-6JL02 8WH9020-6JS02	1 1 1 1 1 1	50 units 50 units 50 units 50 units 10 units 10 units	1BT 1BT 1BT 1BT 1BT 1BT	
 8WH9020-6JF01	<ul style="list-style-type: none"> For terminal width 3.5 mm and terminal size 1.5 mm², blue <ul style="list-style-type: none"> - 2-pole - 3-pole - 4-pole - 5-pole - 10-pole - 20-pole 		17.5 A	8WH9020-6JC01 8WH9020-6JD01 8WH9020-6JE01 8WH9020-6JF01 8WH9020-6JL01 8WH9020-6JS01	1 1 1 1 1 1	50 units 50 units 50 units 50 units 10 units 10 units	1BT 1BT 1BT 1BT 1BT 1BT
	 8WH9020-6JF00	<ul style="list-style-type: none"> For terminal width 3.5 mm and terminal size 1.5 mm², gray <ul style="list-style-type: none"> - 2-pole - 3-pole - 4-pole - 5-pole - 10-pole - 20-pole 		17.5 A	8WH9020-6JC00 8WH9020-6JD00 8WH9020-6JE00 8WH9020-6JF00 8WH9020-6JL00 8WH9020-6JS00	1 1 1 1 1 1	50 units 50 units 50 units 50 units 10 units 10 units
Labels, front, for terminal width 3.5 mm and terminal size 1.5 mm²							
 8WH8111-1AA05	Versions						
	<ul style="list-style-type: none"> Blank 			8WH8111-1AA05	100	100 units	1BT
 8WH8120-2XA05	<ul style="list-style-type: none"> Special inscription, vertical can only be ordered with the order code -ZY01 			8WH8120-2XA05 -Z and Y01	100	100 units	1BT
	 8WH8140-1AX05	<ul style="list-style-type: none"> Special inscription, horizontal can only be ordered with the order code -ZY01 			8WH8140-2XA05 -Z and Y01	100	100 units
Labels, flat, for terminal width 3.5 mm and terminal size 1.5 mm², printed vertically							
 8WH8141-1AB05	Versions						
	<ul style="list-style-type: none"> Consecutive numbering <ul style="list-style-type: none"> - 1 ... 10 (10x) - 11 ... 20 (10x) - 21 ... 30 (10x) - 31 ... 40 (10x) - 41 ... 50 (10x) Special inscription, can only be ordered with the order code -ZY01 			8WH8141-1A□□□ ▲▲▲ B05 B15 B25 B35 B45 8WH8141-1XA05 -Z and Y01	100 100	100 units 100 units	1BT 1BT

Terminal Blocks

8WH6 iPo Plug-In Terminals

NEW 8WH6 initiator/actor terminals

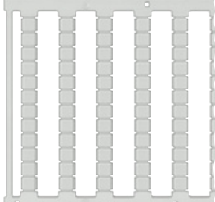

Version	SD	Article No. www.siemens.com/ product?Article.No.	Price per PU	PU (UNIT, SET, M)	PS	PG
 8WH8121-1AB05	d	Labels, flat, for terminal width 3.5 mm and terminal size 1.5 mm², printed horizontally Versions <ul style="list-style-type: none"> • Consecutive numbering <ul style="list-style-type: none"> - 1 ... 10 (10x) - 11 ... 20 (10x) - 21 ... 30 (10x) - 31 ... 40 (10x) - 41 ... 50 (10x) - 51 ... 60 (10x) • Special inscription, can only be ordered with the order code -ZY01 	8WH8121-1A□□□ ▲▲▲ B05 B15 B25 B35 B45 B55 8WH8121-1XA05 -Z and Y01	100	100 units	1BT
 8WH8111-1AA05		Labels, flat, for terminal width 3.5 mm and terminal size 1.5 mm², unprinted	8WH8111-1AA05	100	100 units	1BT
 8WH8113-0AA05		Labels, without inscription, for 8WH initiator/actuator terminals for labeling system Versions <ul style="list-style-type: none"> • Front <ul style="list-style-type: none"> - For 3.5 mm terminal width (WIN 486) • Flat <ul style="list-style-type: none"> - For 3.5 mm terminal width (WIN 416) <p>For more information, see see page 14/135 Section "Accessories for labeling system"</p>	8WH8112-0AA05 8WH8113-0AA05	100	1800 units	1BT
				100	3000 units	1BT

Terminal Blocks

8WH6 iPo Installation Terminals

Introduction

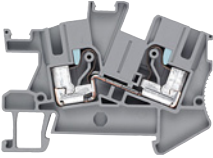
Overview

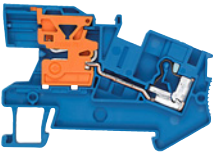
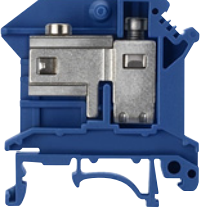
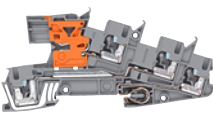
	Devices	Page	Function
	8WH through-type terminals	14/34	Connection of incoming and outgoing conductors up to 6 mm ²
	8WH through-type screw terminals	14/36	Connection of incoming and outgoing conductors up to 35 mm ² with screw terminals
	8WH N-conductor isolating terminals	14/38	Terminal blocks up to 6 mm ² and connection of an N-busbar 10 × 3 mm
	8WH N-conductor isolating screw terminals	14/40	Terminal blocks with screw connection up to 35 mm ² and connection of an N-busbar 10 × 3 mm
	8WH installation terminals	14/42	Terminal blocks for connection of an N-busbar 10 × 3 mm. These terminals offer up to three terminal functions in a single enclosure and are optimized for distribution board applications in installation technology.

Overview

Conductor cross-section	Terminal type ¹⁾	Connection type →		iPo technology Insta	Article No. (digits 8 ... 12)	
		Design →	Screw terminals Standard			
		No. of clamping points → 2				
		Article No. (digits 1 ... 7) →		8WH1001	8WH6001	
		Color				
2.5 mm ²	Through-type	Gray	--	✓	0AF00	
		Blue	--	✓	0AF01	
	N-conductor isolating	Blue	--	✓	0BF01	
	PE	Green-yellow	--	✓	0CF07	
	Insta	L	Gray	--	✓	4QF00
		L/L		--	✓	4DF00
		L/N		--	✓	4CF00
		PE/L/L		--	✓	4HF00
		PE/L/N		--	✓	4EF00
		PE/L/NT		--	✓	4FF00
PE/L/N isolating blade			--	✓	4GF00	
4 mm ²	Through-type	Gray	--	✓	0AG00	
		Blue	--	✓	0AG01	
	N-conductor isolating	Blue	--	✓	0BG01	
	PE	Green-yellow	--	✓	0CG07	
6 mm ²	Through-type	Gray	--	✓	0AH00	
		Blue	--	✓	0AH01	
	N-conductor isolating	Blue	--	✓	0BH01	
	PE	Green-yellow	--	✓	0CH07	
10 mm ²	N-conductor isolating	Blue	✓	--	0BJ01	
16 mm ²	Through-type	Gray	✓	--	0AK00	
		Blue	✓	--	0AK01	
	N-conductor isolating	Blue	✓	--	0BK01	
	PE	Green-yellow	✓	--	0CK07	
35 mm ²	Through-type	Gray	✓	--	0AM00	
		Blue	✓	--	0AM01	
	N-conductor isolating	Blue	✓	--	0BM01	
	PE	Green-yellow	✓	--	0CM07	

1) [Only the main terminal types are listed here.](#) You will find further versions on the following pages.

Terminal Blocks

8WH6 iPo Installation Terminals

8WH through-type terminals

Overview

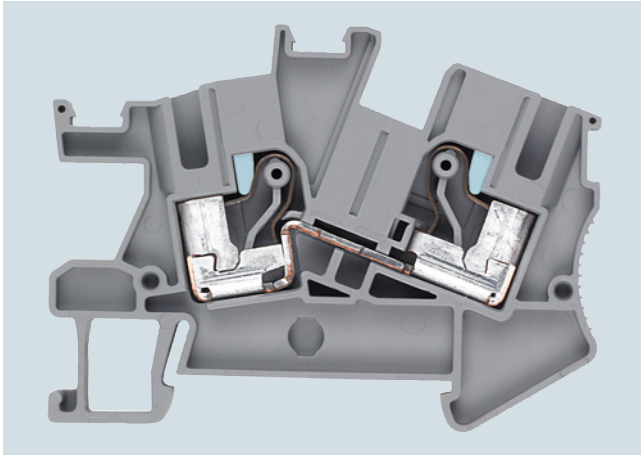

All types of conductors can be used with 8WH6 iPo technology. Rigid conductors and crimped flexible conductors are plugged directly into the terminal.

Flexible, untreated conductors can be connected using a screwdriver.

These terminals can be used interconnected with the N-busbar 10 × 3 mm.

An inscription label can be snapped on to the middle of each terminal at the front. Labels can also be mounted flat on the clamping points of the terminals.

Technical specifications

		8WH6001-0AF00 8WH6001-0AF01	8WH6001-0CF07	8WH6001-0AG00 8WH6001-0AG01	8WH6000-0CG07	8WH6001-0AH00 8WH6001-0AH01	8WH6001-0AH07
Cross-section	mm ²	2.5	2.5 (PE)	4	4 (PE)	6	6 (PE)
Dimensions							
• Width / length / width of cover	mm	5.2 / 59.5 / 2.2		6.2 / 66 / 2.2		8.2 / 66 / 2.2	
• Height (TS 35/7.5 / TS 35/15)	mm	43 / 50.5		46.3 / 53.8		50 / 57.5	
Rated current I_n / cross-section	A / mm ²	24 / 2.5	-- / 2.5	32 / 4	-- / 4	41 / 6	-- / 6
Max. load current I_{max} / cross-section	A / mm ²	24 / 4	-- / 4	32 / 6	-- / 6	50/10	-- / 10
Rated voltage U_n	V	800	--	800	--	800	--
Connection capacities							
• Rigid	mm ²	0.14 ... 4		0.2 ... 6		0.5 ... 10	
• Flexible with end sleeve	mm ²	0.25 ... 2.5		0.25 ... 4		0.5 ... 6	
Stripped length	mm	10		12		12	
Molded plastic type		PA					
Flammability Class acc. to UL 94		V0					
Support rails/protective conductor busbars		--	see page 14/3, section "Support rails"	--	see page 14/3, section "Support rails"	--	see page 14/3, section "Support rails"

Selection and ordering data

Version	SD	Article No. www.siemens.com/product?Article No.	Price per PU	PU (UNIT, SET, M)	PS	PG
	d					

Terminal size 2.5 mm²

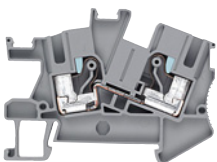

8WH6001-0AF00

Through-type terminals, terminal size 2.5 mm², acc. to IEC 60 947-7-1

- Terminal width 5.2 mm, terminal length 59.5 mm,
- Terminal height (NS 35/7.5) 43 mm
- Max. load current $I_{max} = 24$ A
- Rated voltage $U_n = 800$ V
- Rigid 0.14 ... 4 mm²
- Flexible with end sleeve 0.14 ... 2.5 mm²
- AWG 26 ... 12

Versions

- Gray
- Blue

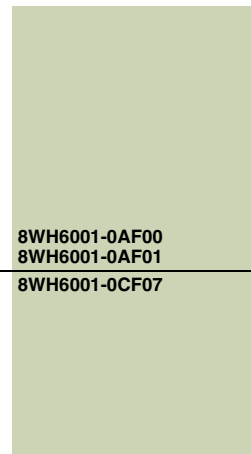

8WH6001-0AF00	1	50 units	1BT
8WH6001-0AF01	1	50 units	1BT



8WH6001-0CF07

PE through-type terminals, terminal size 2.5 mm², acc. to IEC 60 947-7-2







- Green-yellow
- Terminal width 5.2 mm, terminal length 59.5 mm,
- Terminal height 43 mm
- Cross-section max. 4 mm²
- Rigid 0.2 ... 4 mm²
- Flexible with end sleeve 0.2 ... 2.5 mm²
- AWG 24 ... 12

8WH6001-0CF07	1	50 units	1BT
----------------------	---	----------	-----

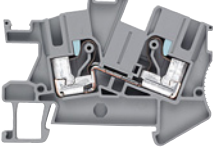
Terminal Blocks

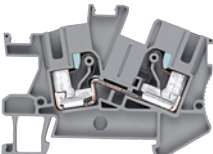
8WH6 iPo Installation Terminals

8WH through-type terminals

Version	SD	Article No. www.siemens.com/ product?Article.No.	Price per PU	PU (UNIT, SET, M)	PS	PG
d						
Terminal size 4 mm²						
		Through-type terminals, terminal size 4 mm², acc. to IEC 60947-7-1				
8WH6001-0AG00		<ul style="list-style-type: none"> Terminal width 6.2 mm Terminal length 66 mm Terminal height 46.3 mm Max. load current $I_{max} = 32$ A Rated voltage $U_n = 800$ V Rigid 0.2 ... 6 mm² Flexible with end sleeve 0.2 ... 4 mm² AWG 24 ... 10 				
Versions						
<ul style="list-style-type: none"> Gray Blue 						
			8WH6001-0AG00	1	50 units	1BT
			8WH6001-0AG01	1	50 units	1BT
		PE through-type terminals, terminal size 4 mm², acc. to IEC 60947-7-2				
8WH6001-0AG07		<ul style="list-style-type: none"> Green-yellow Terminal width 6.2 mm Terminal length 66 mm Terminal height 46.3 mm Rigid 0.2 ... 6 mm² Flexible with end sleeve 0.2 ... 4 mm² AWG 24 ... 10 				
			8WH6001-0CG07	1	50 units	1BT
Terminal size 6 mm²						
		Through-type terminals, terminal size 6 mm², acc. to IEC 60947-7-1				
8WH6001-0AH00		<ul style="list-style-type: none"> Terminal width 8.2 mm Terminal length 66 mm Terminal height 50 mm Max. load current $I_{max} = 41$ A Rated voltage $U_n = 800$ V Rigid 0.5 ... 10 mm² Flexible with end sleeve 0.5 ... 6 mm² AWG 20 ... 8 				
Versions						
<ul style="list-style-type: none"> Gray Blue 						
			8WH6001-0AH00	1	50 units	1BT
			8WH6001-0AH01	1	50 units	1BT
						
8WH6001-0AH01						
		PE through-type terminals, terminal size 6 mm², acc. to IEC 60947-7-2				
8WH6001-0AH07		<ul style="list-style-type: none"> Green-yellow Terminal width 8.2 mm Terminal length 66 mm Terminal height 50 mm Rigid 0.5 ... 10 mm² Flexible without end sleeve 0.5 ... 10 mm² Flexible with end sleeve 0.5 ... 6 mm² AWG 20 ... 8 				
			8WH6001-0CH07	1	50 units	1BT
Accessories						
		Support brackets				
		<ul style="list-style-type: none"> Made of blue molded plastic For holding the N-busbar 				
Versions						
<ul style="list-style-type: none"> For terminal size 2.5 ... 4 mm² For terminal size 6 mm² 						
8WH9143-0AF01			8WH9143-0AF01	1	50 units	1BT
			8WH9143-0AH01	1	50 units	1BT
		Covers				
		Gray				
Versions						
<ul style="list-style-type: none"> For terminal size 2.5 mm² For terminal size 4 mm² For terminal size 6 mm² 						
8WH9000-1WA00			8WH9000-1WA00	100	50 units	1BT
			8WH9003-7WA00	100	50 units	1BT
			8WH9004-1WA00	100	50 units	1BT

For general accessories for 8WH terminal blocks, see page 14/135.

Terminal Blocks

8WH6 iPo Installation Terminals

8WH through-type screw terminals

Overview

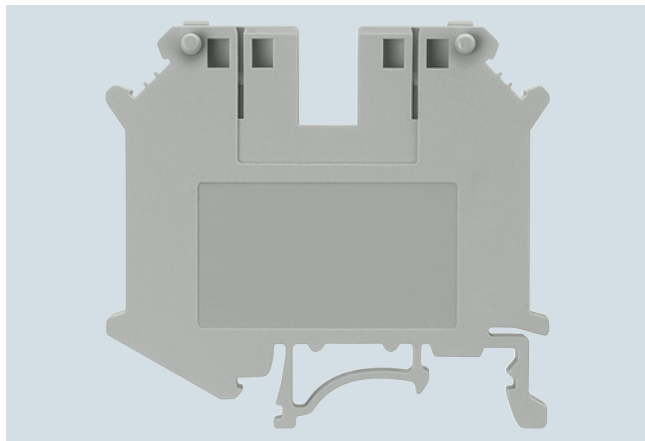

We offer a comprehensive range of installation terminals with iPo technology for use in building management systems. We also offer a range of compact, cost-effective terminal blocks with screw terminals for connecting larger cross-sections.

Terminal blocks mounted on N-busbars are most commonly used in building management systems. In order to enable the butt-mounting of different terminals, contact to the N-busbar is always on the same mounting level. This means that 8WH1001 screw terminals and 8WH6001 plug-in terminals can be combined as required and mounted on a single support rail.

Labels can be affixed at each clamping point by simply snapping them on at the front.

Technical specifications

		8WH1001-0AK00 8WH1001-0AK01	8WH1001-0CK07	8WH1001-0AM00 8WH1001-0AM01	8WH1001-0CM07
Cross-section	mm ²	16	16 (PE)	35	35 (PE)
Max. cross-section with comb (rigid / flexible)	mm ²	16 / 16	--	35 / 35	--
Dimensions					
• Width / length / width of cover	mm	12.2 / 42.5 / 1.8	12.2 / 42.5 / --	15.2 / 55 / --	15.2 / 55 / --
• Height (TS 35/7.5 / TS 35/15)	mm	47 / 54.5 / 52	47 / 54.5 / 52	51 / 58.5 / 56	51 / 58.5 / 56
Max. load current I_{max} / cross-section	A/mm ²	101 / 25	101 / 25	125 / 35	125 / 35
Rated impulse withstand voltage / pollution degree	kV	6 / 3	6 / 3	8 / 3	8 / 3
Overvoltage category / molded plastic group		III / I	III / I	III / I	III / I
Connection capacities					
• For one conductor					
- Rigid	mm ²	1.5 ... 16	1.5 ... 16	0.75 ... 35	0.75 ... 35
- Flexible with end sleeve	mm ²	1.5 ... 16	1.5 ... 16	0.75 ... 35	0.75 ... 35
• For two conductors of same cross-section					
- Rigid / flexible	mm ²	1.5 ... 6 / 1.5 ... 6	1.5 ... 6 / 1.5 ... 4	0.75 ... 10 / 0.75 ... 10	0.75 ... 10 / 0.75 ... 10
- Flexible with end sleeve	mm ²	1.5 ... 4	1.5 ... 6	0.75 ... 10	0.75 ... 10
Stripped length	mm	11	11	16	16
Plug gauge (IEC 60947-1)		B7	B7	B9	B9
Clamping point: screw thread / tightening torque	Nm	M4 / 1.5 ... 1.8	M4 / 1.5 ... 1.8	M6 / 3.2... 3.7	M5 / 3.2... 3.7
Fixing: screw thread / tightening torque	Nm	--	M4 / 1.5 ... 1.8	--	M5 / 2.5... 3
Molded plastic type		PA	PA	PA	PA
Flammability Class acc. to UL 94		V2	V2	V2	V2
Approval data (UL/cUL and CSA)					
• UL/cUL					
- Rated voltage / rated current / conductor sizes	V/A/AWG	600 / 85 / 22 ... 4	-- / -- / 22 ... 4	600 / 115 / 18 ... 2	-- / -- / 18 ... 2
• CSA					
- Rated voltage / rated current / conductor sizes	V/A/AWG	600 / 85 / 22 ... 4	-- / -- / 22 ... 4	600 / 130 / 18 ... 2	-- / -- / --

Selection and ordering data

Version	SD	Article No. www.siemens.com/ product?Article No.	Price per PU	PU (UNIT, SET, M)	PS	PG
	d					

Terminal size 16 mm²

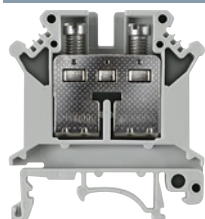

8WH1001-0AK00

Through-type screw terminals, terminal size 16 mm²

Width 12.2 mm

Versions

- Gray
- Blue







8WH1001-0AK00
8WH1001-0AK01

1 50 units 1BT
1 50 units 1BT

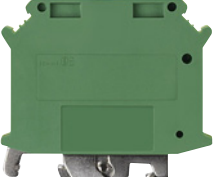
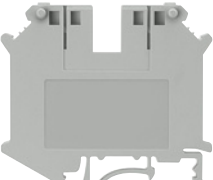
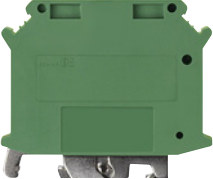
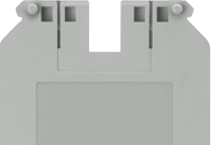
Terminal Blocks

8WH6 iPo Installation Terminals

8WH through-type screw terminals

Version	SD	Article No. www.siemens.com/ product?Article.No.	Price per PU	PU (UNIT, SET, M)	PS	PG
Terminal size 16 mm² (continued)						
		PE through-type screw terminals, terminal size 16 mm² <ul style="list-style-type: none">• Width 12.2 mm• Enclosed at both ends• Green-yellow		1	50 units	1BT
8WH1001-0CK07		8WH1001-0CK07				
Terminal size 35 mm²						
		Through-type screw terminals, terminal size 35 mm² <ul style="list-style-type: none">• Width 16 mm• Enclosed at both ends				
		Versions <ul style="list-style-type: none">• Gray• Blue				
8WH1001-0AM00		8WH1001-0AM00 8WH1001-0AM01		1 1	50 units 50 units	1BT 1BT
		PE through-type screw terminals, terminal size 35 mm² <ul style="list-style-type: none">• Width 16 mm• Enclosed at both ends• Green-yellow		1	50 units	1BT
8WH1001-0CM07		8WH1001-0CM07				
Accessories						
		Covers, for screw terminals <ul style="list-style-type: none">• 10/16 mm²• Width 2 mm• Gray		100	50 units	1BT
8WH9005-3PA00		8WH9005-3PA00				
		Connecting combs, 10-pole For through-type terminals, 16 mm ² , gray and blue		1	10 units	1BT
8WH9030-6AL00		8WH9030-6AL00				
		Connecting combs, 2-pole For through-type terminals, 35 mm ² , gray and blue		1	10 units	1BT
8WH9030-6BC00		8WH9030-6BC00				
		Connecting combs, 3-pole For through-type terminals, 35 mm ² , gray and blue		1	10 units	1BT
8WH9030-6BD00		8WH9030-6BD00				
		Compartment partitions For through-type terminals, 16 mm ² , gray and blue		100	50 units	1BT
8WH9070-6HA00		8WH9070-6HA00				
		Insulation plates For through-type terminals, 16 and 35 mm ² , gray and blue		100	50 units	1BT
8WH9070-6GA00		8WH9070-6GA00				

For general accessories for 8WH terminal blocks, see page 14/135.

Terminal Blocks

8WH6 iPo Installation Terminals

8WH N-conductor isolating terminals

Overview

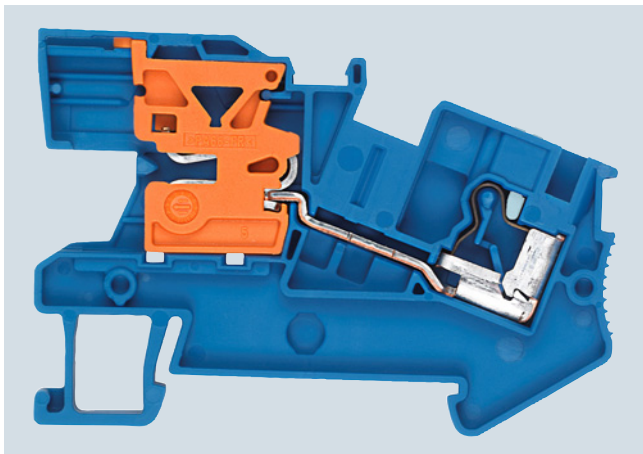

The N-conductor disconnect slides are located in the same position on all 8WH6001 terminals with an iPo plug-in connection.

A 10 × 3 mm busbar is used.

Notice: Only use Cu busbars.





Installation instructions: To ensure that the N-busbars are securely mounted, the support brackets must be placed at the beginning and end of each terminal strip (in the case of longer terminal strips: every 20 cm).

A label can be snapped on to the middle of the terminal at the front. Labels can also be mounted flat on the clamping points of the terminals (not with N-busbar connection).

Technical specifications

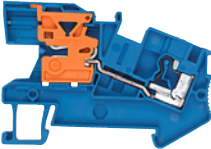
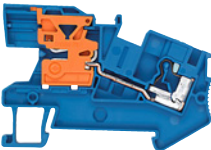
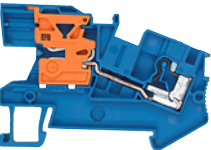
		8WH6001-0BF01	8WH6001-0BG01	8WH6001-0BH01
Cross-section	mm ²	2.5	4	6
Dimensions				
• Width / length / width of cover	mm	5.2 / 59 / 2.2	6.2 / 66 / 2.2	8.2 / 66 / 2.2
• Height (NS 35/7.5 / NS 35/15)	mm	46.3 / 53.8	46.3 / 53.8	50 / 57.5
Rated current I_n / cross-section	A / mm ²	24 / 2.5	32 / 4	41 / 6
Rated voltage U_n	V	250	250	400
Connection capacities				
• Rigid	mm ²	0.14 ... 4	0.2 ... 6	0.5 ... 10
• Flexible with end sleeve	mm ²	0.25 ... 2.5	0.25 ... 4	0.5 ... 6
Stripped length	mm	10	10	12
Molded plastic type		PA	PA	PA
• Flammability Class acc. to UL 94		V0	V0	V0

Selection and ordering data

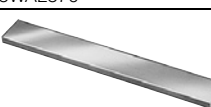
Version	SD	Article No. www.siemens.com/ product?Article No.	Price per PU	PU (UNIT, SET, M)	PS	PG
Terminal size 2.5 mm²						
		N-conductor isolating terminals, terminal size 2.5 mm², acc. to IEC 60947-7-1 <ul style="list-style-type: none"> • Two clamping points • Terminal width 5.2 mm • Terminal length 59 mm • Terminal height (NS 35/7.5) 46.3 mm • Rated current I_n / cross-section = 24 A / 2.5 mm² • Rated voltage $U_n = 250$ V • Rigid 0.14 ... 4 mm² • Flexible with end sleeve 0.14 ... 2.5 mm² • AWG 26 ... 12 				
8WH6001-0BF01		8WH6001-0BF01		1 50 units		1BT
Terminal size 4 mm²						
		N-conductor isolating terminals, terminal size 4 mm², acc. to IEC 60947-7-1 <ul style="list-style-type: none"> • Two clamping points • Terminal width 6.2 mm • Terminal length 66 mm • Terminal height (NS 35/7.5) 46.3 mm • Rated current I_n / cross-section = 32 A / 4 mm² • Rated voltage $U_n = 250$ V • Rigid 0.2 ... 6 mm² • Flexible with end sleeve 0.25 ... 4 mm² • AWG 24 ... 10 				
8WH6001-0BG01		8WH6001-0BG01		1 50 units		1BT
Terminal size 6 mm²						
		N-conductor isolating terminals, terminal size 6 mm², acc. to IEC 60947-7-1 <ul style="list-style-type: none"> • Two clamping points • Terminal width 8.2 mm • Terminal length 66.3 mm • Terminal height (NS 35/7.5) 50 mm • Max. load current $I_{max} = 41$ A • Rated current I_n / cross-section = 41 A / 6 mm² • Rated voltage $U_n = 400$ V • Rigid 0.5 ... 10 mm² • Flexible with end sleeve 0.5 ... 6 mm² • AWG 20 ... 8 				
8WH6001-0BH01		8WH6001-0BH01		1 50 units		1BT
Accessories						
		Support brackets <ul style="list-style-type: none"> • Made of blue molded plastic • For holding the N-busbar 				
	Versions					
		<ul style="list-style-type: none"> • For terminal size 2.5 ... 4 mm² • For terminal size 6 mm² 				
8WH9143-0AF01		8WH9143-0AF01		1 50 units		1BT
		8WH9143-0AH01		1 50 units		1BT
		Covers Gray				
	Versions					
		<ul style="list-style-type: none"> • For terminal size 2.5 mm² • For terminal size 4 mm² • For terminal size 6 mm² 				
8WH9000-1SA00		8WH9000-1SA00		100 50 units		1BT
		8WH9003-1SA00		100 50 units		1BT
		8WH9004-1SA00		100 50 units		1BT
		Feeder terminals, for N-busbars <ul style="list-style-type: none"> • 6 x 6 mm and 10 x 3 mm • Bare 				
	Versions					
		<ul style="list-style-type: none"> • Rated uninterrupted current 32 A, for connection of up to 4 mm² • Rated uninterrupted current 76 A, for connection of up to 25 mm² • Rated uninterrupted current 125 A, for connection of up to 35 mm² 				
8WA2867/8WA2868/ 8WA2870		8WA2867		1 50 units		1BT
		8WA2868		1 50 units		1BT
		8WA2870		1 50 units		1BT
		N-busbars, 10 x 3 mm <ul style="list-style-type: none"> • Tin-plated • 1000 mm long 				
8WA2842		8WA2842		1 1 unit		1BT

For general accessories for 8WH terminal blocks, see [page 14/135](#).

Terminal Blocks

8WH6 iPo Installation Terminals

8WH N-conductor isolating screw terminals

Overview

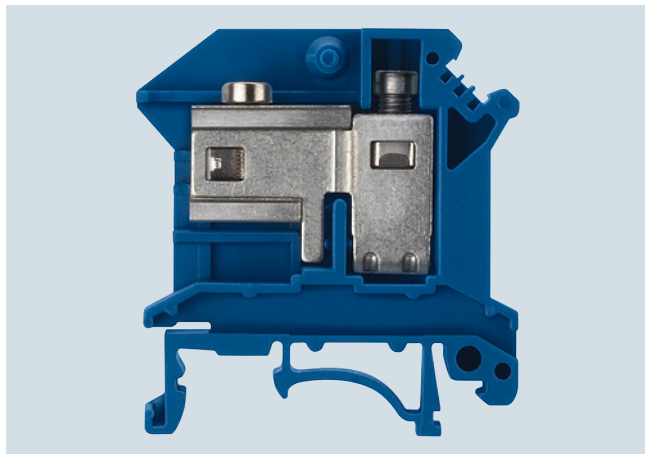

We offer a comprehensive range of installation terminals with iPo plug-in technology for use in building management systems. We also offer a range of compact, cost-effective terminal blocks with screw terminals for connecting larger cross-sections.

Terminal blocks mounted on N-busbars are most commonly used in building management systems. In order to enable the butt-mounting of different terminals, contact to the N-busbar is always on the same mounting level. This means that 8WH1001 screw terminals and 8WH6001 plug-in terminals can be combined as required and mounted on a single support rail.

The compact design of our N-conductor isolating terminals makes for a neat and clearly arranged terminal strip. The N-busbar can be connected over the terminal or over the disconnect slide of the N-conductor isolating terminal. The N-conductor isolating terminal also makes it easy to perform insulation measurements.

Labels can be affixed on the clamping points (screw) by simply snapping them on at the front.

Notice: Only use Cu busbars.

Technical specifications

		8WH1001-0BJ01	8WH1001-0BK01	8WH1001-0BM01
Cross-section	mm ²	10	16	35
Dimensions				
• Width / length / width of cover	mm	10.2 / 43.5 / 1.8	12.2 / 43.5 / 1.5	16 / 55 / --
• Height (TS 35/7.5 / TS 35/15)	mm	47 / 54.5 / 52	54 / 61.5 / 59	51 / 58.5 / 56
Max. load current I_{max} / cross-section	A/mm ²	63 / 16	90 / 25	110 / 35
Rated impulse withstand voltage / pollution degree	kV	6 / 3	6 / 3	6 / 3
Overvoltage category / molded plastic group		III / I	III / I	III / I
Connection capacities				
• For one conductor				
- Rigid	mm ²	1.5 ... 10	1.5 ... 16	0.75 ... 35
- Flexible with end sleeve	mm ²	1.5 ... 6	1.5 ... 16	0.75 ... 35
• For two conductors of same cross-section				
- Rigid / flexible	mm ²	1.5 ... 4 / 0.5 ... 4	1.5 ... 6 / 1.5 ... 4	0.75 ... 10 / 0.75 ... 10
- Flexible with end sleeve	mm ²	1.5 ... 2.5	1.5 ... 8	0.75 ... 10
Stripped length	mm	12	11	16
Plug gauge (IEC 60947-1)		B5	B6	B9
Clamping point: screw thread / tightening torque	Nm	M4 / 1.5 ... 1.8	M4 / 1.5 ... 1.8	M6 / 3.2 ... 3.7
Fixing: screw thread / tightening torque	Nm	M3 / 0.6 ... 0.8	M3 / 0.6 ... 0.8	M5 / 2.5 ... 3
Molded plastic type		PA	PA	PA
Flammability Class acc. to UL 94		V2	V2	V2

8WH N-conductor isolating screw terminals

Selection and ordering data

Version	SD	Article No. www.siemens.com/ product?Article No.	Price per PU	PU (UNIT, SET, M)	PS	PG
d						
Terminal size 10 mm²						
		N-conductor isolating screw terminals, terminal size 10 mm² <ul style="list-style-type: none"> • Width 10 mm • Blue • For 10 x 3 mm N-busbar 			1 50 units	1BT
8WH1001-0BJ01						
Terminal size 16 mm²						
		N-conductor isolating screw terminals, terminal size 16 mm² <ul style="list-style-type: none"> • Width 12 mm • Blue • For 10 x 3 mm N-busbar 			1 50 units	1BT
8WH1001-0BK01						
Terminal size 35 mm²						
		N-conductor isolating screw terminals, terminal size 35 mm² <ul style="list-style-type: none"> • Width 16 mm • Enclosed at both ends • Blue 			1 50 units	1BT
8WH1001-0BM01						
Accessories						
		Covers, for screw terminals <ul style="list-style-type: none"> • 10/16 mm² • Width 2 mm • Gray 			100 50 units	1BT
8WH9005-3PA00						
		Support brackets for N-conductor isolating screw terminals, terminal size 10 ... 35 mm² <ul style="list-style-type: none"> • For holding the N-busbar • To be placed every 20 cm • 2 mm wide 			1 50 units	1BT
8WH9141-0BA01						
		Terminals Blue Versions <ul style="list-style-type: none"> • Up to 16 mm², Width: 10.3 mm 			1 50 units	1BT
8WH9126-0BA01						
		N-busbars, 10 x 3 mm <ul style="list-style-type: none"> • Made of copper, tin-plated • 1000 mm long 			1 1 unit	1BT
8WA2842						

For general accessories for 8WH terminal blocks, see page 14/135.

Terminal Blocks

8WH6 iPo Installation Terminals

8WH installation terminals

Overview

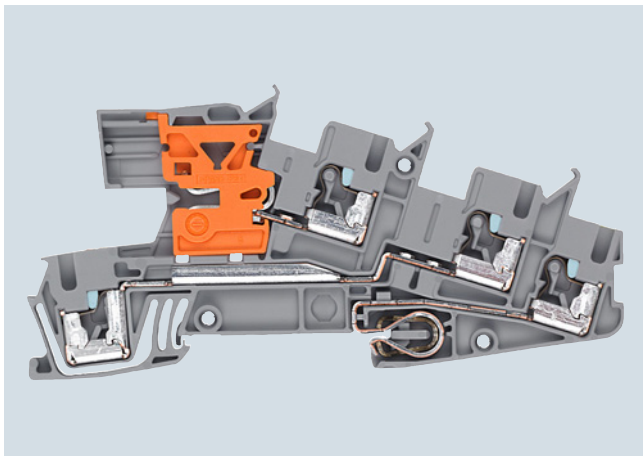

The three-tier plug-in terminals offer optimum operating characteristics for modern building installations. The plug-in connection allows tool-free wiring of the solid conductors.

These terminals can be used interconnected with the N-busbar 10 × 3 mm.

Notice: Only use Cu busbars.

Thanks to their compact design, the three-tier terminals can be installed in all types of building distribution boards. A load circuit can be quickly and easily wired, for example using a 5.2-mm-wide installation terminal with terminal size 2.5 mm² and PE/L/NT connections.

The double bridge shafts support a multitude of individual wiring tasks. This also means it is practical and convenient to make subsequent modifications to the installation.







Labels can be mounted flat on the clamping points of the terminals.

Technical specifications

Installation terminals, standard version		8WH6001-4QF00 8WH6001-4DF00 8WH6001-4CF00	8WH6001-0HF00 8WH6001-4EF00	8WH6001-4FF00
Installation terminals with isolating function			8WH6001-4GF00 8WH6001-4NF00 8WH6001-4PF00 8WH6001-4MF00	
Cross-section	mm ²	2.5		
Dimensions				
• Width / length / width of cover	mm	5.5 / 101 / 2.2		
• Height (TS 35/7.5 / TS 35/15)	mm	50.5 / 58		
Rated current I_n / cross-section	A / mm ²	24 / 4		
Max. load current I_{max} / cross-section	A / mm ²	30 ¹⁾ / 4		
Rated voltage U_n	V	400 (L-L) 250 (L-N or L-PE)		
Connection capacities				
• Rigid	mm ²	0.14 ... 4		
• Flexible with end sleeve	mm ²	0.14 ... 2.5		
Stripped length without insulation stop sleeve (no insulation stop sleeves should be used when using end sleeves)	mm	10		
Stripped length with insulation stop sleeve (no insulation stop sleeves should be used when using end sleeves)	mm	10		
Plug gauge (IEC 60947-1)		A3		
Molded plastic type		PA		
Flammability Class acc. to UL 94		V0		

¹⁾ 3-pole terminal block





Selection and ordering data

Version	SD	Article No. www.siemens.com/ product?Article No.	Price per PU	PU (UNIT, SET, M)	PS	PG
d						
Terminal size 2.5 mm²						
 8WH6001-4QF00  8WH6001-4DF00  8WH6001-4HF00  8WH6001-4FF00		Installation terminals, terminal size 2.5 mm², standard version for N-busbar <ul style="list-style-type: none"> • Gray • Terminal width 5.2 mm • Rigid 0.14 ... 4 mm² • Flexible with end sleeve 0.14 ... 2.5 mm² • AWG 26 ... 12 • Rated current / cross section $I_n = 24 \text{ A} / 4 \text{ mm}^2$ • Rated voltage $U_n = 400 \text{ V (L-L)}$ $U_n = 250 \text{ V (L-N or L-PE)}$ Versions <ul style="list-style-type: none"> • L • L/L • L/N • PE/L/L • PE/L/N • PE/L/NT 				
		8WH6001-4QF00 8WH6001-4DF00 8WH6001-4CF00 8WH6001-4HF00 8WH6001-4EF00 8WH6001-4FF00		1 50 units 1BT 1 50 units 1BT 1 50 units 1BT 1 50 units 1BT 1 50 units 1BT 1 50 units 1BT		
 8WH6001-4NF00		Installation terminals, terminal size 2.5 mm², with isolating blade <ul style="list-style-type: none"> • Gray • Terminal width 5.2 mm • Rigid 0.25 ... 4 mm² • Flexible with end sleeve 0.25 ... 2.5 mm² • AWG 22 ... 12 • Rated current / cross section $I_n = 24 \text{ A} / 4 \text{ mm}^2$ • Rated voltage $U_n = 400 \text{ V (L-L)}$ $U_n = 250 \text{ V (L-N or L-PE)}$ • The isolating element must not be replaced under load. Versions <ul style="list-style-type: none"> • PE/L/L (standard version, suitable for isolating terminals) • PE/L/N isolating blade • PE/L/L isolating blade 				
		8WH6001-4PF00 8WH6001-4GF00 8WH6001-4NF00		1 50 units 1BT 1 50 units 1BT 1 50 units 1BT		
 8WH6001-4PF00		Installation terminals, terminal size 2.5 mm², for isolating function <ul style="list-style-type: none"> • Gray • Terminal width 5.2 mm • Rigid 0.25 ... 4 mm² • Flexible with end sleeve 0.25 ... 2.5 mm² • AWG 22 ... 12 • Rated current / cross section $I_n = 24 \text{ A} / 4 \text{ mm}^2$ • Rated voltage $U_n = 400 \text{ V (L-L)}$ $U_n = 250 \text{ V, (L-PE)}$ • The isolating element must not be replaced under load. Versions <ul style="list-style-type: none"> • PE/L/L (standard version, suitable for isolating terminals) • PE/L/L isolation 				
		8WH6001-4PF00 8WH6001-4MF00		1 50 units 1BT 1 50 units 1BT		

Terminal Blocks



8WH6 iPo Installation Terminals

8WH installation terminals

Version	SD	Article No. www.siemens.com/ product?Article No.	Price per PU	PU (UNIT, SET, M)	PS	PG
Accessories						
 8WH9142-0AF01		Support brackets, for terminal size 2.5 mm² • For holding the N-busbar • To be placed every 20 cm • 2 mm wide		1	50 units	1BT
 8WH9000-3SA00		Covers, for terminal size 2.5 mm² gray		1	50 units	1BT
 8WH9000-6SA00		Covers, for terminal size 2.5 mm² and isolating terminal in the contour gray		1	50 units	1BT
 8WA2867/8WA2868/ 8WA2870		Feeder terminals, for N-busbars • 6 × 6 mm and 10 × 3 mm • Bare Versions • Rated uninterrupted current 32 A, for connection of up to 4 mm ² • Rated uninterrupted current 76 A, for connection of up to 25 mm ² • Rated uninterrupted current 125 A, for connection of up to 35 mm ²		1	50 units	1BT
 8WA2842		N-busbars, 10 x 3 mm • Made of copper, tin-plated • 1000 mm long		1	1 unit	1BT

For general accessories for 8WH terminal blocks, see [page 14/135](#).

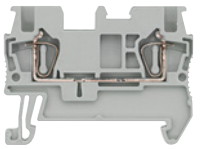
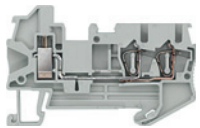
Overview

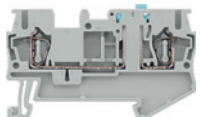
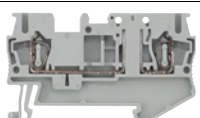
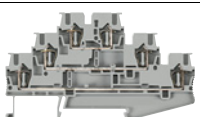
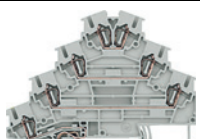
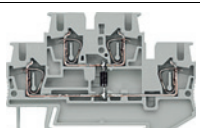
	Devices	Page	Application
8WH terminals			
	Through-type terminals	14/50	Connection of incoming and outgoing conductors up to 35 mm ²
	Hybrid through-type terminals	14/61	Terminals with a range of connection methods
	Fuse terminals	14/64	Terminals which can be used to protect control circuits, for example
	Isolating blade terminals	14/66	Isolation of the circuit, e.g. for test purposes
	Isolating terminals	14/68	Isolation of the circuit, e.g. for test purposes
	Two-tier terminals	14/70	Compact form of the terminal blocks in which two connection wires can be installed
	Three-tier terminals	14/76	Compact terminal blocks up to 2.5 mm ² , in which three connection wires can be installed
	Four-tier motor terminals	14/78	Compact terminal blocks up to 4 mm ² , in which three connection wires plus PE can be installed
	Diode terminals	14/80	Terminal blocks with integrated diodes
	Two-tier diode terminals	14/82	Terminal blocks with integrated diodes

Terminal Blocks

8WH2 Spring-Loaded Terminals

General data

Overview

Conductor cross-section	Connection type →		Standard spring-loaded connection					Article No. (digits 8 ... 12)	
	Terminal type ¹⁾	Color	Design →	Standard			Two-tier		
			No. of clamping points →	2	3	4	4		6
			Article No. (digits 1 ... 7) →	8WH2000	8WH2003	8WH2004	8WH2020		8WH2023
1.5 mm ²	Through-type	Gray	✓	✓	✓	✓	--	0AE00	
		Blue	✓	✓	✓	✓	--	0AE01	
	PE	Green-yellow	✓	✓	✓	✓	--	0CE07	
2.5 mm ²	Through-type	Gray	✓	✓	✓	✓	✓	0AF00	
		Blue	✓	✓	✓	✓	✓	0AF01	
	Isolating	Gray	✓	✓	✓	--	--	6AF00	
	Isolating blade	Gray	✓	✓	✓	--	--	0CF00	
	PE	Green-yellow	✓	✓	✓	✓	✓	0CF07	
4 mm ²	Through-type	Gray	✓	✓	✓	✓	--	0AG00	
		Blue	✓	✓	✓	✓	--	0AG01	
	Isolating	Gray	✓	--	--	--	--	6AG00	
	Isolating blade	Gray	✓	--	--	--	--	6CG00	
	PE	Green-yellow	✓	✓	✓	✓	--	0CG07	
6 mm ²	Through-type	Gray	✓	✓	--	--	--	0AH00	
		Blue	✓	✓	--	--	--	0AH01	
	PE	Green-yellow	✓	✓	--	--	--	0CH07	
10 mm ²	Through-type	Gray	✓	--	--	--	--	0AJ00	
		Blue	✓	--	--	--	--	0AJ01	
	PE	Green-yellow	✓	--	--	--	--	0CJ07	
16 mm ²	Through-type	Gray	✓	--	--	--	--	0AK00	
		Blue	✓	--	--	--	--	0AK01	
	PE	Green-yellow	✓	--	--	--	--	0CK07	
35 mm ²	Through-type	Gray	✓	--	--	--	--	0AM00	
		Blue	✓	--	--	--	--	0AM01	
	PE	Green-yellow	✓	--	--	--	--	0CM07	

1) Only the main terminal types are listed here. You will find further versions on the following pages.

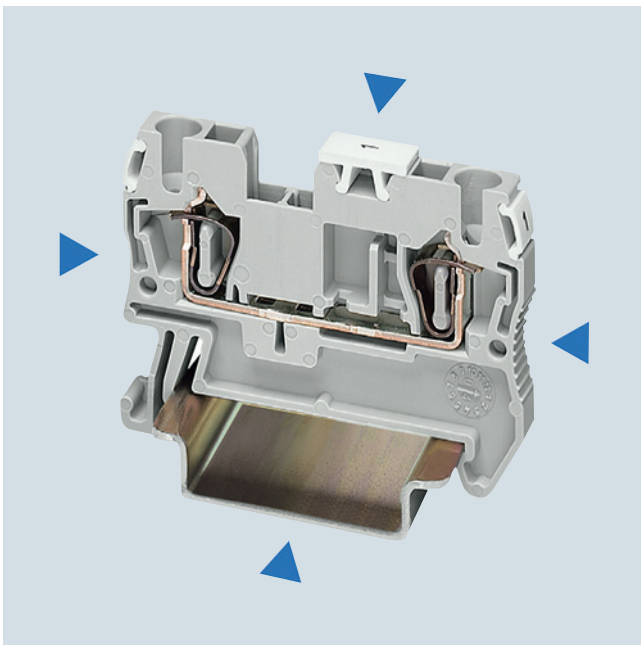

The space-saving design and conductor routing from above make spring-loaded terminals ideal for controlgear installations with minimum available space. The terminals are open at one end and can be closed using the appropriate covers.

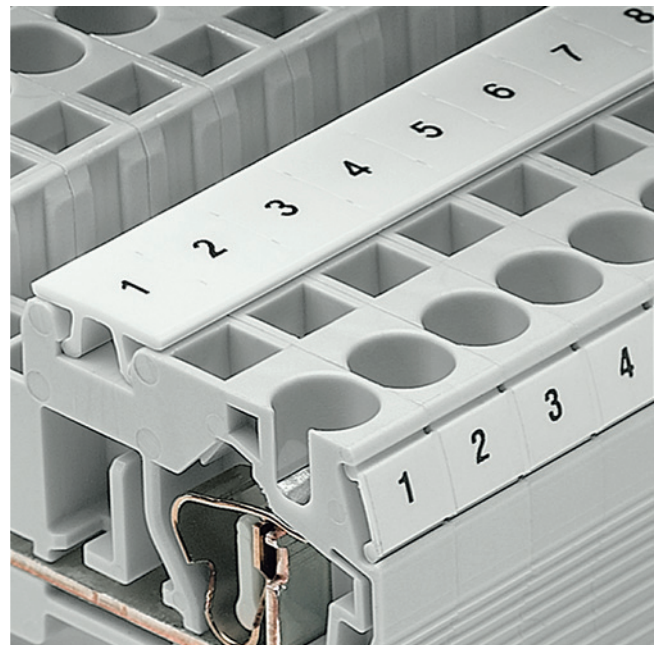

The large and unambiguous marking in the center of the terminal is essential for ensuring reliable installation in minimum time. Each clamping point can also be separately labeled.

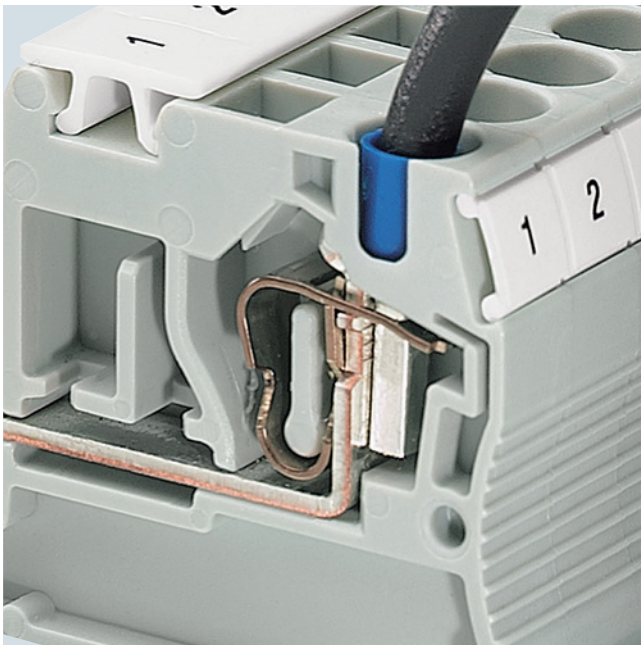

Spring-loaded terminals provide a large connection compartment for fast wiring of flexible and rigid conductors, including conductors with nominal cross-section and a fitted end sleeve.

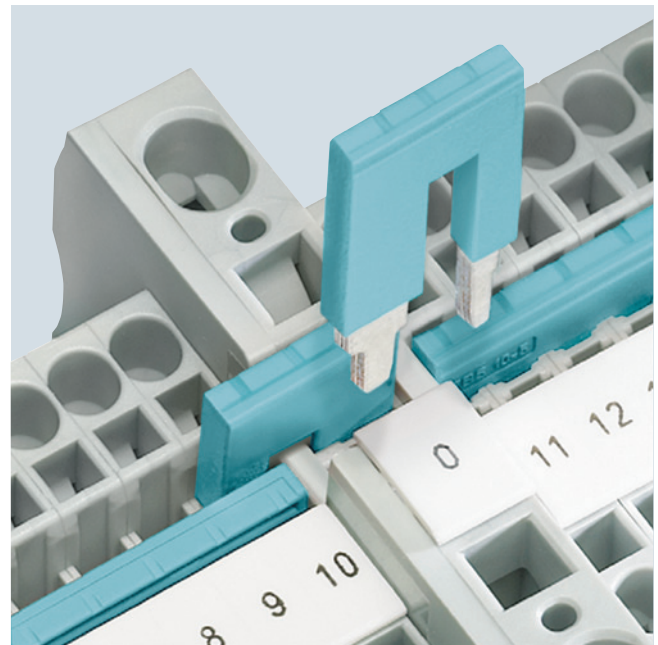

Reducing combs enable easy connection of terminals with various nominal cross-sections. For example, they can be used for the fast creation of infeed blocks, e.g. by connecting a 10 mm² spring-loaded terminal with a 2.5 or 4 mm² spring-loaded terminal.

Terminal Blocks

8WH2 Spring-Loaded Terminals

General data

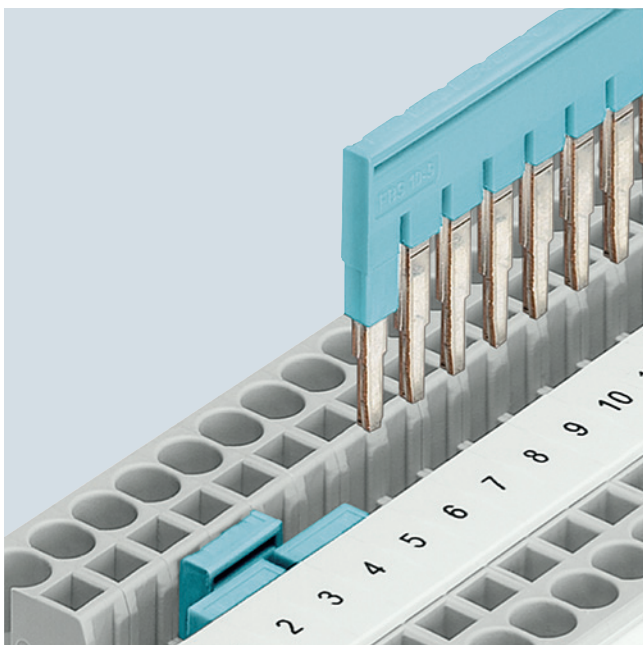

The 2 to 50-pole connecting combs also considerably reduce the time needed for assembly and wiring as they enable up to 50 terminals to be connected in a single step.

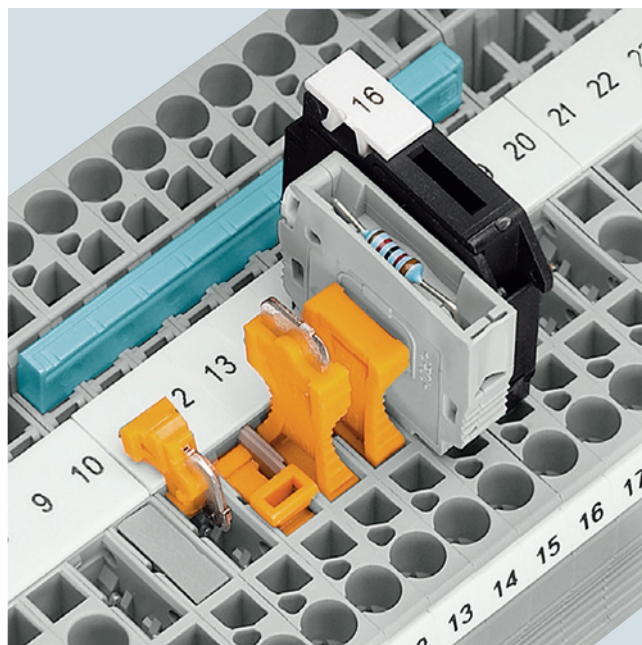

The universal plug-in zones of the isolating terminal can accommodate the isolated through-type connectors, isolating plugs, component connectors and fused connectors.

The isolating element (isolating plug) must not be replaced under load.

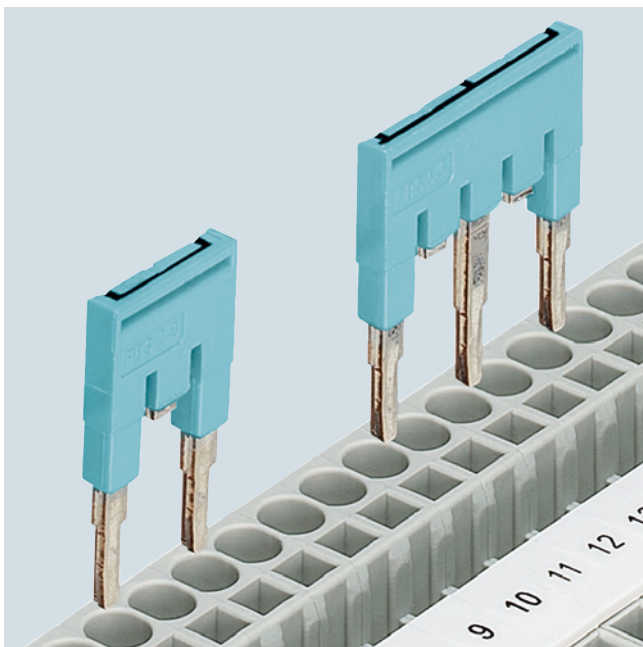

Contact tabs can be removed from the standard comb in order to skip individual terminals. This means that two potentials can run in parallel on a single terminal strip. The contact points can additionally be marked.

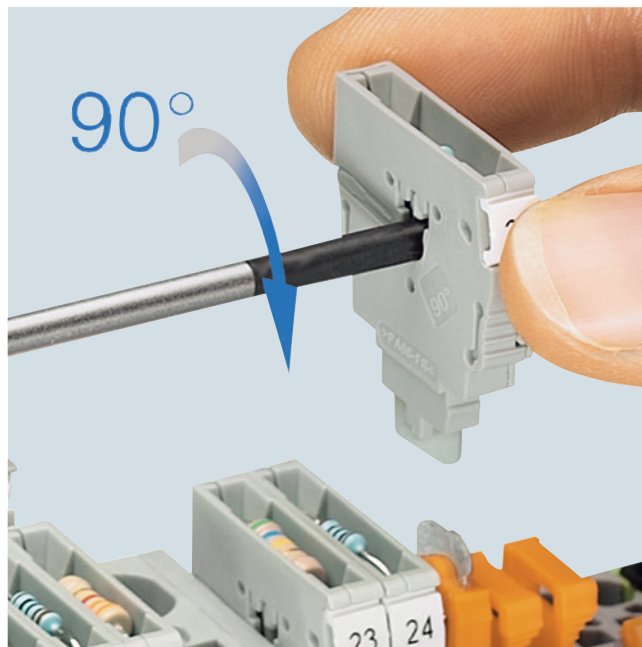

The component connector enables the convenient equipping with electronic components. One turn of the screwdriver opens the contact points and the component is easily inserted.

The isolating element must not be replaced under load.

Terminal Blocks

8WH2 Spring-Loaded Terminals

General data

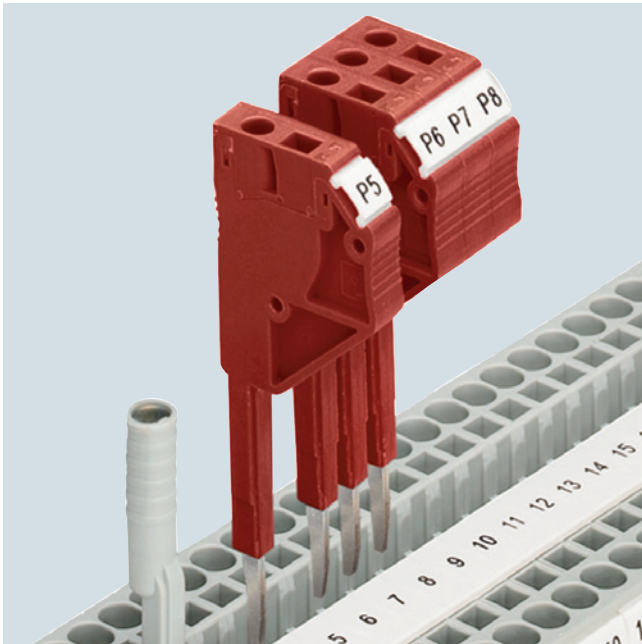

A comprehensive range of test accessories is also available for the spring-loaded terminal series. The test adapters for Ø 4 mm test plugs and modular test plugs enable all measuring and testing jobs to be performed in minimum time.



Cover segments are used to cover the projecting terminal segments of three and four-wire terminals when mounting two-wire terminals side-by-side. This ensures touch protection.

Note: The accessories for 8WH can only be used for 8WH terminals.

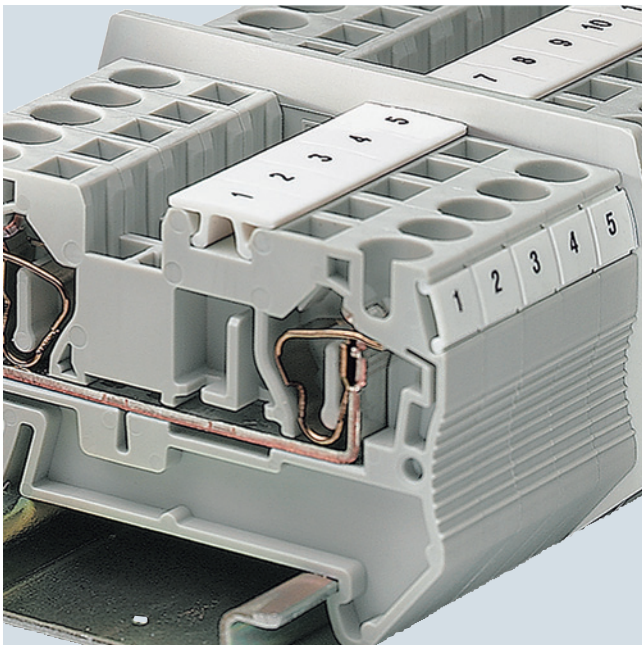

The compartment partitions project beyond the contours of the terminals and separate the groups both visually and electrically.

Terminal Blocks

8WH2 Spring-Loaded Terminals

8WH through-type terminals

Overview

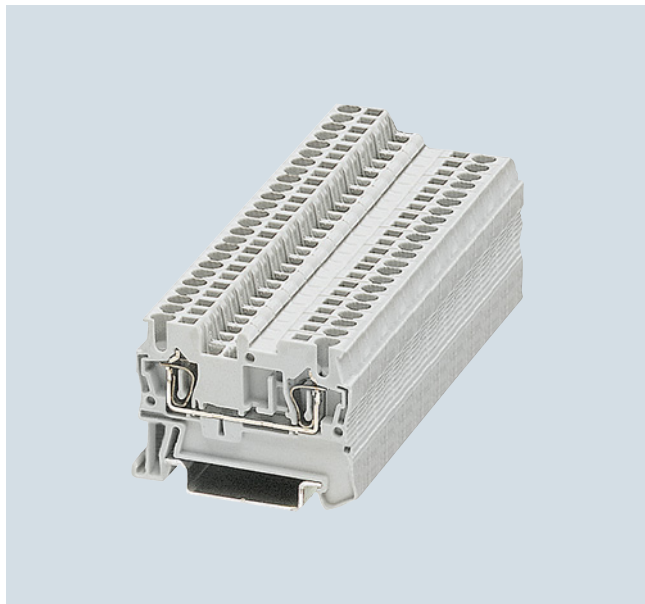

With two clamping points

The through-type terminals have an impressive space-saving design and offer optimized handling. With its front connection arrangement this series provides additional space between the cable ducts for wiring.

The double bridge shaft enables individual chain bridging with connecting combs. Accessories are available for testing and labeling.

With three clamping points

Terminals with three clamping points are a space-saving alternative to the standard through-type terminals for branching the potential.

It is often necessary for three conductors to be routed to a single terminal. This three-clamping-point version enables this without the need for additional terminals and jumpers.

With four clamping points

The double connection of the through-type terminals with four clamping points enables four conductors to be connected to a single potential. These versions with four clamping points are therefore suitable for use as compact potential distributors.

A label can be snapped on to the middle of each terminal at the front. Further labels can also be mounted flat on the side of the terminals.

PE/ground conductor function

The PE through-type terminals are available with the same contour as the through-type terminals. Simply snap the terminals onto the support rail to achieve full mechanical and electrical contact with the support rail.

The PE through-type terminals meet all the requirements of IEC 60947-7-2:

- Low contact resistance
- Stainless clamping points
- Green-yellow enclosure
- Additional inscription options

Technical specifications

	8WH2000-0AE0.	8WH2000-0CE07	8WH2003-0AE00 8WH2003-0AE01	8WH2003-0CE07	8WH2004-0AE00 8WH2004-0AE01
Dimensions					
• Width/length/cover width in mm	4.2 / 48.5 / 2.2		4.2 / 60.5 / 2.2		4.2 / 72 / 2.2
• Height (NS 35/7.5 / NS 35/15) in mm	36.8 / 44		36.5 / 44		
Technical specifications acc. to IEC/DIN VDE					
• Max. load current in A / cross-section in mm ²	17.5 / 1.5	--	17.5 / 1.5	--	17.5 / 1.5
• Rated impulse withstand voltage in kV / pollution degree	6 / 3				
• Overvoltage category / molded plastic group	III / I				
Connection capacities					
• Flexible with end sleeve, with plastic sleeve in mm ²	0.25 ... 1.5				
• Flexible with end sleeve, without plastic sleeve in mm ²	0.25 ... 1.5				
• Flexible with two-wire connection end sleeve, with plastic sleeve in mm ²	0.5				
Stripped length in mm	10				
Plug gauge (IEC 60947-1)	A1				
Molded plastic type	PA				
• Flammability Class acc. to UL 94	V0				
Approval data (UL/cUL and CSA)					
• Rated voltage / rated current / conductor sizes					
- UL/cUL: in V/A / AWG	300 / 15 / 26 ... 14	-- / -- / 26 ... 14	300 / 15 / 26 ... 14	-- / -- / 26 ... 14	300 / 15 / 26 ... 14
- CSA: in V/A / AWG	300 / 15 / 26 ... 14	-- / -- / 26 ... 14	300 / 15 / 26 ... 14	--	300 / 15 / 26 ... 14
Support rails/protective conductor busbars	--	see page 14/3, section "Support rails"	--	see page 14/3, section "Support rails"	--

Terminal Blocks

8WH2 Spring-Loaded Terminals

8WH through-type terminals

	8WH2004-0CE07	8WH2000-0AF0.	8WH2000-0CF07	8WH2003-0AF00 8WH2003-0AF01	8WH2003-0CF07
Dimensions					
• Width/length/cover width in mm	4.2 / 72 / 2.2	5.2 / 48.5 / 2.2		5.2 / 60.5 / 2.2	
• Height (NS 35/7.5 / NS 35/15) in mm	36.5 / 44	36.8 / 44		36.5 / 44	
Technical specifications acc. to IEC/DIN VDE					
• Max. load current in A / cross-section in mm ²	--	31 / 4	--	28 / 4	--
• Rated impulse withstand voltage in kV / pollution degree	6 / 3	8 / 3			
• Overvoltage category / molded plastic group	III / I				
Connection capacities					
• Flexible with end sleeve, with plastic sleeve in mm ²	0.25 ... 1.5	0.25 ... 2.5			
• Flexible with end sleeve, without plastic sleeve in mm ²	0.25 ... 1.5	0.25 ... 2.5			
• Flexible with two-wire connection end sleeve, with plastic sleeve in mm ²	0.5				
Stripped length in mm	10				
Plug gauge (IEC 60947-1)	A1	A3			
Molded plastic type	PA				
• Flammability Class acc. to UL 94	V0				
Approval data (UL/cUL and CSA)					
• Rated voltage / rated current / conductor sizes					
- UL/cUL: in V/A / AWG	-- / -- / 26 ... 14	300 / 20 / 26 ... 12	-- / -- / 26 ... 12	600 / 20 / 26 ... 12	-- / -- / 26 ... 12
- CSA: in V/A / AWG	-- / -- / 26 ... 14	--			
Support rails/protective conductor busbars	see page 14/3, section "Support rails"	--	see page 14/3, section "Support rails"	--	see page 14/3, section "Support rails"
	8WH2004-0AF00 8WH2004-0AF01	8WH2004-0CF07	8WH2000-0AG0.	8WH2003-0AG00 8WH2003-0AG01	8WH2004-0AG00 8WH2004-0AG01
Dimensions					
• Width/length/cover width in mm	5.2 / 72 / 2.2		6.2 / 56 / 2.2	6.2 / 71.5 / 2.2	6.2 / 87 / 2.2
• Height (NS 35/7.5 / NS 35/15) in mm	36.5 / 44		36.8 / 44	36.5 / 44	
Technical specifications acc. to IEC/DIN VDE					
• Max. load current in A / cross-section in mm ²	28 / 4	--	40 / 6		
• Rated impulse withstand voltage in kV / pollution degree	8 / 3				
• Overvoltage category / molded plastic group	III / I				
Connection capacities					
• Flexible with end sleeve, with plastic sleeve in mm ²	0.25 ... 2.5		0.25 ... 4		
• Flexible with end sleeve, without plastic sleeve in mm ²	0.25 ... 2.5		0.25 ... 4		
• Flexible with two-wire connection end sleeve, with plastic sleeve in mm ²	0.5		0.5 ... 1		
Stripped length in mm	10				
Plug gauge (IEC 60947-1)	A3		A4		
Molded plastic type	PA				
• Flammability Class acc. to UL 94	V0				
Approval data (UL/cUL and CSA)					
• Rated voltage / rated current / conductor sizes					
- UL/cUL: in V/A / AWG	600 / 20 / 26 ... 12	-- / -- / 26 ... 12	600 / 30 / 20 ... 10		
- CSA: in V/A / AWG	--				
Support rails/protective conductor busbars	--	see page 14/3, section "Support rails"	--	--	--

Terminal Blocks

8WH2 Spring-Loaded Terminals

8WH through-type terminals

	8WH2000-0CG07	8WH2003-0CG07	8WH2004-0CG07	8WH2000-0AH00 8WH2000-0AH01	8WH2003-0AH00 8WH2003-0AH01
Dimensions					
• Width/length/cover width in mm	6.2 / 56 / 2.2	6.2 / 71.5 / 2.2	6.2 / 87 / 2.2	8.2 / 69.5 / 2.2	8.2 / 90.5 / 2.2
• Height (NS 35/7.5 / NS 35/15) in mm	36.8 / 44	36.5 / 44		43.5 / 51	
Technical specifications acc. to IEC/DIN VDE					
• Max. load current in A / cross-section in mm ²	--			52 / 10	
• Rated impulse withstand voltage in kV / pollution degree	8 / 3				
• Overvoltage category / molded plastic group	III / I				
Connection capacities					
• Flexible with end sleeve, with plastic sleeve in mm ²	0.25 ... 4			0.25 ... 6	
• Flexible with end sleeve, without plastic sleeve in mm ²	0.25 ... 4			0.25 ... 6	
• Flexible with two-wire connection end sleeve, with plastic sleeve in mm ²	0.5 ... 1			0.5 ... 1.5	
Stripped length in mm	10			12	
Plug gauge (IEC 60947-1)	A4			A5	
Molded plastic type	PA				
• Flammability Class acc. to UL 94	V0				
Approval data (UL/cUL and CSA)					
• Rated voltage / rated current / conductor sizes					
- UL/cUL: in V/A / AWG	-- / -- / 20 ... 10			600 / 50 / 20 ... 8	
- CSA: in V/A / AWG	--				
Support rails/protective conductor busbars	see page 14/3, section "Support rails"	see page 14/3, section "Support rails"	see page 14/3, section "Support rails"	--	--
	8WH2000-0CH07	8WH2003-0CH07	8WH2000-0AJ00 8WH2000-0AJ01	8WH2000-0CJ07	
Dimensions					
• Width/length/cover width in mm	8.2 / 69.5 / 2.2	8.2 / 90.5 / 2.2	10 / 71.5 / 2.2		
• Height (NS 35/7.5 / NS 35/15) in mm	43.5 / 51		50.5 / 58		
Technical specifications acc. to IEC/DIN VDE					
• Max. load current in A / cross-section in mm ²	--		65 / 16		
• Rated impulse withstand voltage in kV / pollution degree	8 / 3				
• Overvoltage category / molded plastic group	III / I				
Connection capacities					
• Flexible with end sleeve, with plastic sleeve in mm ²	0.25 ... 6		0.25 ... 10		
• Flexible with end sleeve, without plastic sleeve in mm ²	0.25 ... 6		0.25 ... 10		
• Flexible with two-wire connection end sleeve, with plastic sleeve in mm ²	0.5 ... 1.5		1.5 ... 2.5		
Stripped length in mm	12		18		
Plug gauge (IEC 60947-1)	A5		A6		
Molded plastic type	PA				
• Flammability Class acc. to UL 94	V0				
Approval data (UL/cUL and CSA)					
• Rated voltage / rated current / conductor sizes					
- UL/cUL: in V/A / AWG	-- / -- / 20 ... 8		600 / 65 / 16 ... 6	-- / -- / 16 ... 6	
- CSA: in V/A / AWG	--				
Support rails/protective conductor busbars	see page 14/3, section "Support rails"	see page 14/3, section "Support rails"	--		see page 14/3, section "Support rails"
	8WH2000-0AK00 8WH2000-0AK01	8WH2000-0CK07	8WH2000-0AM00 8WH2000-0AM01	8WH2000-0CM07	
Dimensions					
• Width/length/cover width in mm	12 / 80 / 2.2		16 / 100 / --		
• Height (NS 35/7.5 / NS 35/15) in mm	51 / 58.5		59 / 66.5		
Technical specifications acc. to IEC/DIN VDE					
• Max. load current in A / cross-section in mm ²	90 / 25		125 / 35		
• Rated impulse withstand voltage in kV / pollution degree	8 / 3				
• Overvoltage category / molded plastic group	III / I				
Connection capacities					
• Flexible with end sleeve, with plastic sleeve in mm ²	0.25 ... 16		2.5 ... 35		
• Flexible with end sleeve, without plastic sleeve in mm ²	0.25 ... 16		2.5 ... 35		
• Flexible with two-wire connection end sleeve, with plastic sleeve in mm ²	1.5 ... 4		2.5 ... 10		
Stripped length in mm	18		25		
Plug gauge (IEC 60947-1)	A7		A8		
Molded plastic type	PA				
• Flammability Class acc. to UL 94	V0				
Approval data (UL/cUL and CSA)					
• Rated voltage / rated current / conductor sizes					
- UL/cUL: in V/A / AWG	600 / 85 / 16 ... 4	-- / -- / 16 ... 4	600 / 115 / 14 ... 2	-- / -- / 14 ... 2	
- CSA: in V/A / AWG	--		600 / 115 / 14 ... 2	-- / -- / 14 ... 2	
Support rails/protective conductor busbars	--	see page 14/3, section "Support rails"	--		see page 14/3, section "Support rails"

Selection and ordering data

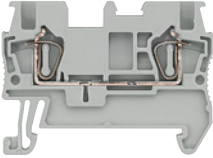
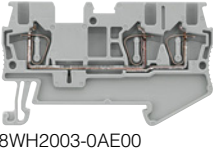
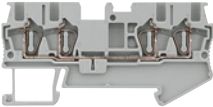
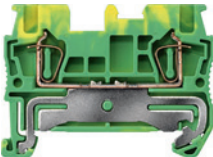
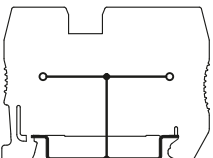
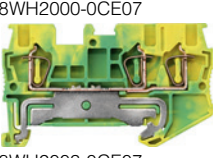
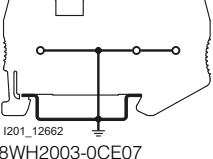
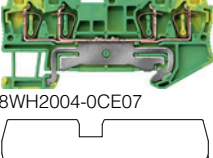
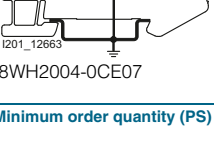
Version	SD	Article No. www.siemens.com/ product?Article No.	Price per PU	PU (UNIT, SET, M)	PS	PG
Terminal size 1.5 mm²						
Through-type terminals, terminal size 1.5 mm²						
<ul style="list-style-type: none"> Terminal width 4.2 mm, c_{ALUS} IEC 60947-7-1 <ul style="list-style-type: none"> Rigid 0.08 ... 1.5 mm² Flexible 0.08 ... 1.5 mm² AWG 28 ... 16 $I = 17.5 \text{ A}$ The total current through all connected conductors must not exceed the max. load current $U = 500 \text{ V}$ 						
8WH2000-0AE00						
						
8WH2003-0AE00						
						
8WH2004-0AE00						
						
Versions <ul style="list-style-type: none"> Two clamping points <ul style="list-style-type: none"> Gray Blue Orange Red Black Green White Yellow 						
<ul style="list-style-type: none"> Three clamping points <ul style="list-style-type: none"> Gray, Ⓢ Blue Orange 						
<ul style="list-style-type: none"> Four clamping points <ul style="list-style-type: none"> Gray, Ⓢ Blue Orange 						
<ul style="list-style-type: none"> Two clamping points, Ⓢ Three clamping points Four clamping points, Ⓢ 						
8WH2000-0AE00 1 50 units 1BT 8WH2000-0AE01 1 50 units 1BT 8WH2000-0AE04 1 50 units 1BT 8WH2000-0AE02 1 50 units 1BT 8WH2000-0AE08 1 50 units 1BT 8WH2000-0AE03 1 50 units 1BT 8WH2000-0AE05 1 50 units 1BT 8WH2000-0AE06 1 50 units 1BT						
8WH2003-0AE00 1 50 units 1BT 8WH2003-0AE01 1 50 units 1BT 8WH2003-0AF04 1 50 units 1BT						
8WH2004-0AE00 1 50 units 1BT 8WH2004-0AE01 1 50 units 1BT 8WH2004-0AF04 1 50 units 1BT						
PE through-type terminals, terminal size 1.5 mm²						
<ul style="list-style-type: none"> Terminal width 4.2 mm, c_{ALUS} IEC 60947-7-1 <ul style="list-style-type: none"> Rigid 0.08 ... 1.5 mm² Flexible 0.08 ... 1.5 mm² AWG 28 ... 16 Green-yellow 						
8WH2000-0CE07						
						
8WH2000-0CE07						
						
8WH2003-0CE07						
						
8WH2003-0CE07						
						
8WH2004-0CE07						
						
8WH2004-0CE07						
						
8WH2000-0CE07 1 50 units 1BT 8WH2003-0CE07 1 50 units 1BT 8WH2004-0CE07 1 50 units 1BT						

Terminal Blocks

8WH2 Spring-Loaded Terminals



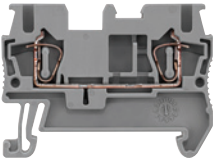
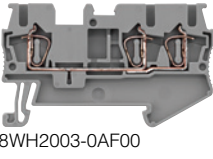
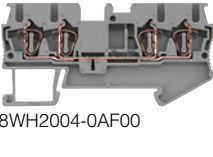

8WH through-type terminals

Version	SD	Article No. www.siemens.com/ product?Article No.	Price per PU	PU (UNIT, SET, M)	PS	PG
Terminal size 2.5 mm²						
 <p>8WH2000-0AF00</p>	Through-type terminals, terminal size 2.5 mm², two clamping points <ul style="list-style-type: none"> Terminal width 5.2 mm, c_{ULUS} IEC 60947-7-1 <ul style="list-style-type: none"> Rigid 0.08 ... 4 mm² Flexible 0.08 ... 2.5 mm² AWG 28 ... 12 $I = 31$ A $U = 800$ V 					
	Versions <ul style="list-style-type: none"> Gray Blue Orange Red Black Green White Yellow 		8WH2000-0AF00 8WH2000-0AF01 8WH2000-0AF04 8WH2000-0AF02 8WH2000-0AF08 8WH2000-0AF03 8WH2000-0AF05 8WH2000-0AF06	1 1 1 1 1 1 1 1	50 units 50 units 50 units 50 units 50 units 50 units 50 units 50 units	1BT 1BT 1BT 1BT 1BT 1BT 1BT 1BT
 <p>8WH2003-0AF00</p>	Through-type terminals, terminal size 2.5 mm², three clamping points <ul style="list-style-type: none"> Terminal width 5.2 mm, c_{ULUS} IEC 60947-7-1 <ul style="list-style-type: none"> Rigid 0.08 ... 4 mm² Flexible 0.08 ... 2.5 mm² AWG 28 ... 12 $I = 28$ A The total current through all connected conductors must not exceed the max. load current $U = 800$ V 					
	Versions <ul style="list-style-type: none"> Gray Blue Orange 		8WH2003-0AF00 8WH2003-0AF01 8WH2003-0AF04	1 1 1	50 units 50 units 50 units	1BT 1BT 1BT
 <p>8WH2004-0AF00</p>	Through-type terminals, terminal size 2.5 mm², four clamping points <ul style="list-style-type: none"> Terminal width 5.2 mm, c_{ULUS} IEC 60947-7-1 <ul style="list-style-type: none"> Rigid 0.08 ... 4 mm² Flexible 0.08 ... 2.5 mm² AWG 28 ... 12 $I = 28$ A The total current through all connected conductors must not exceed the max. load current $U = 800$ V 					
	Versions <ul style="list-style-type: none"> Gray Blue Orange 		8WH2004-0AF00 8WH2004-0AF01 8WH2004-0AF04	1 1 1	50 units 50 units 50 units	1BT 1BT 1BT

Terminal Blocks

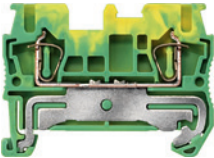
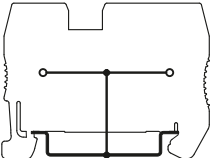
8WH2 Spring-Loaded Terminals

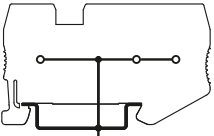

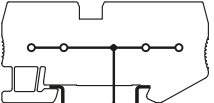



8WH through-type terminals

Version	SD	Article No. www.siemens.com/ product?Article.No.	Price per PU	PU (UNIT, SET, M)	PS	PG
PE through-type terminals, terminal size 2.5 mm² <ul style="list-style-type: none"> Terminal width 5.2 mm Class II IEC 60947-7-2 <ul style="list-style-type: none"> Rigid 0.08 ... 4 mm² Flexible 0.08 ... 2.5 mm² AWG 28 ... 12 Green-yellow 						
Versions <ul style="list-style-type: none"> Two clamping points Three clamping points Four clamping points 						
 8WH2000-OCF07						
 <small>I201_12664</small> 8WH2000-OCF07						
 8WH2003-OCF07						
 <small>I201_12665</small> 8WH2003-OCF07						
 8WH2004-OCF07						
 <small>I201_12666</small> 8WH2004-OCF07						
		8WH2000-OCF07 8WH2003-OCF07 8WH2004-OCF07		1 50 units 1BT 1 50 units 1BT 1 50 units 1BT		

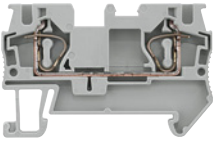
Terminal Blocks

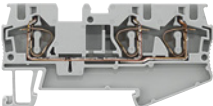
8WH2 Spring-Loaded Terminals

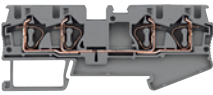



8WH through-type terminals

Version	SD	Article No. www.siemens.com/ product?Article.No.	Price per PU	PU (UNIT, SET, M)	PS	PG
Terminal size 4 mm²						
 <p>8WH2000-0AG00</p>	Through-type terminals, terminal size 4 mm², two clamping points <ul style="list-style-type: none"> Terminal width 6.2 mm  IEC 60947-7-1 <ul style="list-style-type: none"> Rigid 0.08 ... 6 mm², flexible 0.08 ... 4 mm², AWG 28 ... 10 $I = 40$ A, $U = 800$ V 					
	Versions <ul style="list-style-type: none"> Gray Blue Orange Red Black Green White Yellow 		8WH2000-0AG00 8WH2000-0AG01 8WH2000-0AG04 8WH2000-0AG02 8WH2000-0AG08 8WH2000-0AG03 8WH2000-0AG05 8WH2000-0AG06	 	 	
 <p>8WH2003-0AG00</p>	Through-type terminals, terminal size 4 mm², three clamping points <ul style="list-style-type: none"> Terminal width 6.2 mm  IEC 60947-7-1 <ul style="list-style-type: none"> Rigid 0.08 ... 6 mm², flexible 0.08 ... 4 mm², AWG 28 ... 10 $I = 40$ A, the total current through all connected conductors must not exceed the maximum load current $U = 800$ V 					
	Versions <ul style="list-style-type: none"> Gray Blue 		8WH2003-0AG00 8WH2003-0AG01	 	 	
 <p>8WH2004-0AG00</p>	Through-type terminals, terminal size 4 mm², four clamping points <ul style="list-style-type: none"> Terminal width 6.2 mm  IEC 60947-7-1 <ul style="list-style-type: none"> Rigid 0.08 ... 6 mm², flexible 0.08 ... 4 mm², AWG 28 ... 10 $I = 40$ A, the total current through all connected conductors must not exceed the maximum load current $U = 800$ V 					
	Versions <ul style="list-style-type: none"> Gray Blue 		8WH2004-0AG00 8WH2004-0AG01	 	 	

Terminal Blocks

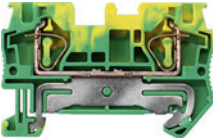
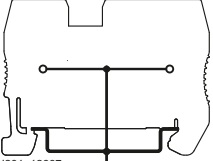
8WH2 Spring-Loaded Terminals

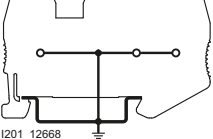

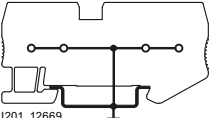





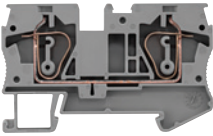

8WH through-type terminals

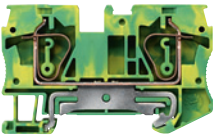
Version	SD	Article No. www.siemens.com/ product?Article No.	Price per PU	PU (UNIT, SET, M)	PS	PG				
 <p>8WH2000-0CG07</p>	d	<p>PE through-type terminals, terminal size 4 mm²</p> <ul style="list-style-type: none"> Terminal width 6.2 mm UL 480 IEC 60947-7-2 <ul style="list-style-type: none"> Rigid 0.08 ... 6 mm² Flexible 0.08 ... 4 mm² AWG 28 ... 10 Green-yellow 								
<p>Versions</p> <ul style="list-style-type: none"> Two clamping points Three clamping points Four clamping points 							<p>8WH2000-0CG07</p>	1	50 units	1BT
 <p>I201_12667 8WH2000-0CE07</p>							<p>8WH2003-0CG07</p>	1	50 units	1BT
 <p>8WH2003-0CG07</p>							<p>8WH2004-0CG07</p>	1	50 units	1BT
 <p>I201_12668 8WH2003-0CG07</p>										
 <p>8WH2004-0CG07</p>										
 <p>I201_12669 8WH2004-0CG07</p>										

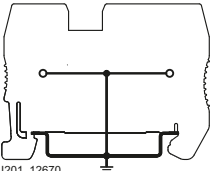
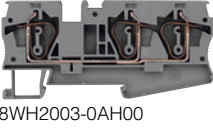
Terminal Blocks

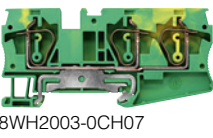
8WH2 Spring-Loaded Terminals

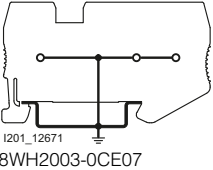
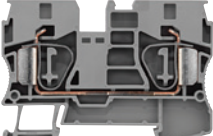





8WH through-type terminals

Version	SD	Article No. www.siemens.com/ product?Article No.	Price per PU	PU (UNIT, SET, M)	PS	PG
Terminal size 6 mm²						
 <p>8WH2000-0AH00</p>		Through-type terminals, terminal size 6 mm², two clamping points <ul style="list-style-type: none"> Terminal width 8.2 mm  IEC 60947-7-1 <ul style="list-style-type: none"> Rigid 0.2 ... 10 mm² Flexible 0.2 ... 6 mm² AWG 24 ... 8 I = 52 A U = 1000 V 				
Versions <ul style="list-style-type: none"> Gray Blue 		8WH2000-0AH00 8WH2000-0AH01		1 50 units	1BT	1BT
 <p>8WH2000-0CH07</p>		PE through-type terminals, terminal size 6 mm², two clamping points <ul style="list-style-type: none"> Terminal width 8.2 mm  IEC 60947-7-2 <ul style="list-style-type: none"> Rigid 0.2 ... 10 mm² Flexible 0.2 ... 6 mm² AWG 24 ... 8 Green-yellow 				
 <p>1201_12670 8WH2000-0CE07</p>			8WH2000-0CH07	1 50 units	1BT	1BT
 <p>8WH2003-0AH00</p>		Through-type terminals, terminal size 6 mm², three clamping points <ul style="list-style-type: none"> Terminal width 8.2 mm  IEC 60947-7-1 <ul style="list-style-type: none"> Rigid 0.2 ... 10 mm² Flexible 0.2 ... 6 mm² AWG 24 ... 8 I = 52 A The total current through all connected conductors must not exceed the max. load current U = 1000 V 				
Versions <ul style="list-style-type: none"> Gray Blue 		8WH2003-0AH00 8WH2003-0AH01		1 50 units	1BT	1BT
 <p>8WH2003-0CH07</p>		PE through-type terminals, terminal size 6 mm², three clamping points <ul style="list-style-type: none"> Terminal width 8.2 mm  IEC 60947-7-2 <ul style="list-style-type: none"> Rigid 0.2 ... 10 mm² Flexible 0.2 ... 6 mm² AWG 24 ... 8 Green-yellow 				
 <p>1201_12671 8WH2003-0CE07</p>			8WH2003-0CH07	1 50 units	1BT	1BT
Terminal size 10 mm²						
 <p>8WH2000-0AJ00</p>		Through-type terminals, terminal size 10 mm² <ul style="list-style-type: none"> Terminal width 10.2 mm  IEC 60947-7-1 <ul style="list-style-type: none"> Rigid 1.5 ... 16 mm² Flexible 1.5 ... 10 mm² AWG 24 ... 6 I = 65 A U = 1000 V 				
Versions <ul style="list-style-type: none"> Gray Blue 		8WH2000-0AJ00 8WH2000-0AJ01		1 50 units	1BT	1BT

Terminal Blocks

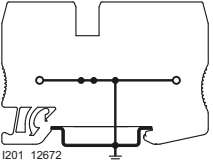
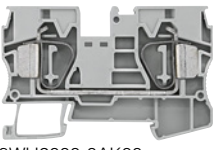
8WH2 Spring-Loaded Terminals



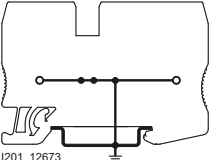



8WH through-type terminals

Version	SD	Article No. www.siemens.com/ product?Article.No.	Price per PU	PU (UNIT, SET, M)	PS	PG
 <p>8WH2000-0CJ07</p> <p>PE through-type terminals, terminal size 10 mm²</p> <ul style="list-style-type: none"> Terminal width 10.2 mm  IEC 60947-7-2 <ul style="list-style-type: none"> Rigid 1.5 ... 16 mm² Flexible 1.5 ... 10 mm² AWG 24 ... 6 I = 65 A Green-yellow  <p>I201_12672 8WH2000-0CJ07</p>	d	8WH2000-0CJ07		1	50 units	1BT
 <p>8WH2000-0AK00</p> <p>Through-type terminals, terminal size 16 mm²</p> <ul style="list-style-type: none"> Terminal width 12 mm  IEC 60947-7-1 <ul style="list-style-type: none"> Rigid 1.5 ... 25 mm² Flexible 1.5 ... 16 mm² AWG 24 ... 4 I = 90 A U = 1000 V <p>Versions</p> <ul style="list-style-type: none"> Gray Blue 		8WH2000-0AK00 8WH2000-0AK01		1	50 units	1BT
 <p>8WH2000-0CK07</p> <p>PE through-type terminals, terminal size 16 mm²</p> <ul style="list-style-type: none"> Terminal width 12 mm  IEC 60947-7-2 <ul style="list-style-type: none"> Rigid 1.5 ... 25 mm² Flexible 1.5 ... 16 mm² AWG 24 ... 4 I = 90 A Green-yellow  <p>I201_12673 8WH2000-0CK07</p>		8WH2000-0CK07		1	25 units	1BT

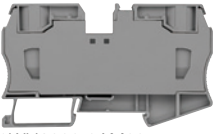
Terminal Blocks

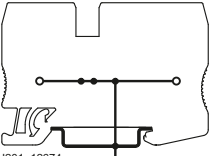
8WH2 Spring-Loaded Terminals

8WH through-type terminals

Version	SD	Article No. www.siemens.com/ product?Article.No.	Price per PU	PU (UNIT, SET, M)	PS	PG
Terminal size 35 mm²						
 8WH2000-0AM00		Through-type terminals, terminal size 35 mm² <ul style="list-style-type: none">Terminal width 16 mmUL, CE, RoHSIEC 60947-7-1<ul style="list-style-type: none">Rigid 2.5 ... 35 mm²Flexible 2.5 ... 35 mm²AWG 14 ... 2I = 125 AU = 1000 VEnclosed at both ends				
Versions						
		• Gray, ☉	8WH2000-0AM00	1	10 units	1BT
		• Blue	8WH2000-0AM01	1	10 units	1BT
 8WH2000-0CM07		PE through-type terminals, terminal size 35 mm² <ul style="list-style-type: none">Terminal width 16 mmUL, CE, RoHSIEC 60947-7-2<ul style="list-style-type: none">Rigid 2.5 ... 35 mm²Flexible 2.5 ... 35 mm²AWG 14 ... 2I = 125 AEnclosed at both endsGreen-yellow				
Versions						
			8WH2000-0CM07	1	10 units	1BT
 1201_12674 8WH2000-0CM07						
Accessories						
 8WH9070-0AA00		Compartment partitions <ul style="list-style-type: none">For visual and electrical separation of terminal groups2 mm thick				
Versions						
		• For terminal sizes 1.5 ... 4 mm ² and two clamping points	8WH9070-0AA00	100	50 units	1BT
		• For terminal sizes 1.5 ... 4 mm ² and three clamping points	8WH9070-0GA00	100	50 units	1BT
		• For terminal sizes 1.5 ... 4 mm ² and four clamping points	8WH9070-0HA00	100	50 units	1BT
		• For terminal size 6 mm ²	8WH9070-0DA00	100	50 units	1BT
 8WH9000-1GA00		Covers Gray				
Versions						
		• For terminal sizes 1.5 ... 2.5 mm ² and two clamping points	8WH9000-1GA00	100	50 units	1BT
		• For terminal sizes 1.5 ... 2.5 mm ² and three clamping points	8WH9000-2GA00	100	50 units	1BT
		• For terminal sizes 1.5 ... 2.5 mm ² and four clamping points	8WH9000-4GA00	100	50 units	1BT
		• For terminal size 4 mm ² and two clamping points	8WH9003-1GA00	100	50 units	1BT
		• For terminal size 4 mm ² and three clamping points	8WH9003-2GA00	100	50 units	1BT
		• For terminal size 4 mm ² and four clamping points	8WH9003-4GA00	100	50 units	1BT
		• For terminal size 6 mm ² and two clamping points	8WH9004-1GA00	100	50 units	1BT
		• For terminal size 6 mm ² and three clamping points	8WH9004-2GA00	100	50 units	1BT
		• For terminal size 10 mm ²	8WH9005-1GA00	100	50 units	1BT
		• For terminal size 16 mm ²	8WH9006-1GA00	100	50 units	1BT
 8WH9000-0GA00		Cover segments <ul style="list-style-type: none">GrayFor covering multi-wire terminals when mounting two-wire terminals side-by-side				
Versions						
		• For terminal sizes 1.5 ... 2.5 mm ²	8WH9000-0GA00	100	10 units	1BT
		• For terminal size 4 mm ²	8WH9003-0GA00	100	10 units	1BT
 8WH9061-5AA06		Warning covers Note: For the operating shafts of 8WH2 through-type terminals				
Versions						
		• For terminal size 1.5 mm ²	8WH9061-5AA06	100	50 units	1BT
		• For terminal size 2.5 mm ²	8WH9060-5AA06	100	50 units	1BT
		• For terminal size 4 mm ²	8WH9063-5AA06	100	50 units	1BT
		• For terminal size 6 mm ²	8WH9064-5AA06	100	10 units	1BT
		• For terminal size 10 mm ²	8WH9065-5AA06	100	25 units	1BT
		• For terminal size 16 mm ²	8WH9066-5AA06	100	25 units	1BT
		• For terminal size 35 mm ²	8WH9067-5AA06	100	10 units	1BT

For general accessories for 8WH terminal blocks, see page 14/135.

Overview

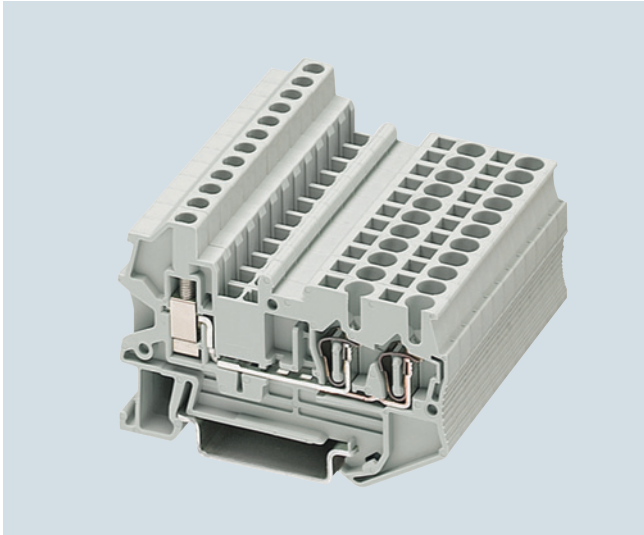

The terminal connection compartment, on the spring-loaded side as well as on the screw side, enables connection to a nominal cross-section of 2.5 mm² or 4 mm², with or without end sleeves. The advantages of the different connection types are due to the fact that the spring-loaded terminal of the hybrid through-type terminal is used inside the control cabinet and the universal screw terminal is used at the end-user's side. A PE terminal with the same contour is available for the three-wire terminal. Contact is made by simply snapping the terminal onto the support rail.

This meets the following requirements of IEC 60947-7-2:

- Low contact resistance
- Stainless clamping points
- Green-yellow enclosure
- Additional inscription options

A label can be snapped on to the middle of each terminal at the front. Further labels can also be mounted flat on the side of the terminals.

Technical specifications

	8WH2103-2BF00 8WH2103-2BF01	8WH2103-3BF07	8WH2103-2BG00 8WH2103-2BG01	8WH2103-3BG07
Dimensions				
• Width/length/cover width in mm	5.2 / 65.3 / 2.2		6.2 / 74.4 / 2.2	
• Height (NS 35/7.5 / NS 35/15) in mm	42.8 / 50.3			
Technical specifications acc. to IEC/DIN VDE				
• Max. load current in A / cross-section in mm ²	28 / 4	--	32 / 6	--
• Rated impulse withstand voltage in kV / pollution degree	8 / 3			
• Overvoltage category / molded plastic group	III / I			
Connection capacities				
• Flexible with end sleeve, with plastic sleeve in mm ²	0.25 ... 2.5		0.25 ... 4	
• Flexible with end sleeve, without plastic sleeve in mm ²	0.25 ... 2.5		0.25 ... 4	
• Flexible with two-wire connection end sleeve, with plastic sleeve in mm ²	0.5 ... 1			
Stripped length in mm	10			
Plug gauge (IEC 60947-1)	A3		A4	
Connection capacity of screw terminal				
• Flexible with end sleeves with/without plastic sleeve in mm ²	0.25 ... 2.5 / 0.25 ... 2.5		0.25 ... 4 / 0.25 ... 4	
Multi-conductor connection (two conductors of same cross-section)				
• Rigid / flexible in mm ²	0.14 ... 1.5 / 0.14 ... 1.5			
• Flexible with end sleeve, without plastic sleeve in mm ²	0.25 ... 1.5			
• Flexible with two-wire connection end sleeve, with plastic sleeve in mm ²	0.5 ... 1.5		0.5 ... 2.5	
Stripped length in mm	9			
Plug gauge (IEC 60947-1)	A3		A4	
Tightening torque in Nm	0.6 ... 0.8		0.6 ... 0.8	
Molded plastic type	PA			
• Flammability Class acc. to UL 94	V0			
Approval data (UL/cUL and CSA)				
• Rated voltage / rated current / conductor sizes				
- UL/cUL: in V/A / AWG	Applied for			
- CSA: in V/A / AWG	Applied for			
Support rails/protective conductor busbars	--	see page 14/3, section "Support rails"	--	see page 14/3, section "Support rails"

Terminal Blocks

8WH2 Spring-Loaded Terminals

8WH hybrid through-type terminals



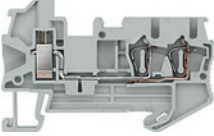
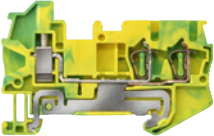
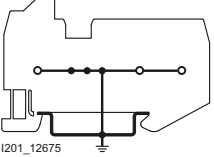

Selection and ordering data

Version	SD	Article No. www.siemens.com/ product?Article No.	Price per PU	PU (UNIT, SET, M)	PS	PG	
d							
Terminal size 2.5 mm²							
 <p>8WH2103-2BF00</p>	Hybrid through-type terminals, terminal size 2.5 mm² <ul style="list-style-type: none"> Terminal width 5.2 mm IEC 60947-7-1 Spring <ul style="list-style-type: none"> Rigid 0.08 ... 4 mm² Flexible 0.08 ... 2.5 mm² AWG 28 ... 12 I = 28 A The total current through all connected conductors must not exceed the max. load current U = 800 V Screw <ul style="list-style-type: none"> Rigid 0.14 ... 4 mm² Flexible 0.14 ... 2.5 mm² AWG 26 ... 14 I = 28 A U = 800 V 						
	Versions <ul style="list-style-type: none"> Gray Blue 						8WH2103-2BF00 8WH2103-2BF01
 <p>8WH2103-3BF07</p>	PE hybrid through-type terminals, terminal size 2.5 mm² <ul style="list-style-type: none"> Terminal width 5.2 mm IEC 60947-7-2 Spring <ul style="list-style-type: none"> Rigid 0.08 ... 4 mm² Flexible 0.08 ... 2.5 mm² AWG 28 ... 12 Screw <ul style="list-style-type: none"> Rigid 0.14 ... 4 mm² Flexible 0.14 ... 2.5 mm² AWG 26 ... 14 						8WH2103-3BF07
	 <p>1201_12675 8WH2103-3BF07</p>						

Terminal Blocks

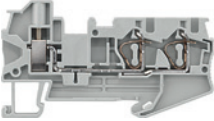
8WH2 Spring-Loaded Terminals

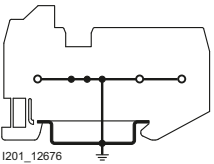
8WH hybrid through-type terminals

Version	SD	Article No. www.siemens.com/ product?Article.No.	Price per PU	PU (UNIT, SET, M)	PS	PG
d						
Terminal size 4 mm²						
 <p>8WH2103-2BG00</p>		<p>Hybrid through-type terminals, terminal size 4 mm²</p> <ul style="list-style-type: none"> Terminal width 6.2 mm IEC 60947-7-1 Spring <ul style="list-style-type: none"> Rigid 0.08 ... 6 mm² Flexible 0.08 ... 4 mm² AWG 28 ... 10 I = 32 A The total current through all connected conductors must not exceed the max. load current U = 800 V Screw <ul style="list-style-type: none"> Rigid 0.14 ... 6 mm² Flexible 0.14 ... 4 mm² AWG 26 ... 10 I = 32 A U = 800 V <p>Versions</p> <ul style="list-style-type: none"> Gray Blue 				
		8WH2103-2BG00		1	50 units	1BT
		8WH2103-2BG01		1	50 units	1BT
 <p>8WH2103-3BG07</p>  <p>1201_12676 8WH2103-3BG07</p>		<p>PE hybrid through-type terminals, terminal size 4 mm²</p> <ul style="list-style-type: none"> Terminal width 6.2 mm IEC 60947-7-2 Spring <ul style="list-style-type: none"> Rigid 0.08 ... 6 mm² Flexible 0.08 ... 4 mm² AWG 28 ... 10 Screw <ul style="list-style-type: none"> Rigid 0.14 ... 6 mm² Flexible 0.14 ... 4 mm² AWG 26 ... 10 				
		8WH2103-3BG07		1	50 units	1BT
Accessories						
 <p>8WH9000-2HA00</p>		<p>Covers Gray</p> <p>Versions</p> <ul style="list-style-type: none"> For terminal size 2.5 mm² and three clamping points For terminal size 4 mm² and three clamping points 				
		8WH9000-2HA00		100	50 units	1BT
		8WH9003-2HA00		100	50 units	1BT

For general accessories for 8WH terminal blocks, see page 14/135.

Terminal Blocks

8WH2 Spring-Loaded Terminals

8WH fuse terminals

Overview

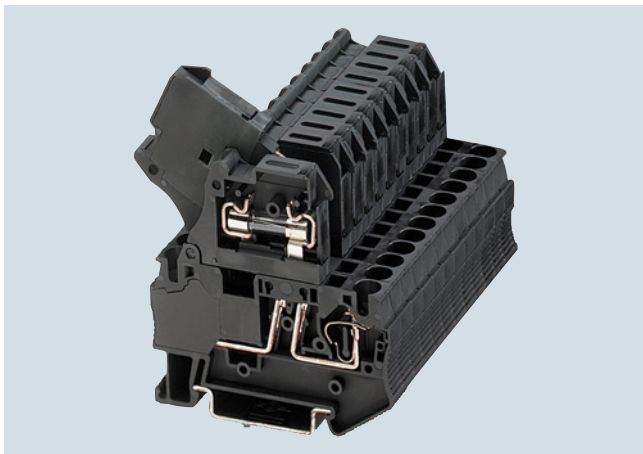

Fuse terminals for blade-type fuses

The fuse terminals for blade-type fuses accommodate blade-type fuses according to ISO/DIS 8820 / DIN 72581-3. Terminals with LED display are available for fast fault diagnosis "at a glance".

Fuse terminals for G fuse links

Fuse terminals perform two important tasks in connected electrical systems. Firstly, they act as a fuse carrier and, secondly, as a potential distributor.

The full-length bridge shaft enables uninterrupted bridging between the through-type terminals and the fuse terminals.

Fuse terminals for G fuse links are available for standardized electrical fuse formats 5 × 20 mm and 6.3 × 32 mm (inch fuse) – and are optionally available with LED display to signal a blown fuse.

A label can be snapped on to the middle of the terminal at the front. Further labels can also be mounted flat on the side of the terminals.









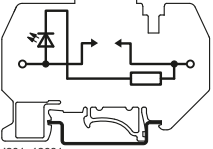

Fuses must not be replaced under load.

Technical specifications

	8WH2000-1AG08 8WH2000-1BG28 8WH2000-1BG38	8WH2000-1GG08 8WH2000-1JG38 8WH2000-1JG68 8WH2000-1MG08	8WH2000-1HG08 8WH2000-1NG38 8WH2000-1NG68 8WH2000-1RG08
Dimensions			
• Width/length in mm	8.2 / 86.5	6.2 / 61.5	8.2 / 76.5
• Height (NS 35/7.5 / NS 35/15) in mm	43.5 / 51	62.5 / 70	69 / 76.5
Technical specifications acc. to IEC/DIN VDE			
• Fuse type ISO/DIS 8820 / DIN 72581-3 / dimensions in mm	C	G / 5 × 20	G / 6.3 × 32
• Maximum current for single arrangement in A	30	3.3	10
Max. power loss at 23 °C acc. to IEC 60647-7-3 in W ¹⁾			
• U in V	--	250	400
• Overload protection			
- Individually in W	--	1.6	
- As group in W	--	1.6	
• Only short-circuit protection			
- Individually in W	--	4	
- As group in W	--	2.5	
• I _{max} in A	--	6.3	10
• Rated impulse withstand voltage in kV / pollution degree	6 / 3	4 / 3	6 / 3
• Overvoltage category / molded plastic group	III / I		
Connection capacities			
• Flexible with end sleeves with/without plastic sleeve in mm ²	0.25 ... 4 / 0.25 ... 4		
• Flexible with two-wire connection end sleeve, with plastic sleeve in mm ²	0.5		
Stripped length in mm	10		
Plug gauge (IEC 60947-1)	A4	A3	A4
Molded plastic type	PA		
• Flammability Class acc. to UL 94	V0		
Approval data (UL/cUL and CSA)			
• Rated voltage / rated current / conductor sizes			
- UL/cUL: in V/A / AWG	600 / 30 / 24 ... 10	300 / 6.3 / 24 ... 10	300 / 10 / 24 ... 10
- CSA: in V/A / AWG	--		

¹⁾ Please note: The G fuse holders must be selected according to the maximum power loss (heat dissipation) of the G fuse links. Depending on the application and method of installation, the heat rise conditions in closed fuse holders must be tested. Higher ambient temperatures represent an additional load for the fuse links. A shift in rated current should therefore be taken into account in such applications. When selecting G fuse links, make sure that they do not exceed the specified maximum power loss. For specification details, contact the fuse manufacturer.

Selection and ordering data

Version	SD	Article No. www.siemens.com/ product?Article No.	Price per PU	PU (UNIT, SET, M)	PS	PG
Terminal size 4 mm²						
 <p>8WH2000-1AG08</p>  <p>8WH2000-1BG28</p>  <p>1201_12681 8WH2000-1BG28</p>		Fuse terminals, terminal size 4 mm², for blade-type fuses acc. to ISO/DIS8820/DIN72581-3 <ul style="list-style-type: none"> Terminal width 8.2 mm  Connection data <ul style="list-style-type: none"> Rigid 0.08 ... 6 mm² Flexible 0.08 ... 4 mm² AWG 28 ... 10 I = 30 A U = 400 V Enclosed at both ends Versions <ul style="list-style-type: none"> Without LED display LED display 12 V LED display 24 V 				
		8WH2000-1AG08 8WH2000-1BG28 8WH2000-1BG38		1 50 units 1 50 units 1 50 units	1BT 1BT 1BT	
 <p>8WH2000-1GG08</p>  <p>8WH2000-1JG38</p>		Fuse terminals, terminal size 4 mm², for 5 x 20 mm G fuse links <ul style="list-style-type: none"> Terminal width 6.2 mm  IEC 60947-7-3 With fuse <ul style="list-style-type: none"> Rigid 0.08 ... 6 mm², flexible 0.08 ... 4 mm², AWG 28 ... 10 I_{max} = 6.3 A, only short-circuit protection, single 4 W, group 2.5 W U = 250 V, overload protection, single 4 W, group 1.6 W As isolating terminal <ul style="list-style-type: none"> Rigid 0.08 ... 6 mm², flexible 0.08 ... 4 mm², AWG 28 ... 10 I = 6.3 A, U = 250 V Enclosed at both ends Versions <ul style="list-style-type: none"> Without LED display LED display 15 ... 30 V LED display 30 ... 60 V LED display 110 ... 250 V 				
		8WH2000-1GG08 8WH2000-1JG38 8WH2000-1JG68 8WH2000-1MG08		1 50 units 1 50 units 1 50 units 1 50 units	1BT 1BT 1BT 1BT	
 <p>8WH2000-1HG08</p>		Fuse terminals, terminal size 4 mm², for G fuse links 6.3 x 32 mm (inch fuses) <ul style="list-style-type: none"> Terminal width 8.2 mm  IEC 60947-7-3 With fuse <ul style="list-style-type: none"> Rigid 0.08 ... 6 mm², flexible 0.08 ... 4 mm², AWG 28 ... 10 I = 10 A, U = 400 V Current and voltage are determined by the fitted fuse or the selected LED display As isolating terminal <ul style="list-style-type: none"> Rigid 0.08 ... 6 mm², flexible 0.08 ... 4 mm², AWG 28 ... 10 I = 10 A, U = 400 V Enclosed at both ends Versions <ul style="list-style-type: none"> Without LED display With LED display 100 ... 250 V 				
		8WH2000-1HG08 8WH2000-1RG08		1 50 units 1 50 units	1BT 1BT	
Accessories						
 <p>8WH9070-0AA00</p>		Compartment partitions, for terminal sizes 1.5 and 4 mm² Versions <ul style="list-style-type: none"> Two clamping points 				
		8WH9070-0AA00		100 50 units	1BT	

For general accessories for 8WH terminal blocks, see [page 14/135](#).

Minimum order quantity (PS) or a multiple thereof can be ordered.

Terminal Blocks

8WH2 Spring-Loaded Terminals

8WH isolating blade terminals

Overview



Through-type terminals with isolating blade capability are the most commonly used terminal types in measuring and control technology.

The isolating blade terminals with nominal cross-section of 2.5 mm² are characterized in particular by their slim design of 5.2 mm and their high current-carrying capacity of 16 A. In addition the terminals provide a test tap parallel to the isolation point for 2.3-mm-Ø-test plugs. Potential distributors can be conveniently assembled using connecting combs.

Terminals with three and four clamping points are available for multi-conductor connection. With their compact design these terminals can also be used in small terminal boxes and their front connection arrangement enables user-friendly wiring.

The isolating blade is secured to the terminal so that it cannot be lost.







A label can be snapped on to the middle of the terminal at the front. Further labels can also be mounted flat on the side of the terminals.

The isolating element must not be replaced under load.

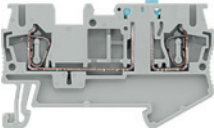
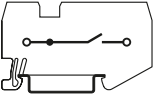
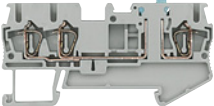
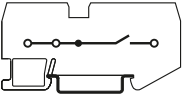
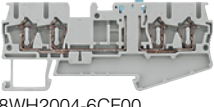
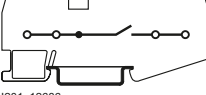
Technical specifications

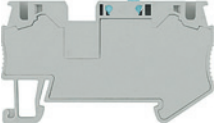
	8WH2000-6CF00	8WH2500-6CF00	8WH2003-6CF00	8WH2004-6CF00	8WH2000-6CG00
Dimensions					
• Width/length/cover width in mm	5.2 / 60.5 / 2.2	5.2 / 51 / 2.2	5.2 / 72 / 2.2	5.2 / 84 / 2.2	6.2 / 61.5 / --
• Height (NS 35/7.5 / NS 35/15) in mm	36.5 / 44	43 / 50.5	36.5 / 44		
Technical specifications acc. to IEC/DIN VDE					
• Max. load current in A / cross-section in mm ²	16 / 4				16 / 6
• Rated impulse withstand voltage in kV / pollution degree	6 / 3				
• Overvoltage category / molded plastic group	III / I				
Connection capacities					
• Flexible with end sleeve, with plastic sleeve in mm ²	0.25 ... 2.5				0.25 ... 4
• Flexible with end sleeve, without plastic sleeve in mm ²	0.25 ... 2.5				0.25 ... 4
• Flexible with two-wire connection end sleeve, with plastic sleeve in mm ²	0.5				
Stripped length in mm	10				
Plug gauge (IEC 60947-1)	A4	A3	A4	A3	
Molded plastic type					
• Flammability Class acc. to UL 94	PA				V0
Approval data (UL/cUL and CSA)					
• Rated voltage / rated current / conductor sizes					
- UL/cUL: in V/A / AWG	600 / 16 / 26 ... 12	600 / 16 / 24 ... 12	600 / 16 / 26 ... 12		300 / 6.3 / 24 ... 10
- CSA: in V/A / AWG	--				

Selection and ordering data

Version	SD	Article No. www.siemens.com/ product?Article No.	Price per PU	PU (UNIT, SET, M)	PS	PG
d						
Terminal size 2.5 mm²						
 8WH2000-6CF00  I201_12684 8WH2000-6CF00  8WH2003-6CF00  I201_12685 8WH2003-6CF00  8WH2004-6CF00  I201_12686 8WH2004-6CF00	Isolating blade terminals, terminal size 2.5 mm² <ul style="list-style-type: none"> Terminal width 5.2 mm  IEC 60947-7-1 <ul style="list-style-type: none"> Rigid 0.08 ... 4 mm² Flexible 0.08 ... 2.5 mm² AWG 28 ... 12 I = 16 A U = 400 V For 3 and 4 clamping points: <ul style="list-style-type: none"> Rigid 0.14 ... 4 mm² Flexible 0.14 ... 2.5 mm² AWG 26 ... 14 Versions <ul style="list-style-type: none"> Gray <ul style="list-style-type: none"> Two clamping points Three clamping points Four clamping points Note On terminals with three and four clamping points, the total current through all connected conductors must not exceed the max. load current.	8WH2000-6CF00 8WH2003-6CF00 8WH2004-6CF00		1 50 units 1BT 1 50 units 1BT 1 50 units 1BT		
 8WH2000-6CG00	Isolating blade terminals, terminal size 4 mm², two clamping points <ul style="list-style-type: none"> Gray Terminal width 6.2 mm  IEC 60947-7-1 <ul style="list-style-type: none"> Rigid 0.08 ... 6 mm², flexible 0.08 ... 4 mm², AWG 28 ... 10 I = 16 A, U = 400 V Enclosed at both ends 	8WH2000-6CG00		1 50 units 1BT		
Accessories						
 8WH9070-0AA00	Compartment partitions, for terminal sizes 1.5 ... 4 mm² Versions <ul style="list-style-type: none"> Two clamping points Three clamping points Four clamping points 	8WH9070-0AA00 8WH9070-0GA00 8WH9070-0HA00		100 50 units 1BT 100 50 units 1BT 100 50 units 1BT		
 8WH9000-2GA00	Covers, for terminal sizes 1.5 ... 2.5 mm² Versions <ul style="list-style-type: none"> For two clamping points For three clamping points For four clamping points 	8WH9000-2GA00 8WH9000-4GA00 8WH9000-5GA00		100 50 units 1BT 100 50 units 1BT 100 50 units 1BT		
 8WH9000-0GA00	Cover segments, for terminal size 2.5 mm² and three or four clamping points	8WH9000-0GA00		100 10 units 1BT		

For general accessories for 8WH terminal blocks, see [page 14/135](#).

Terminal Blocks

8WH2 Spring-Loaded Terminals

8WH isolating terminals

Overview

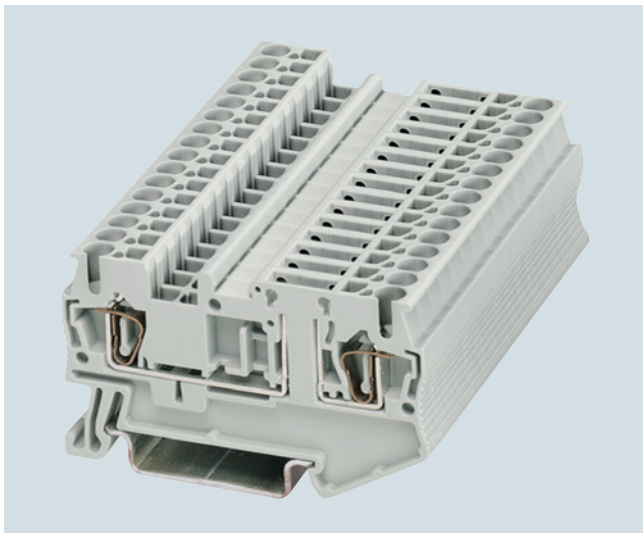

The isolating terminals are available with the same contour as the isolating blade terminals. The terminals excel with their narrow width of only 5.2 mm and their high current load rating of 16 A.

There is a test option for 2.3 mm \varnothing test plugs at both ends of the isolating point.

The 6.2 mm wide isolating terminal with terminal size 4 mm² is a base terminal for accommodating:

- Isolating plugs,
- Through-type connectors,
- Fused connectors and
- Component connectors.





A label can be snapped on to the middle of the terminal at the front. Further labels can also be mounted flat on the side of the terminals.

The isolating element must not be replaced under load.

Technical specifications

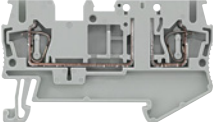
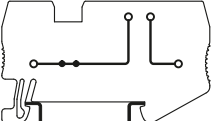
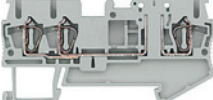
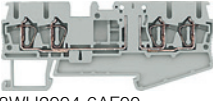
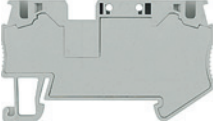
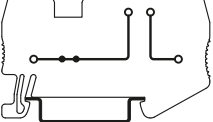
	8WH2000-6AF00	8WH2500-6AF00	8WH2003-6AF00	8WH2004-6AF00	8WH2000-6AG00
Dimensions					
• Width/length/cover width in mm	5.2 / 60.5 / 2.2	5.2 / 51 / 2.2	5.2 / 72 / 2.2	5.5 / 84 / 2.2	6.2 / 61.5 / --
• Height (NS 35/7.5 / NS 35/15) in mm	36.5 / 44	43 / 50.5	36.5 / 44		
Technical specifications acc. to IEC/DIN VDE					
• Max. load current in A / cross-section in mm ²	16 / 4				16 / 6
• Rated impulse withstand voltage in kV / pollution degree	6 / 3				
• Overvoltage category / molded plastic group	III / I				
Connection capacities					
• Flexible with end sleeve, with plastic sleeve in mm ²	0.25 ... 2.5				0.25 ... 4
• Flexible with end sleeve, without plastic sleeve in mm ²	0.25 ... 2.5				0.25 ... 4
• Flexible with two-wire connection end sleeve, with plastic sleeve in mm ²	0.5				
Stripped length in mm	10				
Plug gauge (IEC 60947-1)	A3				A4
Molded plastic type	PA				
• Flammability Class acc. to UL 94	V0				
Approval data (UL/cUL and CSA)					
• Rated voltage / rated current / conductor sizes					
- UL/cUL: in V/A / AWG	300 / 16 / 26 ... 12	300 / 16 / 24 ... 12	300 / 16 / 26 ... 12		300 / 6.3 / 24 ... 10
- CSA: in V/A / AWG	--				

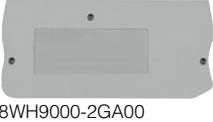
Selection and ordering data

Version	SD	Article No. www.siemens.com/ product?Article No.	Price per PU	PU (UNIT, SET, M)	PS	PG
d						
Terminal size 2.5 mm²						
 <p>8WH2000-6AF00</p>  <p>I201_12682 8WH2000-6AF00</p>  <p>8WH2003-6AF00</p>  <p>8WH2004-6AF00</p>		Isolating terminals, terminal size 2.5 mm² <ul style="list-style-type: none"> • Gray • Terminal width 5.2 mm • C_{UL} US • IEC 60947-7-1 <ul style="list-style-type: none"> - Rigid 0.08 ... 4 mm² - Flexible 0.08 ... 2.5 mm² - AWG 28 ... 12 - Current and voltage are determined by the fitted plug - $I = 16$ A - $U = 400$ V Versions <ul style="list-style-type: none"> • Two clamping points • Three clamping points • Four clamping points 				
		8WH2000-6AF00 8WH2003-6AF00 8WH2004-6AF00		1 50 units 1BT 1 50 units 1BT 1 50 units 1BT		
Terminal size 4 mm²						
 <p>8WH2000-6AG00</p>  <p>I201_12682 8WH2000-6AG00</p>		Isolating terminals, terminal size 4 mm², two clamping points <ul style="list-style-type: none"> • Gray • Terminal width 6.2 mm • C_{UL} US • IEC 60947-7-1 <ul style="list-style-type: none"> - Rigid 0.08 ... 6 mm² - Flexible 0.08 ... 4 mm² - AWG 28 ... 10 - Current and voltage are determined by the fitted plug - $I = 16$ A - $U = 400$ V • Enclosed at both ends 				
		8WH2000-6AG00		1 50 units 1BT		
Accessories						
 <p>8WH9070-0GA00</p>		Compartment partitions Versions <ul style="list-style-type: none"> • For terminal size 2.5 mm² <ul style="list-style-type: none"> - For three clamping points - For four clamping points • For terminal size 4 mm² <ul style="list-style-type: none"> - For two clamping points 				
		8WH9070-0GA00 8WH9070-0HA00 8WH9070-0AA00		100 50 units 1BT 100 50 units 1BT 100 50 units 1BT		
 <p>8WH9000-2GA00</p>		Covers Gray Versions <ul style="list-style-type: none"> • For terminal sizes 1.5 ... 2.5 mm² and two clamping points • For terminal size 2.5 mm² and three clamping points • For terminal size 2.5 mm² and four clamping points 				
		8WH9000-2GA00 8WH9000-4GA00 8WH9000-5GA00		100 50 units 1BT 100 50 units 1BT 100 50 units 1BT		
 <p>8WH9000-0GA00</p>		Cover segments, for terminal sizes 1.5 and 2.5 mm² and three or four clamping points Gray				
		8WH9000-0GA00		100 10 units 1BT		

For general accessories for 8WH terminal blocks, see [page 14/135](#).

Terminal Blocks

8WH2 Spring-Loaded Terminals

8WH two-tier terminals

Overview

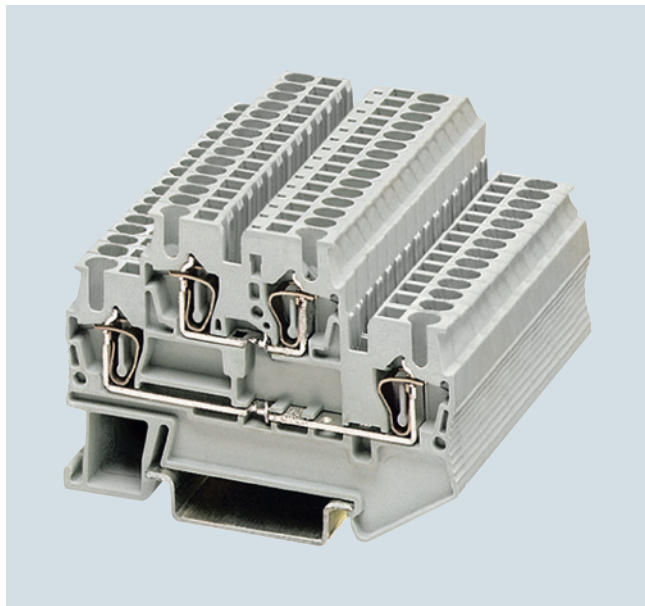

Standard two-tier terminals

With the two voltage levels routed through two separate tiers, the two-tier terminals require 50% less space than equivalent single-tier terminals. To implement a wide range of wiring tasks, connecting combs can be fitted to both tiers of the spring-loaded terminal series. Facilities for inscription are provided at each clamping point.

PE/ground conductor function

Perfect mechanical and electrical contact with the support rail is provided by simply snapping the terminals onto the rail.

The PE two-tier terminals meet all the requirements of IEC 60947-7-2:

- Low contact resistance
- Stainless clamping points
- Green-yellow enclosure
- Additional inscription options

PE/L and PE/N types

The PE/L and PE/N types provide a PE/ground contact to the support rail in the lower tier. The upper tier is designed as a through-type tier. Color coding of the PE and neutral tiers enables clear and unambiguous distribution of the potential.

The clamping points of two-tier terminals can be inscribed with flat labels.

Technical specifications

	8WH2020-0AE00 8WH2020-0AE01 8WH2025-0AE00	8WH0020-0CE07	8WH2020-0AF00 8WH2020-0AF01 8WH2025-0AF00	8WH2023-0AF00 8WH2023-0AF01 8WH2022-0AF00	8WH2020-0CF07
Dimensions					
• Width/length/cover width in mm	4.2 / 67.5 / 2.2		5.2 / 67.5 / 2.2	5.2 / 91.5 / 2.2	5.2 / 67.5 / 2.2
• Height (NS 35/7.5 / NS 35/15) in mm	47.5 / 55				
Technical specifications acc. to IEC/DIN VDE					
• Max. load current in A / cross-section in mm ²	17.5 / 1.5	--	26 / 4	--	--
• Maximum data / rated data in A / mm ²	--			26 / 4 or 22 / 2.5	--
• Rated impulse withstand voltage in kV / pollution degree	6 / 3				
• Overvoltage category / molded plastic group	III / I				
Connection capacities					
• Flexible with end sleeve, with plastic sleeve in mm ²	0.25 ... 1.5		0.25 ... 2.5		
• Flexible with end sleeve, without plastic sleeve in mm ²	0.25 ... 1.5		0.25 ... 2.5		
• Flexible with two-wire connection end sleeve, with plastic sleeve in mm ²	0.5				
Stripped length in mm	10				
Plug gauge (IEC 60947-1)	A1		A3		
Molded plastic type	PA				
• Flammability Class acc. to UL 94	V0				
Approval data (UL/cUL and CSA)					
• Rated voltage / rated current / conductor sizes					
- UL/cUL: in V/A / AWG	300 / 15 / 26 ... 14	-- / -- / 26 ... 14	600 / 20 / 26 ... 12	300 / 20 / 26 ... 12	-- / -- / 26 ... 12
- CSA: in V/A / AWG	300 / 15 / 26 ... 14	-- / -- / 26 ... 14	--	--	-- / -- / 26 ... 12
Support rails/protective conductor busbars	--	see page 14/3, section "Support rails"	--		see page 14/3, section "Support rails"

	8WH2023-0CF07
Dimensions	
• Width/length/cover width in mm	5.2 / 91.5 / 2.2
• Height (NS 35/7.5 / NS 35/15) in mm	47.5 / 55
Technical specifications acc. to IEC/DIN VDE	
• Max. load current in A / cross-section in mm ²	--
• Rated impulse withstand voltage in kV / pollution degree	6 / 3
• Overvoltage category / molded plastic group	III / I
Connection capacities	
• Flexible with end sleeve, with plastic sleeve in mm ²	0.25 ... 2.5
• Flexible with end sleeve, without plastic sleeve in mm ²	0.25 ... 2.5
• Flexible with two-wire connection end sleeve, with plastic sleeve in mm ²	0.5
Stripped length in mm	10
Plug gauge (IEC 60947-1)	A3
Molded plastic type	PA
• Flammability Class acc. to UL 94	V0
Approval data (UL/cUL and CSA)	
• Rated voltage / rated current / conductor sizes	
- UL/cUL: in V/A / AWG	-- / -- / 26 ... 12
- CSA: in V/A / AWG	-- / -- / 26 ... 12
Support rails/protective conductor busbars	see page 14/3, section "Support rails"







	8WH2020-4CF00	8WH2020-0AG00 8WH2020-0AG01 8WH2025-0AG00	8WH2020-0CG07
Dimensions			
• Width/length/cover width in mm	5.2 / 67.5 / 2.2	6.2 / 83.5 / 2.2	6.2 / 83.5 / 2.2
• Height (NS 35/7.5 / NS 35/15) in mm	47.5 / 55		
Technical specifications acc. to IEC/DIN VDE			
• Max. load current in A / cross-section in mm ²	26 / 4	32 / 6	--
• Rated impulse withstand voltage in kV / pollution degree	6 / 3		
• Overvoltage category / molded plastic group	III / I		
Connection capacities			
• Flexible with end sleeve, with plastic sleeve in mm ²	0.25 ... 2.5	0.25 ... 4	0.25 ... 4
• Flexible with end sleeve, without plastic sleeve in mm ²	0.25 ... 2.5	0.25 ... 4	0.25 ... 4
• Flexible with two-wire connection end sleeve, with plastic sleeve in mm ²	0.5	0.5 ... 1	0.5 ... 1
Stripped length in mm	10		
Plug gauge (IEC 60947-1)	A3	A4	
Molded plastic type	PA		
• Flammability Class acc. to UL 94	V0		
Approval data (UL/cUL and CSA)			
• Rated voltage / rated current / conductor sizes			
- UL/cUL: in AWG	300 / 20 / 26 ... 12	300 / 30 / 20 ... 10	20 ... 10
- CSA: in AWG	-- / -- / 26 ... 12		20 ... 10
Support rails/protective conductor busbars	--		see page 14/3, section "Support rails"

Terminal Blocks

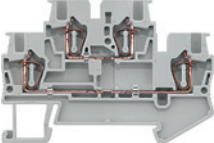
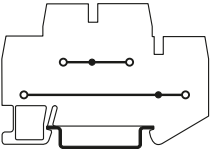
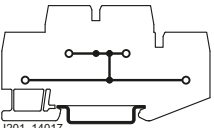
8WH2 Spring-Loaded Terminals

8WH two-tier terminals

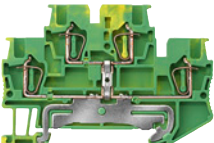
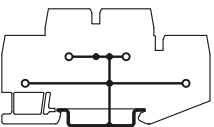
Selection and ordering data

Version	SD	Article No. www.siemens.com/ product?Article No.	Price per PU	PU (UNIT, SET, M)	PS	PG
d						
Terminal size 1.5 mm²						
 <p>8WH2020-0AE00</p>  <p>i201_12691 8WH2020-0AE00</p>  <p>i201_14017 8WH2025-0AE00</p>		<p>Two-tier terminals, terminal size 1.5 mm²</p> <ul style="list-style-type: none"> Terminal width 4.2 mm   IEC 60947-7-1 <ul style="list-style-type: none"> Rigid 0.08 ... 1.5 mm² Flexible 0.08 ... 1.5 mm² AWG 28 ... 16 I = 17.5 A The total current through all connected conductors must not exceed the max. load current U = 500 V <p>Versions</p> <ul style="list-style-type: none"> Gray <ul style="list-style-type: none"> Without equipotential bonding, 2-pole,  With equipotential bonding, 1-pole Blue, 2-pole 				
		<p>8WH2020-0AE00</p> <p>8WH2025-0AE00</p> <p>8WH2020-0AE01</p>			<p>1 50 units 1BT</p> <p>1 50 units 1BT</p> <p>1 50 units 1BT</p>	
 <p>8WH2020-0CE07</p>  <p>i201_12688 8WH2020-0CE07</p>		<p>PE two-tier terminals, terminal size 1.5 mm²</p> <ul style="list-style-type: none"> Terminal width 4.2 mm   IEC 60947-7-1 <ul style="list-style-type: none"> Rigid 0.08 ... 1.5 mm² Flexible 0.08 ... 1.5 mm² AWG 28 ... 16 Green-yellow 				
		8WH2020-0CE07			1 50 units 1BT	

Terminal Blocks

8WH2 Spring-Loaded Terminals

8WH two-tier terminals

Version	SD	Article No. www.siemens.com/ product?Article No.	Price per PU	PU (UNIT, SET, M)	PS	PG
	d					

Terminal size 2.5 mm²

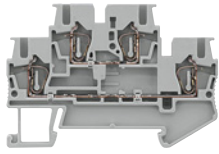

8WH2020-0AF00

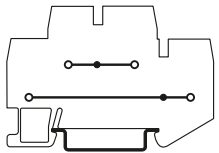
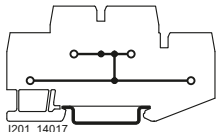
I201_12691
8WH2020-0AF00I201_14017
8WH2025-0AF00

Two-tier terminals, terminal size 2.5 mm²

- Terminal width 5.2 mm
-
- IEC 60947-7-1
 - Rigid 0.08 ... 4 mm²
 - Flexible 0.08 ... 2.5 mm²
 - AWG 28 ... 12
 - I = 26 A
 - The total current through all connected conductors must not exceed the max. load current
 - U = 500 V

Versions

- Gray
 - Without equipotential bonding, 2-pole
 - With equipotential bonding, 1-pole
- Blue
 - Without equipotential bonding, 2-pole
 - With equipotential bonding, 1-pole

8WH2020-0AF00
8WH2025-0AF00

1 50 units 1BT
1 50 units 1BT

8WH2020-0AF01
8WH2025-0AF01

1 50 units 1BT
1 50 units 1BT

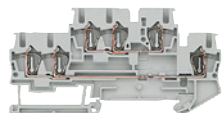

8WH2023-0AF00

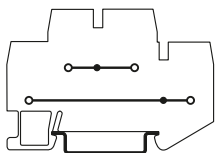
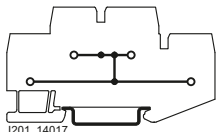
I201_12691
8WH2023-0AF00I201_14017
8WH2022-0AF00

Two-tier terminals, terminal size 2.5 mm², three clamping points on one level

- Terminal width 5.2 mm
-
- IEC 60947-7-1
 - Rigid 0.08 ... 4 mm²
 - Flexible 0.08 ... 2.5 mm²
 - AWG 28 ... 12
 - I = 26 A
 - The total current through all connected conductors must not exceed the max. load current
 - U = 500 V

Versions

- Gray
 - Without equipotential bonding, 2-pole
 - With equipotential bonding, 1-pole
- Blue, 2-pole

8WH2023-0AF00
8WH2022-0AF00
8WH2023-0AF01

1 50 units 1BT
1 50 units 1BT
1 50 units 1BT

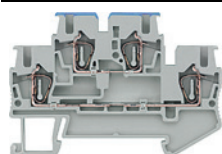

8WH2020-4CF00

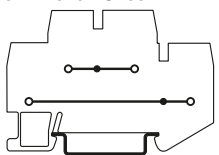
I201_12691
8WH2020-4CF00

Two-tier terminals, terminal size 2.5 mm², N at top and L at bottom

- Gray
- Terminal width 5.2 mm
-
- IEC 60947-7-1
 - Rigid 0.08 ... 4 mm²
 - Flexible 0.08 ... 2.5 mm²
 - AWG 28 ... 12
 - I = 26 A
 - U = 500 V









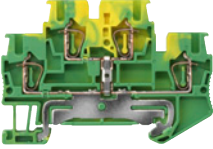
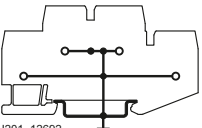

8WH2020-4CF00

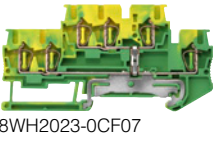
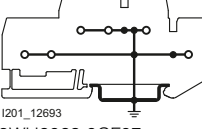
1 50 units 1BT

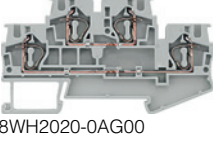
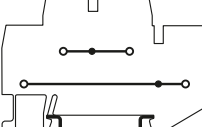
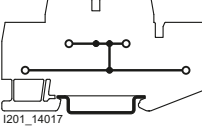
Terminal Blocks

8WH2 Spring-Loaded Terminals

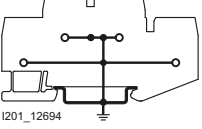

8WH two-tier terminals

Version	SD	Article No. www.siemens.com/ product?Article.No.	Price per PU	PU (UNIT, SET, M)	PS	PG
 <p>8WH2020-OCF07</p>  <p>1201_12692 8WH2020-OCF07</p>	d	PE two-tier terminals, terminal size 2.5 mm², two clamping points on one level	8WH2020-OCF07	1	50 units	1BT
		<ul style="list-style-type: none"> Terminal width 5.2 mm •   US • IEC 60947-7-2 <ul style="list-style-type: none"> - Rigid 0.08 ... 4 mm² - Flexible 0.08 ... 2.5 mm² - AWG 28 ... 12 • Green-yellow 				
 <p>8WH2023-OCF07</p>  <p>1201_12693 8WH2023-OCF07</p>		PE two-tier terminals, terminal size 2.5 mm², three clamping points on one level	8WH2023-OCF07	1	50 units	1BT
		<ul style="list-style-type: none"> Terminal width 5.2 mm •   US • IEC 60947-7-2 <ul style="list-style-type: none"> - Rigid 0.08 ... 4 mm² - Flexible 0.08 ... 2.5 mm² - AWG 28 ... 12 • Green-yellow 				
Terminal size 4 mm²						
 <p>8WH2020-0AG00</p>  <p>1201_12691 8WH2020-0AG00</p>  <p>1201_14017 8WH2025-0AG00</p>		Two-tier terminals, terminal size 4 mm² <ul style="list-style-type: none"> Terminal width 6.2 mm •   US • IEC 60947-7-1 <ul style="list-style-type: none"> - Rigid 0.08 ... 6 mm² - Flexible 0.08 ... 4 mm² - AWG 28 ... 10 - $I = 32$ A - The total current through all connected conductors must not exceed the max. load current - $U = 500$ V 	8WH2020-0AG00	1	50 units	1BT
		Versions <ul style="list-style-type: none"> • Gray <ul style="list-style-type: none"> - Without equipotential bonding, 2-pole - With equipotential bonding, 1-pole • Blue, 2-pole 	8WH2025-0AG00	1	50 units	1BT
			8WH2020-0AG01	1	50 units	1BT
 <p>8WH2020-0CG07</p>  <p>1201_12694 8WH2020-0CG07</p>		PE two-tier terminals, terminal size 4 mm² <ul style="list-style-type: none"> Terminal width 6.2 mm •   US • IEC 60947-7-2 <ul style="list-style-type: none"> - Rigid 0.08 ... 6 mm² - Flexible 0.08 ... 4 mm² - AWG 28 ... 10 • Green-yellow 	8WH2020-0CG07	1	50 units	1BT

Terminal Blocks

8WH2 Spring-Loaded Terminals

8WH two-tier terminals

Version	SD	Article No. www.siemens.com/ product?Article No.	Price per PU	PU (UNIT, SET, M)	PS	PG
d						
Accessories						
		Compartment partitions, for terminal sizes 1.5 ... 4 mm² <ul style="list-style-type: none"> • For visual and electrical separation of terminal groups • 2 mm thick 		8WH9070-0BA00	100 50 units	1BT
8WH9070-0BA00						
		Covers Gray Versions				
		<ul style="list-style-type: none"> • For terminal sizes 1.5 ... 2.5 mm² • For terminal size 2.5 mm² and three clamping points • For terminal size 4 mm² 		8WH9000-1VA00 8WH9000-2VA00 8WH9003-1VA00	100 50 units 100 50 units 100 50 units	1BT 1BT 1BT
8WH9000-1VA00						

For general accessories for 8WH terminal blocks, see [page 14/135](#).

Terminal Blocks

8WH2 Spring-Loaded Terminals

8WH three-tier terminals

Overview

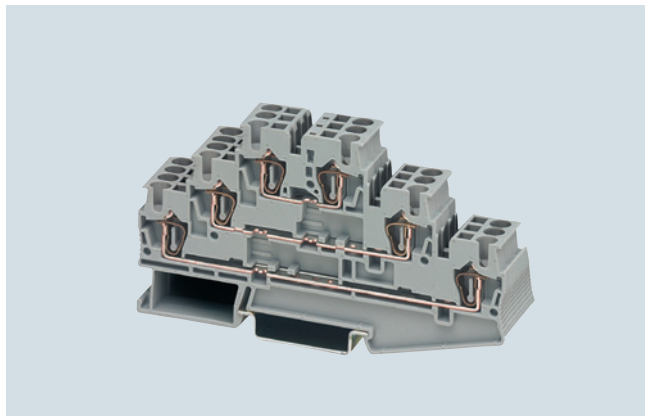

Our three-tier terminals offer three feed-through levels in a slim 5.2 mm terminal enclosure. They enable high wiring density – ideal for switchboards where space is at a premium.

With one bridge shaft per tier, these terminal blocks are ideal for use as compact potential distributors or initiator terminals. All six clamping points are interconnected on the equipotential bonding versions.

The three-tier terminal range is rounded off with a PE terminal with the same contour.

Inscription

Each tier of three-tier terminals can be inscribed with flat labels. If a label holder is used, the labels can be inserted at the front.

Benefits

- Three feed-through levels with minimum footprint
- Comprehensive range of inscription options
- Matching accessories for 8WH terminal range
- One bridge shaft per tier
- Label holder is inserted

Technical specifications

	8WH2030-0AF00 8WH2030-0AF01 8WH2035-0AF00 8WH2035-0AF01	8WH2035-OCF07	8WH2030-4EF00 8WH2030-4HF00
Dimensions			
• Width / length in mm	5,2 / 99,5	5,2 / 99,5	5,2 / 99,5
• Height (TS 35/7.5 / TS 35/15 / TS 32) in mm	58 / 65,5	58 / 65,5	58 / 65,5
Technical specifications acc. to IEC/DIN VDE			
• Max. load current in A / cross-section in mm ²	28 / 4	--	28 / 4
• Rated impulse withstand voltage in kV / pollution degree	6 / 3	6 / 3	6 / 3
• Overvoltage category / molded plastic group	III / 1	III / 1	III / 1
Connection capacities			
• Flexible with end sleeve, with/without plastic sleeve in mm ²	0.25 ... 2.5	0.25 ... 2.5	0.25 ... 2.5
• Flexible with end sleeve, without plastic sleeve in mm ²	0.25 ... 2.5	0.25 ... 2.5	0.25 ... 2.5
• Flexible with TWIN end sleeve, with plastic sleeve in mm ²	0.5	0.5	0.5
Stripped length in mm	10	10	10
Plug gauge (IEC 60947-1)	A3	A3	A3
Molded plastic type	PA	PA	PA
• Flammability Class acc. to UL 94	V0	V0	V0
Approval data (UL/CUR and CSA)			
• Rated voltage / rated current / conductor sizes			
- UL/CUR: V/A/AWG	600 / 20 / 26 ... 12	-- / -- / 24 ... 12	300 / 20 / 26 ... 12
- CSA: V/A/AWG	--	--	--

Selection and ordering data

Version	SD	Article No. www.siemens.com/ product?Article No.	Price per PU	PU (UNIT, SET, M)	PS	PG
	d					

Terminal size 2.5 mm²

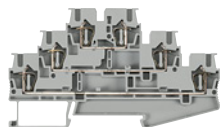

8WH2030-0AF00

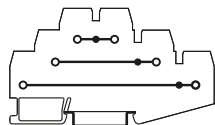

I201_13974

8WH2030-0AF00

Three-tier terminals, terminal size 2.5 mm²

- Terminal width 5.2 mm
- US
- IEC 60947-7-1
 - Rigid 0.08 ... 4 mm²
 - Flexible 0.08 ... 2.5 mm²
 - AWG 28 ... 12
 - I = 28 A
 - U = 500 V

Versions

- Gray
- Blue









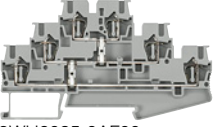
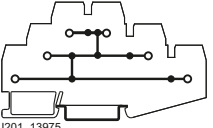

8WH2030-0AF00
8WH2030-0AF01

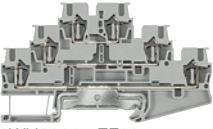
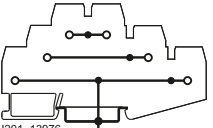
1 50 units 1BT
1 50 units 1BT

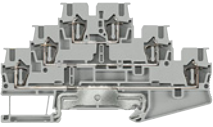
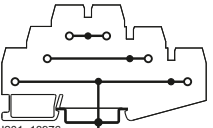
Terminal Blocks

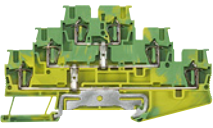
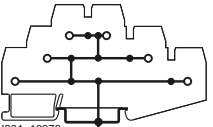
8WH2 Spring-Loaded Terminals

8WH three-tier terminals

Version	SD	Article No. www.siemens.com/ product?Article.No.	Price per PU	PU (UNIT, SET, M)	PS	PG
 <p>8WH2035-0AF00</p>  <p>1201_13975 8WH2035-0AF00</p> <p>Three-tier terminals, with equipotential bonding, terminal size 2.5 mm²</p> <ul style="list-style-type: none"> Terminal width 5.2 mm •  US • IEC 60947-7-1 <ul style="list-style-type: none"> - Rigid 0.08 ... 4 mm² - Flexible 0.08 ... 2.5 mm² - AWG 28 ... 12 - I = 28 A - U = 500 V <p>Versions</p> <ul style="list-style-type: none"> • Gray • Blue <p>Note</p> <p>The total current through all connected conductors must not exceed the maximum load current.</p>	d					
 <p>8WH2030-4EF00</p>  <p>1201_13976 8WH2030-4EF00</p> <p>Three-tier terminals, "PE/L/N", terminal size 2.5 mm²</p> <ul style="list-style-type: none"> Terminal width 5.2 mm •  US • IEC 60947-7-1 + IEC 60947-7-2 <ul style="list-style-type: none"> - Rigid 0.08 ... 4 mm² - Flexible 0.08 ... 2.5 mm² - AWG 28 ... 12 		8WH2030-4EF00		1	50 units	1BT
 <p>8WH2030-4HF00</p>  <p>1201_13976 8WH2030-4HF00</p> <p>Three-tier terminals, "PE/L/L", terminal size 2.5 mm²</p> <ul style="list-style-type: none"> Terminal width 5.2 mm •  US • IEC 60947-7-1 + IEC 60947-7-2 <ul style="list-style-type: none"> - Rigid 0.08 ... 4 mm² - Flexible 0.08 ... 2.5 mm² - AWG 28 ... 12 - I = 28 A - U = 500 V 		8WH2030-4HF00		1	50 units	1BT
 <p>8WH2035-0CF07</p>  <p>1201_13978 8WH2035-0CF07</p> <p>PE three-tier terminals, terminal size 2.5 mm²</p> <ul style="list-style-type: none"> Terminal width 5.2 mm •  US • IEC 60947-7-2 <ul style="list-style-type: none"> - Rigid 0.08 ... 4 mm² - Flexible 0.08 ... 2.5 mm² - AWG 28 ... 12 		8WH2035-0CF07		1	50 units	1BT
Accessories						
 <p>8WH9000-1GD00</p> <p>Covers, for three-tier terminals</p>		8WH9000-1GD00		100	50 units	1BT
 <p>8WH9060-4BA00</p> <p>Label holders, for three-tier terminals</p>		8WH9060-4BA00		100	100 units	1BT

For general accessories for 8WH terminal blocks, see page 14/135.

Minimum order quantity (PS) or a multiple thereof can be ordered.

Terminal Blocks

8WH2 Spring-Loaded Terminals

8WH four-tier motor terminals

Overview

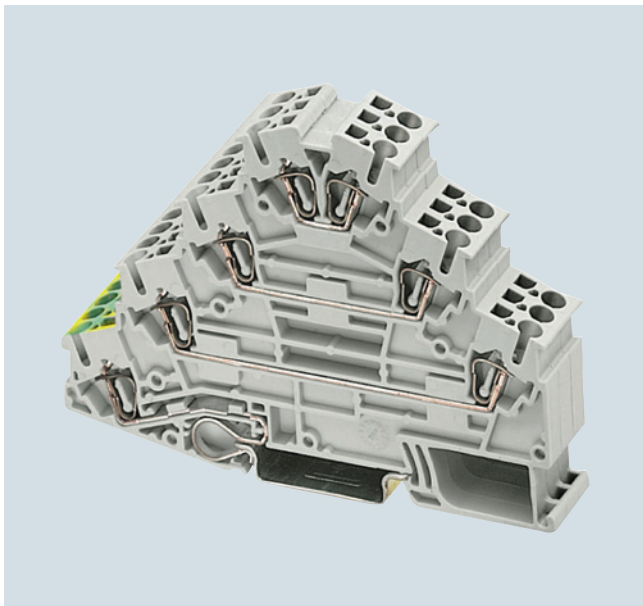

Terminal size 2.5 mm²

The four-tier motor terminals with terminal size 2.5 mm² are ideal for the compact wiring of AC loads. They have three through-levels and one PE connection which is contacted by simply snapping it onto the mounting rail.

No cross-bridging option.

Terminal size 4 mm²

Like the 2.5 mm² version, the four-tier motor terminal with 4 mm² terminal size also allows the wiring of three phases and the PE in a single terminal. This terminal is enclosed at both ends.

No cross-bridging option.

Integrated PE/ground conductor function

PE contact with the support rail is made by simply snapping the terminal onto the rail. This makes the four-tier motor terminals with terminal size 4 mm² ideal for the space-saving wiring of AC motors.

Inscription

Each clamping point has a facility for inscription and a test option for 2.3 mm \varnothing test plugs.





There is also sufficient space for labeling in the middle of the terminal on the front.

Labels can be mounted flat at the side of the terminals by simply snapping on.

Technical specifications

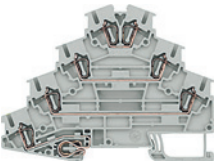
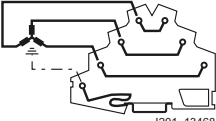
	8WH2040-4LF00	8WH2040-4LG00
Dimensions		
• Width/length/cover width in mm	5.2 / 98.5 / 2.2	6.2 / 101 / --
• Height (NS 35/7.5 / NS 35/15) in mm	73.5 / 81	83.5 / 91
Technical specifications acc. to IEC/DIN VDE		
• Max. load current in A / cross-section in mm ²	26 / 4	32 / 6
• Rated impulse withstand voltage in kV / pollution degree	8 / 3	
• Overvoltage category / molded plastic group	III / I	
Connection capacities		
• Flexible with end sleeve, with plastic sleeve in mm ²	0.25 ... 2.5	0.25 ... 4
• Flexible with end sleeve, without plastic sleeve in mm ²	0.25 ... 2.5	0.25 ... 4
• Flexible with two-wire connection end sleeve, with plastic sleeve in mm ²	--	0.5 ... 1
Stripped length in mm	10	
Plug gauge (IEC 60947-1)	A3	A4
Molded plastic type	PA	
• Flammability Class acc. to UL 94	V0	
Approval data (UL/cUL and CSA)		
• Rated voltage / rated current / conductor sizes		
- UL/cUL: in V/A / AWG	-- / -- / 26 ... 12	--
- CSA: in V/A / AWG	--	600 / 30 / 28-10

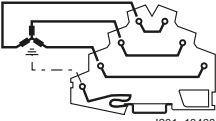
Selection and ordering data

Version	SD	Article No. www.siemens.com/ product?Article No.	Price per PU	PU (UNIT, SET, M)	PS	PG
d						
Terminal size 2.5 mm²						
 <p>8WH2040-4LF00</p>  <p>8WH2040-4LF00 I201_13468</p>		Four-tier motor terminals, terminal size 2.5 mm² <ul style="list-style-type: none"> Terminal width 5.2 mm  US IEC 60947-7-1 and IEC 60947-7-2 <ul style="list-style-type: none"> Rigid 0.08 ... 4 mm² Flexible 0.08 ... 2.5 mm² AWG 28 ... 12 I = 26 A U = 800 V 				
Terminal size 4 mm²						
 <p>8WH2040-4LG00</p>  <p>8WH2040-4LG00 I201_13468</p>		Four-tier motor terminals, terminal size 4 mm² <ul style="list-style-type: none"> Terminal width 6.2 mm  US IEC 60947-7-1 and IEC 60947-7-2 <ul style="list-style-type: none"> Rigid 0.08 ... 6 mm² Flexible 0.08 ... 4 mm² AWG 28 ... 10 I = 32 A U = 800 V Enclosed at both ends 				
Accessories						
 <p>8WH9000-1GE00</p>		Covers For four-tier motor terminals, terminal size 2.5 mm²				
For general accessories for 8WH terminal blocks, see page 14/135 .						

Terminal Blocks

8WH2 Spring-Loaded Terminals

8WH diode terminals

Overview

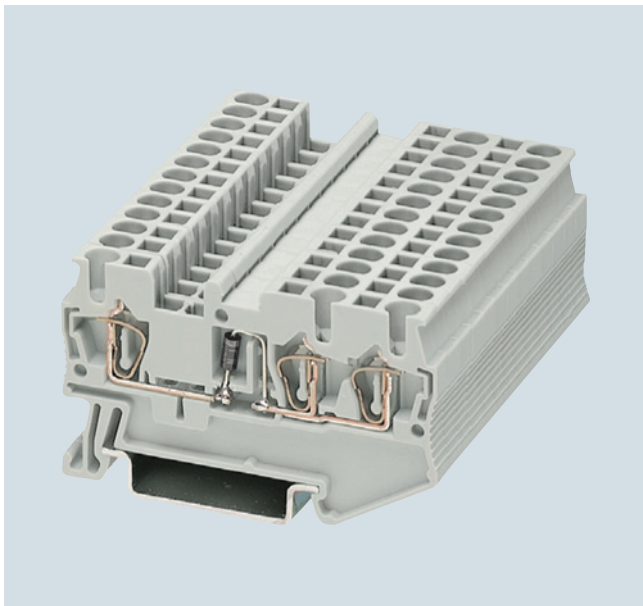





Diode terminals with a nominal cross-section of 2.5 mm^2 and a mounting width of just 5.2 mm can be used to implement many different wiring tasks. The diode is soldered in from left to right or vice versa as required.

A label can be snapped on to the middle of each terminal at the front. Further labels can also be mounted flat on the side of the terminals.

Technical specifications

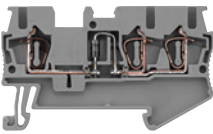
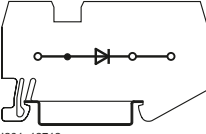
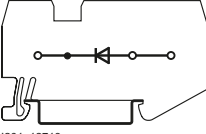
	8WH2003-5DF00 8WH2003-5CF00
Dimensions	
• Width/length/cover width in mm	5.5 / 60.5 / 2.2
• Height HV-M... (NS 35/7.5 / NS 35/15) in mm	36.5 / 44
Technical specifications acc. to IEC/DIN VDE	
• Max. load current in A / cross-section in mm^2	Determined by the diode / 4
• Rated impulse withstand voltage in kV / pollution degree	4 / 3
• Overvoltage category / molded plastic group	III / 1
Connection capacities	
• Flexible with end sleeve, with plastic sleeve in mm^2	0.25 ... 2.5
• Flexible with end sleeve, without plastic sleeve in mm^2	0.25 ... 2.5
• Flexible with two-wire connection end sleeve, with plastic sleeve in mm^2	0.5
Stripped length in mm	10
Plug gauge (IEC 60947-1)	A3
Molded plastic type	PA
• Flammability Class acc. to UL 94	V0
Approval data (UL/cUL and CSA)	
• Rated voltage / rated current / conductor sizes	
- UL/cUL: V / A / AWG	600 / 20 / 26 ... 12
- CSA: V / A / AWG	--

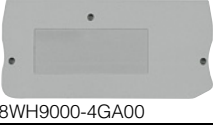
Selection and ordering data

Version	SD	Article No. www.siemens.com/ product?Article No.	Price per PU	PU (UNIT, SET, M)	PS	PG
Terminal size 2.5 mm²						
 <p>8WH2003-5DF00</p>  <p>I201_12712 8WH2003-5DF00</p>  <p>I201_12713 8WH2003-5CF00</p>		Diode terminals, terminal size 2.5 mm², with three clamping points <ul style="list-style-type: none"> • Uninterrupted limiting current: 0.5 A • Blocking voltage: 1300 V • Terminal width 5.2 mm •  us • Connection data <ul style="list-style-type: none"> - Rigid 0.08 ... 4 mm² - Flexible 0.08 ... 2.5 mm² - AWG 28 ... 12 - I = the maximum current is determined by the diode - U = 500 V • With integrated diode • Integrated: Diode 1N 4007 Versions <ul style="list-style-type: none"> • Let-through from left to right • Let-through from right to left 				
		8WH2003-5DF00 8WH2003-5CF00			1 50 units 1 50 units	1BT 1BT
Accessories						
 <p>8WH9070-0GA00</p>		Compartment partitions, for terminal sizes 1.5 ... 4 mm² and three clamping points			100 50 units	1BT
 <p>8WH9000-4GA00</p>		Covers, for terminal sizes 1.5 ... 2.5 mm² and three clamping points			100 50 units	1BT
 <p>8WH9000-0GA00</p>		Cover segments, for terminal sizes 1.5 and 2.5 mm² and three clamping points			100 10 units	1BT

For general accessories for 8WH terminal blocks, see [page 14/135](#).

Terminal Blocks

8WH2 Spring-Loaded Terminals

8WH two-tier diode terminals

Overview

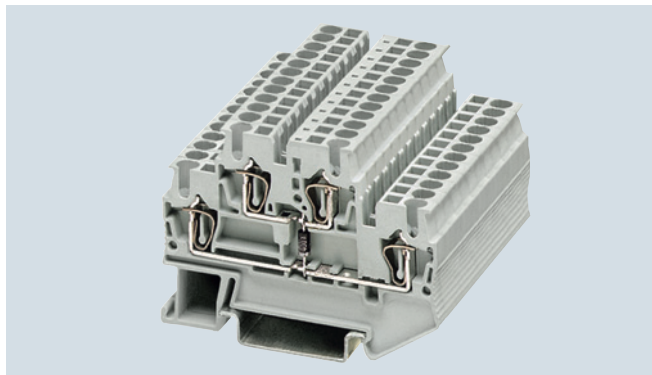

Two-tier diode terminals can be used together with different versions to implement many different wiring tasks.

The following circuits are possible in the tightest spaces:

- Freewheel diode circuits
- Lamp test circuits
- Signaling and fault signaling circuits

The clamping points of two-tier terminals can be inscribed with flat labels.

Technical specifications

	8WH2020-5AF00, 8WH2020-5DF00	8WH2020-5KF00	8WH2020-5JF30
Dimensions			
• Width/length/cover width in mm	5.2 / 67.5 / 2.2		
• Height (NS 35/7.5 / NS 35/15) in mm	47.5 / 55		
Technical specifications acc. to IEC/DIN VDE			
• Max. load current in A (not via diodes) / cross-section in mm ²	26 / 4		
• Rated impulse withstand voltage in kV / pollution degree	4 / 3		
• Overvoltage category / molded plastic group	III / I		
Connection capacities			
• Flexible with end sleeve, with plastic sleeve in mm ²	0.25 ... 2.5		
• Flexible with end sleeve, without plastic sleeve in mm ²	0.25 ... 2.5		
• Flexible with two-wire connection end sleeve, with plastic sleeve in mm ²	0.5		
Stripped length in mm	10		
Plug gauge (IEC 60947-1)	A3		
Molded plastic type	PA		
• Flammability Class acc. to UL 94	V0		
Approval data (UL/cUL and CSA)			
• Rated voltage / rated current / conductor sizes			
- UL/cUL: in V/A / AWG	300 / 20 / 26 ... 12		
- CSA: in V/A / AWG	300 / 20 / 26 ... 12		

Selection and ordering data

Version	SD	Article No. www.siemens.com/ product?Article No.	Price per PU	PU (UNIT, SET, M)	PS	PG
	d					

General details

UL Approved

Terminal size 2.5 mm²

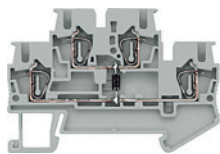

8WH2020-5AF00

Two-tier terminals, terminal size 2.5 mm², with one diode



- Terminal width 5.2 mm
- Connection data
 - Rigid 0.08 ... 4 mm², flexible 0.08 ... 2.5 mm², AWG 28 ... 12
 - $I = 26$ A, $U = 500$ V
- Maximum current determined by diode
- Integrated: Diode 1N 4007
 - Blocking voltage: 1300 V, uninterrupted limiting current: 0.5 A

Circuit diagram	Version				
	Let-through from top to bottom	8WH2020-5AF00	1	50 units	1BT
	Let-through from bottom left to bottom right	8WH2020-5DF00	1	50 units	1BT

Terminal Blocks

8WH2 Spring-Loaded Terminals

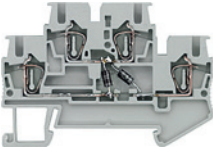
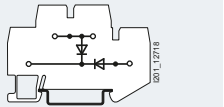
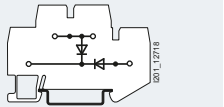
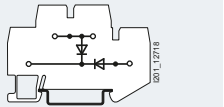
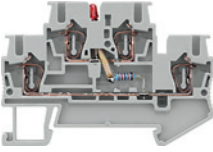
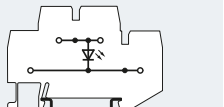
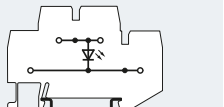
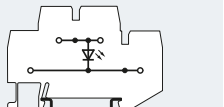
8WH two-tier diode terminals

Version	SD	Article No. www.siemens.com/ product?Article No.	Price per PU	PU (UNIT, SET, M)	PS	PG				
 <p>Two-tier diode terminals, terminal size 2.5 mm², with two diodes</p> <ul style="list-style-type: none"> Terminal width 5.2 mm Connection data <ul style="list-style-type: none"> Rigid 0.08 ... 4 mm² Flexible 0.08 ... 2.5 mm² AWG 28 ... 12 $I = 26 \text{ A}$, $U = 500 \text{ V}$ Maximum current determined by diode Integrated: Diode 1N 4007 <ul style="list-style-type: none"> Blocking voltage: 1300 V Uninterrupted limiting current: 0.5 A 	d									
<table border="1"> <thead> <tr> <th>Circuit diagram</th> <th>Version</th> </tr> </thead> <tbody> <tr> <td></td> <td>Let-through from top to bottom left and from bottom right to bottom left</td> </tr> </tbody> </table>	Circuit diagram	Version		Let-through from top to bottom left and from bottom right to bottom left		8WH2020-5KF00		1	50 units	1BT
Circuit diagram	Version									
	Let-through from top to bottom left and from bottom right to bottom left									
 <p>Two-tier diode terminals, terminal size 2.5 mm², with illuminated display</p> <ul style="list-style-type: none"> Terminal width 5.2 mm Connection data <ul style="list-style-type: none"> Rigid 0.08 ... 4 mm² Flexible 0.08 ... 2.5 mm² AWG 28 ... 12 $I = 26 \text{ A}$ $U = 500 \text{ V}$ 										
<table border="1"> <thead> <tr> <th>Circuit diagram</th> <th>Version</th> </tr> </thead> <tbody> <tr> <td></td> <td>15 ... 30 V DC / 2.5 ... 7.5 A</td> </tr> </tbody> </table>	Circuit diagram	Version		15 ... 30 V DC / 2.5 ... 7.5 A		8WH2020-5JF30		1	50 units	1BT
Circuit diagram	Version									
	15 ... 30 V DC / 2.5 ... 7.5 A									
Accessories										
 <p>Compartment partitions, for terminal sizes 1.5 ... 4 mm²</p>		8WH9070-0BA00		100	50 units	1BT				
 <p>Covers, for terminal sizes 1.5 and 2.5 mm²</p>		8WH9000-1VA00		100	50 units	1BT				

For general accessories for 8WH terminal blocks, see [page 14/135](#).

Terminal Blocks

8WH5 Combination Plug-In Terminals

Introduction

Overview

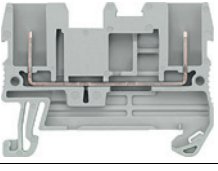
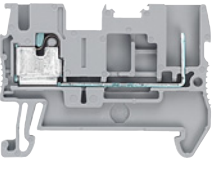
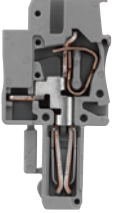
	Devices	Page	Function
	8WH5 through-type terminals	14/87	Terminals for the connection of combination plug-in terminals
	8WH5 hybrid through-type terminals with iPo connection	14/89	Terminals for the connection of combination plug-in terminals
	8WH9 plugs	14/90	For connection of combination plugs for fast wiring

Features

Conductor cross-section	Terminal type	Color	Combination plugs		Article No. (digits 8 ... 12)
			8WH5000	8WH5004	
2.5 mm ²	Through-type	Gray	✓	✓	0AF00
		Blue	✓	✓	0AF01
	PE	Green-yellow	✓	✓	OCF07

Benefits

High-performance contact



The advanced plug-in system of the combination plug-in terminals enables plug-in wiring up to a rated current of 24 A and a rated voltage of 800 V. The contact system withstands extreme vibration thanks to the integral overspring.

Fingerproof design

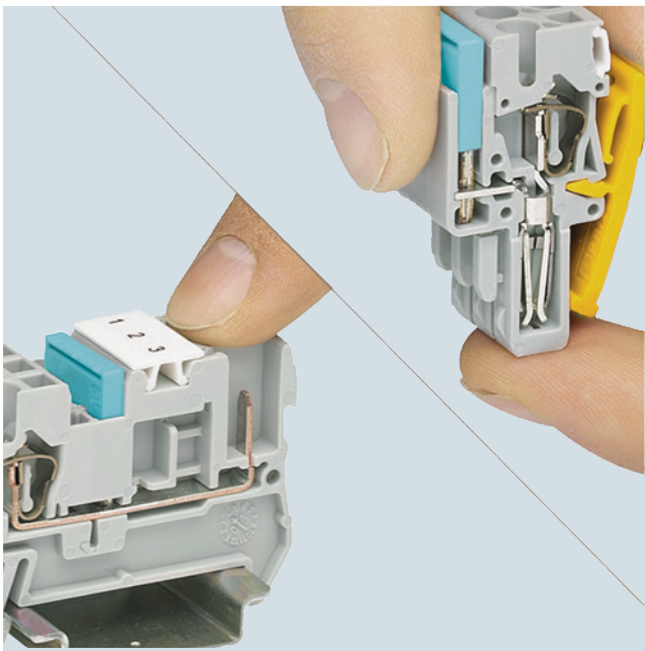

With its fingerproof base terminals and plugs, the combination plug-in terminal system provides maximum user protection. As well as enhancing safety, this provides exceptional flexibility during configuration: the power can be supplied either through the terminals or the plugs.

Time and cost-saving potential distribution

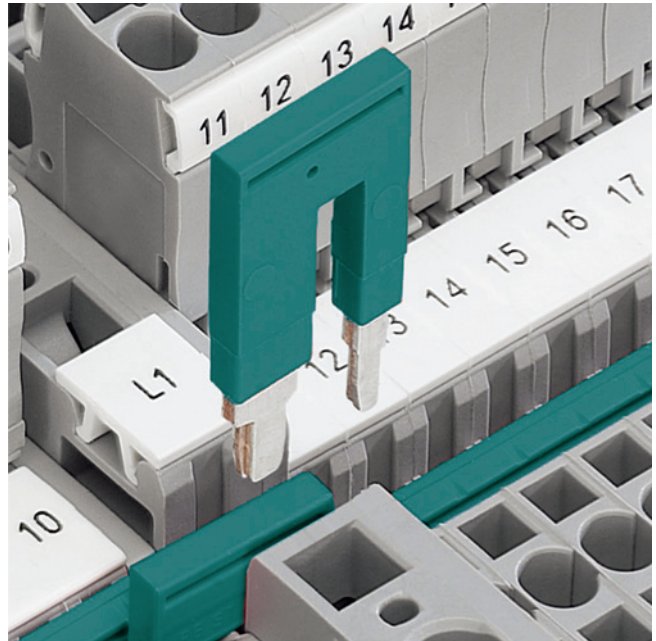

When feeding in large cross-sections, the reducing comb enables time and cost-saving distribution of the potential. For example, it can link a 10 mm² through-type terminal to a 2.5 mm² through-type terminal and two clamping points.

Standardized connecting comb system

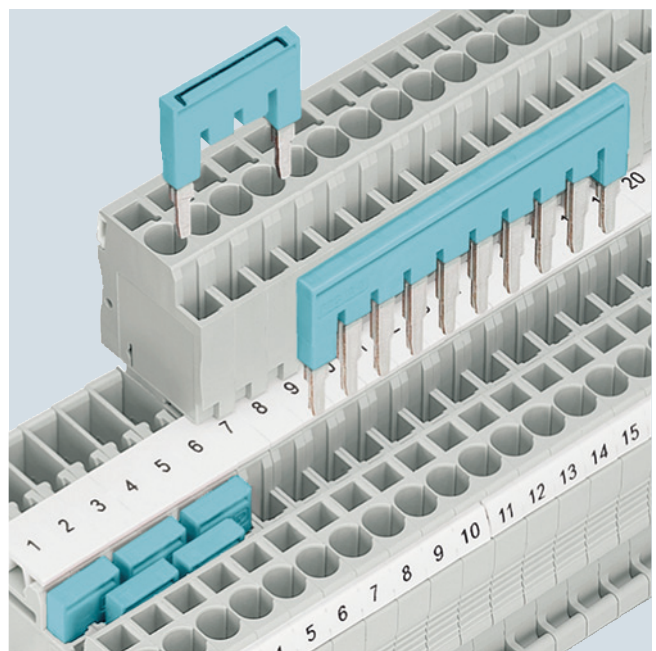

The standardized connecting comb system allows up to 50 terminals to be connected efficiently and quickly with a single jumper. Teeth can be removed to skip individual terminals.

Terminal Blocks

8WH5 Combination Plug-In Terminals

Introduction

Universal plug-in zone

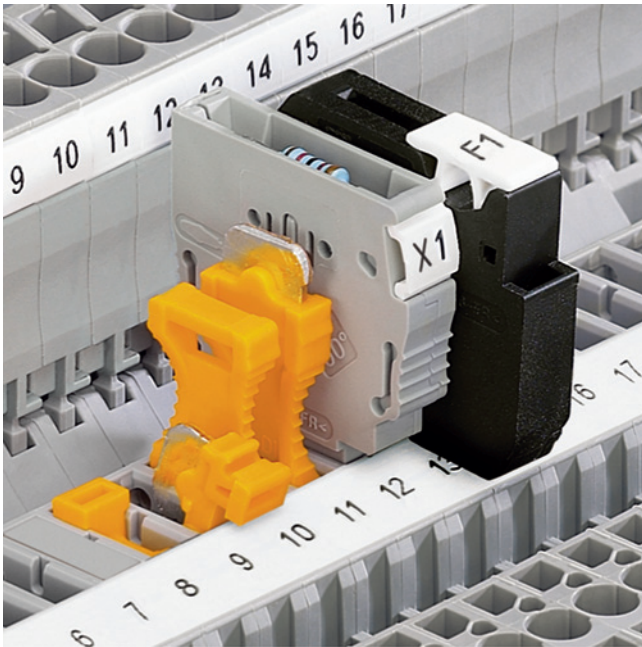

The universal plug-in zone of the isolating terminal can accommodate isolated through-type connectors, isolating plugs, component connectors and fused connectors.

The isolating element must not be replaced under load.

Assembling test adapters

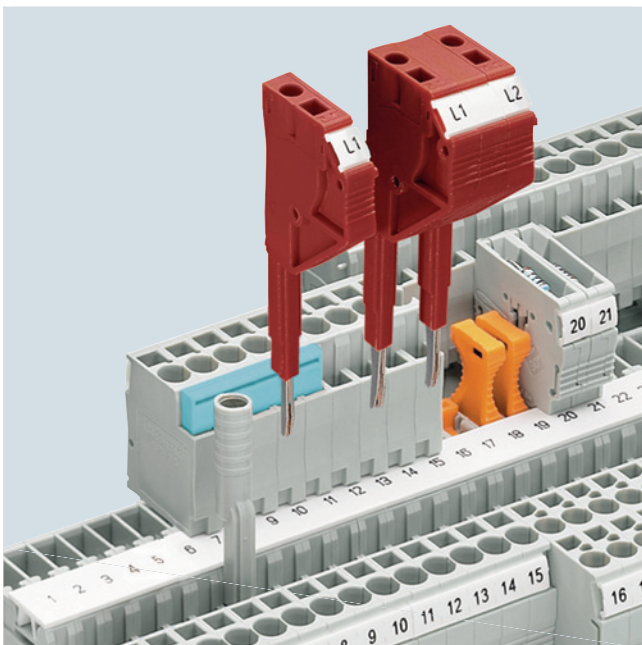

Test adapters are available for $\varnothing 4$ mm test and safety test plugs. Test plugs can be individually assembled, thanks to the modular design of the test plugs. Measuring leads can be connected over a 1.5 mm^2 spring-loaded terminal.

Coding the combination plug-in terminals

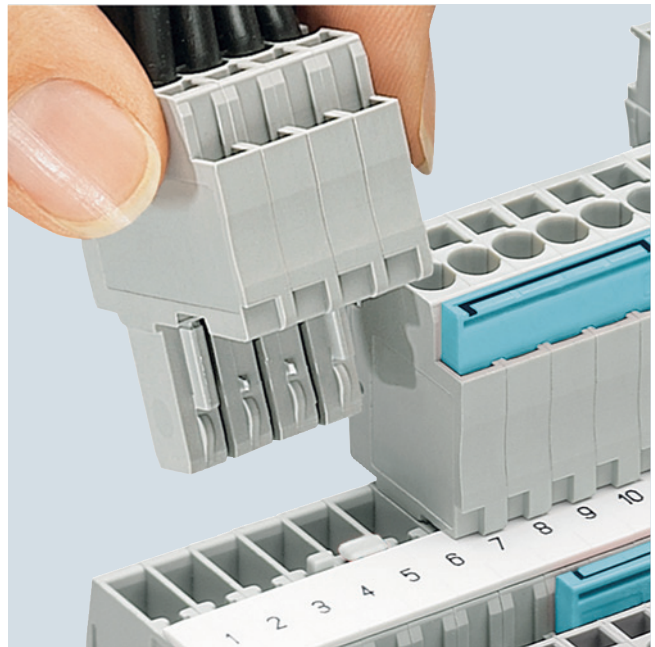

The combination plug-in terminals can be coded with the pin on the plug. The pin is simply removed from the plug, rotated and fitted in the coding position of the base terminal.

Snap-on strain relief

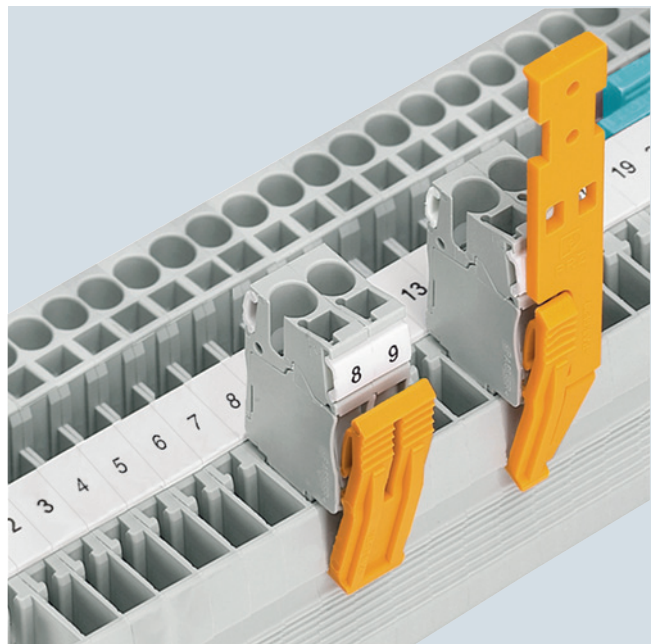

Snap-on clamps are available to relieve cable strain at the plugs. Latches are also available to secure the plugs firmly to the base terminals.

Overview

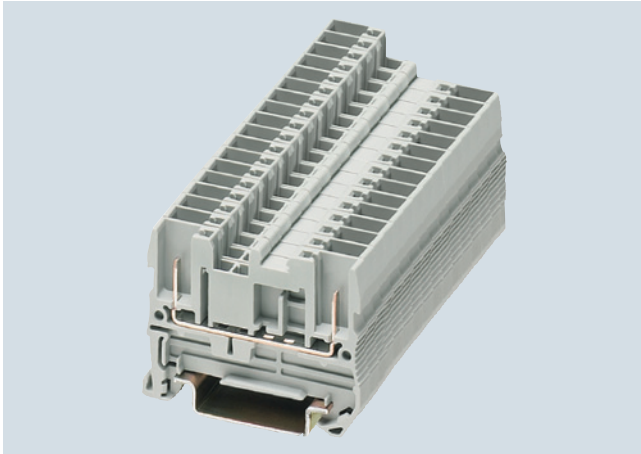

Plugs can be connected at both ends of the terminal using the through-type terminals of the combination plug-in terminals. This makes the combination plug-in terminal system even more flexible and allows the terminals to be used as connecting elements between modules.

The plugs used have a terminal size of 2.5 mm², thus enabling continued use of familiar accessories, such as latches, strain relief and shield connectors.

PE terminals with the same contour are available for the base terminals. These are simply snapped onto the support rail to establish a connection to ground potential.

A label can be snapped on to the middle of each terminal at the front. Further labels can also be mounted flat on the side of the terminals.

Technical specifications

	8WH5000-0AF00, 8WH5000-0AF01	8WH5000-0CF07
Dimensions		
• Width/length/cover width in mm	5.2 / 48.5 / 2.2	5.2 / 48.5 / 2.2
• Height (TS 35/7.5 / TS 35/15) in mm	36.5 / 44	36.5 / 44
Technical specifications acc. to IEC/DIN VDE		
• Max. load current in A ¹⁾ / cross-section in mm ²	24 / 4	--
• Rated impulse withstand voltage in kV / pollution degree	6 / 3	
• Overvoltage category / molded plastic group	III / I	
Connection capacities		
• Flexible with end sleeve, with plastic sleeve in mm ²	0.25 ... 2.5	
• Flexible with end sleeve, without plastic sleeve in mm ²	0.25 ... 2.5	
• Flexible with two-wire connection end sleeve, with plastic sleeve in mm ²	0.5	
Molded plastic type	PA	
• Flammability Class acc. to UL 94	V0	
Approval data (UL/cUL and CSA)		
• Rated voltage / rated current / conductor sizes		
- UL/cUL: in V/A / AWG	300 / 20 / --	-- / -- / -- see page 14/90, section 8WH9 plugs
- CSA: in V/A / AWG	--	
Support rails/protective conductor busbars	--	see page 14/3, section "Support rails"

1) Derating of the load current is necessary for higher temperatures and/or multi-pole combination plug versions.

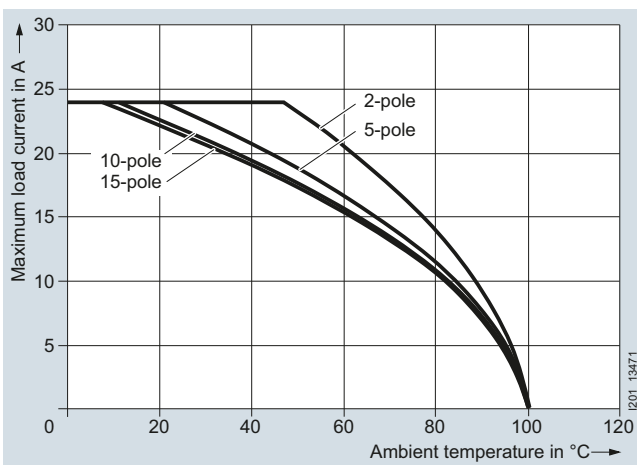



Derating curve for 8WH5000-0AF00

Terminal Blocks

8WH5 Combination Plug-In Terminals

8WH5 through-type terminals

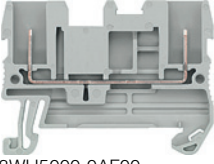
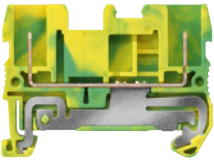
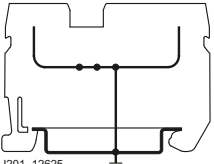
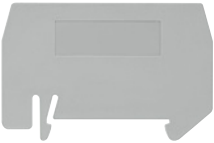
Selection and ordering data

Version	SD	Article No. www.siemens.com/ product?Article No.	Price per PU	PU (UNIT, SET, M)	PS	PG
d						
Terminal size 2.5 mm²						
 <p>8WH5000-0AF00</p>	Through-type terminals, terminal size 2.5 mm² <ul style="list-style-type: none"> Terminal width 5.2 mm CU IEC 61984 <ul style="list-style-type: none"> - I = 24 A - U = 500 V 		8WH5000-0AF00 8WH5000-0AF01	1 50 units 1BT 1 50 units 1BT		
	Versions <ul style="list-style-type: none"> Gray <ul style="list-style-type: none"> - Two clamping points Blue <ul style="list-style-type: none"> - Two clamping points 					
Note On the terminal with four clamping points, the total current through all connected conductors must not exceed the max. load current.						
 <p>8WH5000-0CF07</p>	PE through-type terminals, terminal size 2.5 mm² <ul style="list-style-type: none"> Green-yellow Terminal width 5.2 mm CU IEC 61984 		8WH5000-0CF07	1 50 units 1BT		
	Versions <ul style="list-style-type: none"> Two clamping points 					
 <p>1201_12625 8WH5000-0CF07</p>						
Accessories						
 <p>8WH9070-0AA00</p>	Compartment partitions, for terminal sizes 1.5 ... 4 mm² <ul style="list-style-type: none"> For visual and electrical separation of terminal groups 2 mm thick 		8WH9070-0AA00	100 50 units 1BT		
	Versions <ul style="list-style-type: none"> For two clamping points 					
 <p>8WH9000-1GA00</p>	Covers, for terminal size 2.5 mm² Gray		8WH9000-1GA00	100 50 units 1BT		
	Versions <ul style="list-style-type: none"> Two clamping points 					

For general accessories for 8WH terminal blocks, see [page 14/135](#).

Terminal Blocks

8WH5 Combination Plug-In Terminals

8WH5 hybrid through-type terminal with iPo connection

Overview

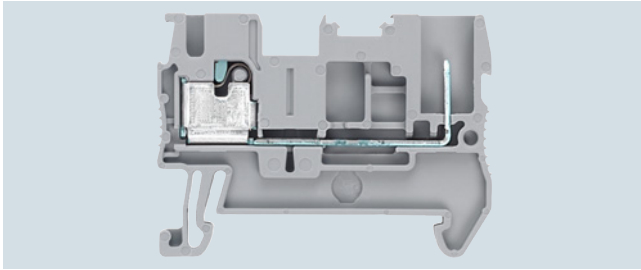

The 8WH5 hybrid through-type terminals with iPo connection provide a modular solution for fast, flexible wiring of plants and machines. They combine the advantages of the combination terminal system with those of the iPo terminals.





A label can be snapped on to the middle of each terminal at the front. Further labels can also be mounted flat on the side of the terminals.

Technical specifications

	8WH5100-2PF00	8WH5100-3PF07
Dimensions		
• Width/length/cover width in mm	5.2 / 48.5 / 2.2	
• Height (TS 35/7.5 / TS 35/15) in mm	36.5	
Technical specifications acc. to IEC/DIN VDE		
• Max. load current in A ¹⁾ / cross-section in mm ²	24	--
• Rated impulse withstand voltage in kV / pollution degree	500	--
Connection capacity, 1 conductor		
• Rigid	0.14 ... 2.5	
• Flexible with end sleeve with/without plastic sleeve in mm ²	0.14 ... 2.5	
Molded plastic type		
• Flammability Class acc. to UL 94	V0	
Approval data (UL/cUL and CSA)		
• Rated voltage / rated current / conductor sizes		
- UL/cUL: in V/A / AWG	500 / 300 / 26 ... 12	
- CSA: in V/A / AWG	-- / --	
Support rails/protective conductor busbars	--	see page 14/3, section "Support rails"

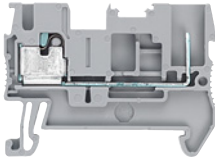
¹⁾ Derating of the load current is necessary for higher temperatures and/or multi-pole combination plug versions.

Selection and ordering data

Version	SD	Article No. www.siemens.com/ product?Article No.	Price per PU	PU (UNIT, SET, M)	PS	PG
Hybrid through-type terminals with iPo connection, terminal size 2.5 mm²						
 8WH5100-2PF00		Hybrid through-type terminals, terminal size 2.5 mm² <ul style="list-style-type: none">• Gray• Terminal width 5.2 mm• Rated current / cross section $I_n = 24 \text{ A} / 2.5 \text{ mm}^2$• Rated voltage $U_n = 500 \text{ V}$• Rigid 0.14 ... 4 mm²• Flexible with end sleeve 0.14 ... 2.5 mm²• Stripped length 10 mm			1 50 units	1BT
 8WH5100-3PF07		Hybrid PE through-type terminals, terminal size 2.5 mm² <ul style="list-style-type: none">• Green-yellow• Terminal width 5.2 mm• Rigid 0.14 ... 4 mm²• Flexible with end sleeve 0.14 ... 2.5 mm²• Connection type: plug-in spring-loaded connection• Stripped length 10 mm			1 50 units	1BT
Accessories						
 8WH9070-0HA00		Compartment partitions For terminal sizes 1.5 ... 4 mm ² and four clamping points			100 50 units	1BT
 8WH9000-1GA00		Covers For terminal size 2.5 mm ² and two clamping points			100 50 units	1BT

For general accessories for 8WH terminal blocks, see page 14/135.

Minimum order quantity (PS) or a multiple thereof can be ordered.

Terminal Blocks

8WH5 Combination Plug-In Terminals

8WH9 plugs

Overview

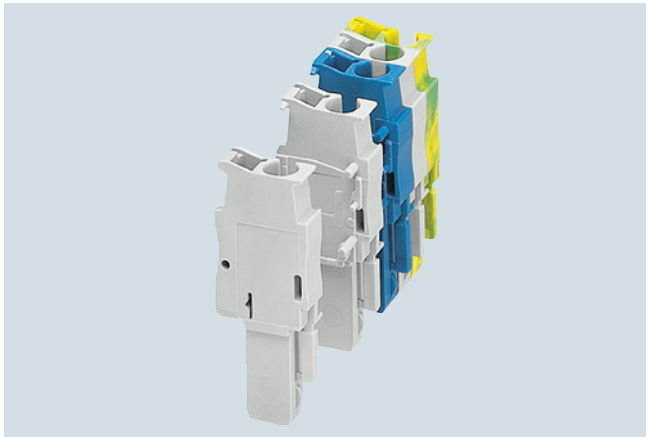

Assembled by the user in-situ from single-pole plug elements, the combination plug-in terminals in kit form provide a customized solution for every task.

For the existing plugs with terminal sizes 2.5 mm², and the plug with comb connection and terminal size 2.5 mm², single-pole basic versions in the colors gray, blue and green-yellow are available.

A left element at the beginning of the plug and a right element at the end are needed for each multi-pole plug. The number of middle elements depends on the plug's required number of poles. The individual elements are simply pushed together and latched with securing pins. Pliers may be needed to push them together. The right-hand component has an integrated cover, which covers the plug block. Labels enable flat inscription of the plugs.

Design

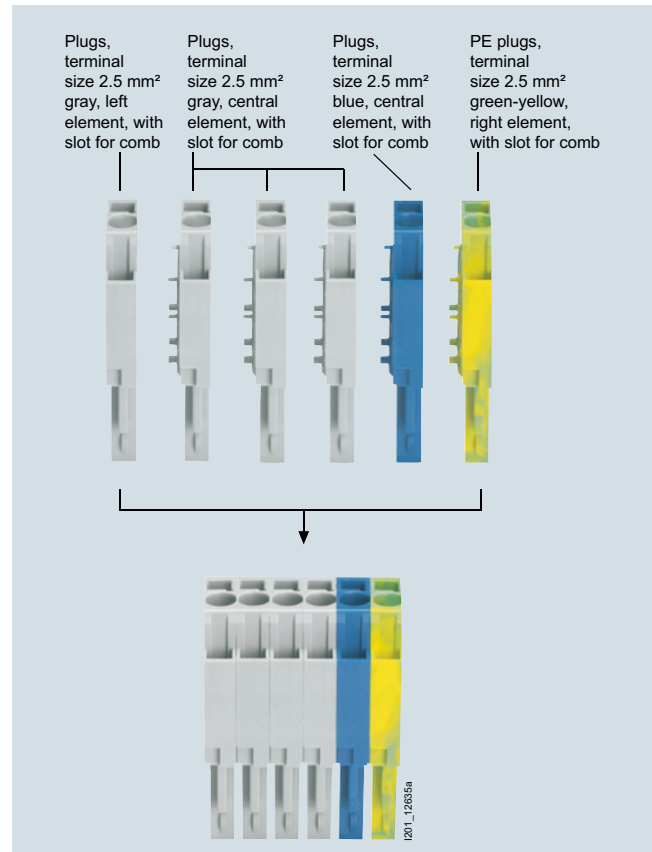





Example of a 6-pole plug

Technical specifications

	8WH9040-1AB00 8WH9040-1AB01 8WH9040-1BB00 8WH9040-1BB01 8WH9040-1CB00 8WH9040-1CB01 8WH9040-1DB00 8WH9040-1DB01 8WH9040-1EB00 8WH9040-1EB01 8WH9040-1FB00 8WH9040-1FB01	8WH9040-1AB07 8WH9040-1BB07 8WH9040-1CB07 8WH9040-1DB07 8WH9040-1EB07 8WH9040-1FB07	8WH9050-1KB00 8WH9050-1KB01 8WH9050-1LB00 8WH9050-1LB01 8WH9050-1MB00 8WH9050-1MB01	8WH9050-1KB07 8WH9050-1LB07 8WH9050-1MB07
Dimensions	--			
• Width/length/cover width in mm	--			
• Height (TS 35/7.5 / TS 35/15) in mm	--			
Technical specifications acc. to IEC/DIN VDE				
• Max. load current in A ¹⁾ / cross-section in mm ²	24 / 4		32 / 6	
• Rated impulse withstand voltage in kV / pollution degree	6 / 3		8 / 3	
• Overvoltage category / molded plastic group	III / I			
Connection capacities				
• Flexible with end sleeve, with plastic sleeve in mm ²	0.25 ... 2.5		0.25 ... 4	
• Flexible with end sleeve, without plastic sleeve in mm ²	0.25 ... 2.5		0.25 ... 4	
• Flexible with two-wire connection end sleeve, with plastic sleeve in mm ²	0.5		0.5 ... 1	
Stripped length	10			
Plug gauge (IEC 60947-1)	A3		A4	
Molded plastic type	PA			
• Flammability Class acc. to UL 94	V0			
Approval data (UL/cUL and CSA)				
• Rated voltage / rated current / conductor sizes	600 / 20 / 26 ... 12		Applied for	
- UL/cUL: in V/A / AWG	--		Applied for	
- CSA: in V/A / AWG	--		Applied for	
Support rails/protective conductor busbars	--		see page 14/3, section "Support rails"	

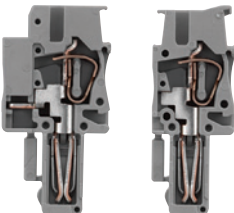
¹⁾ Derating of the load current is necessary for higher temperatures and/or multi-pole combination plug versions.

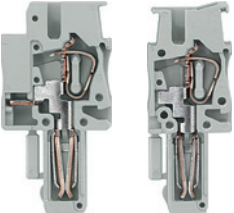
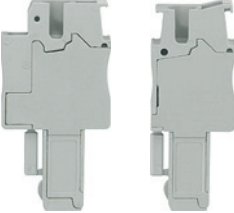

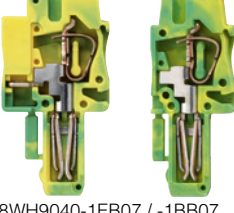
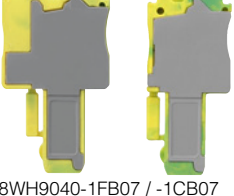
Selection and ordering data

Version	SD	Article No. www.siemens.com/ product?Article No.	Price per PU	PU (UNIT, SET, M)	PS	PG																																																																																															
d																																																																																																					
Terminal size 2.5 mm²																																																																																																					
																																																																																																					
Plugs, terminal size 2.5 mm² <ul style="list-style-type: none"> Terminal width 5.2 mm  Connection data <ul style="list-style-type: none"> Rigid 0.08 ... 4 mm² Flexible 0.08 ... 2.5 mm² AWG 28 ... 12 I = 24 A U = 500 V Number of poles = 1 																																																																																																					
8WH9040-1DB00 / -1AB00																																																																																																					
																																																																																																					
8WH9040-1EB00 / -1BB00																																																																																																					
																																																																																																					
8WH9040-1FB00 / -1CB00																																																																																																					
PE plugs, terminal size 2.5 mm² <ul style="list-style-type: none"> Green-yellow Terminal width 5.2 mm  Connection data <ul style="list-style-type: none"> Rigid 0.08 ... 4 mm² Flexible 0.08 ... 2.5 mm² AWG 28 ... 12 I = 24 A U = 500 V Number of poles = 1 																																																																																																					
8WH9040-1DB07 / -1AB07																																																																																																					
																																																																																																					
8WH9040-1EB07 / -1BB07																																																																																																					
																																																																																																					
8WH9040-1FB07 / -1CB07																																																																																																					
<table border="1"> <thead> <tr> <th>Article No.</th> <th>Price per PU</th> <th>PU (UNIT, SET, M)</th> <th>PS</th> <th>PG</th> </tr> </thead> <tbody> <tr> <td>8WH9040-1DB00</td> <td></td> <td>1</td> <td>50 units</td> <td>1BT</td> </tr> <tr> <td>8WH9040-1EB00</td> <td></td> <td>1</td> <td>50 units</td> <td>1BT</td> </tr> <tr> <td>8WH9040-1FB00</td> <td></td> <td>1</td> <td>50 units</td> <td>1BT</td> </tr> <tr> <td>8WH9040-1AB00</td> <td></td> <td>1</td> <td>50 units</td> <td>1BT</td> </tr> <tr> <td>8WH9040-1BB00</td> <td></td> <td>1</td> <td>50 units</td> <td>1BT</td> </tr> <tr> <td>8WH9040-1CB00</td> <td></td> <td>1</td> <td>50 units</td> <td>1BT</td> </tr> <tr> <td>8WH9040-1DB01</td> <td></td> <td>1</td> <td>50 units</td> <td>1BT</td> </tr> <tr> <td>8WH9040-1EB01</td> <td></td> <td>1</td> <td>50 units</td> <td>1BT</td> </tr> <tr> <td>8WH9040-1FB01</td> <td></td> <td>1</td> <td>50 units</td> <td>1BT</td> </tr> <tr> <td>8WH9040-1AB01</td> <td></td> <td>1</td> <td>50 units</td> <td>1BT</td> </tr> <tr> <td>8WH9040-1BB01</td> <td></td> <td>1</td> <td>50 units</td> <td>1BT</td> </tr> <tr> <td>8WH9040-1CB01</td> <td></td> <td>1</td> <td>50 units</td> <td>1BT</td> </tr> <tr> <td>8WH9040-1DB07</td> <td></td> <td>1</td> <td>50 units</td> <td>1BT</td> </tr> <tr> <td>8WH9040-1EB07</td> <td></td> <td>1</td> <td>50 units</td> <td>1BT</td> </tr> <tr> <td>8WH9040-1FB07</td> <td></td> <td>1</td> <td>50 units</td> <td>1BT</td> </tr> <tr> <td>8WH9040-1AB07</td> <td></td> <td>1</td> <td>50 units</td> <td>1BT</td> </tr> <tr> <td>8WH9040-1BB07</td> <td></td> <td>1</td> <td>50 units</td> <td>1BT</td> </tr> <tr> <td>8WH9040-1CB07</td> <td></td> <td>1</td> <td>50 units</td> <td>1BT</td> </tr> </tbody> </table>							Article No.	Price per PU	PU (UNIT, SET, M)	PS	PG	8WH9040-1DB00		1	50 units	1BT	8WH9040-1EB00		1	50 units	1BT	8WH9040-1FB00		1	50 units	1BT	8WH9040-1AB00		1	50 units	1BT	8WH9040-1BB00		1	50 units	1BT	8WH9040-1CB00		1	50 units	1BT	8WH9040-1DB01		1	50 units	1BT	8WH9040-1EB01		1	50 units	1BT	8WH9040-1FB01		1	50 units	1BT	8WH9040-1AB01		1	50 units	1BT	8WH9040-1BB01		1	50 units	1BT	8WH9040-1CB01		1	50 units	1BT	8WH9040-1DB07		1	50 units	1BT	8WH9040-1EB07		1	50 units	1BT	8WH9040-1FB07		1	50 units	1BT	8WH9040-1AB07		1	50 units	1BT	8WH9040-1BB07		1	50 units	1BT	8WH9040-1CB07		1	50 units	1BT
Article No.	Price per PU	PU (UNIT, SET, M)	PS	PG																																																																																																	
8WH9040-1DB00		1	50 units	1BT																																																																																																	
8WH9040-1EB00		1	50 units	1BT																																																																																																	
8WH9040-1FB00		1	50 units	1BT																																																																																																	
8WH9040-1AB00		1	50 units	1BT																																																																																																	
8WH9040-1BB00		1	50 units	1BT																																																																																																	
8WH9040-1CB00		1	50 units	1BT																																																																																																	
8WH9040-1DB01		1	50 units	1BT																																																																																																	
8WH9040-1EB01		1	50 units	1BT																																																																																																	
8WH9040-1FB01		1	50 units	1BT																																																																																																	
8WH9040-1AB01		1	50 units	1BT																																																																																																	
8WH9040-1BB01		1	50 units	1BT																																																																																																	
8WH9040-1CB01		1	50 units	1BT																																																																																																	
8WH9040-1DB07		1	50 units	1BT																																																																																																	
8WH9040-1EB07		1	50 units	1BT																																																																																																	
8WH9040-1FB07		1	50 units	1BT																																																																																																	
8WH9040-1AB07		1	50 units	1BT																																																																																																	
8WH9040-1BB07		1	50 units	1BT																																																																																																	
8WH9040-1CB07		1	50 units	1BT																																																																																																	

Terminal Blocks

8WH5 Combination Plug-In Terminals

8WH9 plugs

Version	SD	Article No. www.siemens.com/ product?Article No.	Price per PU	PU (UNIT, SET, M)	PS	PG
Accessories						
	Latches Number of poles: 2 Versions		8WH9050-2BA04 8WH9050-2AA04	100	50 units	1BT
	<ul style="list-style-type: none"> • With strain relief • Without strain relief 			100	50 units	1BT
	Shielding <ul style="list-style-type: none"> • For connection of shielded cables • For cables with 5 ... 10 mm diameter • Color: black 			1	50 units	1BT
	Shielding <ul style="list-style-type: none"> • For connection of shielded cables • For cables with 5 ... 10 mm diameter • Color: black 					
8WH9050-2BA04						
8WH9120-0DB08						

For general accessories for 8WH terminal blocks, [see page 14/135](#).

Overview

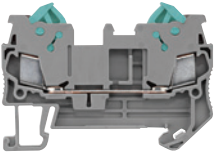
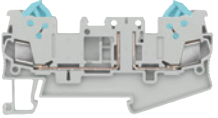
	Devices	Page	Function
	8WH through-type terminals	14/96	Connection up to 2.5 mm ² of incoming and outgoing conductors
	8WH isolating terminals	14/102	Isolation of the circuit, e.g. for test purposes

1) Only the main terminal types are listed here. You will find further versions on the following pages.

Features

Conductor cross-section	Terminal type ¹⁾	Color	Insulation displacement				Article No. (digits 8 ... 12)
			Connection type → Design →		Standard		
			No. of clamping points → 2	Article No. (digits 1 ... 7) →	3	4	
1.5 mm ²	Through-type	Gray	8WH3000	8WH3003	8WH3004	8WH3020	0AE00
		Blue	✓	✓	✓	✓	0AE01
	Isolating	Gray	✓	--	--	--	6AE00
		PE	Green-yellow	✓	✓	✓	✓
2.5 mm ²	Through-type	Gray	✓	✓	--	--	0AF00
		Blue	✓	✓	--	--	0AF01
	Isolating	Gray	✓	--	--	--	6AF00
		PE	Green-yellow	✓	--	--	--

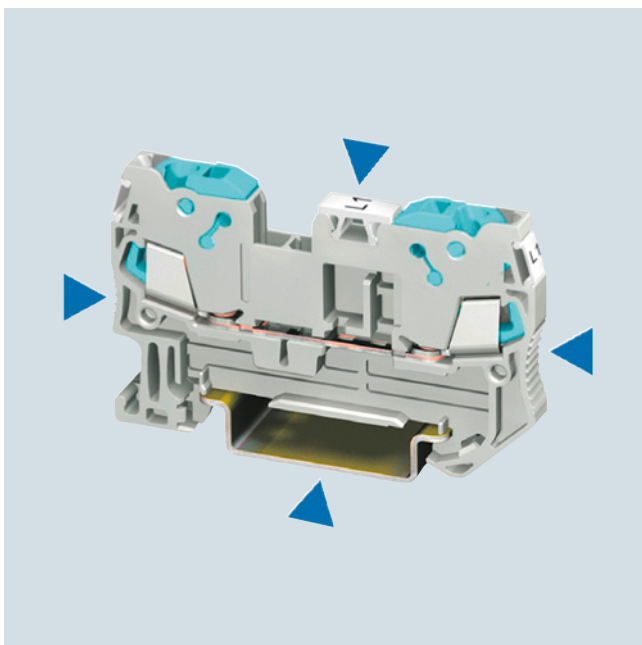

A key feature of the insulation displacement series is its IDC rotary connection. This concept saves considerable space in the control cabinet without impairing other quality features, such as

- Large surface marking
- Maximum connection compartment
- Flexible connecting combs



Time savings of 60% and more compared to other connection systems.

With the quick-connect insulation displacement terminal system, there is no need to strip the insulation or protect the splice. The cables only need to be cut to length for contacting within seconds.

Terminal Blocks

8WH3 Insulation Displacement Terminals

Introduction

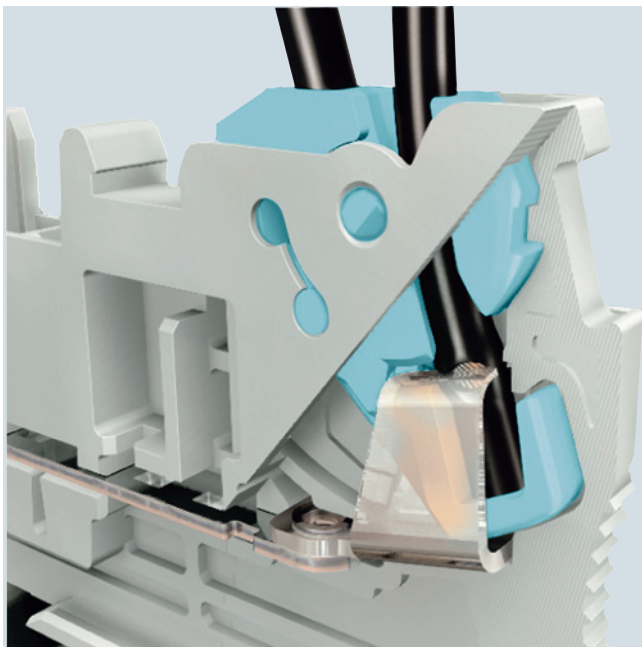

Conductor connections from 0.25 to 2.5 mm² are produced by the cutting contact. High-grade special alloys and latching of the switch states ensure reliable electrical connections at all times. Large, spring-loaded contact points ensure 24 A current load rating.

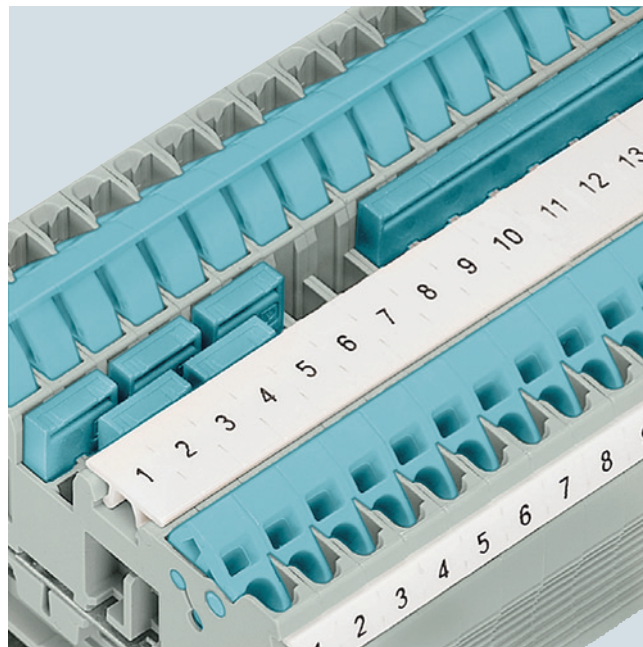

The standardized connecting comb system allows several terminals to be linked efficiently and quickly with a single jumper. The range covers 2 to 50-pole jumpers, which can help considerably to reduce the amount of wiring outlay.

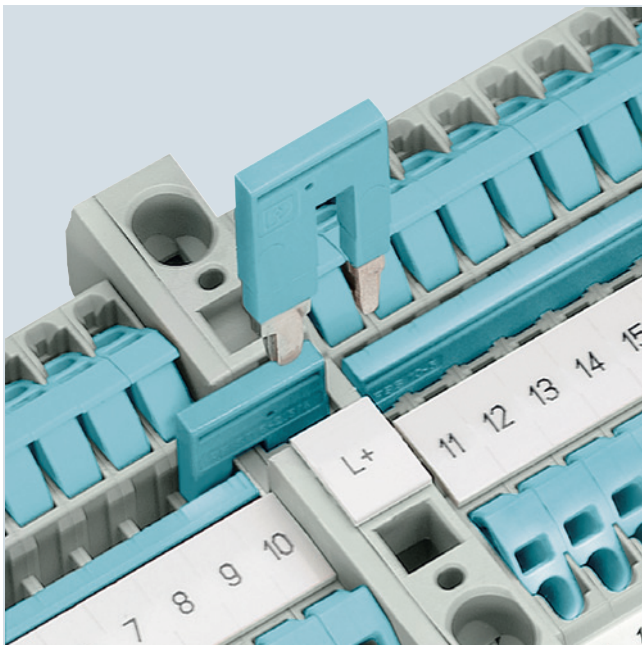

When feeding in large cross-sections, the reducing comb enables time and cost-saving distribution of the potential. For example, it can link a 10 mm² spring-loaded through-type terminal to a 1.5 mm² insulation displacement through-type terminal and two clamping points – or to a 2.5 mm² insulation displacement through-type terminal and two clamping points.

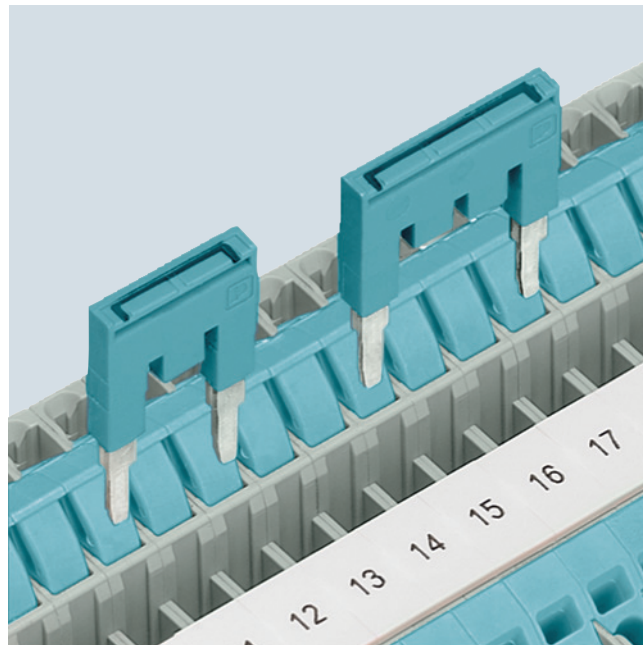

Teeth can be removed from the standard comb in order to skip individual terminals, so that two potentials can run in parallel. A marking option is provided on the top of the connecting comb.

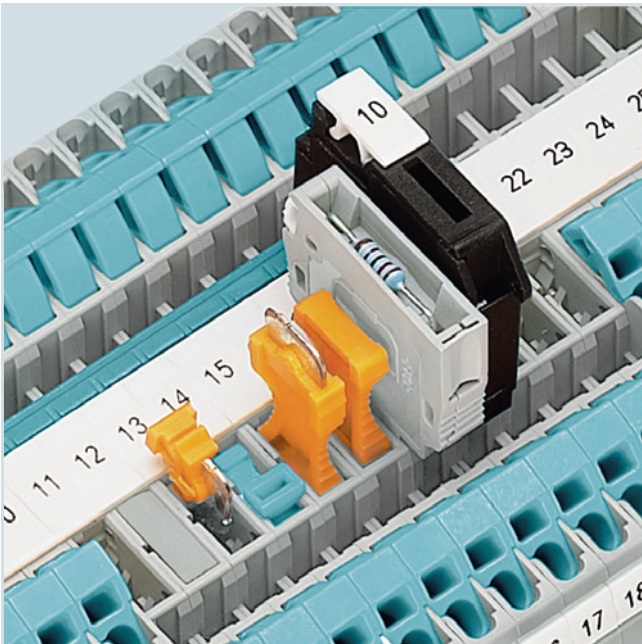

The universal plug-in zone of the isolating terminal can accommodate isolated through-type connectors, isolating plugs, component connectors and fused connectors. The isolating element (isolating plug) must not be replaced under load.

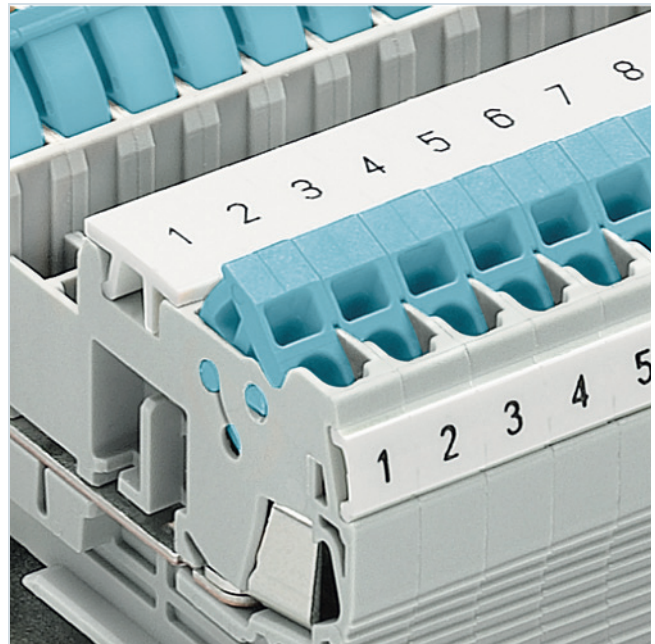

The unambiguous and easy-to-read marking in the center of the terminal is essential for time-saving installation. In addition to the large inscription in the center, each clamping point can also be labeled separately.

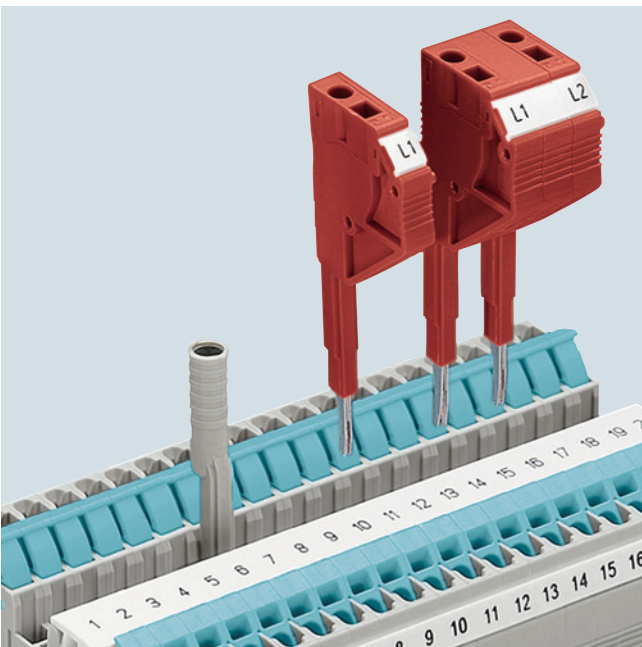

Test adapters are available for $\varnothing 4$ mm test and safety test plugs. Test plugs can be individually assembled, thanks to the modular design of the test plugs. Measuring leads can be connected over a 1.5 mm^2 spring-loaded/insulation displacement terminal.

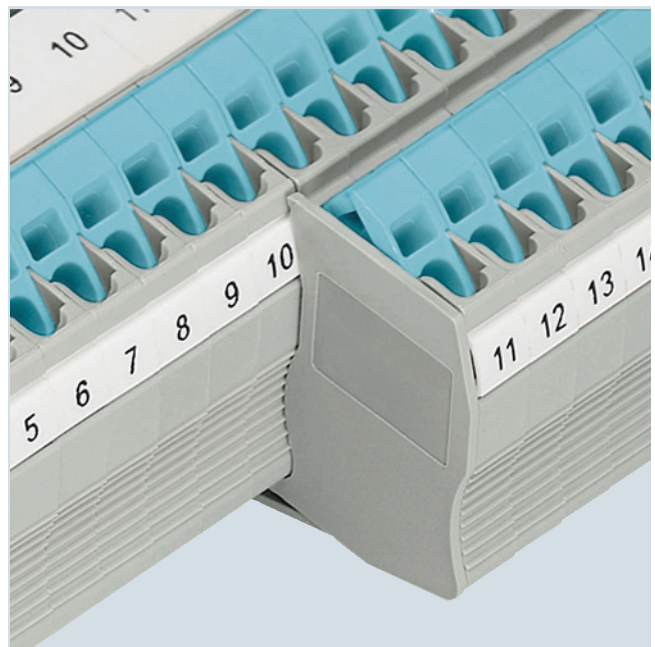

The cover segment is used to cover multi-wire terminals when mounting two-wire terminals side by side. These devices meet all fingerproof requirements.

Terminal Blocks

8WH3 Insulation Displacement Terminals

8WH through-type terminals

Overview

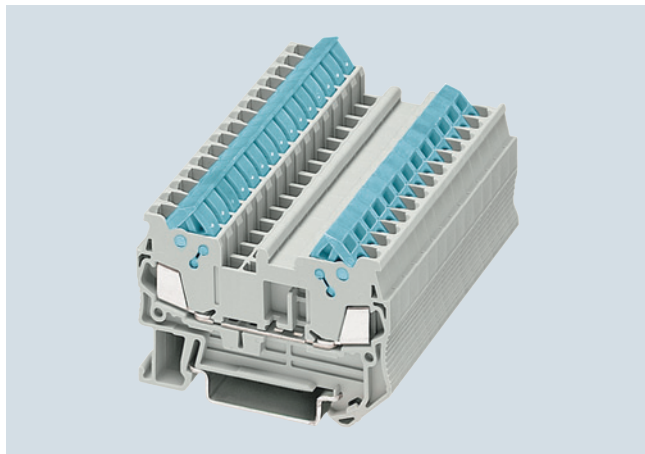





A key feature of the insulation displacement through-type terminal is its compact design. With its clear and space-saving front connection arrangement, this insulation displacement series provides additional space between the cable ducts for wiring. Using the double bridge shaft, it is also possible to use individual chain bridging, as well as a reducing comb, e.g. from a 2.5 mm² spring-loaded through-type terminal to a 35 mm² spring-loaded through-type terminal. Used in this way, reducing combs enable the quick and easy assembly of potential incoming feeders and distributors.

A label can be snapped on to the middle of the terminal at the front. Further labels can also be mounted flat on the side of the terminals.

Technical specifications

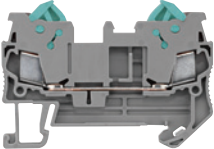
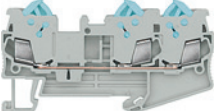
	8WH3000-0AE00 8WH3000-0AE01	8WH3003-0AE00 8WH3003-0AE01	8WH3004-0AE00 8WH3004-0AE01	8WH3000-0CE07	8WH3003-0CE07
Dimensions					
• Width/length/cover width in mm	5.2 / 58.8 / 2.2	5.2 / 76.4 / 2.2	5.2 / 94 / 2.2	5.2 / 58.8 / 2.2	5.2 / 76.4 / 2.2
• Height (TS 35/7.5 / TS 35/15) in mm	39.3 / 46.8				
Technical specifications acc. to IEC/DIN VDE					
• Max. load current in A / cross-section in mm ²	17.5 / 1.5			--	
• Rated impulse withstand voltage in kV / pollution degree	8 / 3				
• Overvoltage category / molded plastic group	III / I				
Conductor cross-section acc. to DIN VDE 0295					
• Core insulation	PVC / PE (other insulation types on request)				
• Solid/finely stranded H05V-U/R/K / H07V-U/R/K in mm ²	0.5 ... 1.0 / 1.5				
• Halogen-free H05Z-U/R/K / H07Z-U/R/K in mm ²	0.5 ... 1.0 / 1.5				
• Finely stranded / very finely stranded					
- (Strand Ø ≥ 0.1 mm) in mm ²	0.25 ... 0.34				
- (Strand Ø ≥ 0.19 mm) AWG	24 ... 16				
Number of circuits					
• At least 100x the same cross-section in mm ²	0.25 ... 1.5				
Molded plastic type	PA				
• Flammability Class acc. to UL 94	V0				
Approval data (UL/cUL and CSA)					
• Rated voltage / rated current / conductor sizes					
- UL/cUL: in V/A / AWG	600 / 10 / 24 ... 16			-- / -- / 24 ... 16	
- CSA: in V/A / AWG	--				
Support rails/protective conductor busbars	--				see page 14/3, section "Support rails"
	8WH3004-0CE07	8WH3000-0AF00 8WH3000-0AF01	8WH3003-0AF00 8WH3003-0AF01	8WH3000-0CF07	8WH3003-0CF07
Dimensions					
• Width/length/cover width in mm	5.2 / 94 / 2.2	6.2 / 62.6 / 2.2	6.2 / 82.5 / 2.2	6.2 / 62.6 / 2.2	6.2 / 82.5 / 2.2
• Height (TS 35/7.5 / TS 35/15) in mm	39.3 / 46.8		42.8 / 50.3	39.3 / 46.8	42.8 / 50.3
Technical specifications acc. to IEC/DIN VDE					
• Max. load current in A / cross-section in mm ²	--	24 / 2.5		--	
• Rated impulse withstand voltage in kV / pollution degree	8 / 3				
• Overvoltage category / molded plastic group	III / I				
Conductor cross-section acc. to DIN VDE 0295					
• Core insulation	PVC / PE (other insulation types on request)				
• Solid/finely stranded H05V-U/R/K / H07V-U/R/K in mm ²	0.5 ... 1.0 / 1.5	0.5 ... 1.5 / 1.5 ... 2.5			
• Halogen-free H05Z-U/R/K / H07Z-U/R/K in mm ²	0.5 ... 1.0 / 1.5	0.5 ... 1.5 / 1.5 ... 2.5			
• Finely stranded / very finely stranded					
- (Strand Ø ≥ 0.1 mm) in mm ²	0.25 ... 0.34	--			
- (Strand Ø ≥ 0.19 mm) AWG	24 ... 16	20 ... 14			
Number of circuits					
• At least 100x the same cross-section in mm ²	0.25 ... 1.5	0.5 ... 2.5			
Molded plastic type	PA				
• Flammability Class acc. to UL 94	V0				
Approval data (UL/cUL and CSA)					
• Rated voltage / rated current / conductor sizes					
- UL/cUL: in V/A / AWG	-- / -- / 24 ... 16	Applied for			
- CSA: in V/A / AWG	--	Applied for			
Support rails/protective conductor busbars	see page 14/3, section "Support rails"	--			see page 14/3, section "Support rails"

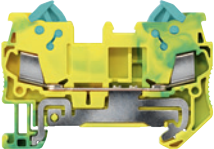
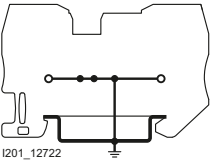

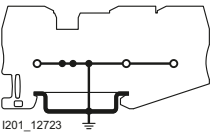
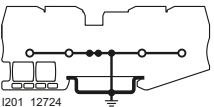

Selection and ordering data

Version	SD	Article No. www.siemens.com/ product?Article No.	Price per PU	PU (UNIT, SET, M)	PS	PG
d						
Terminal size 1.5 mm²						
Through-type terminals, terminal size 1.5 mm²						
	<ul style="list-style-type: none"> Terminal width 5.2 mm Connection data <ul style="list-style-type: none"> Rigid 0.25 ... 1.5 mm² Flexible 0.25 ... 1.5 mm² AWG 24 ... 16 I = 17.5 A U = 800 V More information under <i>Technical specifications</i> 					
8WH3000-0AE00						
	<ul style="list-style-type: none"> Gray <ul style="list-style-type: none"> Two clamping points Three clamping points Four clamping points Blue <ul style="list-style-type: none"> Two clamping points Three clamping points Four clamping points 					
8WH3003-0AE00						
	<ul style="list-style-type: none"> More information under <i>Technical specifications</i> 					
8WH3004-0AE00						
PE through-type terminals, terminal size 1.5 mm²						
	<ul style="list-style-type: none"> Green-yellow Terminal width 5.2 mm Connection data <ul style="list-style-type: none"> Rigid 0.25 ... 1.5 mm² Flexible 0.25 ... 1.5 mm² AWG 24 ... 16 More information under <i>Technical specifications</i> 					
8WH3000-0CE07						
	<ul style="list-style-type: none"> Two clamping points Three clamping points Four clamping points 					
8WH3000-0CE07						
						
8WH3003-0CE07						
						
8WH3004-0CE07						
						
8WH3004-0CE07						
		8WH3000-0AE00 8WH3003-0AE00 8WH3004-0AE00 8WH3000-0AE01 8WH3003-0AE01 8WH3004-0AE01		1 50 units 1BT 1 50 units 1BT 1 50 units 1BT 1 50 units 1BT 1 50 units 1BT 1 50 units 1BT		
		8WH3000-0CE07 8WH3003-0CE07 8WH3004-0CE07		1 50 units 1BT 1 50 units 1BT 1 50 units 1BT		

Terminal Blocks

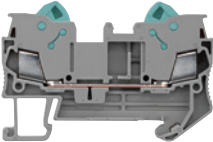
8WH3 Insulation Displacement Terminals

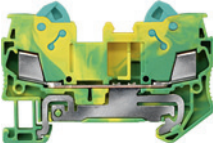
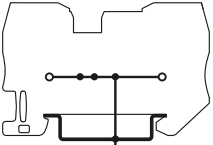

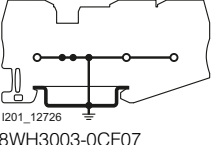

8WH through-type terminals

Version	SD	Article No. www.siemens.com/ product?Article.No.	Price per PU	PU (UNIT, SET, M)	PS	PG			
d									
Terminal size 2.5 mm²									
 <p>8WH3000-0AF00</p>	Through-type terminals, terminal size 2.5 mm² <ul style="list-style-type: none"> Terminal width 6.2 mm Connection data <ul style="list-style-type: none"> Rigid 0.5 ... 2.5 mm² Flexible 0.5 ... 2.5 mm² AWG 20 ... 14 I = 24 A U = 800 V 								
 <p>8WH3003-0AF00</p>	Versions <ul style="list-style-type: none"> Gray <ul style="list-style-type: none"> Two clamping points Three clamping points Blue <ul style="list-style-type: none"> Two clamping points Three clamping points 								
Note On terminals with three clamping points, the total current through all connected conductors must not exceed the max. load current.									
PE through-type terminals, terminal size 2.5 mm² <ul style="list-style-type: none"> Green-yellow Terminal width 6.2 mm Connection data <ul style="list-style-type: none"> Rigid 0.5 ... 2.5 mm² Flexible 0.5 ... 2.5 mm² AWG 20 ... 14 									
 <p>8WH3000-0CF07</p>	Versions <ul style="list-style-type: none"> Two clamping points Three clamping points 								
 <p>I201_12725 8WH3000-0CF07</p>	8WH3000-0CF07 8WH3003-0CF07						1	50 units	1BT
 <p>8WH3003-0CF07</p>	8WH3003-0CF07						1	50 units	1BT
 <p>I201_12726 8WH3003-0CF07</p>									

Terminal Blocks

8WH3 Insulation Displacement Terminals

8WH through-type terminals

Version	SD	Article No. www.siemens.com/ product?Article No.	Price per PU	PU (UNIT, SET, M)	PS	PG
Accessories						
 8WH9070-0JA00	Compartment partitions, for terminal sizes 1.5 ... 2.5 mm² <ul style="list-style-type: none"> For visual and electrical separation of terminal groups 2 mm thick 					
	Versions <ul style="list-style-type: none"> Two clamping points Three clamping points 					
 8WH9070-0LA00	Compartment partitions, for terminal size 1.5 mm² and four connection points					
 8WH9001-1AA00	Covers, for terminal size 1.5 mm² Gray					
	Versions <ul style="list-style-type: none"> Two clamping points Three clamping points Four clamping points 					
 8WH9000-1AA00	Covers, for terminal size 2.5 mm² Gray					
	Versions <ul style="list-style-type: none"> Two clamping points Three clamping points 					
 8WH9001-0AA00	Cover segments, for three or four clamping points <ul style="list-style-type: none"> Gray For covering multi-wire terminals when mounting two-wire terminals side-by-side 					
	Versions <ul style="list-style-type: none"> For terminal size 2.5 mm² 					

For general accessories for 8WH terminal blocks, see [page 14/135](#).

Terminal Blocks

8WH3 Insulation Displacement Terminals

8WH two-tier terminals

Overview

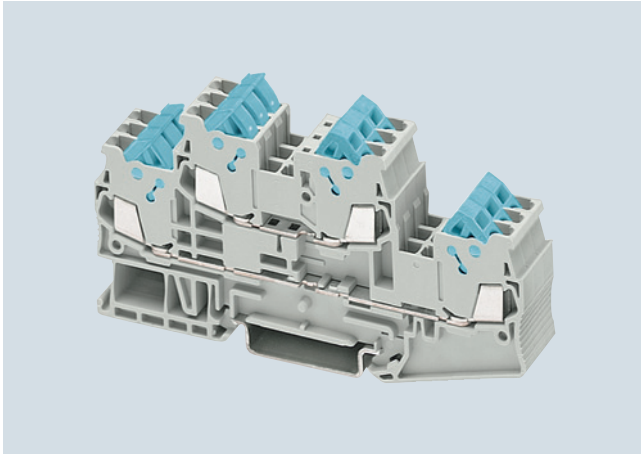

Key features of the IDC two-tier terminals for terminal size 1.5 mm^2 are their ultra compact design and the double bridge shaft for each tier. This enables simultaneous bridging and testing.

With its clear and space-saving front connection arrangement, this two-tier terminal series provides additional space between the cable ducts for wiring.

The PE/ground conductor terminal of this range meets all the requirements of IEC 60 947-7-2.

These include in particular:







- Low contact resistance
- Stainless clamping points and PE mounting foot
- Green-yellow enclosure and
- Additional inscription options

The clamping points of two-tier terminals can be inscribed with flat labels.

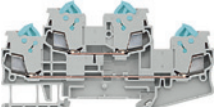
Technical specifications

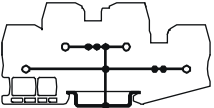
	8WH3020-0AE00 8WH3020-0AE01	8WH3020-0CE07
Dimensions		
• Width/length/cover width in mm	5.2 / 99.6 / 2.2	
• Height (TS 35/7.5 / TS 35/15) in mm	49.9 / 57.4	
Technical specifications acc. to IEC/DIN VDE		
• Max. load current in A / cross-section in mm^2	17.5 / 1.5	--
• Rated impulse withstand voltage in kV / pollution degree	6 / 3	
• Overvoltage category / molded plastic group	III / I	
Conductor cross-section acc. to DIN VDE 0295		
• Core insulation	PVC / PE (other insulation types on request)	
• Solid/finely stranded H05V-U/R/K / H07V-U/R/K in mm^2	0.4 ... 1.0 / 1.5	
• Halogen-free H05Z-U/R/K / H07Z-U/R/K in mm^2	0.5 ... 1.0 / 1.5	
• Finely stranded / very finely stranded		
- (Strand $\varnothing \geq 0.1 \text{ mm}$) in mm^2	0.25 ... 0.34	
- (Strand $\varnothing \geq 0.19 \text{ mm}$) AWG	24 ... 16	
Number of circuits		
• At least 100x the same cross-section in mm^2	0.25 ... 1.5	
Molded plastic type	PA	
• Flammability Class acc. to UL 94	V0	
Approval data (UL/cUL and CSA)		
• Rated voltage / rated current / conductor sizes		
- UL/cUL: in V/A / AWG	600 / 10 / 24 ... 16	-- / -- / 24 ... 16
- CSA: in V/A / AWG	--	
Support rails/protective conductor busbars	--	see page 14/3, section "Support rails"

Selection and ordering data

Version	SD	Article No. www.siemens.com/ product?Article No.	Price per PU	PU (UNIT, SET, M)	PS	PG
d						
Terminal size 1.5 mm²						
 <p>8WH3020-0AE00</p>	Two-tier terminals, terminal size 1.5 mm² <ul style="list-style-type: none"> Terminal width 5.2 mm  Connection data <ul style="list-style-type: none"> Rigid 0.25 ... 1.5 mm² Flexible 0.25 ... 1.5 mm² AWG 24 ... 16 I = 17.5 A U = 500 V More information under <i>Technical specifications</i> 					
	Versions <ul style="list-style-type: none"> Gray Blue 					
 <p>8WH3020-0CE07</p>  <p>8WH3020-0CE07</p>	PE two-tier terminals, terminal size 1.5 mm² <ul style="list-style-type: none"> Green-yellow Terminal width 5.2 mm  Connection data <ul style="list-style-type: none"> Rigid 0.25 ... 1.5 mm² Flexible 0.25 ... 1.5 mm² AWG 24 ... 16 More information under <i>Technical specifications</i> 					
	Versions <ul style="list-style-type: none"> Gray Blue 					
Accessories						
 <p>8WH9070-0MA00</p>	Compartment partitions, for terminal size 1.5 mm²		8WH9070-0MA00 100 50 units 1BT			
 <p>8WH9001-1BA00</p>	Covers, for terminal size 1.5 mm²		8WH9001-1BA00 100 50 units 1BT			

For general accessories for 8WH terminal blocks, see [page 14/135](#).

Terminal Blocks

8WH3 Insulation Displacement Terminals

8WH isolating terminals

Overview

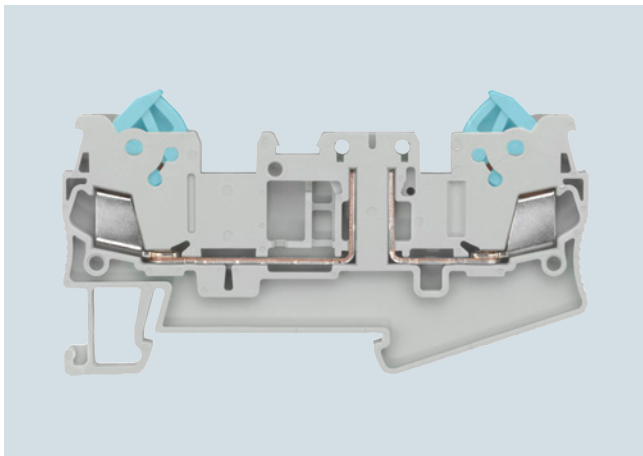

8WH3 isolating terminals using insulation displacement technology are available for special wiring tasks. Numerous wiring tasks can be performed on a terminal width of 5.2 mm by integrating the isolated through-type connector, the isolating plug, the component connector or the fused plug.

A label can be snapped on to the middle of each terminal at the front. Further labels can also be mounted flat on the side of the terminals.

The isolating element must not be replaced under load.

Technical specifications

	8WH3000-6AE00	8WH3000-6AF00
Dimensions		
• Width/length/cover width in mm	5.2 / 76.4 / 2.2	6.2 / 82.5 / 2.2
• Height (TS 35/7.5 / TS 35/15) in mm	39.3 / 46.8	42.8 / 50.3
Technical specifications acc. to IEC/DIN VDE		
• Max. load current in A / cross-section in mm ²	16 / 1.5	16 / 2.5
• Rated impulse withstand voltage in kV / pollution degree	6 / 3	
• Overvoltage category / molded plastic group	III / I	
Conductor cross-section acc. to DIN VDE 0295		
• Core insulation	PVC / PE (other insulation types on request)	
• Solid/finely stranded H05V-U/R/K / H07V-U/R/K in mm ²	0.5 ... 1.0 / 1.5	0.5 ... 1.0 / 1.5 ... 2.5
• Halogen-free H05Z-U/R/K / H07Z-U/R/K in mm ²	0.5 ... 1.0 / 1.5	0.5 ... 1.0 / 1.5 ... 2.5
• Finely stranded / very finely stranded		
- (Strand Ø ≥ 0.1 mm) in mm ²	0.25 ... 0.34	--
- (Strand Ø ≥ 0.19 mm) AWG	24 ... 16	20 ... 14
Number of circuits		
• At least 100x the same cross-section in mm ²	0.25 ... 1.5	0.5 ... 2.5
Molded plastic type		
• Flammability Class acc. to UL 94	PA V0	
Approval data (UL/cUL and CSA)		
• Rated voltage / rated current / conductor sizes		
- UL/cUL: in V/A / AWG	600 / 10 / 24 ... 16	Applied for
- CSA: in V/A / AWG	600 / 10 / 24 ... 16	Applied for

Selection and ordering data

Version	SD	Article No. www.siemens.com/ product?Article No.	Price per PU	PU (UNIT, SET, M)	PS	PG
	d					



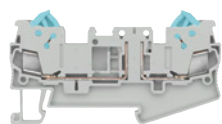

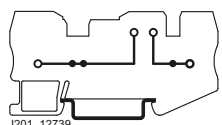

Terminal size 1.5 mm²



8WH3000-6AE00

1201_12739
8WH3000-6AE00

Isolating terminals, terminal size 1.5 mm²

- Gray
- Terminal width 5.2 mm
-      
- Connection data
 - Rigid 0.25 ... 1.5 mm²
 - Flexible 0.25 ... 1.5 mm²
 - AWG 24 ... 16
 - I = 16 A
 - U = 400 V
 - Current and voltage are determined by the fitted plug
- For further information, see [Technical specifications](#)



8WH3000-6AE00

1 50 units 1BT

Terminal Blocks

8WH3 Insulation Displacement Terminals

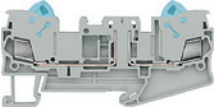
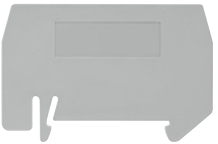
8WH isolating terminals

Version	SD	Article No. www.siemens.com/ product?Article.No.	Price per PU	PU (UNIT, SET, M)	PS	PG
d						
Terminal size 2.5 mm²						
		Isolating terminals, terminal size 2.5 mm²				
8WH3000-6AF00		<ul style="list-style-type: none"> • Gray • Terminal width 6.2 mm • Connection data <ul style="list-style-type: none"> - Rigid 0.5 ... 2.5 mm² - Flexible 0.5 ... 2.5 mm² - AWG 20 ... 14 - I = 16 A - U = 400 V - Current and voltage are determined by the fitted plug • More information under <i>Technical specifications</i> 				
Accessories						
		Compartment partitions, for terminal sizes 1.5 ... 2.5 mm² and three clamping points				
8WH9070-0KA00						
		Covers				
		Versions <ul style="list-style-type: none"> • For terminal size 1.5 mm² and three clamping points • For terminal size 2.5 mm² and three clamping points 				
8WH9001-2AA00						
		Cover segments				
		Versions <ul style="list-style-type: none"> • For terminal size 1.5 mm² and three or four clamping points • For terminal size 2.5 mm² and three or four clamping points 				
8WH9001-0AA00						





For general accessories for 8WH terminal blocks, see [page 14/135](#).

Terminal Blocks

8WH1 Screw Terminals

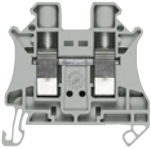
Introduction

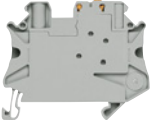
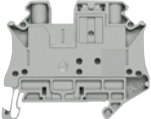
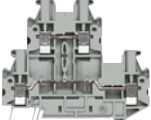
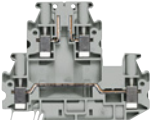
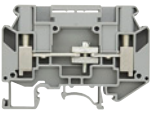
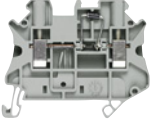
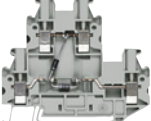
Overview

	Devices	Page	Function
	Through-type terminals	14/106	Connection of incoming and outgoing conductors up to 35 mm ²
	Fuse terminals	14/110	Terminals which can be used to protect control circuits, for example:
	Isolating blade terminals	14/112	Isolation of the circuit, e.g. for test purposes
	Isolating terminals	14/113	Isolation of the circuit, e.g. for test purposes
	Two-tier terminals	14/114	Compact form of the terminal blocks in which two connection wires can be installed
	Two-tier terminals with isolating function	14/117	Compact form of the terminal blocks in which two connection wires can be installed
	Measuring transformer terminals	14/119	Measuring transformer terminals permit clear and simple tests
	Diode terminals	14/122	Terminal blocks with integrated diodes
	Two-tier diode terminals	14/123	Terminal blocks with integrated diodes
	8WH high-current terminals	14/126	Connection of incoming and outgoing cables from 50 to 240 mm ²
	8WH shield terminals	14/130	Terminals for connection of shielded cables

Overview

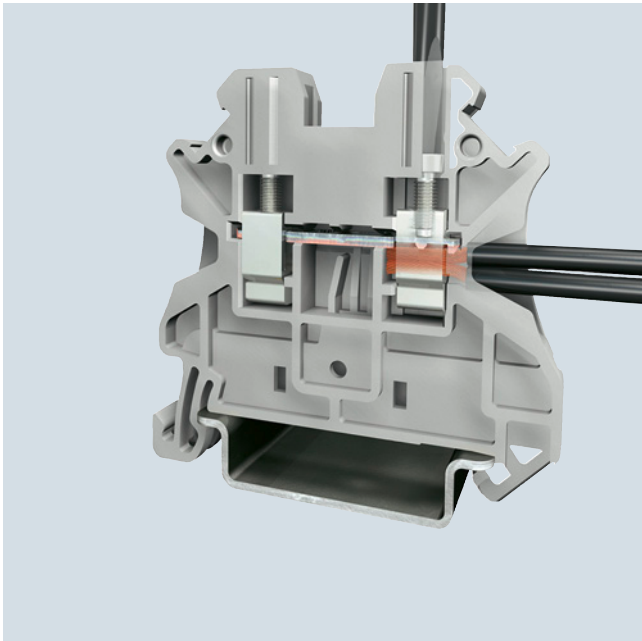

The screw terminal is characterized by its global standard, multi-conductor connection and maintenance-free design.

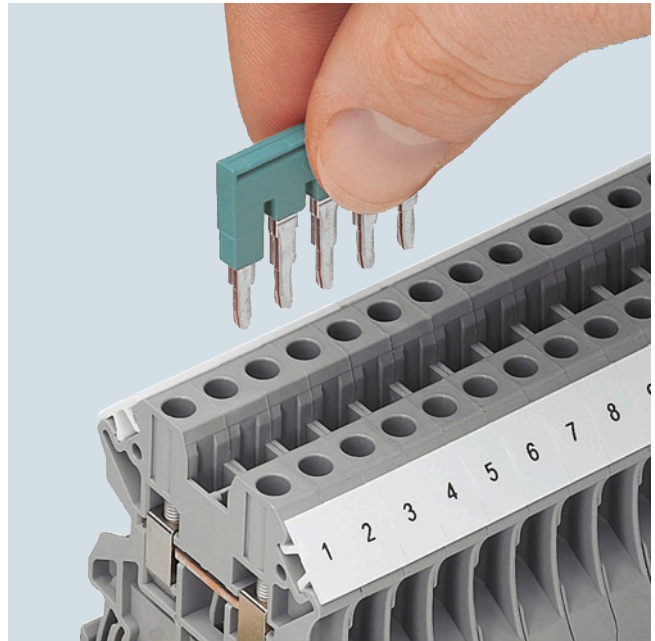

The potential distribution can be quickly implemented with the standardized connecting combs. Flexible chain bridging, level bridging, or skipping of several terminals are possible through two or more bridge shafts in all the terminals.

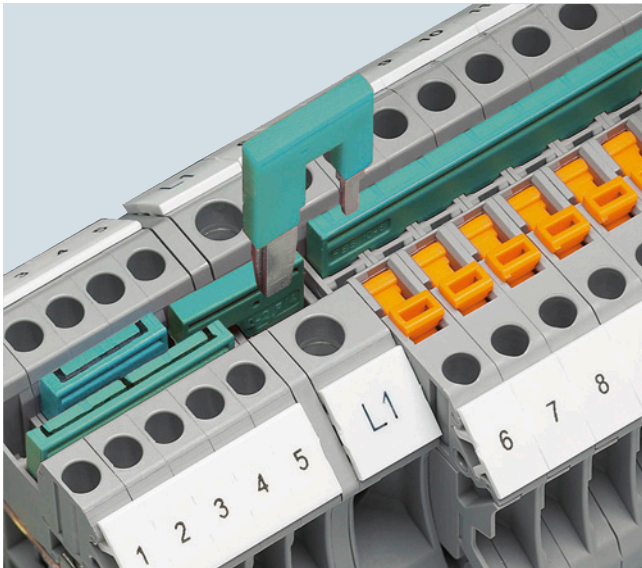



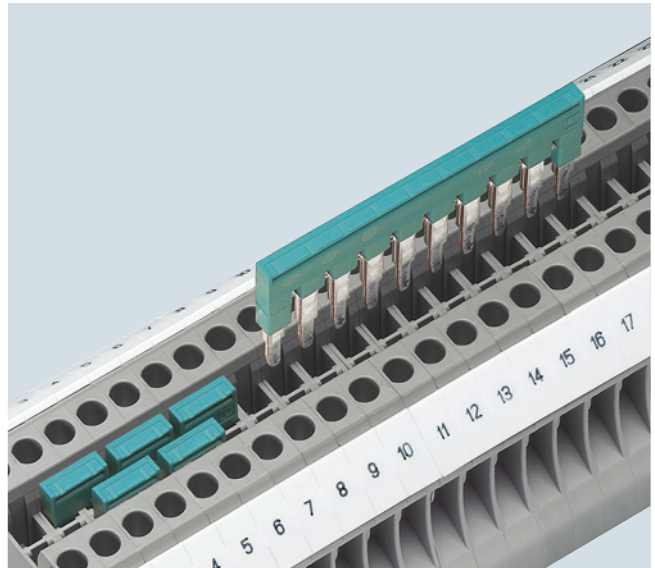





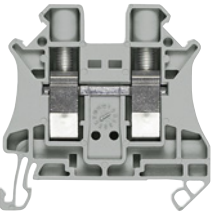

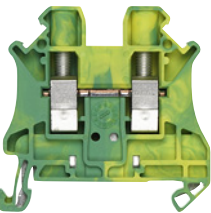
Reducing combs enable easy connection of terminals with various nominal cross-sections and terminal designs. Reducing combs can be used for the quick assembly of infeed blocks.



The double bridge shaft enables an assembly of any number of terminals with two-pole jumpers. The 2-pole to 50-pole jumpers enable up to 50 terminals to be connected in a single step.

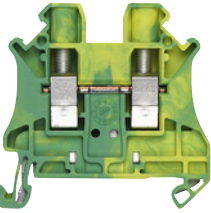







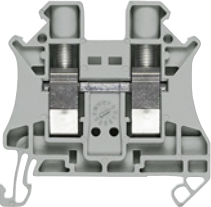

Selection and ordering data

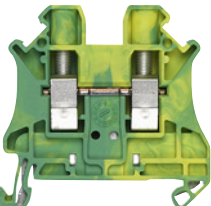
Version	SD	Article No. www.siemens.com/ product?Article No.	Price per PU	PU (UNIT, SET, M)	PS	PG		
d								
Terminal size 2.5 mm²								
 <p>8WH1000-0AF00</p>	Through-type terminals, terminal size 2.5 mm² <ul style="list-style-type: none"> •  US:  • Terminal width 5.2 mm • $I_{max} = 32$ A • $U_{max} = 1000$ V • AWG 26 ... 12 • Connection capacity, one conductor <ul style="list-style-type: none"> - Rigid 0.14 ... 4 mm² - Flexible 0.14 ... 4 mm² • Connection capacity, two conductors <ul style="list-style-type: none"> - Rigid 0.14 ... 1.5 mm² - Flexible 0.14 ... 1.5 mm² 							
	Versions <ul style="list-style-type: none"> • Gray • Blue • Red • Black • Yellow • Green • Orange 						8WH1000-0AF00 8WH1000-0AF01 8WH1000-0AF02 8WH1000-0AF08 8WH1000-0AF06 8WH1000-0AF03 8WH1000-0AF04	1 50 units 1BT 1 50 units 1BT 1 50 units 1BT 1 50 units 1BT 1 50 units 1BT 1 50 units 1BT 1 50 units 1BT
 <p>8WH1000-0CF07</p>	PE through-type terminals, terminal size 2.5 mm² <ul style="list-style-type: none"> •  US:  • Terminal width 5.2 mm • AWG 26 ... 12 • Connection capacity, one conductor <ul style="list-style-type: none"> - Rigid 0.14 ... 4 mm² - Flexible 0.14 ... 4 mm² • Connection capacity, two conductors <ul style="list-style-type: none"> - Rigid 0.14 ... 1.5 mm² - Flexible 0.14 ... 1.5 mm² • Green-yellow 		8WH1000-0CF07				1 50 units 1BT	1BT
	Terminal size 4 mm²							
 <p>8WH1000-0AG00</p>	Through-type terminals, terminal size 4 mm² <ul style="list-style-type: none"> •  US:  • Terminal width 6.2 mm • $I_{max} = 41$ A • $U_{max} = 1000$ V • AWG 26 ... 10 • Connection capacity, one conductor <ul style="list-style-type: none"> - Rigid 0.14 ... 6 mm² - Flexible 0.14 ... 6 mm² • Connection capacity, two conductors <ul style="list-style-type: none"> - Rigid 0.14 ... 1.5 mm² - Flexible 0.14 ... 1.5 mm² 							
	Versions <ul style="list-style-type: none"> • Gray • Blue • Red • Black • Orange 						8WH1000-0AG00 8WH1000-0AG01 8WH1000-0AG02 8WH1000-0AG08 8WH1000-0AG04	1 50 units 1BT 1 50 units 1BT 1 50 units 1BT 1 50 units 1BT 1 50 units 1BT
 <p>8WH1000-0CG07</p>	PE through-type terminals, terminal size 4 mm² <ul style="list-style-type: none"> •  US:  • Terminal width 6.2 mm • AWG 26 ... 10 • Connection capacity, one conductor <ul style="list-style-type: none"> - Rigid 0.14 ... 6 mm² - Flexible 0.14 ... 6 mm² • Connection capacity, two conductors <ul style="list-style-type: none"> - Rigid 0.14 ... 1.5 mm² - Flexible 0.14 ... 1.5 mm² • Green-yellow 		8WH1000-0CG07				1 50 units 1BT	1BT

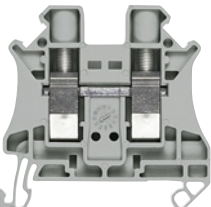
Terminal Blocks

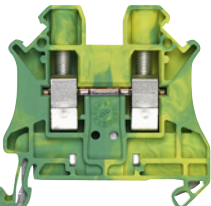
8WH1 Screw Terminals

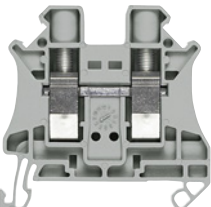
8WH through-type terminals

Version	SD	Article No. www.siemens.com/ product?Article No.	Price per PU	PU (UNIT, SET, M)	PS	PG
Terminal size 6 mm²						
 <p>8WH1000-0AH00</p>	Through-type terminals, terminal size 6 mm² <ul style="list-style-type: none"> •   US, © • Terminal width 8.2 mm • $I_{max} = 57$ A • $U_{max} = 1000$ V • AWG 24 ... 8 • Connection capacity, one conductor <ul style="list-style-type: none"> - Rigid 0.2 ... 10 mm² - Flexible 0.2 ... 10 mm² • Connection capacity, two conductors <ul style="list-style-type: none"> - Rigid 0.2 ... 2.5 mm² - Flexible 0.2 ... 2.5 mm² 					
	Versions <ul style="list-style-type: none"> • Gray • Blue • Red • Black 		8WH1000-0AH00 8WH1000-0AH01 8WH1000-0AH02 8WH1000-0AH08		1 50 units	1BT
 <p>8WH1000-0CH07</p>	PE through-type terminals, terminal size 6 mm² <ul style="list-style-type: none"> •   US, © • Terminal width 8.2 mm • AWG 24 ... 8 • Connection capacity, one conductor <ul style="list-style-type: none"> - Rigid 0.2 ... 10 mm² - Flexible 0.2 ... 10 mm² • Connection capacity, two conductors <ul style="list-style-type: none"> - Rigid 0.2 ... 2.5 mm² - Flexible 0.2 ... 2.5 mm² • Green-yellow 		8WH1000-0CH07		1 50 units	1BT
	Versions <ul style="list-style-type: none"> • Gray • Blue 					
Terminal size 10 mm²						
 <p>8WH1000-0AJ00</p>	Through-type terminals, terminal size 10 mm² <ul style="list-style-type: none"> •   US, © • Terminal width 10.2 mm • $I_{max} = 76$ A • $U_{max} = 1000$ V • AWG 20 ... 6 • Connection capacity, one conductor <ul style="list-style-type: none"> - Rigid 0.5 ... 16 mm² - Flexible 0.5 ... 16 mm² • Connection capacity, two conductors <ul style="list-style-type: none"> - Rigid 0.5 ... 4 mm² - Flexible 0.5 ... 4 mm² 					
	Versions <ul style="list-style-type: none"> • Gray • Blue 		8WH1000-0AJ00 8WH1000-0AJ01		1 50 units	1BT
 <p>8WH1000-0CJ07</p>	PE through-type terminals, terminal size 10 mm² <ul style="list-style-type: none"> •   US, © • Terminal width 10.2 mm • AWG 20 ... 6 • Connection capacity, one conductor <ul style="list-style-type: none"> - Rigid 0.5 ... 16 mm² - Flexible 0.5 ... 16 mm² • Connection capacity, two conductors <ul style="list-style-type: none"> - Rigid 0.5 ... 4 mm² - Flexible 0.5 ... 4 mm² • Green-yellow 		8WH1000-0CJ07		1 50 units	1BT
	Versions <ul style="list-style-type: none"> • Gray • Blue 					
Terminal size 16 mm²						
 <p>8WH1000-0AK00</p>	Through-type terminals, terminal size 16 mm² <ul style="list-style-type: none"> •   US, © • Terminal width 12.2 mm • $I_{max} = 101$ A • $U_{max} = 1000$ V • AWG 16 ... 4 • Connection capacity, one conductor <ul style="list-style-type: none"> - Rigid 1.5 ... 25 mm² - Flexible 1.5 ... 25 mm² • Connection capacity, two conductors <ul style="list-style-type: none"> - Rigid 1 ... 6 mm² - Flexible 1 ... 6 mm² 					
	Versions <ul style="list-style-type: none"> • Gray • Blue 		8WH1000-0AK00 8WH1000-0AK01		1 50 units	1BT

Terminal Blocks

8WH1 Screw Terminals

8WH fuse terminals

Overview

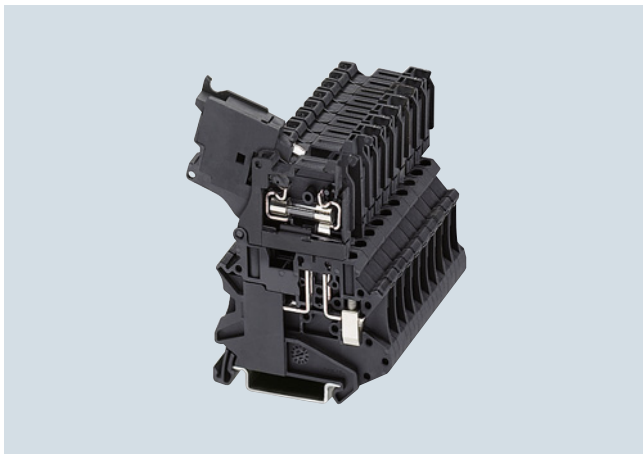

The 8WH fuse terminals adopt the function of the fuse holders for 5 × 20 mm and 6.3 × 32 mm G fuse links and all potential distribution tasks with the double bridge shaft.

The individual clamping points can be inscribed at the front using labels.





Fuses must not be replaced under load.

Technical specifications

	8WH1000-1GG08	8WH1000-1KG38	8WH1000-1MG88	8WH1000-1HH08	8WH1000-1PH38
Dimensions					
• Width/length/cover width in mm	6.2 / 57.8 / --			8.2 / 57.8 / --	
• Height (NS 35/7.5 / NS 35/15) in mm	73 / 80.5				
Technical specifications acc. to IEC/DIN VDE					
• Max. load current in A ¹⁾ / cross-section in mm ²	6.3 / 6			10 / 10	
• Rated impulse withstand voltage in kV / pollution degree	6 kV / 3			8 kV / 3	
• Rated insulation voltage U_i in V acc. to IEC 60497-7-1	500			630	
• Overvoltage category / molded plastic group	III / I			6 kV / 3	
Connection capacities					
• Flexible with end sleeve, with plastic sleeve in mm ²	0.25 ... 4			0.25 ... 6	
• Flexible with end sleeve, without plastic sleeve in mm ²	0.25 ... 4			0.25 ... 6	
• Flexible with two-wire connection end sleeve, with plastic sleeve in mm ²	0.5 ... 2.5			0.5 ... 4	
• Rigid in mm ²	0.14 ... 6			0.2 ... 10	
Stripped length in mm	9			10	
Tightening torque in Nm	0.6 ... 0.8			1.5 ... 1.8	
Molded plastic type	PA				
• Flammability Class acc. to UL 94	V0				
Approval data (UL/cUL and CSA)					
• Rated voltage / rated current / conductor sizes					
- UL/cUL: in V/A / AWG	600 / 6.3 / 26 ... 10			600 / 16 / 24 ... 8	
- CSA: in V/A / AWG	600 / 6.3 / 26 ... 10			-- / -- / --	

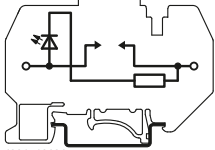
¹⁾ Please note the maximum power loss.

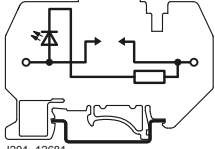
Selection and ordering data

Version	SD	Article No. www.siemens.com/ product?Article No.	Price per PU	PU (UNIT, SET, M)	PS	PG
d						
Terminal size 4 mm²						
 <p>8WH1000-1GG08</p>  <p>8WH1000-1MG88</p>	Fuse terminals, terminal size 4 mm², for G fuse links 5 x 20 mm <ul style="list-style-type: none"> •  US • Terminal width 6.2 mm • $I_{max} = 6.3$ A • $U_{max} = 500$ V • AWG 26 ... 10 • Connection capacity, one conductor <ul style="list-style-type: none"> - Rigid 0.14 ... 6 mm² - Flexible 0.14 ... 6 mm² • Connection capacity, two conductors <ul style="list-style-type: none"> - Rigid 0.14 ... 1.5 mm² - Flexible 0.14 ... 1.5 mm² • Enclosed at both ends • Black 					
	Versions <ul style="list-style-type: none"> • Without LED • With LED 10 ... 30 V AC/DC • With LED 110 ... 250 V AC/DC 					
		8WH1000-1GG08 8WH1000-1KG38 8WH1000-1MG88		1 50 units 1 50 units 1 50 units	1BT 1BT 1BT	
Terminal size 6 mm²						
 <p>8WH1000-1HH08</p>  <p>8WH1000-1PH38</p>	Fuse terminals, terminal size 6 mm², for G fuse links 6.3 x 32 mm (inch fuses) <ul style="list-style-type: none"> •  US • Terminal width 8.2 mm • $I_{max} = 10$ A • $U_{max} = 630$ V • AWG 24 ... 8 • Connection capacity, one conductor <ul style="list-style-type: none"> - Rigid 0.2 ... 10 mm² - Flexible 0.2 ... 10 mm² • Connection capacity, two conductors <ul style="list-style-type: none"> - Rigid 0.2 ... 2.5 mm² - Flexible 0.2 ... 2.5 mm² • Enclosed at both ends • Black 					
	Versions <ul style="list-style-type: none"> • Without LED • With LED 12 ... 30 V AC/DC 					
		8WH1000-1HH08 8WH1000-1PH38		1 50 units 1 50 units	1BT 1BT	
Accessories						
 <p>8WH9002-8AC10</p>	Reducing combs, for connecting terminals, from terminal size 6 mm² to 2.5 or 4 mm², from screw to screw					
		8WH9002-8AC10		1 10 units	1BT	

For general accessories for 8WH terminal blocks, see page 14/135.

Terminal Blocks

8WH1 Screw Terminals

8WH isolating blade terminals

Overview



Key features of the 8WH isolating blade terminals are their slim design and high current carrying capacity of 20 A. They can be bridged with standard terminal jumpers over the double bridge shaft.



The individual clamping points can be inscribed at the front using labels.

The isolating element must not be replaced under load.

Technical specifications

8WH1000-6CG00	
Dimensions	
• Width/length/cover width in mm	6.2 / 57.8 / --
• Height (NS 35/7.5 / NS 35/15) in mm	49.1 / 56.6
Technical specifications acc. to IEC/DIN VDE	
• Max. load current in A / cross-section in mm ²	20 / 6
• Rated impulse withstand voltage in kV / pollution degree	6 kV / 3
• Rated insulation voltage U_i in V acc. to IEC 60497-7-1	500
• Overvoltage category / molded plastic group	III / I
Connection capacities	
• Flexible with end sleeve, with plastic sleeve in mm ²	0.25 ... 4
• Flexible with end sleeve, without plastic sleeve in mm ²	0.25 ... 4
• Flexible with two-wire connection end sleeve, with plastic sleeve in mm ²	0.5 ... 2.5
• Rigid in mm ²	0.14 ... 6
Stripped length in mm	9
Tightening torque in Nm	0.6 ... 0.8
Molded plastic type	PA
• Flammability Class acc. to UL 94	V0
Approval data (UL/cUL and CSA)	
• Rated voltage / rated current / conductor sizes	
- UL/cUL: in V/A / AWG	600 / 16 / 26 ... 10
- CSA: in V/A / AWG	600 / 16 / 26 ... 10

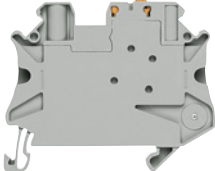
Selection and ordering data

Version	SD	Article No. www.siemens.com/ product?Article No.	Price per PU	PU (UNIT, SET, M)	PS	PG
	d					
Terminal size 4 mm²						
		Isolating blade terminals, terminal size 4 mm²				
8WH1000-6CG00		<ul style="list-style-type: none"> •  US • Terminal width 6.2 mm • $I_{max} = 20$ A • $U_{max} = 500$ V • AWG 26 ... 12 • Connection capacity, one conductor <ul style="list-style-type: none"> - Rigid 0.14 ... 4 mm² - Flexible 0.14 ... 4 mm² • Connection capacity, two conductors <ul style="list-style-type: none"> - Rigid 0.14 ... 1.5 mm² - Flexible 0.14 ... 1.5 mm² • Enclosed at both ends • Gray 				
		8WH1000-6CG00		1 50 units		1BT
Accessories						
		Warning covers, for terminal size 4 mm²				
		<ul style="list-style-type: none"> • Lightning symbol • Width 6.2 mm • Yellow 				
		8WH9063-5BA06		100 50 units		1BT

For general accessories for 8WH terminal blocks, see page 14/135.

Overview

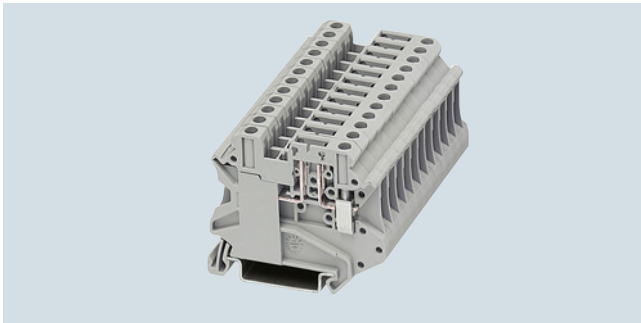

8WH isolating terminals serve for mounting various function plugs.

The individual clamping points can be inscribed at the front using labels.

The isolating element must not be replaced under load.

Technical specifications

	8WH1000-6AG00	8WH1000-6AH00
Dimensions		
• Width/length/cover width in mm	6.2 / 57.8 / --	
• Height (NS 35/7.5 / NS 35/15) in mm	49.1 / 56.6	73 / 80.5
Technical specifications acc. to IEC/DIN VDE		
• Max. load current in A / cross-section in mm ²	20 / 6	20 / 10
• Rated impulse withstand voltage in kV / pollution degree	6 kV / 3	
• Rated insulation voltage U_i in V acc. to IEC 60497-7-1	500	
• Overvoltage category / molded plastic group	III / I	
Connection capacities		
• Flexible with end sleeve, with plastic sleeve in mm ²	0.25 ... 4	0.26 ... 6
• Flexible with end sleeve, without plastic sleeve in mm ²	0.25 ... 4	0.26 ... 6
• Flexible with two-wire connection end sleeve, with plastic sleeve in mm ²	0.5 ... 2.5	0.5 ... 4
• Rigid in mm ²	0.14 ... 6	0.2 ... 10
Stripped length in mm	9	10
Tightening torque in Nm	0.6 ... 0.8	1.5 ... 1.8
Molded plastic type	PA	
• Flammability Class acc. to UL 94	V0	
Approval data (UL/cUL and CSA)		
• Rated voltage / rated current / conductor sizes		
- UL/cUL: in V/A / AWG	600 / 16 / 26 ... 10	-- / -- / --
- CSA: in V/A / AWG	600 / 16 / 26 ... 10	-- / -- / --

Selection and ordering data

Version	SD	Article No. www.siemens.com/ product?Article No.	Price per PU	PU (UNIT, SET, M)	PS	PG
	d					

Terminal size 4 mm²

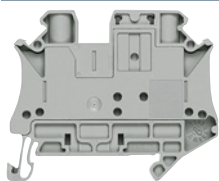

8WH1000-6AG00

Isolating terminal, terminal size 4 mm²

- US
- Terminal width 6.2 mm
- $I_{max} = 20$ A
- $U_{max} = 400$ V
- AWG 26 ... 10
- Connection capacity, one conductor
 - Rigid 0.14 ... 6 mm²
 - Flexible 0.14 ... 6 mm²
- Connection capacity, two conductors
 - Rigid 0.14 ... 1.5 mm²
 - Flexible 0.14 ... 1.5 mm²
- Enclosed at both ends
- Gray

8WH1000-6AG00

1 50 units 1BT

Terminal size 6 mm²

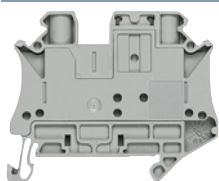

8WH1000-6AH00

Isolating terminal, terminal size 6 mm²

- US
- Terminal width 8.2 mm
- $I_{max} = 20$ A
- $U_{max} = 500$ V
- AWG 24 ... 8
- Connection capacity, one conductor
 - Rigid 0.2 ... 10 mm²
 - Flexible 0.2 ... 10 mm²
- Connection capacity, two conductors
 - Rigid 0.2 ... 2.5 mm²
 - Flexible 0.2 ... 2.5 mm²
- Enclosed at both ends
- Gray

8WH1000-6AH00

1 50 units 1BT

Terminal Blocks

8WH1 Screw Terminals

8WH two-tier terminals

Overview

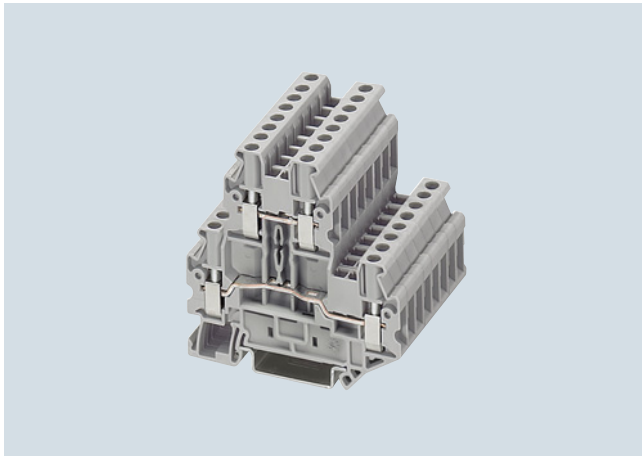

The compact 8WH1 two-tier terminal is available in the nominal cross-sections 2.5 and 4 mm². The voltage levels routed in a 5.2 mm or 6.2 mm grid through two tiers reduce the space required in the control cabinet by a further 50%. Two integral bridge shafts per tier and two facilities for large inscriptions of all clamping points are provided.

With 8WH1025 two-tier terminals the upper and lower level are connected.





The tier offset on the 8WH two-tier terminals allows for excellent access to the lower level, even when fully wired. Spacer plates can be used to compensate for the tier offset if other terminals are mounted side by side.

The clamping points of the 8WH1 two-tier terminals can be inscribed at the front using the labels.

Technical specifications

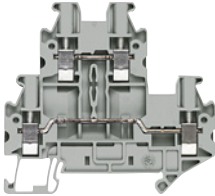
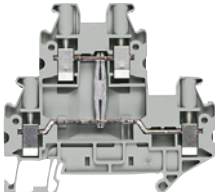
	8WH1020-0AF00 8WH1020-0AF01	8WH1020-0AG00 8WH1020-0AG01	8WH1020-0CF07	8WH1020-0CG07
Dimensions				
• Width/length/cover width in mm	5.2 / 69.9 / 2.2	6.2 / 69.9 / 2.2	5.2 / 69.9 / 2.2	6.2 / 69.9 / 2.2
• Height (NS 35/7.5 / NS 35/15) in mm	65 / 72.5			
Technical specifications acc. to IEC/DIN VDE				
• Max. load current in A / cross-section in mm ²	28 / 4	36 / 6	-- / 4	-- / 6
• Rated impulse withstand voltage in kV / pollution degree	6 kV / 3	8 kV / 3		
• Rated insulation voltage U_i in V acc. to IEC 60497-7-1	500	800	--	
• Overvoltage category / molded plastic group	III / I			
Connection capacities				
• Flexible with end sleeve, with plastic sleeve in mm ²	0.25 ... 2.5	0.25 ... 4	0.25 ... 2.5	0.25 ... 4
• Flexible with end sleeve, without plastic sleeve in mm ²	0.25 ... 2.5	0.25 ... 4	0.25 ... 2.5	0.25 ... 4
• Flexible with two-wire connection end sleeve, with plastic sleeve in mm ²	0.5 ... 1.5	0.5 ... 2.5	0.5 ... 1.5	0.5 ... 2.5
• Rigid in mm ²	0.14 ... 4	0.14 ... 6	0.14 ... 4	0.14 ... 6
Stripped length in mm	9			
Tightening torque in Nm	0.5 ... 0.6	0.6 ... 0.8	0.5 ... 0.6	0.6 ... 0.8
Molded plastic type	PA			
• Flammability Class acc. to UL 94	V0			
Approval data (UL/cUL and CSA)				
• Rated voltage / rated current / conductor sizes				
- UL/cUL: in V/A / AWG	600 / 20 / 26 ... 12	600 / 30 / 26 ... 12	-- / -- / 26 ... 12	-- / -- / 26 ... 10
- CSA: in V/A / AWG	-- / -- / --			
	8WH1025-0AF00	8WH1025-0AG00		
Dimensions				
• Width/length/cover width in mm	6.2 / 69.9 / 2.2			
• Height (NS 35/7.5 / NS 35/15) in mm	65 / 72.5			
Technical specifications acc. to IEC/DIN VDE				
• Max. load current in A / cross-section in mm ²	28 / 4	36 / 6		
• Rated impulse withstand voltage in kV / pollution degree	6 kV / 3	8 kV / 3		
• Rated insulation voltage U_i in V acc. to IEC 60497-7-1	500			
• Overvoltage category / molded plastic group	III / I			
Connection capacities				
• Flexible with end sleeve, with plastic sleeve in mm ²	0.25 ... 2.5	0.25 ... 4		
• Flexible with end sleeve, without plastic sleeve in mm ²	0.25 ... 2.5	0.25 ... 4		
• Flexible with two-wire connection end sleeve, with plastic sleeve in mm ²	0.5 ... 1.5	0.5 ... 2.5		
• Rigid in mm ²	0.14 ... 4	0.14 ... 6		
Stripped length in mm	9			
Tightening torque in Nm	0.5 ... 0.6	0.6 ... 0.8		
Molded plastic type	PA			
• Flammability Class acc. to UL 94	V0			
Approval data (UL/cUL and CSA)				
• Rated voltage / rated current / conductor sizes				
- UL/cUL: in V/A / AWG	600 / 20 / 26 ... 12	600 / 30 / 26 ... 10		
- CSA: in V/A / AWG	-- / -- / --			







Selection and ordering data

Version	SD	Article No. www.siemens.com/ product?Article No.	Price per PU	PU (UNIT, SET, M)	PS	PG
d						
Terminal size 2.5 mm²						
 <p>8WH1020-0AF00</p>  <p>8WH1025-0AF00</p>		Two-tier terminals, terminal size 2.5 mm² <ul style="list-style-type: none"> •  US • Terminal width 5.2 mm • $I_{max} = 28$ A • $U_{max} = 500$ V • AWG 26 ... 12 • Connection capacity, one conductor <ul style="list-style-type: none"> - Rigid 0.14 ... 4 mm² - Flexible 0.14 ... 4 mm² • Connection capacity, two conductors <ul style="list-style-type: none"> - Rigid 0.14 ... 1.5 mm² - Flexible 0.14 ... 1.5 mm² Versions <ul style="list-style-type: none"> • Gray <ul style="list-style-type: none"> - Without equipotential bonding - With equipotential bonding • Blue <ul style="list-style-type: none"> - Without equipotential bonding 				
		8WH1020-0AF00			1 50 units	1BT
		8WH1025-0AF00			1 50 units	1BT
		8WH1020-0AF01			1 50 units	1BT
 <p>8WH1020-0CF07</p>		PE two-tier terminals, terminal size 2.5 mm² <ul style="list-style-type: none"> •  US • Terminal width 5.2 mm • AWG 26 ... 12 • Connection capacity, one conductor <ul style="list-style-type: none"> - Rigid 0.14 ... 4 mm² - Flexible 0.14 ... 4 mm² • Connection capacity, two conductors <ul style="list-style-type: none"> - Rigid 0.14 ... 1.5 mm² - Flexible 0.14 ... 1.5 mm² • Green-yellow 				
		8WH1020-0CF07			1 50 units	1BT

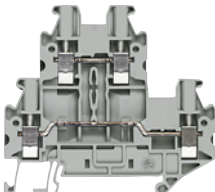
Terminal Blocks

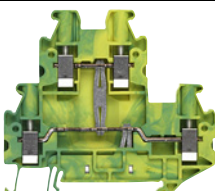
8WH1 Screw Terminals

8WH two-tier terminals

Version	SD	Article No. www.siemens.com/ product?Article No.	Price per PU	PU (UNIT, SET, M)	PS	PG
d						
Terminal size 4 mm²						
 8WH1020-0AG00	Two-tier terminals, terminal size 4 mm² <ul style="list-style-type: none"> •  US • Terminal width 6.2 mm • $I_{max} = 36$ A • $U_{max} = 800$ V • AWG 26 ... 10 • Connection capacity, one conductor <ul style="list-style-type: none"> - Rigid 0.14 ... 6 mm² - Flexible 0.14 ... 6 mm² • Connection capacity, two conductors <ul style="list-style-type: none"> - Rigid 0.14 ... 1.5 mm² - Flexible 0.14 ... 1.5 mm² 					
	Versions <ul style="list-style-type: none"> • Gray <ul style="list-style-type: none"> - Without equipotential bonding - With equipotential bonding • Blue <ul style="list-style-type: none"> - Without equipotential bonding 					
 8WH1020-0CG07	PE two-tier terminals, terminal size 4 mm² <ul style="list-style-type: none"> •  US • Terminal width 6.2 mm • AWG 26 ... 10 • Connection capacity, one conductor <ul style="list-style-type: none"> - Rigid 0.14 ... 6 mm² - Flexible 0.14 ... 6 mm² • Connection capacity, two conductors <ul style="list-style-type: none"> - Rigid 0.14 ... 1.5 mm² - Flexible 0.14 ... 1.5 mm² • Green-yellow 					
	Versions <ul style="list-style-type: none"> • Gray <ul style="list-style-type: none"> - Without equipotential bonding - With equipotential bonding • Blue <ul style="list-style-type: none"> - Without equipotential bonding 					
Accessories						
 8WH9000-1QA00	Covers, for two-tier terminals, for terminal sizes 2.5 ... 4 mm² <ul style="list-style-type: none"> • Width 2.2 mm • Gray 		8WH9000-1QA00 100 100 units 1BT			
 8WH9160-0AA00	Spacer plates, for two-tier terminals, for terminal sizes 2.5 ... 4 mm² <ul style="list-style-type: none"> • Compensates for tier offset if other terminals are mounted side by side • 2.5 mm thick • Gray 		8WH9160-0AA00 100 50 units 1BT			
 8WH9070-6FA00	Compartment partitions, for two-tier terminals, for terminal sizes 2.5 ... 4 mm² <ul style="list-style-type: none"> • For visual and electrical separation of terminal groups • 2 mm thick • Gray 		8WH9070-6FA00 100 50 units 1BT			

For general accessories for 8WH terminal blocks, see [page 14/135](#).

8WH two-tier terminals with isolating function/isolating blade

Overview

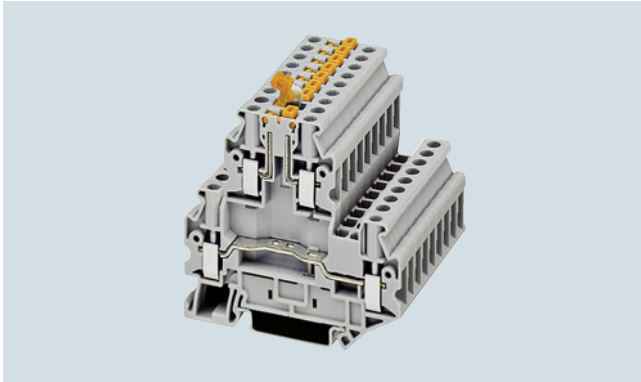

Two-tier terminals with isolating function/isolating blades are also available with the same contour as 8WH1 two-tier terminals.

An increasing number of contact points need to be wired in the same space in the signal wiring. The two voltage levels routed through two separate tiers require 50% less space than equivalent single-tier terminals.

To implement a wide range of wiring tasks, particularly in measuring and control technology, an isolating blade or an isolating plug, a component plug or a fused plug for 5×20 mm glass tube fuses can be used in the standardized separation zone in the upper tier.

The looping of measuring devices is possible over the terminal screws with integrated test socket so that voltage and current measurements can be performed on both tiers without interruption. The tier offset makes access to the lower tier much easier.

The clamping points of two-tier terminals can be inscribed at the front using the labels.

The isolating element must not be replaced under load.

Technical specifications

	8WH1020-6AC00	8WH1020-6AG00
Dimensions		
• Width/length/cover width in mm	6.2 / 69.9 / 2.2	
• Height (NS 35/7.5 / NS 35/15) in mm	65 / 72.5	
Technical specifications acc. to IEC/DIN VDE		
• Max. load current in A / cross-section in mm ²	38 ¹⁾ / 6	
• Rated impulse withstand voltage in kV / pollution degree	6 kV / 3	
• Rated insulation voltage U_i in V acc. to IEC 60497-7-1	500	
• Overvoltage category / molded plastic group	III / I	
Connection capacities		
• Flexible with end sleeve, with plastic sleeve in mm ²	0.25 ... 4	
• Flexible with end sleeve, without plastic sleeve in mm ²	0.25 ... 4	
• Flexible with two-wire connection end sleeve, with plastic sleeve in mm ²	0.5 ... 2.5	
• Rigid in mm ²	0.14 ... 6	
Stripped length in mm	9	
Tightening torque in Nm	0.6 ... 0.8	
Molded plastic type	PA	
• Flammability Class acc. to UL 94	V0	
Approval data (UL/cUL and CSA)		
• Rated voltage / rated current / conductor sizes		
- UL/cUL: in V/A / AWG	600 / 5 / 26 ... 10	
- CSA: in V/A / AWG	-- / -- / --	





¹⁾ Bottom level

Terminal Blocks

8WH1 Screw Terminals

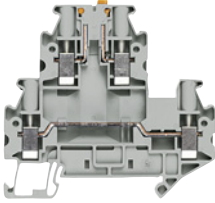
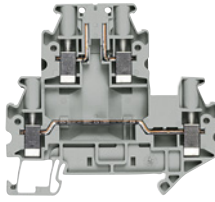
8WH two-tier terminals with isolating function/isolating blade

Selection and ordering data

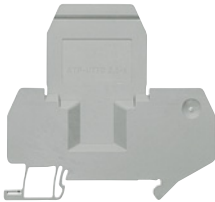
Version	SD	Article No. www.siemens.com/ product?Article No.	Price per PU	PU (UNIT, SET, M)	PS	PG
d						
Terminal size 4 mm²						
 <p>8WH1020-6AC00</p>  <p>8WH1020-6AG00</p>		<p>Two-tier terminals, with isolating function/isolating blade, terminal size 4 mm²</p> <ul style="list-style-type: none"> •  US • Terminal width 6.2 mm • $I_{max} = 38$ A • $U_{max} = 500$ V • AWG 26 ... 10 • Connection capacity, one conductor <ul style="list-style-type: none"> - Rigid 0.14 ... 6 mm² - Flexible 0.14 ... 6 mm² • Connection capacity, two conductors <ul style="list-style-type: none"> - Rigid 0.14 ... 1.5 mm² - Flexible 0.14 ... 1.5 mm² <p>Versions</p> <ul style="list-style-type: none"> • Isolating blades in the upper tier • Isolating terminal in the upper tier 				
		<p>8WH1020-6AC00</p> <p>8WH1020-6AG00</p>		<p>1</p> <p>1</p>	<p>50 units</p> <p>50 units</p>	<p>1BT</p> <p>1BT</p>
Accessories						
 <p>8WH9000-1QA00</p>		<p>Covers, for two-tier terminals, for terminal sizes 2.5 ... 4 mm²</p> <ul style="list-style-type: none"> • Width 2.2 mm • Gray 				
		8WH9000-1QA00		100	100 units	1BT
 <p>8WH9160-0AA00</p>		<p>Spacer plates, for two-tier terminals, for terminal sizes 2.5 ... 4 mm²</p> <ul style="list-style-type: none"> • Compensates for tier offset if other terminals are mounted side by side • 2.5 mm thick • Gray 				
		8WH9160-0AA00		100	50 units	1BT
 <p>8WH9070-6FA00</p>		<p>Compartment partitions, for two-tier terminals, for terminal sizes 2.5 ... 4 mm²</p> <ul style="list-style-type: none"> • For visual and electrical separation of terminal groups • 2 mm thick • Gray 				
		8WH9070-6FA00		100	50 units	1BT

For general accessories for 8WH terminal blocks, see page 14/135.

Overview

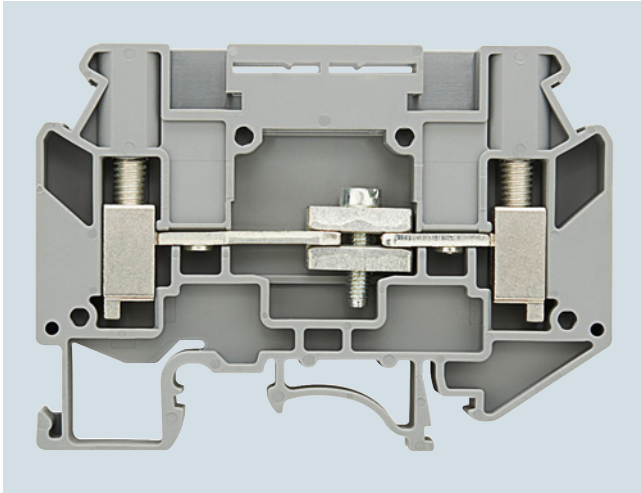

Measuring transformer terminals can be used for testing and isolating circuits without interrupting operation. In this way, they permit easy and transparent maintenance and commissioning.

The isolating and instrument isolating terminals contain an isolating device in the through-type connection. The isolating device permits electrical separation between the input and output of a terminal. Test sockets can be screwed into the front side of the through-type and isolating terminals.

Two adjacent terminals can be connected in parallel with the disconnecting link. The disconnecting link can be operated in any position of the isolating device. Two labels can be snapped on to the side of each terminal at the front.

The isolating element must not be replaced under load.

Instrument set for one transformer

The instrument set for one transformer makes the basic circuit of the transformer terminal blocks clear. This basic circuit is also included in much larger instrument sets, which is extended by adding on equivalent circuits. Links between the basic circuits provide many kinds of testing facilities, parallel outgoing lines to other measuring devices, connection of test equipment, etc.

Instrument set for three transformers

The simplest version of an instrument set for a three-phase circuit consists of three basic circuits strung together without any continuing links.

Instrument set for three transformers with neutral point

The instrument set with a neutral point is an extension of the previous circuit. Four instead of six cables are sufficient for connecting it with the measuring devices. The neutral point is produced on the measuring instruments on the one hand, and using a shortened 8WH9021-0AL00 connection bar on the other.

Note

The 8WH1000-7BH00 through-type terminals and their associated disconnecting links enable terminal sets for current transformers to be configured much more easily. Instead of the 12 isolating or instrument isolating terminals used previously, only 3 instrument isolating terminals and 3 through-type terminals now have to be used.

Instrument set with test facility

This instrument set represents a significant enhancement over previous types. In normal operation, terminals 2, 5 and 8 are closed. For testing a measuring instrument (e.g. a plotter), these terminals are opened and terminals 3, 6 and 9 are closed in order to feed in a test signal. The transformers first have to be short-circuited with the disconnecting links between terminals 1-2, 4-5 and 7-8. Wire jumpers connect terminals 1, 4 and 7 with the neutral point that is formed in terminals 10, 11, 12 and 13 with a shortened jumper 8WH9021-0AL00.

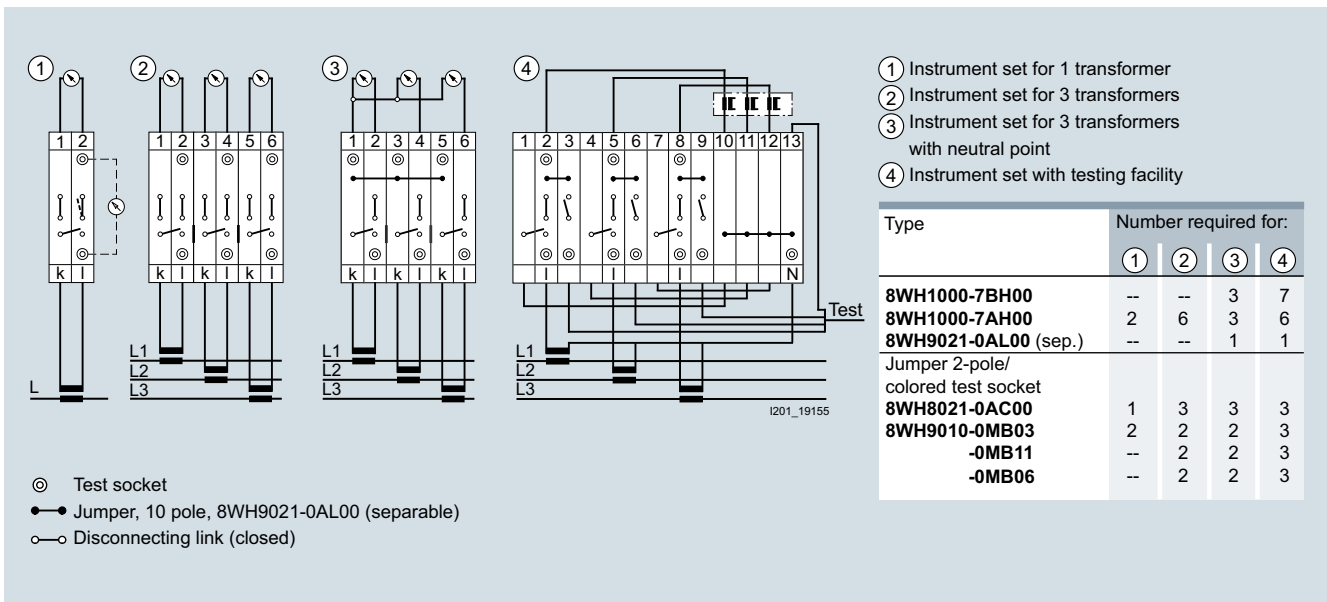

Connection option for measuring transformer terminals (instrument sets)

Terminal Blocks

8WH1 Screw Terminals

8WH measuring transformer terminals







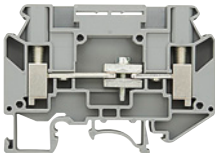
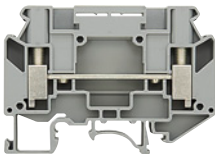

Technical specifications

	8WH1000-7AH00	8WH1000-7BH00
Dimensions		
• Width/length/cover width in mm	8.2 / 66.5 / 2.2	
• Height (NS 35/7.5 / NS 35/15) in mm	48	
Technical specifications acc. to IEC/DIN VDE		
• Max. load current in A / cross-section in mm ²	57/ 10 mm ²	57/ 10 mm ²
• Rated uninterrupted current in A	41	41
• Rated insulation voltage U_i in V acc. to IEC 60497-7-1	500	800
Connection capacities		
• Flexible with end sleeve, with plastic sleeve in mm ²	0.5 ... 6	0.5 ... 6
• Flexible with end sleeve, without plastic sleeve in mm ²	0.5 ... 6	0.5 ... 6
• Flexible with two-wire connection end sleeve, with plastic sleeve in mm ²	0.5 ... 6	0.5 ... 6
• Rigid in mm ²	0.5 ... 10	0.5 ... 10
Stripped length in mm	10	10
Tightening torque in Nm	1.5 ... 1.6	1.5 ... 1.6
Flammability Class acc. to UL 94	V0	

Selection and ordering data

Version	SD	Article No. www.siemens.com/ product?Article No.	Price per PU	PU (UNIT, SET, M)	PS	PG
	d					
General details						
• With thermoplastic insulating body						
• Screw terminals at both ends and 2 recesses for screwing in the test adapters						
Note	Section	Page				
For labeling accessories, see ...	Accessories	14/135				
Terminal size 6 mm²						
						
8WH1000-7AH00						
Measuring transformer isolating terminals, terminal size 6 mm²		8WH1000-7AH00		1 50 units		1BT
• Rated uninterrupted current 41 A						
• Rated insulation voltage 500 V						
• Mounting width 8.2 mm						
• Disconnect slide tightening torque 0.6 ... 0.8 Nm						
						
8WH1000-7BH00						
Measuring transformer through-type terminals, terminal size 6 mm²		8WH1000-7BH00		1 50 units		1BT
• Rated uninterrupted current 41 A						
• Rated insulation voltage 800 V						
• Mounting width 8.2 mm						

8WH measuring transformer terminals

Version	SD	Article No. www.siemens.com/ product?Article No.	Price per PU	PU (UNIT, SET, M)	PS	PG
d						
Accessories						
		Covers, for measuring transformer terminals, size 6 mm²				
8WH9000-3UA00		<ul style="list-style-type: none"> • Width 2.2 mm • Gray 		100	50 units	1BT
		Disconnecting links, 2-pole				
8WH9021-0AC00		<ul style="list-style-type: none"> • For bridging two adjacent terminals • Cannot be used with the bare 8WH9010-0MB12 test socket • Tightening torque: 0.6 ... 0.8 Nm 		1	10 units	1BT
		Connecting combs, 10-pole (separable)				
8WH9021-0AL00		<ul style="list-style-type: none"> • Consisting of connecting wire, spacer sleeves and screws • For bridging terminals, the connecting wire is adjustable • Tightening torque: 0.6 ... 0.8 Nm • Cannot be used with the bare 8WH9010-0MB12 test socket 		1	10 units	1BT
		Test sockets, green				
8WH9010-0MB03		<ul style="list-style-type: none"> • For screwing into the measuring transformer terminals • Tightening torque: 0.6 ... 0.8 Nm • The 8WH9021-0AC00 disconnecting link shall be used for short-circuiting adjacent terminals. 		1	10 units	1BT
		Test sockets, violet				
8WH9010-0MB11		<ul style="list-style-type: none"> • For screwing into the measuring transformer terminals. • Tightening torque: 0.6 ... 0.8 Nm • The 8WH9021-0AC00 disconnecting link shall be used for short-circuiting adjacent terminals. 		1	10 units	1BT
		Test sockets, yellow				
8WH9010-0MB06		<ul style="list-style-type: none"> • For screwing into the measuring transformer terminals. • Tightening torque: 0.6 ... 0.8 Nm • The 8WH9021-0AC00 disconnecting link shall be used for short-circuiting adjacent terminals. 		1	10 units	1BT
		Test sockets, bare				
8WH9010-0MB12		<ul style="list-style-type: none"> • For screwing into the measuring transformer terminals • For simple transformer measurements • Tightening torque: 0.6 ... 0.8 Nm • For tapping with test plug • The 8WH9010-0BC08 short-circuiting plug shall be used for short-circuiting adjacent terminals. 		1	10 units	1BT
		Short-circuiting plugs, 2-pin				
8WH9010-0BC08		<ul style="list-style-type: none"> • For short-circuiting adjacent terminals • For simple transformer measurements • Tightening torque: 0.6 ... 0.8 Nm • Required when the bare 8WH9010-0MB12 test adapter is used in the measuring transformer terminal • Totally insulated • $I_{max} = 20$ A 		1	10 units	1BT

Terminal Blocks

8WH1 Screw Terminals

8WH diode terminals

Overview

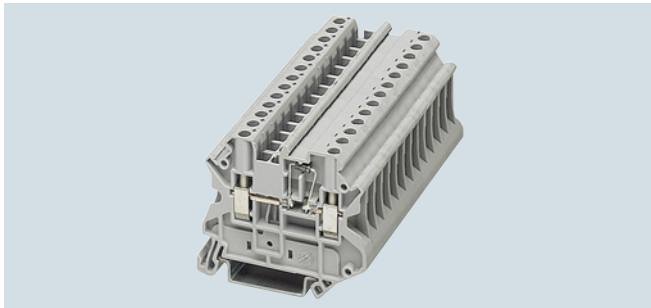

8WH diode terminals can be used to implement many different wiring tasks. The 1N 4007 diode is soldered in from left to right or vice versa as required. The double bridge shaft allows for combination with all standard and function terminals.

The 8WH diode terminals have the same contour as the 8WH isolating, isolating blade and fuse terminals. This has the advantage of enabling consistent inscriptions on all clamping points. Secure electrical and mechanical contact with the support rail is assured by simply snapping the terminals onto the rail.



The clamping points of diode terminals can be inscribed at the front using the labels.

Technical specifications

	8WH1000-6KG00	8WH1000-6LG00
Dimensions		
• Width/length/cover width in mm	6.2 / 57.8 / 2.2	
• Height (NS 35/7.5 / NS 35/15) in mm	47.5 / 55	
Technical specifications acc. to IEC/DIN VDE		
• Max. load current in A ¹⁾ / cross-section in mm ²	-- / 6	
• Rated impulse withstand voltage in kV / pollution degree	8 kV / 3	
• Rated insulation voltage U_i in V acc. to IEC 60497-7-1	800	
• Overvoltage category / molded plastic group	III / I	
Connection capacities		
• Flexible with end sleeve, with plastic sleeve in mm ²	0.25 ... 4	
• Flexible with end sleeve, without plastic sleeve in mm ²	0.25 ... 4	
• Flexible with two-wire connection end sleeve, with plastic sleeve in mm ²	0.5 ... 2.5	
• Rigid in mm ²	0.14 ... 6	
Stripped length in mm	9	
Tightening torque in Nm	0.6 ... 0.8	
Molded plastic type	PA	
• Flammability Class acc. to UL 94	V0	
Approval data (UL/cUL and CSA)		
• Rated voltage / rated current / conductor sizes		
- UL/cUL: in V/A / AWG	600 / 1 / 26 ... 10	600 / 1 / 26 ... 10
- CSA: in V/A / AWG	600 / 1 / 26 ... 10	600 / 1 / 26 ... 10

¹⁾ Maximum current determined by diode. A 1N 4007 diode is integrated, blocking voltage: 1300 V, max. average on-state current: 0.5 A

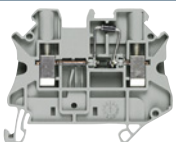
Selection and ordering data

Version	SD	Article No. www.siemens.com/ product?Article No.	Price per PU	PU (UNIT, SET, M)	PS	PG
Terminal size 4 mm²						
		Diode terminals, terminal size 4 mm², gray, C_{UL} US, Ⓢ				
8WH1000-6KG00		<ul style="list-style-type: none"> Terminal width 6.2 mm $I_{max} = 0.5 \text{ A}$, $U_{max} = 800 \text{ V}$ AWG 26 ... 10 Connection capacity, one conductor <ul style="list-style-type: none"> - Rigid 0.14 ... 6 mm², flexible 0.14 ... 6 mm² Connection capacity, two conductors <ul style="list-style-type: none"> - Rigid 0.14 ... 1.5 mm², flexible 0.14 ... 1.5 mm² With integrated diode: 1N 4007 				
Versions						
• Let-through from left to right		8WH1000-6LG00		1 50 units	1BT	
• Let-through from right to left		8WH1000-6KG00		1 50 units	1BT	
Accessories						
		Covers, for diode terminals, for terminal sizes 2.5 ... 4 mm²				
8WH9000-2PA00		<ul style="list-style-type: none"> Width 2.2 mm Gray 				
		Warning covers, for terminal size 4 mm²				
		• Lightning symbol, yellow				
		8WH9063-5BA06		100 50 units	1BT	

For general accessories for 8WH terminal blocks, see [page 14/135](#).

Overview

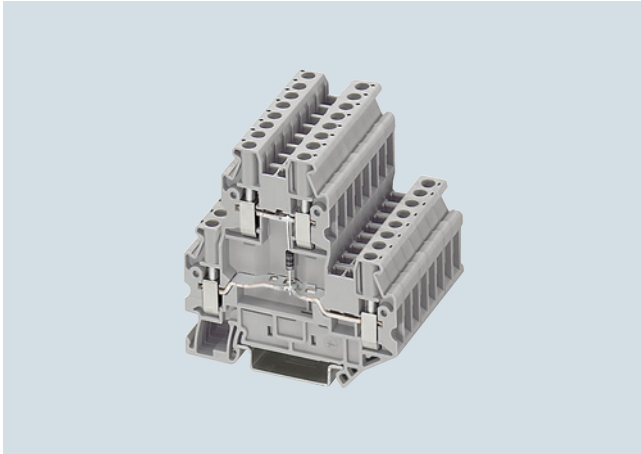

8WH two-tier diode terminals with a width of only 5.2 mm can be used to implement many different wiring tasks. This makes the following possible in the narrowest of spaces:

- Freewheel diode circuits
- Lamp test circuits
- Signaling and fault signaling circuits

The clamping points of the 8WH1 two-tier diode terminals can be inscribed at the front using the labels.

Technical specifications

	8WH1020-5AF00, 8WH1020-5BF00, 8WH1020-5DF00, 8WH1020-5FF00, 8WH1020-5HF00, 8WH1020-5JF30, 8WH1020-5LF00
Dimensions	
• Width/length/cover width in mm	5.2 / 69.9 / 2.2
• Height (NS 35/7.5 / NS 35/15) in mm	65 / 72.5
Technical specifications acc. to IEC/DIN VDE	
• Max. load current in A ¹⁾ / cross-section in mm ²	28 / 4
• Rated impulse withstand voltage in kV / pollution degree	6 kV / 3
• Rated insulation voltage U_i in V acc. to IEC 60497-7-1	500
• Overvoltage category / molded plastic group	III / I
Connection capacities	
• Flexible with end sleeve, with plastic sleeve in mm ²	0.25 ... 2.5
• Flexible with end sleeve, without plastic sleeve in mm ²	0.25 ... 2.5
• Flexible with two-wire connection end sleeve, with plastic sleeve in mm ²	0.5 ... 1.5
• Rigid in mm ²	0.14 ... 4
Stripped length in mm	9
Tightening torque in Nm	0.5 ... 0.6
Molded plastic type	PA
• Flammability Class acc. to UL 94	V0
Approval data (UL/cUL and CSA)	
• Rated voltage / rated current / conductor sizes	
- UL/cUL: in V/A / AWG	-- / -- / --
- CSA: in V/A / AWG	-- / -- / --







¹⁾ Maximum current determined by diode.
 Integrated: diode 1N 4007, blocking voltage: 1300 V
 Max. average on-state current: 0.5 A

Terminal Blocks

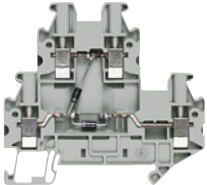

8WH1 Screw Terminals

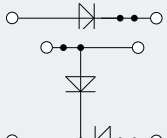
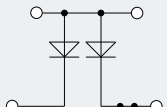
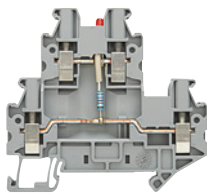
8WH two-tier diode terminals

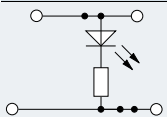
Selection and ordering data

Version	SD	Article No. www.siemens.com/ product?Article No.	Price per PU	PU (UNIT, SET, M)	PS	PG
d						
Terminal size 2.5 mm²						
 <p>8WH1020-5FF0</p> <p>Two-tier diode terminals, terminal size 2.5 mm²</p> <ul style="list-style-type: none"> •  US • Terminal width 5.2 mm • $I_{max} = 28$ A, through the diode 0.5 A • $U_{max} = 500$ V • AWG 26 ... 12 • Connection capacity, one conductor <ul style="list-style-type: none"> - Rigid 0.14 ... 4 mm² - Flexible 0.14 ... 4 mm² • Connection capacity, two conductors <ul style="list-style-type: none"> - Rigid 0.14 ... 1.5 mm² - Flexible 0.14 ... 1.5 mm² • With integrated diode: 1N 4007 • Gray 						
Circuit diagram	Version					
	<ul style="list-style-type: none"> • With one integrated 1N 4007 diode • Let-through from top to bottom 	8WH1020-5AF00		1 50 units	1BT	
	<ul style="list-style-type: none"> • With one integrated 1N 4007 diode • Let-through from bottom to top 	8WH1020-5BF00		1 50 units	1BT	
	<ul style="list-style-type: none"> • With one integrated 1N 4007 diode • Let-through from bottom left to bottom right 	8WH1020-5DF00		1 50 units	1BT	
	<ul style="list-style-type: none"> • With two integrated 1N 4007 diodes • Let-through from top to bottom left and from bottom right to bottom left 	8WH1020-5FF00		1 50 units	1BT	
	<ul style="list-style-type: none"> • With two integrated 1N 4007 diodes • Let-through from top to bottom left and from top to bottom right 	8WH1020-5HF00		1 50 units	1BT	
Two-tier terminals with LED 24 V DC, terminal size 2.5 mm²						
For checking whether voltage is present						
 <p>8WH1020-5JF30</p> <ul style="list-style-type: none"> •  US • Terminal width 5.2 mm • $I_{max} = 28$ A, through the diode 0.5 A • $U_{max} = 500$ V • AWG 26 ... 12 • Connection capacity, one conductor <ul style="list-style-type: none"> - Rigid 0.14 ... 4 mm² - Flexible 0.14 ... 4 mm² • Connection capacity, two conductors <ul style="list-style-type: none"> - Rigid 0.14 ... 1.5 mm² - Flexible 0.14 ... 1.5 mm² • With integrated diode: 1N 4007 • Gray 						
Circuit diagram						
		8WH1020-5JF30		1 50 units	1BT	

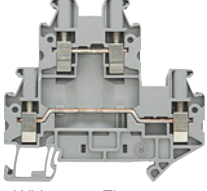
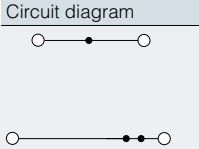
8WH two-tier diode terminals

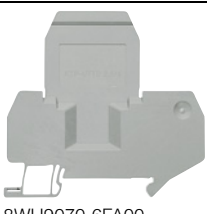
Version	SD	Article No. www.siemens.com/ product?Article No.	Price per PU	PU (UNIT, SET, M)	PS	PG
 <p>8WH1020-5FL00</p> <p>Two-tier terminals for soldering of components, terminal size 2.5 mm² Supplied without components; the appropriate components (resistors, diodes, capacitors, ...) are to be soldered in by user</p> <ul style="list-style-type: none"> • C_{max} 500 μs • Terminal width 5.2 mm • I_{max} = 28 A, through the diode 0.5 A • U_{max} = 500 V • AWG 26 ... 12 • Connection capacity, one conductor <ul style="list-style-type: none"> - Rigid 0.14 ... 4 mm² - Flexible 0.14 ... 4 mm² • Connection capacity, two conductors <ul style="list-style-type: none"> - Rigid 0.14 ... 1.5 mm² - Flexible 0.14 ... 1.5 mm² • With integrated diode: 1N 4007 • Gray <p>Circuit diagram</p> 	d					
		8WH1020-5LF00		1 50 units	1BT	
Accessories						
 <p>8WH9000-1QA00</p> <p>Covers, for two-tier terminals, for terminal sizes 2.5 ... 4 mm²</p> <ul style="list-style-type: none"> • Width 2.2 mm • Gray 		8WH9000-1QA00		100	100 units	1BT
 <p>8WH9160-0AA00</p> <p>Spacer plates, for two-tier terminals, for terminal sizes 2.5 ... 4 mm²</p> <ul style="list-style-type: none"> • Compensates for tier offset if other terminals are mounted side by side • 2.5 mm thick • Gray 		8WH9160-0AA00		100	50 units	1BT
 <p>8WH9070-6FA00</p> <p>Compartment partitions, for two-tier terminals, for terminal sizes 2.5 ... 4 mm²</p> <ul style="list-style-type: none"> • For visual and electrical separation of terminal groups • 2 mm thick • Gray 		8WH9070-6FA00		100	50 units	1BT

For general accessories for 8WH terminal blocks, see page 14/135.

Terminal Blocks

8WH1 Screw Terminals

8WH high-current terminals

Overview

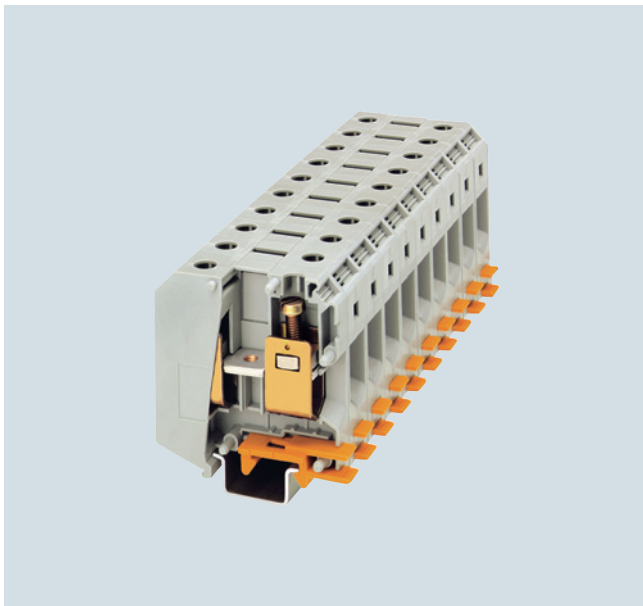

The high-current terminals cover cross-sectional areas from 16 to 240 mm². A reliable cable connection is ensured through effective design measures, such as:

- Three-point centering of the conductor in the prismatic sleeve base
- Low contact resistance of the contact area through grooved surface
- Screw locking through spring-loaded elements
- Terminals enclosed at both ends

The terminals have an enclosed insulating body made of polyamide 6.6.

The terminals are available in gray and blue.

8WH labels must be used at the front for inscription purposes.

For terminals with terminal size up to 95 mm², green-yellow PE/ground conductor terminals are available.

Mounting on support rails acc. to IEC 60715.

Benefits

- Larger connection up to 240 mm²
- The right terminal is always available – whatever the connection functions
- Simple inscription using 8WH standard
- Comprehensive range of accessories available
- Enclosed insulating body made of polyamide 6.6

Design

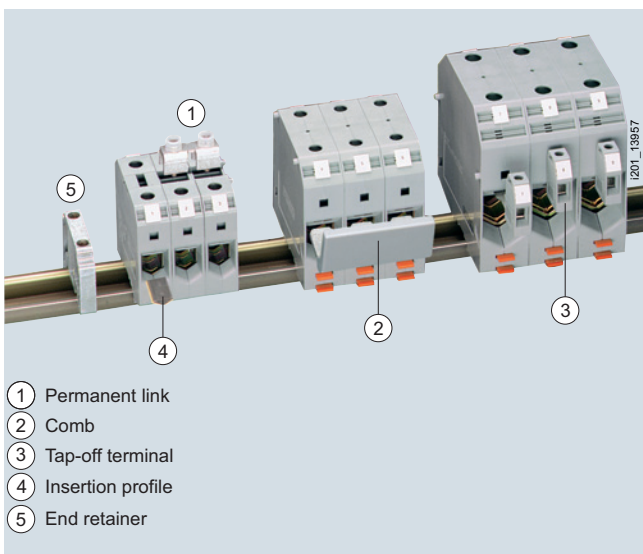

Assembled terminal blocks

Using the 50 mm² terminals, permanent links can be mounted in 2- and 3-pole versions. Combs are required with 95 to 240-mm² terminals.

Technical specifications





	8WH1000-0AN00 8WH1000-0AN01	8WH1000-0CN07	8WH1000-0AQ00 8WH1000-0AQ01
Dimensions			
• Width / length in mm	20 / 70.5		25 / 83
• Height (TS 35/7.5 / TS 35/15 / TS 32) in mm	-- / 83.5 / 81.5		-- / 97.5 / 95.5
Technical specifications acc. to IEC/DIN VDE			
• Max. load current in A / cross-section in mm ²	150 / 50		232 / 95
• Max. cross-section with comb (rigid / flexible) in mm ²	--		95 / 70
• Rated impulse withstand voltage in kV / pollution degree	8 / 3		
• Overvoltage category / molded plastic group	III / I		
Connection capacities			
• Flexible with end sleeves with/without plastic sleeve in mm ²	25 ... 50 / 25 ... 50		35 ... 95 / 35 ... 95
Multi-conductor connection (two conductors of same cross-section)			
• Rigid / flexible in mm ²	10 ... 16 / 10 ... 16		25 ... 35 / 25 ... 35
• Flexible with end sleeve, without plastic sleeve in mm ²	10 ... 16		16 ... 35
Stripped length in mm	24		33
Plug gauge (IEC 60947-1)	B10		B12
Screw thread	M6	--	M8
Tightening torque in Nm	6 ... 8	--	15 ... 20
Clamping point: screw thread / tightening torque in Nm	--	M6 / 6 ... 8	--
Fixing: screw thread / tightening torque in Nm	--	M6 / 6 ... 8	--
Molded plastic type	PA		
• Flammability Class acc. to UL 94	V0		
Approval data (UL/cUL and CSA)			
• Rated voltage / rated current / conductor sizes			
- UL/cUL: V/A/AWG	600 / 150 / 6 ... 0	6 ... 1 / 0	600 / 230 / 2 - 000
- CSA: V/A/AWG	600 / 125 / 6 ... 0	--	600 / 230 / 1 - 000
Support rails / protective conductor busbars	--	see page 14/3, section "Support rails"	--
	8WH1000-0CQ07	8WH1000-0AS00 8WH1000-0AS01	8WH1000-0AU00 8WH1000-0AU01
Dimensions			
• Width / length in mm	25 / 83	31 / 100	36 / 100
• Height (TS 35/7.5 / TS 35/15 / TS 32) in mm	-- / 99 / 96.5	-- / 118.5 / 116	-- / 131.5 / 129.5
Technical specifications acc. to IEC/DIN VDE			
• Max. load current in A / cross-section in mm ²	232 / 95	309 / 150	415 / 240
• Max. cross-section with comb (rigid / flexible) in mm ²	--	150 / 120	240 / 185
• Rated impulse withstand voltage in kV / pollution degree	8 / 3		
• Overvoltage category / molded plastic group	III / I		
Connection capacities			
• Flexible with end sleeves with/without plastic sleeve in mm ²		50 ... 150 / 50 ... 150	70 ... 185 / 70 ... 185
Multi-conductor connection (two conductors of same cross-section)			
• Rigid / flexible in mm ²	25 ... 35 / 25 ... 35	25 ... 50 / 35 ... 50	35 ... 95 / 50 ... 95
• Flexible with end sleeve, without plastic sleeve in mm ²	16 ... 35	25 ... 50	35 ... 50
Stripped length in mm	30	40	
Plug gauge (IEC 60947-1)	B12	B14	B15
Screw thread	--	M10	
Tightening torque in Nm	--	25 ... 30	
Clamping point: screw thread / tightening torque in Nm	M8 / 15 ... 20 (hexagon socket-head screw)	--	--
Fixing: screw thread / tightening torque in Nm	M8 / 15 ... 20 (hexagon socket-head screw)	--	--
Molded plastic type	PA		
• Flammability Class acc. to UL 94	V0		
Approval data (UL/cUL and CSA)			
• Rated voltage / rated current / conductor sizes			
- UL/cUL: V/A/AWG	2 ... 4 / 0	600 / 285 / 2 AWG ... 300 kcmil	600 / 380 / 00 ... 500 kcmil
- CSA: V/A/AWG	2 ... 4 / 0	600 / 275 / 2 AWG ... 300 kcmil	600 / 400 / 0 ... 500 kcmil
Support rails / protective conductor busbars	see page 14/3, section "Support rails"	--	

Terminal Blocks

8WH1 Screw Terminals

8WH high-current terminals





Selection and ordering data

Version	SD	Article No. www.siemens.com/ product?Article No.	Price per PU	PU (UNIT, SET, M)	PS	PG
d						
Terminal size 50 mm²						
		High-current terminal, terminal size 50 mm² <ul style="list-style-type: none">Enclosed at both endsTerminal width 20 mm• ULus• IEC 60947-7-1<ul style="list-style-type: none">Rigid 16 ... 50 mm²Flexible 25 ... 50 mm²AWG 6 ... 0I = 150 AU = 1000 V				
8WH1000-0AN00		Versions <ul style="list-style-type: none">GrayBlue	8WH1000-0AN00	1 10 units	1BT	
			8WH1000-0AN01	1 10 units	1BT	
		PE high-current terminal, terminal size 50 mm² <ul style="list-style-type: none">Green-yellowEnclosed at both endsTerminal width 20 mm• ULus• IEC 60947-7-1<ul style="list-style-type: none">Rigid 16 ... 50 mm²Flexible 25 ... 50 mm²AWG 6 ... 0I = 150 AU = 1000 V				
8WH1000-0CN07			8WH1000-0CN07	1 10 units	1BT	
Terminal size 95 mm²						
		High-current terminal, terminal size 95 mm² <ul style="list-style-type: none">Enclosed at both endsTerminal width 25 mm• ULus• IEC 60947-7-1<ul style="list-style-type: none">Rigid 25 ... 95 mm²Flexible 35 ... 95 mm²AWG 4 ... 000I = 232 AU = 1000 V				
8WH1000-0AQ00		Versions <ul style="list-style-type: none">GrayBlue	8WH1000-0AQ00	1 10 units	1BT	
			8WH1000-0AQ01	1 10 units	1BT	
		PE high-current terminal, terminal size 95 mm² <ul style="list-style-type: none">Green-yellowEnclosed at both endsTerminal width 25 mm• ULus• IEC 60947-7-1<ul style="list-style-type: none">Rigid 25 ... 95 mm²Flexible 35 ... 95 mm²AWG 4 ... 000I = 232 AU = 1000 V				
8WH1000-0CQ07			8WH1000-0CQ07	1 10 units	1BT	
		PE high-current terminals and PEN high-current terminals, terminal size 95 mm², two screw terminals <ul style="list-style-type: none">BareFor I = 232 AMounting width 16 mmTerminal height 63 mmTerminal length 75 mm• For 35 x 15 mm standard mounting rail only	8WA1010-1PQ00	1 5 units	1BT	
8WA1010-1PQ00		Note 8WH accessories do not match this terminal.				

Terminal Blocks

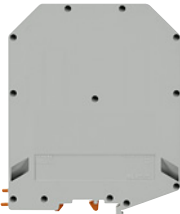
8WH1 Screw Terminals

8WH high-current terminals

Version	SD	Article No. www.siemens.com/ product?Article.No.	Price per PU	PU (UNIT, SET, M)	PS	PG
d						
Terminal size 150 mm²						
		High-current terminal, terminal size 150 mm²				
8WH1000-0AS00		<ul style="list-style-type: none"> Enclosed at both ends Terminal width 31 mm UL US IEC 60947-7-1 <ul style="list-style-type: none"> Rigid 35 ... 150 mm² Flexible 50 ... 150 mm² AWG 2 ... 300 I = 309 A U = 1000 V 				
Versions						
<ul style="list-style-type: none"> Gray Blue 						
		8WH1000-0AS00		1 10 units		1BT
		8WH1000-0AS01		1 10 units		1BT
Terminal size 240 mm²						
		High-current terminal, terminal size 240 mm²				
8WH1000-0AU00		<ul style="list-style-type: none"> Enclosed at both ends Terminal width 36 mm UL US IEC 60947-7-1 <ul style="list-style-type: none"> Rigid 70 ... 240 mm² Flexible 70 ... 240 mm² AWG 00 ... 500 I = 415 A U = 1000 V 				
Versions						
<ul style="list-style-type: none"> Gray Blue 						
		8WH1000-0AU00		1 10 units		1BT
		8WH1000-0AU01		1 10 units		1BT
Accessories						
		Tap-off terminals				
8WH9120-0AA00		<ul style="list-style-type: none"> When wiring a tap-off with a smaller cross-section, observe the overload and short-circuit strength specified in VDE 0100 Part 430 I_{max}: 57 A Cross-section: 10 mm² 				
Versions						
<ul style="list-style-type: none"> For terminal size 50 mm² For terminal size 95 mm² For terminal size 150 ... 240 mm² 						
		8WH9120-0AA00		1 10 units		1BT
		8WH9120-0BA00		1 10 units		1BT
		8WH9120-0CA00		1 10 units		1BT
		Combs				
8WH9020-3AA00		<ul style="list-style-type: none"> Totally insulated Fitted in the clamping sleeve and latched with the terminal enclosure 				
Versions						
<ul style="list-style-type: none"> For terminal size 95 mm², I_{max}: 232 A <ul style="list-style-type: none"> 2-pole 3-pole For terminal size 150 mm², I_{max}: 232 A <ul style="list-style-type: none"> 2-pole 3-pole For terminal size 240 mm², I_{max}: 320 A <ul style="list-style-type: none"> 2-pole 3-pole 						
		8WH9020-3AA00		1 10 units		1BT
		8WH9020-3BA00		1 10 units		1BT
		8WH9020-3CA00		1 10 units		1BT
		8WH9020-3DA00		1 10 units		1BT
		8WH9020-3EA00		1 10 units		1BT
		8WH9020-3FA00		1 10 units		1BT
		Insertion profiles				
8WH9020-3MA00		Evens out the prismatic sleeve base when using flat conductors				
Versions						
<ul style="list-style-type: none"> For terminal size 50 mm² For terminal size 95 mm² For terminal sizes 150 and 240 mm² 						
		8WH9020-3MA00		1 10 units		1BT
		8WH9020-3NA00		1 10 units		1BT
		8WH9020-3PA00		1 10 units		1BT
		Permanent links, for terminal size 50 mm²				
8WH9020-6HC00		<ul style="list-style-type: none"> For cross links Screw heads with insulating collar Remove partition first I_{max} = 150 A 				
Versions						
<ul style="list-style-type: none"> 2-pole 3-pole 						
		8WH9020-6HC00		1 10 units		1BT
		8WH9020-6HD00		1 10 units		1BT

For general accessories for 8WH terminal blocks, see [page 14/135](#).

Terminal Blocks

8WH1 Screw Terminals

8WH shield terminals

Overview

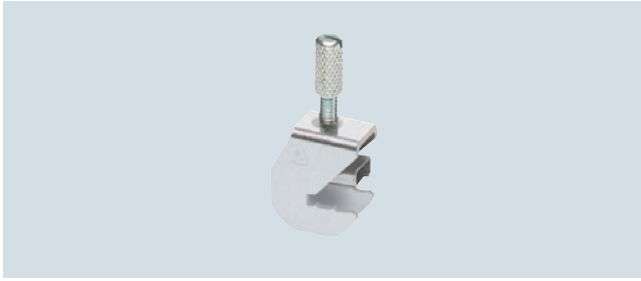

In industrial process engineering, a high interference immunity is required for electrical measuring and control equipment. It is a decisive factor in the availability of industrial equipment. When designing low-interference systems, great importance is placed on cable shielding and the respective shield ground. The critical point is where the cable shield is connected to the enclosure ground. The connection should have a low resistance and a low inductive reactance, while being quick and easy to establish. The shield terminals are ideally suited for this purpose and can be used with all common cable shields.

The effectiveness of cable shields depends to a large extent on the contact quality of the shield connection. The shield terminals have a large, low-impedance contact area with the shield, which reduces the voltage drop across it. Connected at one end only, shields can help reduce only low-frequency, capacitive interference, such as that caused by high-voltage installations. To protect from the much more common inductive interference signals, the cable shield must be connected at both ends.

However, differences in the ground potential can cause a compensating current to flow through the cable shield.

To reduce this interference current, it is advisable to connect the shield at several points along its length. The shorter the spaces between the clamping points, the smaller the compensating currents in the cable shield. In systems where safety is especially important, triaxial shields are used. These consist of two braids that are insulated from each other, with the outer shield connected at both ends and the inner one at only one end. With this arrangement, the equipotential bonding currents and the inductive interference are conducted through the outer shield, and the capacitive interference dissipated through the inner shield.

Depending on the length of the terminal strip, two or more support brackets are fitted, which provide both an electrical and a mechanical connection from the busbar to the support rail and therefore to the enclosure ground. The shield terminal is simply fitted to the busbar after all wires have been connected.

A spring-loaded pressure plate regulates the force applied to the cable to ensure an optimum contact with the busbar at all times.

If the cable shield is to be connected at another point of the control cabinet instead of directly in front of the terminal strip, we recommend using support brackets made of molded plastic.

Technical specifications



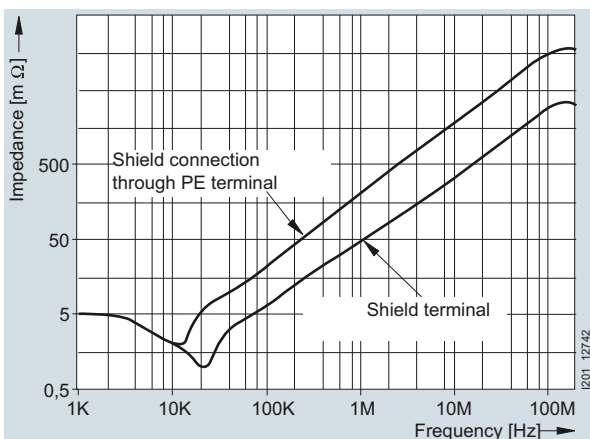

	8WH9130-0KA00	8WH9130-0LA00	8WH9130-0MA00	8WH9130-0NA00	8WH9130-0PA00
Dimensions	See dimensional drawing	See dimensional drawing	See dimensional drawing	See dimensional drawing	See dimensional drawing
Contact resistance in mΩ		< 1			
Connection data					
• Diameter	2 ... 5	3 ... 8	3 ... 14	3 ... 20	20 ... 35
• Tightening torque in Nm	0.4	0.6	0.8	0.8	1.5 ... 1.8

	8WH9130-0AA00	8WH9130-0BA00	8WH9130-0CA00	8WH9130-0DA00
Dimensions	See dimensional drawing	See dimensional drawing	See dimensional drawing	See dimensional drawing
Contact resistance in mΩ	The contact resistance is determined by the mounting area			
Connection data				
• Diameter	3 ... 8	3 ... 14	3 ... 20	20 ... 35
• Tightening torque in Nm	0.6	0.8	0.8	1.5 ... 1.8



Comparison of shield connection through PE terminal and through shield terminal





Selection and ordering data

Version	SD	Article No. www.siemens.com/ product?Article No.	Price per PU	PU (UNIT, SET, M)	PS	PG
General details						
Note <ul style="list-style-type: none"> The shield terminals must not be used for strain relief Support brackets have galvanic connections from the busbar to the support rail or to the mounting block Busbar 10 x 3 mm 						
Terminal diameter 3 ... 8 mm						
Shield terminal, terminal diameter 3 ... 8 mm						
Versions						
 <p>8WH9130-0AA0</p>		<ul style="list-style-type: none"> For direct shield attachment on conductive mounting plate <ul style="list-style-type: none"> Sheet thickness 1 ... 2 mm For busbars 		8WH9130-0AA0		1 10 units 1BT
 <p>8WH9130-0LA00</p>				8WH9130-0LA00		1 10 units 1BT
Terminal diameter 3 ... 14 mm						
Shield terminal, terminal diameter 3 ... 14 mm						
Versions						
 <p>8WH9130-0BA00</p>		<ul style="list-style-type: none"> For direct shield attachment on conductive mounting plate <ul style="list-style-type: none"> Sheet thickness 1 ... 2 mm For busbars 		8WH9130-0BA00		1 10 units 1BT
 <p>8WH9130-0MA00</p>				8WH9130-0MA00		1 10 units 1BT

Terminal Blocks

8WH1 Screw Terminals

8WH shield terminals

Version	SD	Article No. www.siemens.com/ product?Article No.	Price per PU	PU (UNIT, SET, M)	PS	PG
d						
Terminal diameter 3 ... 20 mm						
 <p>8WH9130-0CA00</p>		Shield terminal, terminal diameter 3 ... 20 mm Versions <ul style="list-style-type: none"> • For direct shield attachment on conductive mounting plate - Sheet thickness 1 ... 2 mm • For busbars 		<div style="background-color: #c8e6c9; padding: 10px;"> <p>8WH9130-0CA00</p> <p>1 10 units 1BT</p> <p>8WH9130-0NA00</p> <p>1 10 units 1BT</p> </div>		
 <p>8WH9130-0NA00</p>						
Terminal diameter 20 ... 35 mm						
 <p>8WH9130-0DA00</p>		Shield terminal, terminal diameter 20 ... 35 mm Versions <ul style="list-style-type: none"> • For direct shield attachment on conductive mounting plate - Sheet thickness 1 ... 2 mm • For busbars 		<div style="background-color: #c8e6c9; padding: 10px;"> <p>8WH9130-0DA00</p> <p>1 10 units 1BT</p> <p>8WH9130-0PA00</p> <p>1 10 units 1BT</p> </div>		
 <p>8WH9130-0PA00</p>						

Version	SD	Article No. www.siemens.com/ product?Article No.	Price per PU	PU (UNIT, SET, M)	PS	PG
	d					

Accessories



8WH9140-0DA00



8WH9140-0BA00



8WH9140-0CA00



8WA2842

Support brackets

Versions

- For terminal diameters 8 ... 35 mm, made of molded plastic and conductive connection
 - With retaining screw
 - For 10 x 3 mm busbars
- For terminal diameters 8 ... 20 mm, for mounting rail with clearance of approx. 30 mm to the busbar
 - For 10 x 3 mm busbars
- For terminal diameters 8 ... 20 mm, for mounting rail with clearance of approx. 65 mm to the busbar
 - For 10 x 3 mm busbars

8WH9140-0DA00

1 10 units 1BT

8WH9140-0BA00

1 10 units 1BT

8WH9140-0CA00

1 10 units 1BT

N-busbars, 10 x 3 mm

- Copper, aluminum
- 1000 mm long

8WA2842

1 1 unit 1BT

For general accessories for 8WH terminal blocks, see [page 14/135](#).

Terminal Blocks

8WH1 Screw Terminals

8WH shield terminals

Dimensional drawings

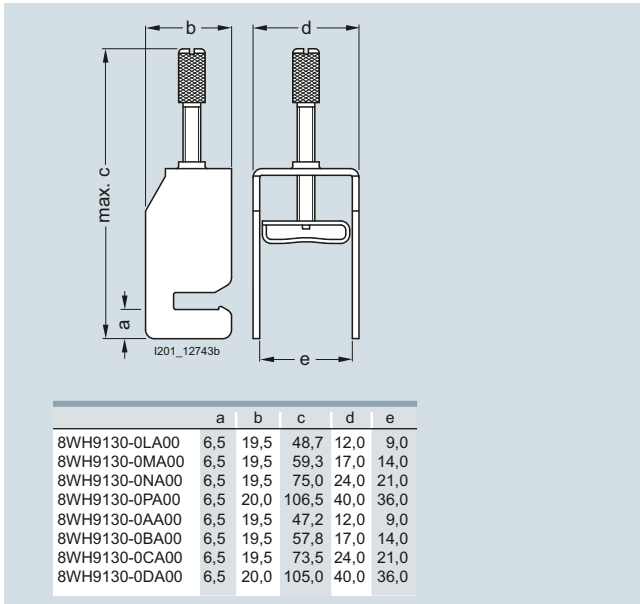

Shield terminals

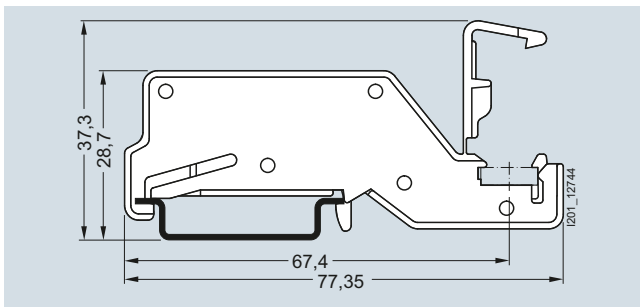

8WH9140-0BA00

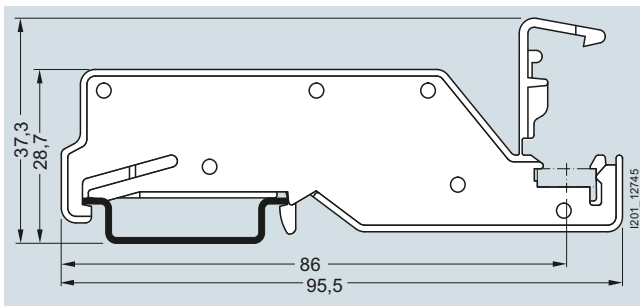

8WH9140-0CA00

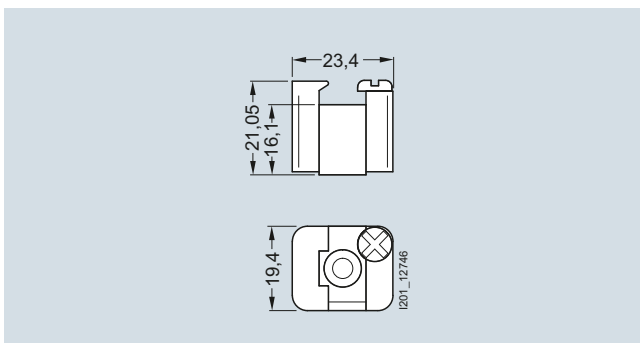

8WH9140-0DA00

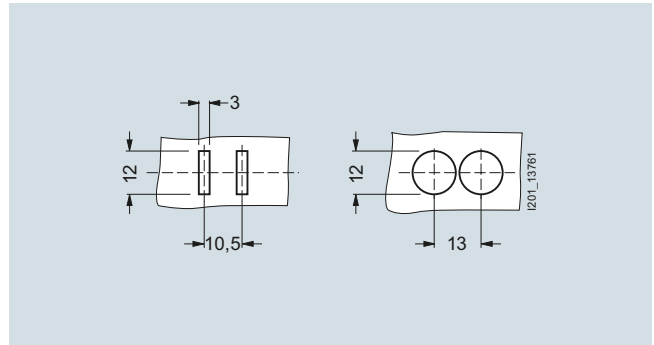

Punching template and drill plan for 8WH9130-0AA00

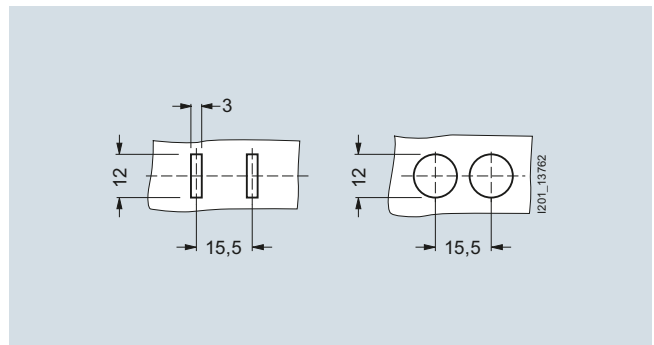

Punching template and drill plan for 8WH9130-0BA00

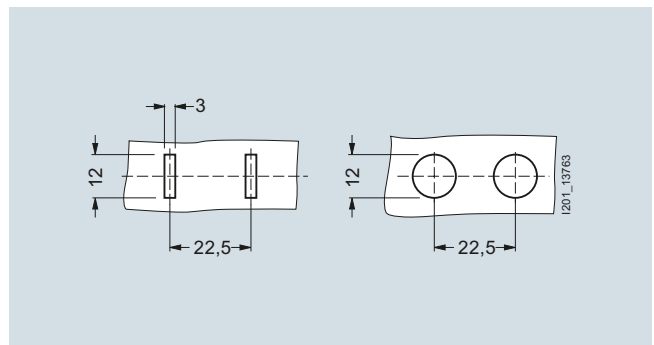

Punching template and drill plan for 8WH9130-0CA00

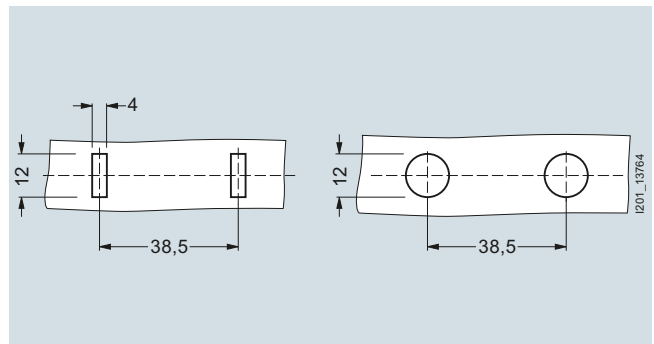

Punching template and drill plan for 8WH9130-0DA00

14

Selection and ordering data

Labeling system for individual inscription



Labeling systems for

- Terminal blocks
- Modular installation devices
- Circuit breakers
- Switch disconnectors

Available from:

Murrplastik Systemtechnik GmbH
Postfach 1143
71570 Oppenweiler
Germany
Telephone: +49 7191-482-0
email: info@murrplastik.de

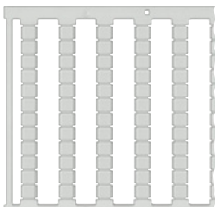
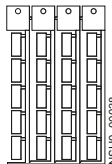
Accessories for labeling system

Version	SD	Article No. www.siemens.com/ product?Article No.	Price per PU	PU (UNIT, SET, M)	PS	PG
d						
 <p>8WH8113-1AA05</p>	Blank labels for 8WH8 terminal blocks					
	Versions					
	<ul style="list-style-type: none"> • Front <ul style="list-style-type: none"> - For 3.5 mm terminal width (WIN 97) - For 4.2 mm terminal width (WIN 97) - For 5.2 and 6.2 mm terminal width (WIN 88) - For 8.2, 10, 12 and 16 mm terminal width (WIN 40) • Flat <ul style="list-style-type: none"> - For 3.5 mm terminal width (WIN 97) - For terminal width of 4.2 mm (WIN 180), 5.2 mm (WIN 182), 6.2 mm (WIN 184), 8.2 mm (WIN 186) and 10 mm (WIN 188) - For 12 and 16 mm terminal width (WIN 46Z) 		8WH8112-0AA05 8WH8112-1AA05 8WH8112-2AA05 8WH8112-4AA05	100 1800 units 1BT 100 1024 units 1BT 100 1400 units 1BT 100 1000 units 1BT		
			8WH8113-0AA05 8WH8113-1AA05 8WH8113-6AA05	100 3000 units 1BT 100 2000 units 1BT 100 1080 units 1BT		
 <p>NSSH0_00038</p>	Snap-on device labels					
	For identification of, e.g. <ul style="list-style-type: none"> • Circuit breakers • Contactors • Control systems 					
	Versions <ul style="list-style-type: none"> • 20 x 7, white, snap-on hooks at side (WIN 95) • 20 x 7, turquoise, snap-on hooks at side (WIN 95) 		8WH8210-0AA55 8WH8210-0AA56	100 340 units 1BT 100 340 units 1BT		
	Adhesive device labels					
	For identification of, e.g. <ul style="list-style-type: none"> • Modular installation devices • Switch disconnectors 					
	Versions <ul style="list-style-type: none"> • 15 x 6 mm, white (WIN 098) • 15 x 6 mm, yellow (WIN 099) • 19 x 8 mm, white (WIN 088) • 19 x 8 mm, yellow (WIN 082) 		8WH8210-0AA35 8WH8210-0AA36 8WH8210-0AA45 8WH8210-0AA46	100 3740 units 1BT 100 3740 units 1BT 100 2700 units 1BT 100 2700 units 1BT		

Note:

The inscription labels can be inscribed with Murrplastik labeling systems or by hand.





The WIN designation facilitates assignment in the inscription software.

Terminal Blocks

Accessories for 8WH Terminal Blocks

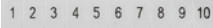
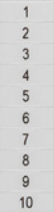
Standard labeling system

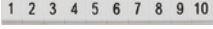
Selection and ordering data

Version	SD	Article No. www.siemens.com/ product?Article.No.	Price per PU	PU (UNIT, SET, M)	PS	PG
Labels, front, for terminal width 4.2 mm and terminal size 1.5 mm² (except 8WH3), printed vertically						
 8WH8120-1AB05						
Labels, front, for terminal width 4.2 mm and terminal size 1.5 mm² (except 8WH3), horizontally printed						
 8WH8140-1AB05						
Labels, front, for terminal width 4.2 mm and terminal size 1.5 mm² (except 8WH3), blank						
 8WH8110-1AA05						
Labels, flat, for terminal width 4.2 mm and terminal size 1.5 mm² (except 8WH3), printed vertically						
 8WH8121-1AB05						
Labels, flat, for terminal width 4.2 mm and terminal size 1.5 mm² (except 8WH3), printed horizontally						
 8WH8141-1AB05						
Labels, flat, for terminal width 4.2 mm and terminal size 1.5 mm² (except 8WH3), blank						
 8WH8111-1AA05						

Terminal Blocks

Accessories for 8WH Terminal Blocks



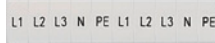





Standard labeling system

Version	SD	Article No. www.siemens.com/ product?Article.No.	Price per PU	PU (UNIT, SET, M)	PS	PG
d						
<div style="display: flex; align-items: center;"> <div style="margin-right: 10px;">  </div> <div> <p>Labels, front, for terminal width 5.2 mm and terminal size 2.5 mm² (8WH3: 1.5 mm²), printed vertically</p> <p>8WH8120-2AB05</p> </div> </div>						
<div style="display: flex; align-items: center;"> <div style="margin-right: 10px;">  </div> <div> <p>8WH8120-2AA15</p> </div> </div>						
<p>Labels, front, for terminal width 5.2 mm and terminal size 2.5 mm² (8WH3: 1.5 mm²), printed horizontally</p> <p>8WH8140-2AB05</p>						

Terminal Blocks

Accessories for 8WH Terminal Blocks

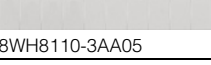
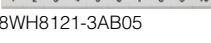
Standard labeling system

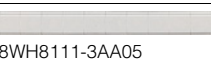
Version	SD	Article No. www.siemens.com/ product?Article No.	Price per PU	PU (UNIT, SET, M)	PS	PG
 8WH8111-2AA05	d	8WH8111-2AA05		100	100 units	1BT
Labels, flat, for terminal width 5.2 mm and terminal size 2.5 mm² (8WH3: 1.5 mm²), blank						
 8WH8120-3AB05		8WH8120-3A□□□		100	100 units	1BT
Labels, front, for terminal width 6.2 mm and terminal size 4 mm² (8WH3: 2.5 mm²), printed vertically						
 8WH8120-3AA15		B05 B15 B25				
 8WH8120-3AA25		B35 B45 B55 B65 B75 B85 C05 A15 A25				
Labels, front, for terminal width 6.2 mm and terminal size 4 mm² (8WH3: 2.5 mm²), printed horizontally		8WH8120-3XA05 -Z and Y01		100	100 units	1BT
 8WH8140-3AB05		8WH8140-3A□□□		100	100 units	1BT
Labels, front, for terminal width 6.2 mm and terminal size 4 mm² (8WH3: 2.5 mm²), printed horizontally						
 8WH8140-3AA05		B05 B15 B25 B35 B45 B55 B65 B75 B85 C05				
Labels, front, for terminal width 6.2 mm and terminal size 4 mm² (8WH3: 2.5 mm²), blank		8WH8140-3XA05 -Z and Y01		100	100 units	1BT
 8WH8110-3AA05		8WH8110-3AA05		100	100 units	1BT
Labels, flat, for terminal width 6.2 mm and terminal size 4 mm² (8WH3: 2.5 mm²), printed vertically						
 8WH8121-3AB05		8WH8121-3A□□□		100	100 units	1BT
Labels, flat, for terminal width 6.2 mm and terminal size 4 mm² (8WH3: 2.5 mm²), printed horizontally						
 8WH8121-3AA05		B05 B15 B25 B35 B45 B55 B65 B75 B85 C05				
Labels, flat, for terminal width 6.2 mm and terminal size 4 mm² (8WH3: 2.5 mm²), printed horizontally		8WH8121-3XA05 -Z and Y01		100	100 units	1BT
 8WH8141-3AB05		8WH8141-3AB05		100	100 units	1BT
Labels, flat, for terminal width 6.2 mm and terminal size 4 mm² (8WH3: 2.5 mm²), printed horizontally						
 8WH8111-3AA05		8WH8141-3XA05 -Z and Y01		100	100 units	1BT
Labels, flat, for terminal width 6.2 mm and terminal size 4 mm² (8WH3: 2.5 mm²), blank		8WH8111-3AA05		100	100 units	1BT

Terminal Blocks

Accessories for 8WH Terminal Blocks









Standard labeling system

Version	SD	Article No. www.siemens.com/ product?Article No.	Price per PU	PU (UNIT, SET, M)	PS	PG
d						
<div style="display: flex; justify-content: space-between; border-bottom: 1px solid black; margin-bottom: 5px;"> 1 2 3 4 5 6 7 8 9 10 </div> 8WH8120-4AB05 <div style="display: flex; justify-content: space-between; border-bottom: 1px solid black; margin-bottom: 5px;"> L1 L2 L3 N PE L1 L2 L3 N PE </div> 8WH8120-4AA15		Labels, front, for terminal width 8.2 mm and terminal size 6 mm², printed vertically Versions <ul style="list-style-type: none"> • Consecutive numbering <ul style="list-style-type: none"> - 1 ... 10 (10x) - 11 ... 20 (10x) - 21 ... 30 (10x) - 31 ... 40 (10x) - 41 ... 50 (10x) - 51 ... 60 (10x) - 61 ... 70 (10x) - 71 ... 80 (10x) - 81 ... 90 (10x) - 91 ... 100 (10x) • L1/L2/L3/N/PE • Special inscription, can only be ordered with the order code -ZY01 				
		8WH8120-4A□□□ ▲▲▲ B05 B15 B25 B35 B45 B55 B65 B75 B85 C05 A15		100	100 units	1BT
		8WH8120-4XA05 -Z and Y01		100	100 units	1BT
<div style="display: flex; justify-content: space-between; border-bottom: 1px solid black; margin-bottom: 5px;"> 1 </div> 8WH8140-4AB05		Labels, front, for terminal width 8.2 mm and terminal size 6 mm², printed horizontally Versions <ul style="list-style-type: none"> • Consecutive numbering <ul style="list-style-type: none"> - 1 ... 10 (10x) - 11 ... 20 (10x) - 21 ... 30 (10x) • Special inscription, can only be ordered with the order code -ZY01 				
		8WH8140-4A□□□ ▲▲▲ B05 B15 B25		100	100 units	1BT
		8WH8140-4XA05 -Z and Y01		100	100 units	1BT
<div style="display: flex; justify-content: space-between; border-bottom: 1px solid black; margin-bottom: 5px;"> 1 2 3 4 5 6 7 8 9 10 </div> 8WH8110-4AA05		Labels, front, for terminal width 8.2 mm and terminal size 6 mm², blank				
		8WH8110-4AA05		100	100 units	1BT
<div style="display: flex; justify-content: space-between; border-bottom: 1px solid black; margin-bottom: 5px;"> 1 2 3 4 5 6 7 8 9 10 </div> 8WH8121-4AB05		Labels, flat, for terminal width 8.2 mm and terminal size 6 mm², printed vertically Versions <ul style="list-style-type: none"> • Consecutive numbering <ul style="list-style-type: none"> - 1 ... 10 (10x) - 11 ... 20 (10x) - 21 ... 30 (10x) • Special inscription, can only be ordered with the order code -ZY01 				
		8WH8121-4A□□□ ▲▲▲ B05 B15 B25		100	100 units	1BT
		8WH8121-4XA05 -Z and Y01		100	100 units	1BT
<div style="display: flex; justify-content: space-between; border-bottom: 1px solid black; margin-bottom: 5px;"> 1 2 3 4 5 6 7 8 9 10 </div> 8WH8141-4AB05		Labels, flat, for terminal width 8.2 mm and terminal size 6 mm², printed horizontally Versions <ul style="list-style-type: none"> • Consecutive numbering <ul style="list-style-type: none"> - 1 ... 10 (10x) - 11 ... 20 (10x) - 21 ... 30 (10x) • Special inscription, can only be ordered with the order code -ZY01 				
		8WH8141-4A□□□ ▲▲▲ B05 B15 B25		100	100 units	1BT
		8WH8141-4XA05 -Z and Y01		100	100 units	1BT
<div style="display: flex; justify-content: space-between; border-bottom: 1px solid black; margin-bottom: 5px;"> 1 2 3 4 5 6 7 8 9 10 </div> 8WH8111-4AA05		Labels, flat, for terminal width 8.2 mm and terminal size 6 mm², blank				
		8WH8111-4AA05		100	100 units	1BT
<div style="display: flex; justify-content: space-between; border-bottom: 1px solid black; margin-bottom: 5px;"> 1 2 3 4 5 6 7 8 9 10 </div> 8WH8120-5AB05 <div style="display: flex; justify-content: space-between; border-bottom: 1px solid black; margin-bottom: 5px;"> L1 L2 L3 N PE L1 L2 L3 N PE </div> 8WH8120-5AA15 <div style="display: flex; justify-content: space-between; border-bottom: 1px solid black; margin-bottom: 5px;"> U V W N φ U V W N φ </div> 8WH8120-5AA25		Labels, front, for terminal width 10 and 12 mm and terminal sizes 10 and 16 mm², printed vertically Versions <ul style="list-style-type: none"> • Consecutive numbering <ul style="list-style-type: none"> - 1 ... 10 (10x) - 11 ... 20 (10x) - 21 ... 30 (10x) - 31 ... 40 (10x) • L1/L2/L3/N/PE • U/V/W/N/grounding • Special inscription, can only be ordered with the order code -ZY01 				
		8WH8120-5A□□□ ▲▲▲ B05 B15 B25 B35 A15 A25		100	100 units	1BT
		8WH8120-5XA05 -Z and Y01		100	100 units	1BT





Terminal Blocks

Accessories for 8WH Terminal Blocks

Standard labeling system

Version	SD	Article No. www.siemens.com/ product?Article No.	Price per PU	PU (UNIT, SET, M)	PS	PG
	d					
 <p>Labels, front, for terminal width 10 and 12 mm and terminal sizes 10 and 16 mm², printed horizontally</p> <p>Versions</p> <ul style="list-style-type: none"> Consecutive numbering <ul style="list-style-type: none"> - 1 ... 10 (10x) - 11 ... 20 (10x) - 21 ... 30 (10x) - 31 ... 40 (10x) Special inscription, can only be ordered with the order code -ZY01 		8WH8140-5A□□□ ▲▲▲ B05 B15 B25 B35		100	100 units	1BT
8WH8140-5AB05		8WH8140-5XA05 -Z and Y01		100	100 units	1BT
 <p>Labels, front, for terminal width 10 and 12 mm and terminal sizes 10 and 16 mm², blank</p>		8WH8110-5AA05		100	100 units	1BT
8WH8110-5AA05						
 <p>Labels, flat, for terminal width 10 and 12 mm and terminal sizes 10 and 16 mm², printed vertically</p> <p>Versions</p> <ul style="list-style-type: none"> Consecutive numbering <ul style="list-style-type: none"> - 1 ... 10 (10x) - 11 ... 20 (10x) - 21 ... 30 (10x) Special inscription, can only be ordered with the order code -ZY01 		8WH8121-5A□□□ ▲▲▲ B05 B15 B25		100	100 units	1BT
8WH8121-5AB05		8WH8121-5XA05 -Z and Y01		100	100 units	1BT
 <p>Labels, flat, for terminal width 10 and 12 mm and terminal sizes 10 and 16 mm², printed horizontally</p> <p>Versions</p> <ul style="list-style-type: none"> Consecutive numbering <ul style="list-style-type: none"> - 1 ... 10 (10x) Special inscription, can only be ordered with the order code -ZY01 		8WH8141-5AB05 8WH8141-5XA05 -Z and Y01		100	100 units	1BT
8WH8141-5AB05				100	100 units	1BT
 <p>Labels, flat, for terminal width 10 and 12 mm and terminal sizes 10 and 16 mm², blank</p>		8WH8111-5AA05		100	100 units	1BT
8WH8111-5AA05						
 <p>Labels, front, for terminal width 16 mm and terminal size 35 mm², printed vertically</p> <p>Versions</p> <ul style="list-style-type: none"> L1/L2/L3/N/PE Special inscription, can only be ordered with the order code -ZY01 		8WH8120-7AA15 8WH8120-7XA05 -Z and Y01		100	50 units	1BT
8WH8120-7AA15				100	100 units	1BT
 <p>Labels, front, for terminal width 16 mm and terminal size 35 mm², printed horizontally, with special inscription Can only be ordered with the order code -ZY01</p>		8WH8140-7XA05 -Z and Y01		100	100 units	1BT
 <p>Labels, front, for terminal width 16 mm and terminal size 35 mm², blank</p>		8WH8110-7AA05		100	100 units	1BT
8WH8110-7AA05						
 <p>Labels, flat, for terminal width 16 mm and terminal size 35 mm², blank</p>		8WH8111-7AA05		100	100 units	1BT

Selection and ordering data

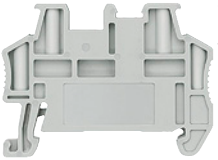
Version	SD	Article No. www.siemens.com/ product?Article No.	Price per PU	PU (UNIT, SET, M)	PS	PG
d						
 Lateral mounting test plugs For individual assembly of test plug connectors Versions <ul style="list-style-type: none"> For terminal width 5.2 mm and terminal size 2.5 mm² 1) 		8WH9010-0EB02		1	10 units	1BT
 Spacer plates For skipping single terminals for individual test adapter assembly Versions <ul style="list-style-type: none"> For terminal width 5.2 mm and terminal size 2.5 mm² 1) 		8WH9010-2BA02		1	10 units	1BT
 Terminal strip markers, for end retainers <ul style="list-style-type: none"> Height-adjustable For quick-fit end retainers Inscription possible with terminal strip marker or two labels, front, for terminal width 10.2 mm Labeling field size: 20 x 8 mm 		8WH9150-1CA00		1	100 units	1BT
 Test adapters <ul style="list-style-type: none"> For 4 mm-Ø test plugs PS and 4 mm-Ø safety test plugs Makes contact in the bridge slot 		8WH9010-0JB00		1	10 units	1BT
 Reducing combs Versions <ul style="list-style-type: none"> For bridging of a through-type terminal, terminal size 2.5 or 4 mm² <ul style="list-style-type: none"> To a through-type terminal, terminal size 1.5 mm² To a through-type terminal, terminal size 6 mm² To a through-type terminal, terminal size 10 mm² To a through-type terminal, terminal size 16 mm² To a through-type terminal, terminal size 35 mm² For connecting a through-type terminal, terminal size 16 mm² <ul style="list-style-type: none"> To a through-type terminal, terminal size 35 mm² Note Not for 8WH1 through-type terminals and 8WH3 insulation displacement terminals.		8WH9020-0CC10 8WH9020-0FC10 8WH9020-0AC10 8WH9020-0BC10 8WH9020-0EC10 8WH9020-0DC10		1	10 units	1BT
 Quick-fit end retainers For inscription with front labels, for terminal width 5.2 mm and terminal strip markers		8WH9150-0CA00		1	50 units	1BT

¹⁾ Except 8WH3

Terminal Blocks

Accessories for 8WH Terminal Blocks

Mounting accessories

Version	SD	Article No. www.siemens.com/ product?Article No.	Price per PU	PU (UNIT, SET, M)	PS	PG	
Screwdrivers							
For actuating the tension spring							
Versions							
<ul style="list-style-type: none"> • 0.4 × 2.5 mm • 0.6 × 3.5 mm • 0.8 × 4.0 mm • 1.0 × 5.5 mm 		8WH9200-0AA00 8WH9200-0AB00 8WH9200-0AC00 8WH9200-0AD00		1 1 1 1	10 units 10 units 10 units 10 units	1BT 1BT 1BT 1BT	
Connecting combs							
Versions		Max. load current I_{max}					
<ul style="list-style-type: none"> • For terminal width 4.2 mm and terminal size 1.5 mm² (except 8WH3) <ul style="list-style-type: none"> - 2-pole - 3-pole - 4-pole - 5-pole - 10-pole - 20-pole 		17.5 A		8WH9020-6AC10 8WH9020-6AD10 8WH9020-6AE10 8WH9020-6AF10 8WH9020-6AL10 8WH9020-6AS10	1 1 1 1 1 1	50 units 50 units 50 units 50 units 10 units 10 units	1BT 1BT 1BT 1BT 1BT 1BT
<ul style="list-style-type: none"> • For terminal width 5.2 mm and terminal size 2.5 mm² (for 8WH3: 1.5 mm²) <ul style="list-style-type: none"> - 2-pole - 3-pole - 4-pole - 5-pole - 10-pole - 20-pole - 50-pole 		24 A		8WH9020-6BC10 8WH9020-6BD10 8WH9020-6BE10 8WH9020-6BF10 8WH9020-6BL10 8WH9020-6BS10 8WH9020-6BT10	1 1 1 1 1 1 1	50 units 50 units 50 units 50 units 10 units 10 units 10 units	1BT 1BT 1BT 1BT 1BT 1BT 1BT
<ul style="list-style-type: none"> • For terminal width 6.2 mm and terminal size 4 mm² (for 8WH3: 2.5 mm²) <ul style="list-style-type: none"> - 2-pole - 3-pole - 4-pole - 5-pole - 10-pole - 20-pole - 50-pole 		32 A		8WH9020-6CC10 8WH9020-6CD10 8WH9020-6CE10 8WH9020-6CF10 8WH9020-6CL10 8WH9020-6CS10 8WH9020-6CT10	1 1 1 1 1 1 1	50 units 50 units 50 units 50 units 10 units 10 units 10 units	1BT 1BT 1BT 1BT 1BT 1BT 1BT
<ul style="list-style-type: none"> • For terminal width 8.2 mm and terminal size 6 mm² <ul style="list-style-type: none"> - 2-pole - 3-pole - 4-pole - 5-pole - 10-pole 		41 A		8WH9020-6DC10 8WH9020-6DD10 8WH9020-6DE10 8WH9020-6DF10 8WH9020-6DL10	1 1 1 1 1	10 units 10 units 10 units 10 units 10 units	1BT 1BT 1BT 1BT 1BT
<ul style="list-style-type: none"> • For terminal width 10 mm and terminal size 10 mm², 2-pole 		57 A		8WH9020-6EC10	1	10 units	1BT
<ul style="list-style-type: none"> • For terminal width 12 mm and terminal size 16 mm², 2-pole 		76 A		8WH9020-6FC10	1	10 units	1BT
<ul style="list-style-type: none"> • For terminal width 16 mm and terminal size 35 mm², 2-pole 		101 A		8WH9020-6GC10	1	10 units	1BT



8WH9200-0AA00







8WH9020-6AC10

Terminal Blocks

Accessories for 8WH Terminal Blocks

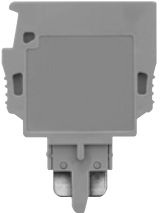
Mounting accessories







Version	SD	Article No. www.siemens.com/ product?Article.No.	Price per PU	PU (UNIT, SET, M)	PS	PG
d						
Plug-in zone connectors, for isolating terminals						
Versions						
 8WH9040-0DB04	<ul style="list-style-type: none"> Isolating plugs - Orange 	8WH9040-0DB04		1	50 units	1BT
 8WH9020-8AB00	<ul style="list-style-type: none"> Through-type connectors - Gray - I_{max}: 16 A 	8WH9020-8AB00		1	50 units	1BT
 8WH9040-3AB08	<ul style="list-style-type: none"> Fused connectors - Black - I_{max}: 6.3 A - For inscription with labels, flat, for terminal width 6.2 mm - G fuses 5 x 20 mm 	8WH9040-3AB08 8WH9040-3CB08 8WH9040-3DB08		1	10 units	1BT
Versions				1	10 units	1BT
<ul style="list-style-type: none"> - With LED display for 12 ... 30 V, 1 ... 2.5 mA - With LED display for 110 ... 250 V, 0.5 ... 2.5 mA - Without LED display 				1	10 units	1BT
Note						
<ul style="list-style-type: none"> The G fuse holders must be selected according to the maximum power loss (heat dissipation) of the G fuse links. Depending on the application and method of installation, the heat rise conditions in closed fuse holders must be tested. Higher ambient temperatures represent an additional load for the fuse links. Hence in such cases of application it is necessary to allow in addition for adjustment of the rated current. 						
 8WH9040-0BB00	<ul style="list-style-type: none"> Component connectors - I_{max}: 6 A, depending on the power loss of the components, max. 1 W for stand-alone arrangement - For inscription with labels, flat, for terminal width 5.2 mm 	8WH9040-0BB00		1	10 units	1BT
Feeder terminals, for N-busbars						
<ul style="list-style-type: none"> 6 x 6 mm and 10 x 3 mm Bare 						
Versions						
 8WA2867/8WA2868/ 8WA2870	<ul style="list-style-type: none"> Rated uninterrupted current 32 A, for connection of up to 4 mm² Rated uninterrupted current 76 A, for connection of up to 25 mm² Rated uninterrupted current 125 A, for connection of up to 35 mm² 	8WA2867 8WA2868 8WA2870		1	50 units	1BT
<ul style="list-style-type: none"> 1						
<ul style="list-style-type: none"> 1						
N-busbars, 10 x 3 mm						
<ul style="list-style-type: none"> Made of copper, tin-plated 1000 mm long 						
 8WA2842		8WA2842		1	1 unit	1BT

Terminal Blocks

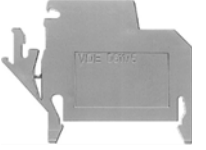
8WA1 Screw Terminals

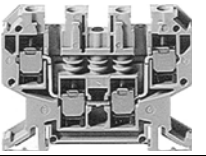
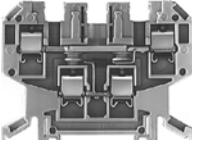
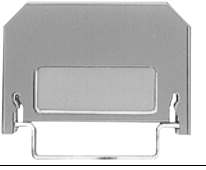
Introduction

Overview

	Devices	Page	Function
	8WA through-type terminals	14/151	Connection of incoming and outgoing cables up to 70 mm ²
	8WA N-conductor isolating and branch terminals	14/157	N-conductor isolating terminals connected to N-busbar 6 × 6 mm
	8WA Insta or three-tier terminals	14/159	These terminals have up to three terminal functions in a single enclosure and may also have an N-conductor isolating terminal connection to an N-busbar 6 × 6 mm. They are optimized for distribution board applications in installation technology
	8WA two-tier terminals	14/161	Compact design of the terminal blocks, in which two connecting wires can be installed
	8WA two-tier terminals with electronic components	14/163	Terminal blocks with integrated diodes
	8WA diode and isolating terminals	14/165	Terminal blocks with integrated diodes or isolation for testing purposes
	8WA terminals for components	14/166	Terminals that enable installation of components in the circuit
	8WA fuse terminals	14/167	Terminals which can be used to protect control circuits, for example
	8WA through-type terminals with soldered and plug-in connection	14/168	Terminals with connection for soldered or plug-in connection
	8WA measuring transformer terminals	14/169	Measuring transformer terminals can be used for testing and isolating circuits in switchboards, control rooms, etc. without interrupting operation

Overview

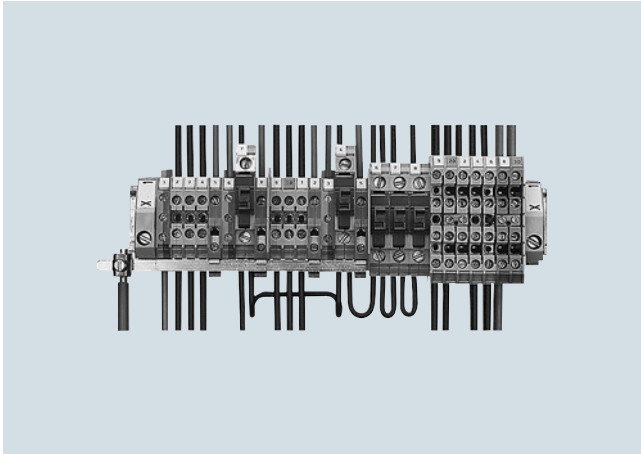

Terminal strips with different terminal blocks: 8WA1011-1DG11 terminal blocks, 8WA1011-1NG31 N-conductor isolating terminals with feeder terminal for N-busbar 6×6 mm, 8WA1011-1PG00 PE terminals, 8WA1011-1SF12 fuse terminals, and various two-tier terminals. The EN 50022-35-compliant standard mounting rail serves as the PE bar.

Terminal blocks are used for the space-saving connection of incoming and outgoing cables in switchboards and distribution boards.

Standards

EN 60664-1,
EN 60999 and
IEC 60 947-7-1 or
IEC 60 947-7-2.

The terminals are finger-safe acc. to IEC 60529 and EN 50274 (except for bare terminals and solder connections). Through-type terminals are resistant to earthquakes according to IEC 60068-2-6.

Rated short-time withstand current

Our screw terminals are able to withstand a rated short-time current corresponding to a current density of 120 A/mm^2 specific to the rated cross-section for one second.

Colored terminal blocks

With colored wiring according to EN 60204-1, the connecting level can also be included in the colored markings:

- Red for control circuits with AC current
- Blue for control circuits with DC current or neutral conductor
- Orange for interlock circuits with AC or DC current which are fed from outside and are live when the main switch is turned off
- Green-yellow through-type terminals for protective conductors (without connection to the support rail)

Design

The terminal blocks are insulated at both ends, with the exception of two-tier, flat and bolt-type terminals, which are insulated on one side only.

The insulating material for terminal sizes up to 70 mm^2 made of thermoplastic, polyamide 6.6.

The materials used are environmentally sustainable: For example, they are cadmium-free and contain no halogens or silicone.

The plastics used are flame-retardant and self-extinguishing according to EN 60695-2-2, VDE 0471, Part 2-2 and UL 94 V-2.

Clamping methods

The terminals are designed so that when the terminal screws are tightened, any tensile stress which occurs causes elastic deformation of the terminal bodies. This compensates for any creepage of the clamping conductor. Deformation of the thread part prevents loosening of the clamping screw, even in the event of heavy mechanical and thermal strain (e.g. vibration stress of 10 g or thermal cycles).

The following clamping methods are used:

- Terminal body with pressure plate for terminal sizes 16, 35 and 70 mm^2
- Strain-relief clamps for terminal sizes 2.5, 4 and 6 mm^2
- Screw with connection disk for fuse terminals and component terminals.

Terminal size

The terminal size corresponds to the nominal cross-section. According to EN 60947-7-1, a finely stranded copper conductor of nominal cross-section can be connected to any clamping point with or without end sleeve.

Mounting

The terminals are snapped onto 35 mm support rails according to IEC 60715 TH35 and secured against movement using end retainers.

A lateral mounting tolerance of 0.2 mm must be maintained between the terminals.

Conductor connection

Except for flat and bolt-type versions, all terminal bodies are designed so that solid, stranded and finely stranded conductors with or without end sleeves (according to DIN 46228) can be securely clamped (please observe cross-section).

Damage to the clamped conductors is prevented by pressure plates or strain-relief clamps. For the conductor cross-sections when 1 or 2 conductors are connected, see [Technical Specifications](#).

Terminal Blocks

8WA1 Screw Terminals

General data on 8WA

Connection of aluminum conductors

Siemens screw terminals are suitable for connecting aluminum conductors provided there is compliance with the normal processing guidelines, i.e. the brushing and greasing of the conductors before connection.

After a few days, the connection should be tightened again for safety reasons.

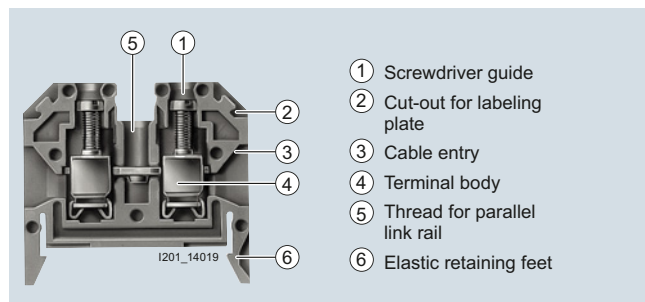

8WA1 through-type terminal with screw terminal at both ends, sectional view

PE and PEN terminals

In switchgear and controlgear systems the support rails for the terminal blocks are frequently used as protective ground busbars. The PE terminals establish the connection to the support rail.

The fact that there is no separate PE busbar means the PE terminals, the insulated main conductor terminals and N-conductor isolating terminals can be arranged according to user requirements. This makes the individual circuits clearly manageable.

The bare 8WA1010-1PH01 PE terminals are primarily used for connecting the shields of shielded cables. They are normally mounted on a standard mounting rail, which is supported by an 8WA1857 insulation carrier and which is equipped with only one PE terminal for connection to the PE conductor.

Accessories

Parallel connection bars

The connection bars are screwed into the terminals from above and allow parallel connection of up to 10 terminals up to terminal size 35 mm². The 10-pole connection bars can be shortened as required. On 70 mm² terminals the connection bars are two-pole.

Barriers

Barriers are yellow in color and project beyond the contours of the terminals. They serve the visual separation of groups of terminals, the electrical isolation of adjacent connection bars and the improvement of the rated insulation voltage.

Insulation plates

8WA1825 and 8WA1822-7TK00 insulation plates can be used with different terminals for providing electrical insulation between connection bars.

Disconnecting links

The 8WA1865 disconnecting links provide a detachable connection between two adjacent terminals of sizes 2.5 to 6 mm².

Covers with lightning symbol

The purpose of these covers is to identify the power input terminals. At the same time, they provide additional touch protection.

End retainers and end labeling plates

End retainers are available in thermoplastic or galvanized and chromated steel. The end labeling plate can be fitted in an 8WA1808 end retainer or, in any of three positions, in an 8WA1805 end retainer.

Technical specifications

Continuous load at increased ambient temperatures

The 8WA1 terminal blocks can withstand an uninterrupted current at ambient temperatures of up to +55 °C. At higher ambient temperatures, a current reduction according to the following formula is required:

$$I_{th2'} = I_{th2} \cdot k$$

I_{th2} = Uninterrupted current according to selection tables, relative to the nominal cross-section

$I_{th2'}$ = Uninterrupted current at increased ambient temperature

k = Derating factor according to table

Ambient temperature	Derating factor k
60 °C	0.94
65 °C	0.88
70 °C	0.82
75 °C	0.75
80 °C	0.67
85 °C	0.58
90 °C	0.47
95 °C	0.33

The highest permissible clamping point overtemperature of 45 K specified in IEC 60947-7-1 is not exceeded at an ambient temperature of up to 100 °C.

Standard mounting rails as PEN rails

Only use Cu busbars.

They must have the same current carrying capacity as protective conductor busbars.

PEN busbars must carry only terminals and no devices.

Standard mounting rails as protective conductor busbars

Protective conductors with a larger cross-section than the protective conductor busbar, and with the same conductivity, can be connected to standard mounting rails that are also protective conductor busbars and carry current only under fault conditions.

Standard mounting rail acc. to EN 50022-35 and IEC 60715 TH35	Material	Type	Max. permissible cross-section of connected protective conductor mm ²
35 × 7.5	Steel	5ST1141	16
	Steel, perforated	5ST1145	16
Similar to 35 × 15	Steel	5ST1142	35
	Steel	--	50
	Copper	8WA7551	150 ¹⁾

¹⁾ With 8WA1010-1PQ00 terminal connection of up to 95 mm² finely stranded or 120 mm² stranded.

Clamping points

Terminal size	Type ¹⁾	Thread diameter of terminal screws	Screwdriver blades acc. to DIN 5264 Form B	Tightening torque = test torque acc. to DIN VDE 0609 and DIN VDE 0611 Nm	Tensile forces acc. to IEC 60947-1 at max. conductor connection N	Stripped length mm
1.5	8WA1011-.SF.., 8WA1011-1EE00	M3.5	0.8 × 4	0.8	40	10
2.5	8WA1..1, 8WA1011-1BF11, 8WA1011-1EF.., 8WA1011-..F..	M2.5 and M3	0.5 × 3	0.5	50	11
		M2.5	0.8 × 4	0.5	50	11
4	8WA1011-..G.., 8WA2867	M3 M3.5	0.8 × 4	0.5 0.8 ... 1	60	11
6	8WA1..2, 8WA1011-..H..	M3.5	0.8 × 4	0.8	80	11
16	8WA1..4, 8WA1011-..K..	M4	0.8 × 4	1.2	100	13
25	8WA2868	M5	1.2 × 6.5	2	135	
35	8WA1..5, 8WA1011-..M.., 8WA2870	M6	1.2 × 6.5	2.5	190	17
				2.5 ... 3		
50	8WH1000-0AN00, 8WH1000-0AN01, 8WH1000-0CN07 8WH1070-0AN00	M6	1.2 × 8	6 ... 8	--	24
		M6	--	3 ... 7	--	6 ... 25
70	8WA1..6	M8	4 hexagon socket-head	6	285	25
95	8WA1010-1PQ00 8WH1000-0AQ00, 8WH1000-0AQ01 8WH1000-0CQ07 8WH1070-0AQ00 8WH1060-0AQ00	M8	6 hexagon socket-head	15 ... 20	--	30
		M8	6 hexagon socket-head	15 ... 20	--	33
		M8	6 hexagon socket-head	15 ... 20	--	30
		M8	--	6 ... 15	--	16 ... 25
		M8	--	25 ... 30	--	29
150	8WH1000-0AS0, 8WH1070-0AS00 8WH1060-0AS00	M10	8 hexagon socket-head	25 ... 30	--	40
		M10	--	10 ... 18	--	10 ... 18
		M10	--	25 ... 30	--	34
240	8WH1000-0AU0, 8WH1060-0AU00	M10	10 hexagon socket-head	30 ... 35	--	40
		M10	--	30 ... 35	--	34

¹⁾ Tightening torque also applicable for accessories (socket, connection bars, etc.).

Terminal Blocks

8WA1 Screw Terminals

General data on 8WA

Rated impulse withstand voltage of terminal blocks

Values dependent on the rated voltage of the \leq rated insulation voltage of terminal block; excerpt from EN 60947-1, table H.1. Terminal blocks are tested acc. to overvoltage category III.

Rated mains voltage (\leq rated insulating voltage of the device) RMS value V AC	Maximum rated operating voltage to ground RMS value V AC or V DC	Preferred values for rated impulse withstand voltage as 1.2/50 μ s pulse Overvoltage category			
		I kV	II kV	III kV	IV kV
--	50	330	500	800	1500
66/115	100	500	800	1500	2500
120/208 127/220	150	800	1500	2500	4000
230/400 277/480	300	1500	2500	4000	6000
400/690	600	2500	4000	6000	8000
1000	1000	4000	6000	8000	12000

Connection

Terminal size mm ²	Type	Smallest conductor cross-section					Largest conductor cross-section				
		Solid mm ²	Stranded mm ²	Finely stranded mm ²	Finely stranded with end sleeve ¹⁾ mm ²	Size	Solid mm ²	Stranded mm ²	Finely stranded mm ²	Finely stranded with end sleeve ¹⁾ mm ²	Size
Single-conductor connection											
1.5	8WA1011-SF . . . , 8WA1011-1EE00	1	--	--	0.75	0.75 ... 10	2.5	--	--	1.5	1.5 ... 10
2.5	8WA1211, 8WA1011-. .F. .	0.25 ²⁾	0.5	0.5	0.5	0.5 ... 10	4	2.5	2.5	2.5	2.5 ... 12 ⁴⁾
	8WA1011-3JF . . .	0.25 ²⁾	0.5	0.5	0.5	0.5 ... 10	4	2.5	2.5	2.5	2.5 ... 7
	8WA1501, 8WA1511, 8WA1011-1EF . . .	0.25 ²⁾	0.5	0.5	0.5	0.5 ... 10	4	2.5	2.5	2.5	1.5 ... 10
4	8WA9200	0.5	1.5	1.5	0.75	0.75 ... 10	6	4	4	4	4
	8WA286. Feeder terminal	1	1.5	1.5	0.75	0.75 ... 10	6	4	4	4	4 ... 12 ⁴⁾
	8WA1011-. .G..	0.5	1.5	0.5	0.75	0.75 ... 10	6	4	4	4	4 ... 12 ⁴⁾
6	8WA1011-1.H..	0.75	1.5	1.5	0.5	0.5 ... 10	10	6	6	6	6 ... 12
	8WA1010-1PH01	0.5	1.5	1.5	0.5	0.5 ... 10	10	6	6	6	6 ... 15
16	8WA1204, 8WA1304, 8WA1011-1BK11	1.5	2.5	2.5	1	1 ... 10 ³⁾	16	25	16	16	16 ... 12
	8WA1604	1.5	2.5	4	1.5	1 ... 10 ³⁾	16	25	16	16	16 ... 12
	8WA1011-1PK00	1.5	2.5	4	1.5	1.5 ... 7 ⁶⁾	16	25	16	16	16 ... 15
	8WA286. Feeder terminal	1.5	2.5	4	2.5	2.5 ... 12	16	16	10	10	10 ... 12
25	8WH1060-0AL00	--	--	4	4	--	--	--	25	25	--
35	8WA1205, 8WA1305, 8WA1011-1BM11	4	10	6	6	6 ... 15	16 ⁵⁾	50	35	35	35 ... 18 ⁷⁾
	8WA1011-1PM00	4	10	10	6	6 ... 15	16 ⁵⁾	50	35	25	25 ... 15
	8JH4114 feeder terminals	6	10	16	6	6 ... 15	16	35	25	25	25 ... 15
	8WA2870	6	10	16	6	6 ... 15	16	35	25	25	25 ... 15
50	8WH1000-0AN00	--	--	10	10	--	--	--	50	50	--
	8WH1000-0AN01	--	--	10	10	--	--	--	50	50	--
	8WH1000-0CN07	--	--	25	25	--	--	--	50	50	--
	8WH1070-0AN00	--	--	6 ¹⁾	--	--	--	--	--	35 ¹⁾	--
	8WH1060-0AN00	--	--	25	25	--	--	--	50	50	--
70	8WA1206	10	16	16	16	16 ... 12 ⁶⁾	95	95	95	--	--
95	8WA1010-1PQ00	--	50	50	--	--	--	95	95	--	--
	8WH1000-0AQ00	--	--	35	35	--	--	--	95	95	--
	8WH1000-0AQ01	--	--	35	35	--	--	--	95	95	--
	8WH1000-0CQ07	--	--	35	35	--	--	--	35	95	--
	8WH1070-0AQ00	--	--	--	16 ¹⁾	--	--	--	--	35 ¹⁾	--
	8WH1060-0AQ00	--	--	35	35	--	--	--	95	95	--
	8WH1000-0AS00, 8WH1000-0AS01	--	--	50	50	--	--	--	150	150	--
8WH1060-0AS00	--	--	50	50	--	--	--	150	150	--	
240	8WA1011-1DU..	--	--	--	--	--	--	240	240	--	--
	8WH1000-0AU00, 8WH1000-0AU01	--	--	70	70	--	--	--	185	185	--
	8WH1060-0AU00	--	--	--	--	--	--	--	--	--	--
	8WH1060-0AU00	--	--	--	--	--	--	--	--	--	--

¹⁾ End sleeves acc. to DIN 46228 Sheet 1 without insulation.
Size corresponds to sleeve nominal size.

²⁾ 0.12/0.25 mm² corresponds to \varnothing 0.4/0.6 mm.

³⁾ For 0.75 mm² conductors, use end sleeves 1 to 10 and press on with insert E1 or PZ 1.5.

⁴⁾ At voltages > 500 V, shorten end sleeves with inserted conductor to 10 mm before pressing on.

⁵⁾ Tested up to 16 mm².

⁶⁾ Fit and press on two end sleeves one after the other (up to stop).

⁷⁾ Voltage reduction to 630 V required.

Terminal size mm ²	Type	Smallest conductor cross-section					Largest conductor cross-section				
		Solid mm ²	Stranded mm ²	Finely stranded mm ²	Finely stranded with end sleeve ¹⁾ mm ²	Size	Solid mm ²	Stranded mm ²	Finely stranded mm ²	Finely stranded with end sleeve ¹⁾ mm ²	Size
Two-wire connection , 2 conductors each of same cross-section; with end sleeves the two rectangular sleeves must be inserted in the same position. 											
1.5	8WA1011-. SF. ., -1EE00	2 × 1	--	--	2 × 0.75	1 ... 10 ²⁾	2 × 2.5	--	--	2 × 1.5	1.5 ... 10
2.5	8WA1211, 8WA1011-. F. .	2 × 0.12 ³⁾	2 × 0.5	2 × 0.5	2 × 0.5 ⁴⁾	0.75 ... 6	2 × 0.75	2 × 0.5	2 × 0.5	2 × 1.5 ⁴⁾	1.5 ... 10
	8WA1501, 8WA1511, 8WA1011-1EF. .	2 × 0.12 ³⁾	2 × 0.5	2 × 0.25	--	--	2 × 0.75	2 × 0.5	2 × 0.75	--	--
4	8WA1011-. G. ., -1DG11	2 × 0.5	2 × 1	2 × 1	2 × 0.5	0.5 × 10	2 × 1.5	2 × 1.5	2 × 1.5	2 × 1.5	1.5 ... 10
	8WA1011-2DG11	2 × 0.5	2 × 1	2 × 1	2 × 0.5	0.5 × 10	2 × 1	2 × 1.5	2 × 1.5	2 × 1	1 ... 10
	8WA1011-6DG11, top	2 × 0.5	2 × 1	2 × 1	2 × 0.5	0.5 × 10	2 × 1.5	2 × 1.5	2 × 1.5	2 × 1	1 ... 10
	8WA1011-6DG11, bottom	2 × 0.5	2 × 1	2 × 1	2 × 0.5	0.5 × 10	2 × 1	2 × 1.5	2 × 1.5	2 × 1	1 ... 10
	8WA1011-1PG00	2 × 0.5	2 × 1	2 × 1	2 × 0.5	0.5 × 10	2 × 1	2 × 1.5	2 × 1.5	2 × 1	1 ... 10
6	8WA1011-1PG11, -1NG01	2 × 0.5	2 × 1	2 × 1	2 × 0.5	0.5 × 10	2 × 1.5	2 × 1.5	2 × 1.5	2 × 1	1 ... 10
	8WA1011-1. H. ., -3DH21	2 × 0.5	2 × 0.75	2 × 0.75	2 × 0.5	0.5 × 10	2 × 1.5	2 × 1.5	2 × 1.5	2 × 1.5	1.5 ... 10
16	8WA1010-1PH01	2 × 0.5	2 × 0.75	2 × 0.75	2 × 0.5	0.5 × 10	2 × 1.5	2 × 1.5	2 × 1.5	2 × 0.75	1 ... 10
	8WA1204, 8WA1304, 8WA1604, 8WA1011-1BK11 8WA1734	2 × 1	2 × 2.5	2 × 2.5	2 × 1	1 ... 10	2 × 4	2 × 4	2 × 4	2 × 4	4 ... 12
35	8WA1205, 8WA1305, 8WA1011-1BM11, 8WA1735	2 × 2.5	--	--	2 × 1.5	1.5 ... 7 ⁵⁾	2 × 4	2 × 4	2 × 4	2 × 4	4 ... 12
	8WA1205, 8WA1305, 8WA1011-1BM11, 8WA1735	2 × 4	2 × 10	2 × 6	2 × 6	6 ... 15	2 × 10	2 × 10	2 × 10	2 × 10	10 ... 15
50	8WH1000-0AN00, 8WH1000-0AN01, 8WH1000-0CN07	2 × 10	2 × 10	2 × 10	2 × 10	--	2 × 35	2 × 35	2 × 35	2 × 35	--
70	8WA1206	2 × 10	2 × 10	2 × 10	2 × 10	10 ... 12 ⁵⁾	2 × 16	2 × 16	2 × 16	2 × 16	16 ... 12 ⁶⁾
95	8WH1000-0AQ00, 8WH1000-0AQ01, 8WH1000-0CQ07	2 × 25	2 × 25	2 × 25	2 × 25	--	2 × 35	2 × 35	2 × 35	2 × 35	--
150	8WH1000-0AS00, 8WH1000-0AS01	2 × 25	2 × 25	2 × 25	2 × 25	--	2 × 50	2 × 50	2 × 50	2 × 50	--
240	8WH1000-0AU00, 8WH1000-0AU01	2 × 35	2 × 35	2 × 35	2 × 35	--	2 × 95	2 × 95	2 × 95	2 × 95	--

1) End sleeves acc. to DIN 46228 Sheet 1 without insulation.
Size corresponds to sleeve nominal size.

2) For 0.75 mm² conductors, use end sleeves 1 to 10 and press on with insert E1 or PZ 1.5 (crimping tool size 1.5).

3) 0.12/0.25 mm² corresponds to Ø 0.4/0.6 mm.

4) With PZ 1.5 (crimping tool size 1.5) on top of one another 

5) Fit and press on two end sleeves one after the other (up to stop).

6) Voltage reduction to 630 V required.

Conductor cross-sections to AWG "American Wire Gauge"

AWG No.	Wire diameter mm	Cross-section mm ²	AWG No.	Wire diameter mm	Cross-section mm ²	AWG No.	Wire diameter mm	Cross-section mm ²
30	0.254	0.051	18	1.024	0.82	6	4.115	13.30
29	0.287	0.065	17	1.151	1.04	5	4.620	16.77
28	0.320	0.081	16	1.290	1.31	4	5.189	21.15
27	0.363	0.102	15	1.450	1.65	3	5.827	26.66
26	0.404	0.128	14	1.628	2.08	2	6.543	33.62
25	0.455	0.163	13	1.829	2.63	1	7.348	42.41
24	0.511	0.205	12	2.052	3.31	1/0	8.252	53.52
23	0.574	0.259	11	2.304	4.17	2/0	9.266	67.43
22	0.643	0.33	10	2.588	5.26	3/0	10.404	85.01
21	0.724	0.41	9	2.906	6.63	4/0	11.684	107.21
20	0.813	0.52	8	3.268	8.37	5/0	--	135.35
19	0.912	0.65	7	3.665	10.55	6/0	--	170.50

Terminal Blocks

8WA1 Screw Terminals

General data on 8WA

® and ⚡ ratings



Terminal size mm ²	Type	CSA rating			UR rating		
		AWG	Rated current I_n A	Rated voltage U_e V	AWG	Rated current I_n A	Rated voltage U_e V
1.5	8WA1011-1SF12	18 ... 14	6.3	600	18 ... 14	6.3	600
	8WA1011-1SF24, -2SF24, -4SF24	14	1	--	14 ... 12	1	AC 240/DC 60
	8WA1011-1SF25, -2SF25, -4SF25	14	2	--	14 ... 12	2	AC 240/DC 60
	8WA1011-1SF26, -2SF26, -4SF26	14	4	--	14 ... 12	4	AC 240/DC 60
	8WA1011-1SF27, -2SF27, -4SF27	14	6	--	14 ... 12	6	AC 240/DC 60
8WA1011-1SF28, -2SF28, -4SF28	14	10	--	14 ... 12	10	AC 240/DC 60	
2.5	8WA1011-1BF21, -1BF22, -1BF23, -1PF11	18 ... 12	25	600	22 ... 12	26	600
	8WA1011-1DF11, -3DF21, -0DF21, -0DF22	18 ... 12	25	600	22 ... 12	26	600
	8WA1011-1NF01, -1NF02	22 ... 12	26	600	22 ... 12	26	600
	8WA1011-3JF..	--	--	--	22 ... 12	26	300
	8WA1011-1PF00, 8WA1011-1PF01	22 ... 12	--	--	22 ... 12	--	--
	8WA1501	22 ... 12	10	300 D	22 ... 12	10	300
4	8WA1011-1PG00, 8WA1011-1PG01	18 ... 10	--	--	18 ... 10	--	--
	8WA1011-1BG11, -1BG21, -1BG22	18 ... 10	40	600	18 ... 10	35	600
	8WA1011-1DG11, -3DG21, -0DG21, -0DG22	18 ... 10	40	600	18 ... 10	35	600
	8WA1011-1NG31, -1NG32	18 ... 10	40	600	18 ... 10	35	600
	8WA1011-1PG11	18 ... 10	40	600	--	--	--
	8WA1011-2BG11, -2DG11	18 ... 10	40	300	18 ... 10	35	600
	8WA1011-6BG11, -6DG11	18 ... 10	40	300	18 ... 10	35	600
	8WA1011-6EG..	--	--	--	18 ... 10	34	300
	8WA9200	18 ... 10	25	300	18 ... 10	26	600
6	8WA1011-1PH00	--	--	--	14 ... 8	--	--
	8WA1011-1BH23, -1PH11	16 ... 10	35	600	14 ... 8	44	600
	8WA1011-1DH11, -3DH21	16 ... 8	35	600	14 ... 8	44	600
	8WA1011-1NH01, -1NH02	14 ... 8	44	600	14 ... 8	44	600
	8WA1011-1MH10, -1MH11, -1MH15	16 ... 10	35/40	600/300 C/D	14 ... 8	44	600/300
	8WA1232	--	--	--	-- ¹⁾	24	600
16	8WA1011-1BK11	14 ... 6	70	600	12 ... 4	79	600
	8WA1011-1PK00	12 ... 4	--	--	12 ... 4	--	--
	8WA1012-1DK10	--	--	--	--	79	600
	8WA1204, 8WA1304	14 ... 6	70	600	12 ... 4	79	600
	8WA1604	--	--	--	12 ... 4	73	300
25	8WH1060-0AL00	6 ... 4	100	600	6 ... 4	85	600
35	8WA1011-1BM11	12 ... 2	100	600	10 ... 1	120	600
	8WA1011-1PM00	10 ... 1	--	--	10 ... 1	--	--
	8WA1205, 8WA1305	12 ... 2	100	600	10 ... 1	120	600
50	8WH1000-0AN00, 8WH1000-0AN01	6 ... 0	125	600	6 ... 0	150	600
	8WH1000-0CN07	--	--	--	6 ... 1	--	--
	8WH1060-0AN00	6 ... 0	125	600	6 ... 0	150	600
70	8WA1012-1DP14	2/0 ... 1	170	600	6 ... 3/0	--	600
	8WA1206	8 ... 1/0	150	600	8 ... 3/0	220	600
95	8WH1000-0AQ00, 8WH1000-0AQ01	1 ... 000	220	600	2 ... 000	230	600
	8WH1000-0CQ07	2 ... 4	--	--	2 ... 4	--	--
	8WH1060-0AQ00	2 ... 000	200	600	2 ... 000	230	600
150	8WH1000-0AS0, 8WH1000-0AS01	2 ... 300 kcmil	275	600	2 ... 300 kcmil	285	600
	8WH1060-0AS00	2 ... 300 kcmil	275	600	2 ... 300 kcmil	285	600
240	8WH1000-0AU00, 8WH1000-0AU01	0 ... 500 kcmil	400	600	0 ... 500 kcmil	380	600
	8WH1000-0AU00	0 ... 500 kcmil	400	600	0 ... 500 kcmil	380	600

¹⁾ Plug-in terminal

Terminal Blocks

8WA1 Screw Terminals

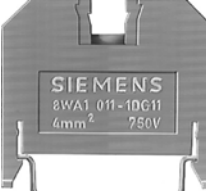



8WA through-type terminals

Version	SD	Article No. www.siemens.com/ product?Article No.	Price per PU	PU (UNIT, SET, M)	PS	PG																																																																																																																														
d																																																																																																																																				
Terminal size 4 mm²																																																																																																																																				
 8WA1011-1DG11	Through-type terminals, terminal size 4 mm² <ul style="list-style-type: none"> Rated uninterrupted current 32 A Rated insulation voltage 800 V Mounting width 6.5 mm Terminal height 30 mm Terminal length 41 mm AWG 18 ... 10 AWG 18 ... 10 																																																																																																																																			
	Versions <ul style="list-style-type: none"> Single terminals <ul style="list-style-type: none"> - Beige - Blue - Red - Orange - Black Terminal blocks <ul style="list-style-type: none"> - Beige, 3-pole, width 19.5 mm - Beige, 10-pole, width 65.5 mm, with inscription 1 ... 10 - Beige, 10-pole, width 65.5 mm, without inscription 																																																																																																																																			
 8WA1011-0DG21	Accessories <table border="1"> <thead> <tr> <th>Accessories</th> <th>Section</th> <th>Page</th> <th></th> <th></th> <th></th> <th></th> </tr> </thead> <tbody> <tr> <td colspan="7">Covers</td> </tr> <tr> <td>• With lightning symbol, for terminal sizes 4 and 6 mm²</td> <td>Accessories</td> <td>14/155</td> <td>8WA1811</td> <td>1</td> <td>50 units</td> <td>1BT</td> </tr> <tr> <td>• White, facility for labeling, for terminal sizes 4 and 6 mm²</td> <td>Accessories</td> <td>14/155</td> <td>8WA1862</td> <td>1</td> <td>50 units</td> <td>1BT</td> </tr> <tr> <td>• For connection bars:</td> <td></td> <td></td> <td></td> <td></td> <td></td> <td></td> </tr> <tr> <td>- Transparent, for terminal sizes 2.5 ... 6 mm²</td> <td>Accessories</td> <td>14/155</td> <td>8WA1822-7AX01</td> <td>1</td> <td>10 units</td> <td>1BT</td> </tr> <tr> <td>- White, facility for labeling, for terminal sizes 2.5 ... 6 mm²</td> <td>Accessories</td> <td>14/155</td> <td>8WA1822-7AX03</td> <td>1</td> <td>10 units</td> <td>1BT</td> </tr> <tr> <td>Jumper, for terminal size 4 mm²</td> <td>Accessories</td> <td>14/155</td> <td>8WA1822-7VG00</td> <td>1</td> <td>50 units</td> <td>1BT</td> </tr> <tr> <td>Disconnecting links</td> <td>Accessories</td> <td>14/156</td> <td>8WA1865</td> <td>1</td> <td>50 units</td> <td>1BT</td> </tr> <tr> <td colspan="7">Note</td> </tr> <tr> <td colspan="7">Between terminals with terminal sizes 2.5 and 6 mm² two 8WH1820 barriers are required.</td> </tr> <tr> <td>• Insulation plates, for terminal sizes 2.5 ... 6 mm²</td> <td>Accessories</td> <td>14/156</td> <td>8WA1825</td> <td>1</td> <td>50 units</td> <td>1BT</td> </tr> <tr> <td>• Connection bars, for terminal size 4 mm²</td> <td></td> <td></td> <td></td> <td></td> <td></td> <td></td> </tr> <tr> <td>- For two terminals</td> <td>Accessories</td> <td>14/156</td> <td>8WA1850</td> <td>1</td> <td>50 units</td> <td>1BT</td> </tr> <tr> <td>- For three terminals</td> <td>Accessories</td> <td>14/156</td> <td>8WA1851</td> <td>1</td> <td>50 units</td> <td>1BT</td> </tr> <tr> <td>- For four terminals</td> <td>Accessories</td> <td>14/156</td> <td>8WA1852</td> <td>1</td> <td>20 units</td> <td>1BT</td> </tr> <tr> <td>- For ten terminals</td> <td>Accessories</td> <td>14/156</td> <td>8WA1853</td> <td>1</td> <td>10 units</td> <td>1BT</td> </tr> <tr> <td>• Barriers, for terminal sizes 1.5 ... 4 mm²</td> <td>Accessories</td> <td>14/156</td> <td>8WA1820</td> <td>1</td> <td>50 units</td> <td>1BT</td> </tr> </tbody> </table>						Accessories	Section	Page					Covers							• With lightning symbol, for terminal sizes 4 and 6 mm ²	Accessories	14/155	8WA1811	1	50 units	1BT	• White, facility for labeling, for terminal sizes 4 and 6 mm ²	Accessories	14/155	8WA1862	1	50 units	1BT	• For connection bars:							- Transparent, for terminal sizes 2.5 ... 6 mm ²	Accessories	14/155	8WA1822-7AX01	1	10 units	1BT	- White, facility for labeling, for terminal sizes 2.5 ... 6 mm ²	Accessories	14/155	8WA1822-7AX03	1	10 units	1BT	Jumper, for terminal size 4 mm ²	Accessories	14/155	8WA1822-7VG00	1	50 units	1BT	Disconnecting links	Accessories	14/156	8WA1865	1	50 units	1BT	Note							Between terminals with terminal sizes 2.5 and 6 mm ² two 8WH1820 barriers are required.							• Insulation plates, for terminal sizes 2.5 ... 6 mm ²	Accessories	14/156	8WA1825	1	50 units	1BT	• Connection bars, for terminal size 4 mm ²							- For two terminals	Accessories	14/156	8WA1850	1	50 units	1BT	- For three terminals	Accessories	14/156	8WA1851	1	50 units	1BT	- For four terminals	Accessories	14/156	8WA1852	1	20 units	1BT	- For ten terminals	Accessories	14/156	8WA1853	1	10 units	1BT	• Barriers, for terminal sizes 1.5 ... 4 mm ²	Accessories	14/156	8WA1820	1	50 units	1BT
	Accessories	Section	Page																																																																																																																																	
Covers																																																																																																																																				
• With lightning symbol, for terminal sizes 4 and 6 mm ²	Accessories	14/155	8WA1811	1	50 units	1BT																																																																																																																														
• White, facility for labeling, for terminal sizes 4 and 6 mm ²	Accessories	14/155	8WA1862	1	50 units	1BT																																																																																																																														
• For connection bars:																																																																																																																																				
- Transparent, for terminal sizes 2.5 ... 6 mm ²	Accessories	14/155	8WA1822-7AX01	1	10 units	1BT																																																																																																																														
- White, facility for labeling, for terminal sizes 2.5 ... 6 mm ²	Accessories	14/155	8WA1822-7AX03	1	10 units	1BT																																																																																																																														
Jumper, for terminal size 4 mm ²	Accessories	14/155	8WA1822-7VG00	1	50 units	1BT																																																																																																																														
Disconnecting links	Accessories	14/156	8WA1865	1	50 units	1BT																																																																																																																														
Note																																																																																																																																				
Between terminals with terminal sizes 2.5 and 6 mm ² two 8WH1820 barriers are required.																																																																																																																																				
• Insulation plates, for terminal sizes 2.5 ... 6 mm ²	Accessories	14/156	8WA1825	1	50 units	1BT																																																																																																																														
• Connection bars, for terminal size 4 mm ²																																																																																																																																				
- For two terminals	Accessories	14/156	8WA1850	1	50 units	1BT																																																																																																																														
- For three terminals	Accessories	14/156	8WA1851	1	50 units	1BT																																																																																																																														
- For four terminals	Accessories	14/156	8WA1852	1	20 units	1BT																																																																																																																														
- For ten terminals	Accessories	14/156	8WA1853	1	10 units	1BT																																																																																																																														
• Barriers, for terminal sizes 1.5 ... 4 mm ²	Accessories	14/156	8WA1820	1	50 units	1BT																																																																																																																														
 8WA1011-1PG01	PE through-type terminals, terminal size 4 mm² <ul style="list-style-type: none"> Green-yellow Mounting width 7.2 mm Terminal height 30 mm Terminal length 51 mm AWG 18 ... 10 																																																																																																																																			
	Versions <ul style="list-style-type: none"> One screw terminal Two screw terminals 																																																																																																																																			
Accessories <table border="1"> <thead> <tr> <th>Accessories</th> <th>Section</th> <th>Page</th> <th></th> <th></th> <th></th> <th></th> </tr> </thead> <tbody> <tr> <td>Barriers, for terminal sizes 1.5 ... 4 mm²</td> <td>Accessories</td> <td>14/156</td> <td>8WA1820</td> <td>1</td> <td>50 units</td> <td>1BT</td> </tr> </tbody> </table>						Accessories	Section	Page					Barriers, for terminal sizes 1.5 ... 4 mm ²	Accessories	14/156	8WA1820	1	50 units	1BT																																																																																																																	
Accessories	Section	Page																																																																																																																																		
Barriers, for terminal sizes 1.5 ... 4 mm ²	Accessories	14/156	8WA1820	1	50 units	1BT																																																																																																																														

Terminal Blocks

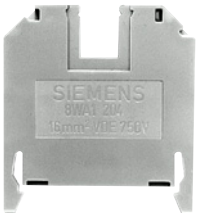
8WA1 Screw Terminals





8WA through-type terminals

Version	SD	Article No. www.siemens.com/ product?Article No.	Price per PU	PU (UNIT, SET, M)	PS	PG
d						
Terminal size 16 mm²						
 8WA1204	Through-type terminals, terminal size 16 mm² <ul style="list-style-type: none"> Rated uninterrupted current 76 A Rated insulation voltage 800 V Mounting width 10 mm Terminal height 38 mm Terminal length 41 mm <ul style="list-style-type: none"> AWG 12 ... 4 AWG 14 ... 6 					
	8WA1204 8WA1011-1BK11 8WA1304					
 8WA1304	Through-type terminals, terminal size 16 mm² <ul style="list-style-type: none"> Rated uninterrupted current 76 A Rated insulation voltage 800 V Mounting width 10 mm Terminal height 38 mm Terminal length 41 mm <ul style="list-style-type: none"> AWG 12 ... 4 AWG 14 ... 6 					
	8WA1812 8WA1892 8WA1822-7AX02 8WA1822-7TK00 8WA1842 8WA1845 8WA1848 8WA1802 8WA1821					
PE through-type terminals and PEN through-type terminals, terminal size 16 mm² <ul style="list-style-type: none"> Green-yellow For I = 76 A Mounting width 12 mm Terminal height 38 mm Terminal length 53 mm Two screw terminals <ul style="list-style-type: none"> AWG 10 ... 1 AWG 12 ... 2 						
8WA1011-1PK00 8WA1821						
Terminal size 35 mm²						
 8WA1205	Through-type terminals, terminal size 35 mm² <ul style="list-style-type: none"> Rated uninterrupted current 125 A Rated insulation voltage 800 V Mounting width 16 mm Terminal height 50 mm Terminal length 53 mm <ul style="list-style-type: none"> AWG 10 ... 1 AWG 12 ... 2 					
	8WA1205 8WA1011-1BM11 8WA1305					
 8WA1305	Through-type terminals, terminal size 35 mm² <ul style="list-style-type: none"> Rated uninterrupted current 125 A Rated insulation voltage 800 V Mounting width 16 mm Terminal height 50 mm Terminal length 53 mm <ul style="list-style-type: none"> AWG 10 ... 1 AWG 12 ... 2 					
	8WA1813 8WA1893 8WA1822-7AX02 8WA1822-7TK00 8WA1828 8WA1803 8WA1804 8WA1823					

Terminal Blocks

8WA1 Screw Terminals

8WA through-type terminals

	Version	SD	Article No. www.siemens.com/ product?Article No.	Price per PU	PU (UNIT, SET, M)	PS	PG
	Disconnecting links Up to 32 A Note Between terminals with terminal sizes 2.5 and 6 mm ² two 8WH1820 barriers are required.	d	8WA1865		1	50 units	1BT
	Insulation plates Versions • For terminal size 2.5 ... 6 mm ² • For terminal sizes 16 and 35 mm ²		8WA1825 8WA1822-7TK00		1 1	50 units 50 units	1BT 1BT
	Connection bars Versions • For terminal size 2.5 mm ² - For two terminals - For three terminals - For four terminals - For ten terminals • For terminal size 4 mm ² - For two terminals - For three terminals - For four terminals - For ten terminals • For terminal size 6 mm ² - For two terminals - For three terminals - For four terminals - For ten terminals • For terminal size 16 mm ² - For two terminals - For three terminals - For four terminals - For ten terminals • For terminal size 35 mm ² - For two terminals - For three terminals - For ten terminals • For terminal size 70 mm ² - For two terminals		8WA1895 8WA1896 8WA1897 8WA1898 8WA1850 8WA1851 8WA1852 8WA1853 8WA1885 8WA1886 8WA1887 8WA1888 8WA1842 8WA1845 8WA1848 8WA1802 8WA1828 8WA1803 8WA1804 8WA1216		1 1 1 1 1 1 1 1 1 1 1 1 1 1 1 1 1 1 1 1 1	50 units 50 units 20 units 10 units 50 units 50 units 20 units 10 units 50 units 50 units 20 units 10 units 20 units 20 units 10 units 10 units 20 units 20 units 10 units	1BT 1BT 1BT 1BT 1BT 1BT 1BT 1BT 1BT 1BT 1BT 1BT 1BT 1BT 1BT 1BT 1BT 1BT 1BT 1BT 1BT
	Barriers Versions • For terminal sizes 1.5 ... 4 mm ² • For terminal sizes 6 and 16 mm ² • For terminal size 35 mm ² • For terminal size 70 mm ²		8WA1820 8WA1821 8WA1823 8WA1824		1 1 1 1	50 units 50 units 25 units 25 units	1BT 1BT 1BT 1BT

8WA1820

Overview

N-conductor isolating terminals permit an insulation test to be performed without disconnecting the neutral conductor according to DIN VDE 0108 and DIN VDE 0100 (Standards for the erection of power installations).

The branch terminals are used for the connection of cables (L), for example for power supplies, to the 6 × 6 mm busbar.

The rated voltage between two branch terminals (1 slide open) is 289 V.

When they are used as shield terminals according to DIN VDE 0160, they provide isolation between the central reference point (shield connection conductor) and the PE conductor.

Selection and ordering data

Version	SD	Article No. www.siemens.com/ product?Article No.	Price per PU	PU (UNIT, SET, M)	PS	PG
	d					
General details <ul style="list-style-type: none"> 1 screw terminal and connection to the neutral conductor bar or 6 × 6 mm busbar acc. to DIN 1761 Insulating body made of blue or beige thermoplastic Enclosed at both ends 						
Note	Section	Page				
For labeling accessories, see ...	Accessories	14/175				

Terminal size 2.5 mm²

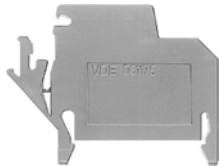

8WA1011-1NF01

N-conductor isolating terminals, terminal size 2.5 mm²

- Blue
- Rated uninterrupted current 24 A
- Rated insulation voltage 500 V
- Mounting width 6 mm
- Terminal height 35 mm
- Terminal length 55 mm
- With built-in test socket in the fixed part of the terminal
- AWG 22 ... 12
- AWG 22 ... 12

Accessories

- N-busbars, 6 × 6 mm
- Label holders

Section	Page
Accessories	14/158
Accessories	14/158

8WA1011-1NF01	1	50 units	1BT
---------------	---	----------	-----

8GF9324-2	1	10 units	1BP
3TX4210-0J	100	100 units	41B

Terminal size 4 mm²

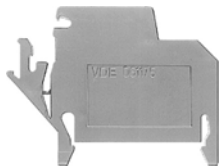

8WA1011-1NG31

N-conductor isolating terminals, terminal size 4 mm²

- Blue
- Rated uninterrupted current 32 A
- Rated insulation voltage 500 V
- Mounting width 6.5 mm
- Terminal height 35 mm
- Terminal length 55 mm
- With built-in test socket in the fixed part of the terminal
- AWG 18 ... 10
- AWG 18 ... 10

Accessories

- Feeder terminals, for N-busbars
- N-busbars, 6 × 6 mm
- Label holders

Section	Page
Accessories	14/158
Accessories	14/158
Accessories	14/158



8WA1011-1NG31	1	50 units	1BT
---------------	---	----------	-----

8WA2867	1	50 units	1BT
8GF9324-2	1	10 units	1BP
3TX4210-0J	100	100 units	41B

Terminal Blocks

8WA1 Screw Terminals

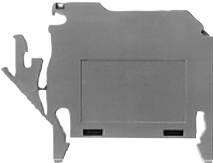
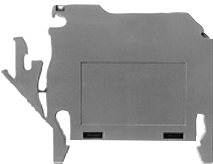
8WA N-conductor isolating and branch terminals

Version	SD	Article No. www.siemens.com/ product?Article.No.	Price per PU	PU (UNIT, SET, M)	PS	PG											
Terminal size 6 mm²																	
 8WA1011-1NH01	N-conductor isolating terminals, terminal size 6 mm² <ul style="list-style-type: none"> Blue Rated uninterrupted current 41 A Rated insulation voltage 500 V Mounting width 8 mm Terminal height 35 mm Terminal length 55 mm With built-in test socket in the fixed part of the terminal AWG 14 ... 8 AWG 14 ... 8 		8WA1011-1NH01		1	50 units 1BT											
	<table border="1"> <thead> <tr> <th>Accessories</th> <th>Section</th> <th>Page</th> </tr> </thead> <tbody> <tr> <td>N-busbars, 6 × 6 mm</td> <td>Accessories</td> <td>14/158</td> </tr> <tr> <td>Label holders</td> <td>Accessories</td> <td>14/158</td> </tr> </tbody> </table>		Accessories	Section	Page	N-busbars, 6 × 6 mm	Accessories	14/158	Label holders	Accessories	14/158	8GF9324-2		1	10 units 1BP		
Accessories	Section	Page															
N-busbars, 6 × 6 mm	Accessories	14/158															
Label holders	Accessories	14/158															
		3TX4210-0J		100	100 units 41B												
Terminal size 16 mm²																	
 8WA1604	N-conductor isolating terminals, terminal size 16 mm² <ul style="list-style-type: none"> Blue Rated uninterrupted current 76 A Rated insulation voltage 500 V Mounting width 10 mm Terminal height 35 mm Terminal length 55 mm AWG 12 ... 4 		8WA1604		1	50 units 1BT											
	<table border="1"> <thead> <tr> <th>Accessories</th> <th>Section</th> <th>Page</th> </tr> </thead> <tbody> <tr> <td>Feeder terminals, for N-busbars</td> <td>Accessories</td> <td>14/158</td> </tr> <tr> <td>N-busbars, 6 × 6 mm</td> <td>Accessories</td> <td>14/158</td> </tr> <tr> <td>Label holders</td> <td>Accessories</td> <td>14/158</td> </tr> </tbody> </table>		Accessories	Section	Page	Feeder terminals, for N-busbars	Accessories	14/158	N-busbars, 6 × 6 mm	Accessories	14/158	Label holders	Accessories	14/158	8WA2868		1
Accessories	Section	Page															
Feeder terminals, for N-busbars	Accessories	14/158															
N-busbars, 6 × 6 mm	Accessories	14/158															
Label holders	Accessories	14/158															
		8GF9324-2		1	10 units 1BP												
		3TX4210-0J		100	100 units 41B												
Accessories																	
 8WA2870 / 868 / 867	Feeder terminals, for N-busbars <ul style="list-style-type: none"> 6 × 6 mm and 10 × 3 mm Bare 																
	<table border="1"> <thead> <tr> <th>Versions</th> </tr> </thead> <tbody> <tr> <td>Rated uninterrupted current 32 A, for connection of up to 4 mm²</td> </tr> <tr> <td>Rated uninterrupted current 76 A, for connection of up to 25 mm²</td> </tr> <tr> <td>Rated uninterrupted current 125 A, for connection of up to 35 mm²</td> </tr> </tbody> </table>		Versions	Rated uninterrupted current 32 A, for connection of up to 4 mm ²	Rated uninterrupted current 76 A, for connection of up to 25 mm ²	Rated uninterrupted current 125 A, for connection of up to 35 mm ²	8WA2867		1	50 units 1BT							
Versions																	
Rated uninterrupted current 32 A, for connection of up to 4 mm ²																	
Rated uninterrupted current 76 A, for connection of up to 25 mm ²																	
Rated uninterrupted current 125 A, for connection of up to 35 mm ²																	
		8WA2868		1	50 units 1BT												
		8WA2870		1	50 units 1BT												
 8GF9324-2	N-busbars, 6 × 6 mm <ul style="list-style-type: none"> Rated uninterrupted current 125 A 1109 mm long For four-field 		8GF9324-2		1	10 units 1BP											
	<table border="1"> <thead> <tr> <th>Note</th> </tr> </thead> <tbody> <tr> <td>Prices apply for orders above € 25.00. For orders below € 25.00 a net processing charge of € 2.50 will be added.</td> </tr> </tbody> </table>		Note	Prices apply for orders above € 25.00. For orders below € 25.00 a net processing charge of € 2.50 will be added.													
Note																	
Prices apply for orders above € 25.00. For orders below € 25.00 a net processing charge of € 2.50 will be added.																	
		Label holders		3TX4210-0J		100 100 units 41B											

Overview

The Insta or three-tier terminals incorporate up to three different terminal functions in one insulating body of 6 mm width. The width of 3 Insta terminals corresponds to the modular width of 18 mm standardized in distribution board assembly. **Tools are required to remove the terminals from the support rail.**

All clamping points for incoming and outgoing cables have a cutout for an 8WA8 8.. inscription label. The protective conductor connections are already marked green-yellow and the neutral conductor connections blue.

The N-busbar has the same position for Insta terminals and N-conductor isolating terminals. This allows, for example, the use of a 16 mm² N-conductor isolating terminal as an infeed for the N-busbar.

8WA1011-3JF16, -3JF17 and -3JF18 allow the N-busbar to be routed with a mounting depth of 42.5 mm.

PE, L, NT Insta terminal

The 8WA1011-3JF20 terminal is the basic version for AC circuits. It comprises:

- Protective conductor connection
- Through-type connection for one phase conductor
- Neutral conductor connection that can be isolated from the 6 × 6 mm N-busbar.

PE, L, N Insta terminal

If no neutral conductor isolation is required, the 8WA1011-3JF17 terminal is used:

- Protective conductor connection
- Through-type connection for one phase conductor
- Through-type connection for the neutral conductor

PE, L, L Insta terminal

Design of 8WA1011-3JF16 terminal as previous version. Instead of the through-type connection for the neutral conductor, a through-type connection for a second phase conductor is fitted.

L, L Insta terminal

The 8WA1011-3JF18 terminal contains two through-type connections for two phase conductors. These are generally used for three-phase outgoing lines.

Selection and ordering data

Version	SD	Article No. www.siemens.com/ product?Article No.	Price per PU	PU (UNIT, SET, M)	PS	PG
	d					
General details						
<ul style="list-style-type: none"> • Thermoplastic insulating body • Screw terminal at both ends • Enclosed at both ends • Neutral terminal, 6 × 6 mm neutral conductor connection 						
Note	Section	Page				
For labeling accessories, see ...	Accessories	14/175				

Terminal size 2.5 mm²

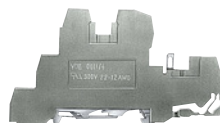

8WA1011-3JF16

Terminal size 2.5 mm²

- Rated uninterrupted current 24 A
- Rated insulation voltage
 - 400 V between phase conductors
 - 250 V between phase and protective conductors and for neutral isolating distance
- Mounting width 6 mm
- Terminal height 42.5 mm
- Terminal length 87 mm
- Screw terminals at both ends
- AWG 22 ... 12

Circuit diagram

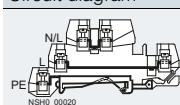

Type
PE, L, L

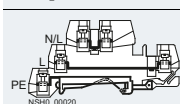

Type
PE, L, N

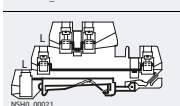

Type
L, L

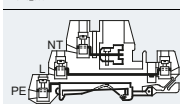

Type
PE, L, NT

Accessories

Barriers, for Insta terminals, terminal size 2.5 mm² and measuring transformer terminals, terminal size 6 mm²

Section
Accessories

Page
14/160

8WA1011-3JF16	1	50 units	1BT
8WA1011-3JF17	1	50 units	1BT
8WA1011-3JF18	1	50 units	1BT
8WA1011-3JF20	1	50 units	1BT
8WA1822-7TH00	1	50 units	1BT

Terminal Blocks

8WA1 Screw Terminals

8WA Insta or three-tier terminals

Version	SD	Article No. www.siemens.com/ product?Article No.	Price per PU	PU (UNIT, SET, M)	PS	PG
Accessories						
Covers Up to three terminals side-by-side						
Versions						
<ul style="list-style-type: none"> • With lightning symbol, for terminal sizes 4 and 6 mm² • White, facility for labeling, for terminal sizes 4 and 6 mm² • For connection bars, for terminal sizes 2.5 ... 6 mm² <ul style="list-style-type: none"> - Transparent - White 		8WA1811 8WA1862 8WA1822-7AX01 8WA1822-7AX03		1 50 units 1BT 1 50 units 1BT 1 10 units 1BT 1 10 units 1BT		
Feeder terminals, for N-busbars						
<ul style="list-style-type: none"> • 6 × 6 mm and 10 × 3 mm • Bare 						
Versions						
<ul style="list-style-type: none"> • Connection up to 4 mm² • Connection up to 25 mm² • Connection up to 35 mm² 		8WA2867 8WA2868 8WA2870		1 50 units 1BT 1 50 units 1BT 1 50 units 1BT		
End retainers, thermoplastic Width 10 mm						
8WA1808						
Terminal strip labels						
<ul style="list-style-type: none"> • Suitable for 8WA1808 end retainer • Blank (WIN 67) 		8WA8212-0AA65		100 380 units 1BT		
Insulation carriers, for mounting insulated support rails						
8WA1857						
Labels, blank						
<ul style="list-style-type: none"> • Suitable for plotting • Label size 5 × 7 mm (WIN 68) 		8WA8348-2AY		100 136 units 1BT		
N-busbars, 6 × 6 mm						
<ul style="list-style-type: none"> • Rated uninterrupted current 125 A • 1109 mm long • For four-field 		8GF9324-2		1 10 units 1BP		
Note						
Prices apply for orders above € 25.00. For orders below € 25.00 a net processing charge of € 2.50 will be added.						
Connection bars, for Insta terminals						
Versions						
<ul style="list-style-type: none"> • For two terminals • For three terminals • For ten terminals 		8WA1822-7VF02 8WA1822-7VF03 8WA1822-7VF10		1 50 units 1BT 1 50 units 1BT 1 10 units 1BT		
Barriers, for Insta terminals, terminal size 2.5 mm² and measuring transformer terminals, terminal size 6 mm²						
		8WA1822-7TH00		1 50 units 1BT		

Overview

Two-tier terminals are a compact form of the terminal blocks. They are therefore open on one side. They can contain two connecting cables with two connections each or they can be laid out as terminal blocks with four connections on the same potential.

An advantage is the standardized front for mounting, bridging and labeling.

Technical specifications

	Rated voltage	
	AC	DC
Between connection bars		
• With insulation plate	400 V	450 V
• With end plate or barrier	800 V	900 V
• With disconnecting link opened	500 V	600 V
For alternately bent soldering tags	400 V	450 V
For adjacent terminals with soldering tags and insulated plugs	250 V	300 V

Selection and ordering data

Version	SD	Article No. www.siemens.com/ product?Article No.	Price per PU	PU (UNIT, SET, M)	PS	PG
	d					

General details

- Thermoplastic insulating body
- Screw terminal at both ends

Note	Section	Page
For labeling accessories, see ...	Accessories	14/175

Terminal size 4 mm²

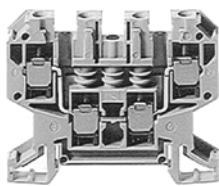

8WA1011-6DG11

Two-tier terminals, terminal size 4 mm²

- Rated uninterrupted current 32 A
- Rated insulation voltage 690 V (with end plate 800 V)
- Mounting width 6.5 mm
- Terminal height 45 mm
- Terminal length 64 mm
- AWG 18 ... 10
- AWG 18 ... 10

Versions

- Beige
 - 1-pole
 - 2-pole, with two isolated connections
- Blue
 - 1-pole
 - 2-pole, with two isolated connections

Accessories	Section	Page
Covers		
• With lightning symbol, for terminal sizes 4 and 6 mm ²	Accessories	14/162
• White, facility for labeling, for terminal sizes 4 and 6 mm ²	Accessories	14/162
• For connection bars, for terminal sizes 2.5 ... 6 mm ² , transparent	Accessories	14/162
Jumpers		
• For upper tier of 2-pole terminals	Accessories	14/162
• For lower tier of 1 and 2-pole terminals	Accessories	14/162
End plates	Accessories	14/162
Disconnecting links	Accessories	14/162
Insulation plates		
• For upper tier of 2-pole terminals	Accessories	14/162
• For lower tier of 1 and 2-pole terminals	Accessories	14/162
Connection bars		
• For upper tier of 2-pole terminals		
- For two terminals	Accessories	14/162
- For three terminals	Accessories	14/162
- For four terminals	Accessories	14/162
- For ten terminals	Accessories	14/162
• For lower tier of 1 and 2-pole terminals		
- For two terminals	Accessories	14/162
- For ten terminals	Accessories	14/162
Barriers	Accessories	14/162

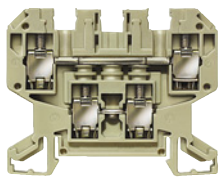





8WA1011-2DG11

8WA1011-6DG11		1	50 units	1BT
8WA1011-2DG11		1	50 units	1BT
8WA1011-6BG11		1	50 units	1BT
8WA1011-2BG11		1	50 units	1BT
8WA1811		1	50 units	1BT
8WA1862		1	50 units	1BT
8WA1822-7AX01		1	10 units	1BT
8WA1822-7VG00		1	50 units	1BT
8WA1822-7VG01		1	50 units	1BT
8WA1817		1	50 units	1BT
8WA1865		1	50 units	1BT
8WA1825		1	50 units	1BT
8WA1825		1	50 units	1BT
8WA1850		1	50 units	1BT
8WA1851		1	50 units	1BT
8WA1852		1	20 units	1BT
8WA1853		1	10 units	1BT
8WA1835		1	50 units	1BT
8WA1838		1	10 units	1BT
8WA1823		1	25 units	1BT

Terminal Blocks

8WA1 Screw Terminals

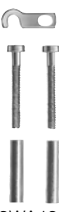
8WA two-tier terminals

Version	SD	Article No. www.siemens.com/ product?Article No.	Price per PU	PU (UNIT, SET, M)	PS	PG
Accessories						
Covers						
Versions						
		• With lightning symbol, for terminal sizes 4 and 6 mm ²	8WA1811	1 50 units	1BT	
8WA1811						
		• White, facility for labeling, for terminal sizes 4 and 6 mm ²	8WA1862	1 50 units	1BT	
8WA1862						
		• For connection bars, for terminal sizes 2.5 ... 6 mm ² , transparent	8WA1822-7AX01	1 10 units	1BT	
8WA1822-7AX01						
Jumpers						
<ul style="list-style-type: none"> • For connection bars • For terminal size 4 mm² 						
Versions						
<ul style="list-style-type: none"> • For upper tier of 2-pole terminals • For lower tier of 1 and 2-pole terminals 						
			8WA1822-7VG00	1 50 units	1BT	
			8WA1822-7VG01	1 50 units	1BT	
End plates, for two-tier terminals						
			8WA1817	1 50 units	1BT	
Disconnecting links						
For upper tier of 2-pole terminals						
Note						
The terminals must be fitted with end plates and must be fitted with the end plates facing each other.						
			8WA1865	1 50 units	1BT	
8WA1865						
Insulation plates, for terminal sizes 2.5 ... 6 mm²						
			8WA1825	1 50 units	1BT	
8WA1825						
Connection bars						
Versions						
<ul style="list-style-type: none"> • For upper tier of 2-pole terminals <ul style="list-style-type: none"> - For two terminals - For three terminals - For four terminals - For ten terminals • For lower tier of 1 and 2-pole terminals <ul style="list-style-type: none"> - For two terminals - For ten terminals 						
			8WA1850	1 50 units	1BT	
			8WA1851	1 50 units	1BT	
			8WA1852	1 20 units	1BT	
			8WA1853	1 10 units	1BT	
			8WA1835	1 50 units	1BT	
			8WA1838	1 10 units	1BT	
Barriers						
			8WA1823	1 25 units	1BT	
8WA1823						

Design

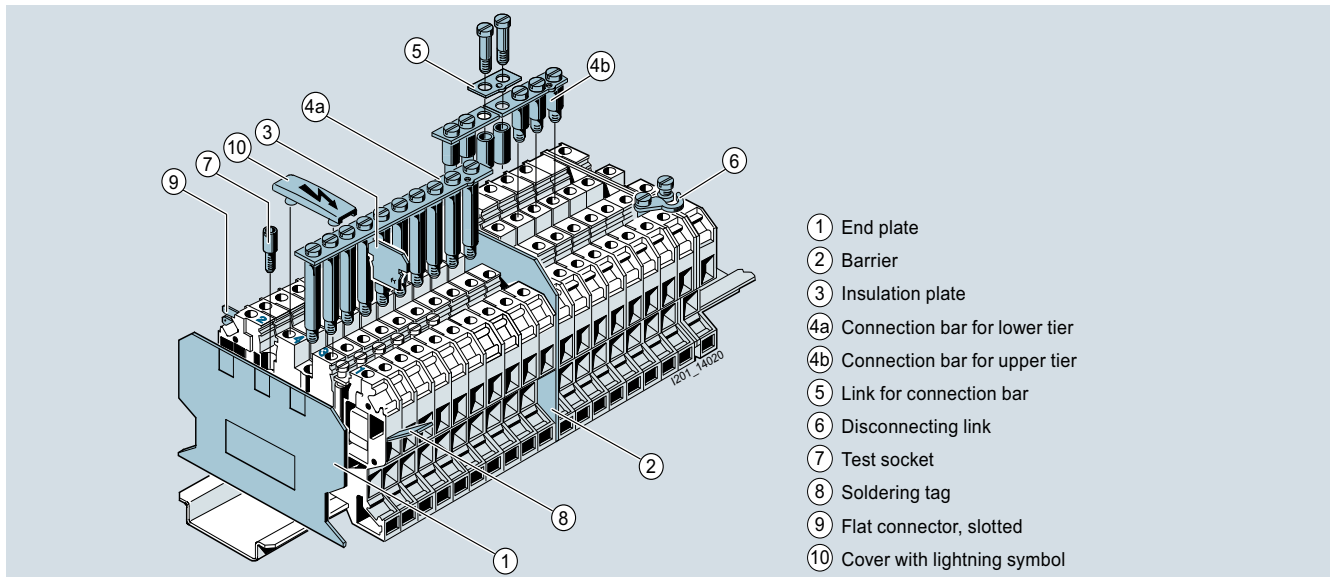

Selection and ordering data

Version	SD	Article No. www.siemens.com/ product?Article No.	Price per PU	PU (UNIT, SET, M)	PS	PG
	d					
General details <ul style="list-style-type: none"> Thermoplastic insulating body Screw terminal at both ends Open on one side Beige 						
Note		Section	Page			
For labeling accessories, see ...		Accessories	14/175			

Terminal size 4 mm²

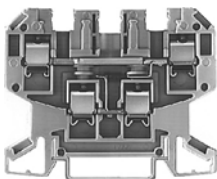





8WA1011-6EG20

Diode terminals, terminal size 4 mm²

- Rated insulation voltage 250 V
- Mounting width 6.5 mm
- Terminal height 45 mm
- Terminal length 64 mm
- AWG 18 ... 10
- Jumpering not supported

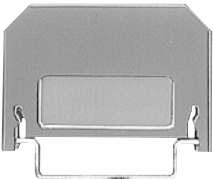
Type	Article No.	PU	PS	PG
<ul style="list-style-type: none"> Rated uninterrupted current 32/1 A 	8WA1011-6EG20	1 10 units	1BT	
<ul style="list-style-type: none"> Rated uninterrupted current 1 A 	8WA1011-6EG22	1 10 units	1BT	
<ul style="list-style-type: none"> Rated uninterrupted current 32/1 A 	8WA1011-6EG23	1 10 units	1BT	
<ul style="list-style-type: none"> Rated uninterrupted current 32/1 A 	8WA1011-6EG24	1 10 units	1BT	
Accessories		Section	Page	
End plates, for two-tier terminals		Accessories	14/164	
	8WA1817	1 50 units	1BT	

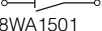
Selection and ordering data



Version	SD	Article No. www.siemens.com/ product?Article No.	Price per PU	PU (UNIT, SET, M)	PS	PG	
d							
General details <ul style="list-style-type: none"> Thermoplastic insulating body Enclosed at both ends 							
Note	Section	Page					
For labeling accessories, see ...	Accessories	14/175					
Terminal size 2.5 mm²							
 <p>8WA1011-1EF20</p>  <p>8WA1011-1EF20</p>		Diode terminals, terminal size 2.5 mm² <ul style="list-style-type: none"> Rated insulation voltage 250 V U_{RRM} Mounting width 6 mm Terminal height 26 mm Terminal length 41 mm Screw terminals at both ends with test options for Ø 2.3 mm test plug Rated uninterrupted current 1 A Peak blocking voltage 1000 V 		8WA1011-1EF20		1 5 units 1BT	
Accessories		Section	Page				
<ul style="list-style-type: none"> Barriers, for terminal sizes 1.5 ... 4 mm² 		Accessories	14/165	8WA1820			1 50 units 1BT
 <p>8WA1501</p>  <p>8WA1501</p>		Through-type terminals, terminal size 2.5 mm² with sectionalizing feature <ul style="list-style-type: none"> Rated uninterrupted current 10 A Rated insulation voltage 380 V AC, 450 V DC (with alternate outgoing soldering tags) <ul style="list-style-type: none"> Open isolating distance 380 V AC, 450 V DC For use of barriers up to 750 V AC, 900 V DC Mounting width 6 mm Terminal height 29 mm Terminal length 41 mm With 2 holes for Ø 2.3 mm test plug With screw terminals at both ends 		8WA1501		1 10 units 1BT	
Note Through-type terminals with sectionalizing feature allow easy isolation of the current path without disconnection of conductors. The sockets of the terminal screws allow actions, such as the measuring of the loop resistance or connection of an ammeter to the circuit. The use of connecting combs reduces the conductor cross-section by one level.							
Accessories		Section	Page				
<ul style="list-style-type: none"> Barriers, for terminal sizes 1.5 ... 4 mm² 		Accessories	14/165	8WA1820			1 50 units 1BT
Accessories							
 <p>8WA1820</p>		Barriers, for terminal sizes 1.5 ... 4 mm²		8WA1820		1 50 units 1BT	

Terminal Blocks

8WA1 Screw Terminals

8WA terminals for components

Selection and ordering data

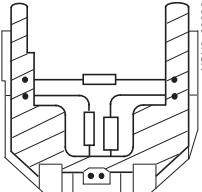
Version	SD	Article No. www.siemens.com/ product?Article No.	Price per PU	PU (UNIT, SET, M)	PS	PG						
	d											
General details <ul style="list-style-type: none"> • Terminals for components • Screw terminal at both ends for 2 conductors each • Plugs with PCB for components • Enclosed at both ends <table border="1"> <thead> <tr> <th>Note</th> <th>Section</th> <th>Page</th> </tr> </thead> <tbody> <tr> <td>For labeling accessories, see ...</td> <td>Accessories</td> <td>14/175</td> </tr> </tbody> </table>							Note	Section	Page	For labeling accessories, see ...	Accessories	14/175
Note	Section	Page										
For labeling accessories, see ...	Accessories	14/175										
Terminal size 1.5 mm²												
 <p>8WA1011-1EE00</p>		Terminals for components, terminal size 1.5 mm² (enclosure only) <ul style="list-style-type: none"> • Rated uninterrupted current 6.3 A • Rated insulation voltage 500 V • Mounting width 10 mm • Terminal height 40 mm • Terminal length 57 mm • For self-fitting with components • To next terminal, determined internally through customer's components 		8WA1011-1EE00		1 5 units 1BT						
 <p>8WA1822-7EE00</p>		Plugs for components, terminal size 1.5 mm² <ul style="list-style-type: none"> • Rated uninterrupted current 6.3 A • Rated insulation voltage 500 V • Mounting width 10 mm • Plug height 29 mm • Plug length 41 mm • With PCB and inscription label (20 × 9 mm) 		8WA1822-7EE00		1 1 unit 1BT						
 <p>Plugs, fully equipped, example</p>												

Dimensional drawings

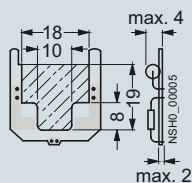

Space for components

Overview

8WA1011-1SF12 fuse terminals are used to protect control circuits against short-circuits.

The fuse terminals are intended for 5 × 20 mm and 5 × 25 mm G fuse links up to 6.3 A and 250 V and for isolating blades up to 16 A and 800 V and have a mounting for a replacement fuse link.

The fuse terminals are suitable for fuse links, sizes ¼" × 1", ¼" × 1¼" (6.3 × 32 mm) up to 6.3 A and 250 V.

Fuse terminals are positive opening fuse-disconnectors.



The fuse links must be replaced at zero voltage. Finger safety is ensured in both closed and open positions.

The LED indicates the status of the disconnected fuse (residual current from 2 mA to 5 mA), but not if the plug is removed (floating).

The double connection is designed so that two conductors with different cross-sections can also be securely connected.

The fixing base of the G fuse terminal allows both centered and recessed mounting, allowing the unhindered routing of a 6 × 6 mm N-busbar. The G fuse terminal can therefore be joined into a single group with the other terminals of a branch.

Selection and ordering data

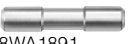

Version	SD	Article No. www.siemens.com/ product?Article No.	Price per PU	PU (UNIT, SET, M)	PS	PG
	d					
General details						
<ul style="list-style-type: none"> With thermoplastic insulating body Screw terminal at both ends for 2 conductors each Enclosed at both ends 						
Note	Section	Page				
For labeling accessories, see ...	Accessories	14/175				
Terminal size 1.5 mm²						
Fuse terminals, terminal size 1.5 mm²						
<ul style="list-style-type: none"> Rated uninterrupted current 6.3 A when using fuses Rated uninterrupted current 16 A when using the isolating blade Rated uninterrupted voltage 250 V when using fuses Rated insulation voltage 800 V when using the isolating blade Mounting width 10 mm Terminal height 42 mm Terminal length 57 mm Open isolating distance 500 V AWG 18 ... 14 AWG 18 ... 14 						
Versions						
<ul style="list-style-type: none"> For G-fuse <ul style="list-style-type: none"> Without LED With LED 24 V AC/DC With LED 230 V AC/DC For inch fuse <ul style="list-style-type: none"> Without LED With LED 24 V AC/DC With LED, 120 V AC/110 V DC 						
			8WA1011-1SF12	1 10 units	1BT	
			8WA1011-1SF13	1 10 units	1BT	
			8WA1011-1SF15	1 10 units	1BT	
			8WA1011-1SF30	1 10 units	1BT	
			8WA1011-1SF31	1 10 units	1BT	
			8WA1011-1SF32	1 10 units	1BT	
Accessories						
						
G fuse links						
DIN 41660						
Versions						
<ul style="list-style-type: none"> Quick-response, high breaking capacity <ul style="list-style-type: none"> Rated uninterrupted current 1 A Rated uninterrupted current 1.6 A Rated uninterrupted current 2.5 A Rated uninterrupted current 4 A Rated uninterrupted current 6.3 A Slow-response, low breaking capacity <ul style="list-style-type: none"> Rated uninterrupted current 1 A Rated uninterrupted current 1.6 A Rated uninterrupted current 2.5 A Rated uninterrupted current 4 A Rated uninterrupted current 6.3 A 						
			8WA1822-7EF16	1 10 units	1BT	
			8WA1822-7EF18	1 10 units	1BT	
			8WA1822-7EF21	1 10 units	1BT	
			8WA1822-7EF23	1 10 units	1BT	
			8WA1822-7EF25	1 10 units	1BT	
			8WA1822-7EF76	1 10 units	1BT	
			8WA1822-7EF78	1 10 units	1BT	
			8WA1822-7EF81	1 10 units	1BT	
			8WA1822-7EF83	1 10 units	1BT	
			8WA1822-7EF85	1 10 units	1BT	
			8WA1891	1 10 units	1BT	
Isolating blades						
5 × 25 mm						

Terminal Blocks

8WA1 Screw Terminals

8WA through-type terminals with soldered and plug-in connection

Selection and ordering data

Version	SD	Article No. www.siemens.com/ product?Article No.	Price per PU	PU (UNIT, SET, M)	PS	PG			
	d								
General details <ul style="list-style-type: none"> With thermoplastic insulating body Enclosed at both ends 									
Note		Section	Page						
For labeling accessories, see ...		Accessories	14/175						
Accessories									
Covers									
Versions									
 8WA1811	<ul style="list-style-type: none"> With lightning symbol - For terminal sizes 1 ... 2,5 mm² - For terminal size 6 mm² 								
	<ul style="list-style-type: none"> White, facility for labeling - For terminal sizes 1 ... 2,5 mm² - For terminal size 6 mm² 								
	8WA1810 8WA1811						1	50 units	1BT
	8WA1860 8WA1862						1	50 units	1BT
 8WA1822-7VH12	Connection bars, for through-type terminals, terminal size 6 mm², with plug-in connection								
	Versions								
<ul style="list-style-type: none"> For two terminals For ten terminals 		8WA1822-7VH12 8WA1822-7VH20	1	50 units	1BT				
 8WA1821	Barriers								
	Versions								
<ul style="list-style-type: none"> For terminal sizes 1.5 ... 4 mm² For terminal sizes 6 ... 16 mm² 		8WA1820 8WA1821	1	50 units	1BT				

Overview

Measuring transformer terminals can be used for testing and isolating circuits in switchboards, control rooms, etc. without interrupting operation.

The isolating and instrument isolating terminals contain an isolating device in the through-type connection. The isolating device permits electrical separation between the input and output of a terminal.

Test sockets for plugs with a diameter of 4 mm can be screwed into the front side of the through-type and isolating terminals. The rated insulation voltage between colored test sockets is 125 V. The rated insulation voltage between test sockets and connection bars not connected to the terminal is 16 V (circuit 3, terminals 3 and 5).

Two adjacent terminals can be connected in parallel with the disconnecting link. The disconnecting link can be operated in any position of the isolating device.

Instrument set for one transformer

The instrument set for one transformer makes the basic circuit of the transformer terminal blocks clear. This basic circuit is also included in much larger instrument sets, which is extended by adding on equivalent circuits. Links between the basic circuits provide many kinds of testing facilities, parallel outgoing lines to other measuring devices, connection of test equipment, etc.

Instrument set for three transformers

The simplest version of an instrument set for a three-phase circuit consists of three basic circuits strung together without any continuing links or extensions. Instead of isolating terminals 1, 3 and 5, less expensive through-type terminals can also be used.

On the other hand, it is also possible to use instrument isolating terminals for this purpose so that the terminal versions are all the same.

Instrument set for three transformers with neutral point

The instrument set with a neutral point is an extension of the previous circuit. Four instead of six cables are sufficient for connecting it with the measuring devices. The neutral point is produced on the measuring instruments on the one hand, and using a shortened 8WA1822-7VH10 connection bar on the other. The instrument isolating terminal 1 is connected to the neutral point using a connecting comb.

Note

The introduction of the 8WA1011-1MH10 through-type terminals and their associated disconnecting links has made it considerably easier to configure terminal sets for current transformers. Instead of the 12 isolating or instrument isolating terminals used previously, now only 4 instrument isolating terminals and 3 through-type terminals are required.

Instrument set with test facility

This instrument set represents a significant enhancement over previous types. In normal operation, terminals 2, 5 and 8 are closed. For testing a measuring instrument (e.g. a plotter), these terminals are opened and terminals 3, 6 and 9 are closed in order to feed in a test signal. The transformers first have to be short-circuited with the disconnecting links between terminals 1-2, 4-5 and 7-8. Wire jumpers connect terminals 1, 4 and 7 with the neutral point. It is formed in terminals 10, 11, 12 and 13 with an 8WA1887 connection bar.

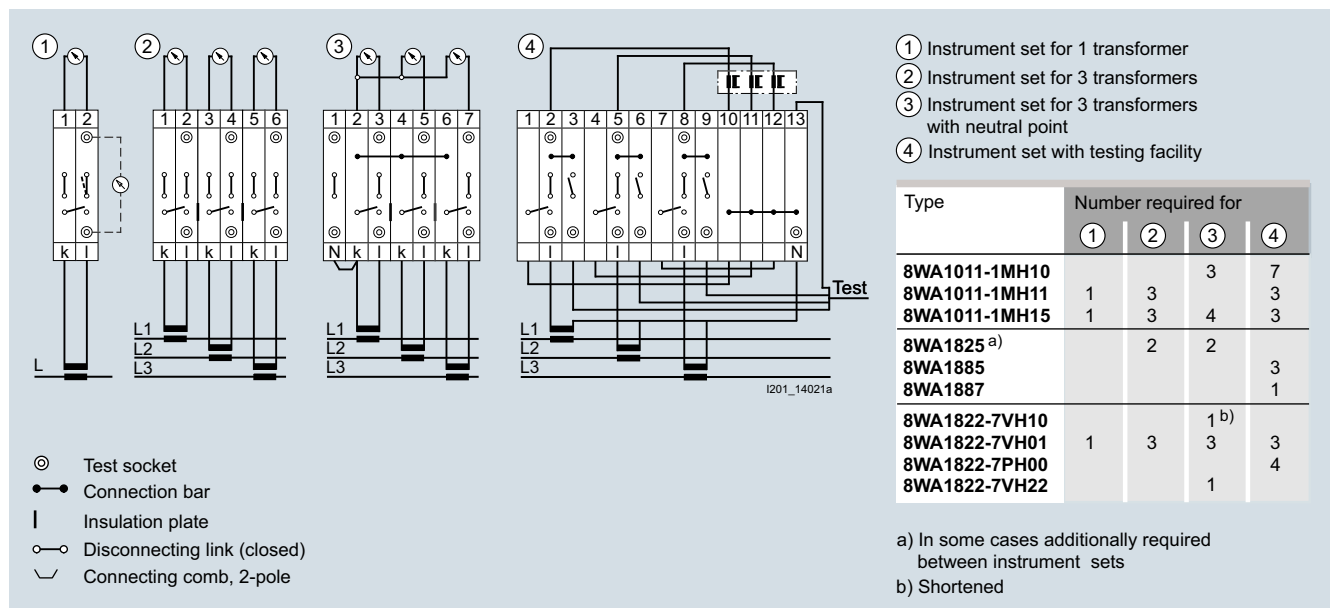



Connection option for measuring transformer terminals (instrument sets)

Terminal Blocks

8WA1 Screw Terminals

8WA measuring transformer terminals

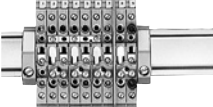
Selection and ordering data

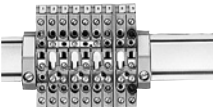
Version	SD	Article No. www.siemens.com/ product?Article No.	Price per PU	PU (UNIT, SET, M)	PS	PG
d						
General details <ul style="list-style-type: none"> With thermoplastic insulating body Screw terminals at both ends and two holes for test sockets for Ø 4 mm test plug, insulated at both ends Enclosed at both ends 						
Note	Section	Page				
For labeling accessories, see ...	Accessories	14/175				
Terminal size 6 mm²						
 <p>8WA1011-1MH10</p>		Through-type terminals, terminal size 6 mm² <ul style="list-style-type: none"> Rated uninterrupted current 41 A Rated insulation voltage 500 V Mounting width 8 mm Terminal height 33 mm Terminal length 83 mm Without test sockets AWG 14 ... 8 AWG 16 ... 10 		8WA1011-1MH10		1 20 units 1BT
 <p>Typical circuit diagram</p>		Accessories				
		Covers, for connection bars	Section	Page		
		• Transparent	Accessories	14/171		
		Test sockets	Accessories	14/171		
		• Rated voltage between test socket and bypassed connection bar: 16 V, recessed	Accessories	14/171		
		Insulation plates, for terminal sizes 2.5 ... 6 mm ²	Accessories	14/171		
		Connecting combs	Accessories	14/171		
		• 10-pole for measuring transformer terminals, can be shortened as required	Accessories	14/171		
		• 2-pole	Accessories	14/171		
		Connection bars, for terminal size 6 mm ²	Accessories	14/171		
		• Two terminals	Accessories	14/171		
		• Three terminals	Accessories	14/171		
		• Four terminals	Accessories	14/171		
		• Ten terminals	Accessories	14/171		
		• Unmounted for ten terminals	Accessories	14/171		
		Barriers, for Insta terminals, terminal size 2.5 mm ² and measuring transformer terminals, terminal size 6 mm ²	Accessories	14/171		
					8WA1822-7AX01 1 10 units 1BT 8WA1822-7PH00 1 50 units 1BT 8WA1825 1 50 units 1BT 8WA7163 1 10 units 1BT 8WA1822-7VH22 1 10 units 1BT 8WA1885 1 50 units 1BT 8WA1886 1 50 units 1BT 8WA1887 1 20 units 1BT 8WA1888 1 10 units 1BT 8WA1822-7VH10 1 50 units 1BT 8WA1822-7TH00 1 50 units 1BT	
 <p>8WA1011-1MH11</p>		Isolating terminals, terminal size 6 mm² <ul style="list-style-type: none"> Rated uninterrupted current 41 A Rated insulation voltage 500 V Mounting width 8 mm Terminal height 33 mm Terminal length 83 mm Without test sockets AWG 14 ... 8 AWG 16 ... 10 		8WA1011-1MH11		1 20 units 1BT
 <p>Typical circuit diagram</p>		Accessories				
		Covers, for connection bars	Section	Page		
		• Transparent	Accessories	14/171		
		• White, facility for labeling	Accessories	14/171		
		Test sockets	Accessories	14/171		
		• Rated voltage between test socket and bypassed connection bar: 16 V, recessed	Accessories	14/171		
		Connecting combs	Accessories	14/171		
		• 10-pole for measuring transformer terminals, can be shortened as required	Accessories	14/171		
		• 2-pole	Accessories	14/171		
		Connection bars, for terminal size 6 mm ²	Accessories	14/171		
		• Two terminals	Accessories	14/171		
		• Three terminals	Accessories	14/171		
		• Four terminals	Accessories	14/171		
		• Ten terminals	Accessories	14/171		
		• Unmounted for ten terminals	Accessories	14/171		
		Barriers, for Insta terminals, terminal size 2.5 mm ² and measuring transformer terminals, terminal size 6 mm ²	Accessories	14/171		
					8WA1822-7AX01 1 10 units 1BT 8WA1822-7AX03 1 10 units 1BT 8WA1822-7PH00 1 50 units 1BT 8WA7163 1 10 units 1BT 8WA1822-7VH22 1 10 units 1BT 8WA1885 1 50 units 1BT 8WA1886 1 50 units 1BT 8WA1887 1 20 units 1BT 8WA1888 1 10 units 1BT 8WA1822-7VH10 1 50 units 1BT 8WA1822-7TH00 1 50 units 1BT	

Terminal Blocks

8WA2 Spring-Loaded Terminals

8WA initiator/actuator terminals

Overview

- Fast and cost-effective connection of signal transmitters to the controller
- Only 5 mm wide but still fitted with connection facility for proximity switches with up to three conductors plus shielding
- Connection is clear, simple and safe due to:
 - Front connection
 - Color coding of clamping points
 - Conductors from only 0.08 ... 1.5 mm² without end sleeves that are secured using spring-loaded terminals
- LEDs make the switch states or the application of voltage easy to see. It is no longer necessary to test with measuring instruments.
- Connection modules cut wiring requirements and time because the potentials of the terminals (L+, L- and S) are automatically connected; there is therefore no need for linking accessories.
- The modules contain a feeder terminal and 8 or 17 initiator/ actuator terminals and can be snapped or screwed onto 35 mm standard mounting rails

The feeder terminals are fitted with an additional negative outgoing feeder which can be used to supply isolated digital input/output modules. The frame (M) can therefore be bridged by means of the terminals.

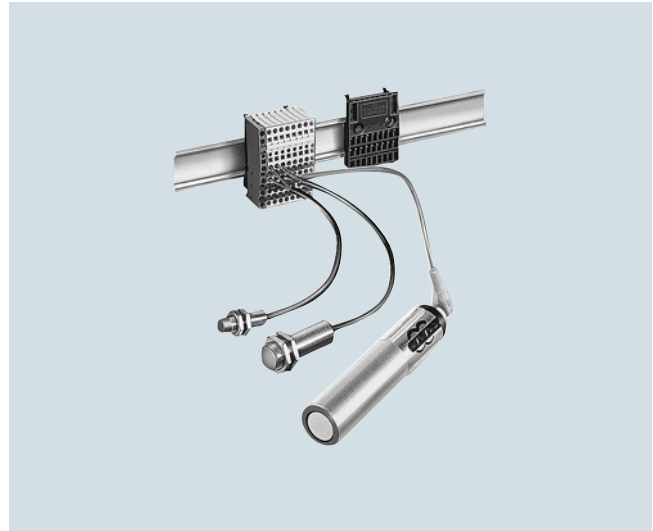

Terminals and connection modules (always order as combined unit)

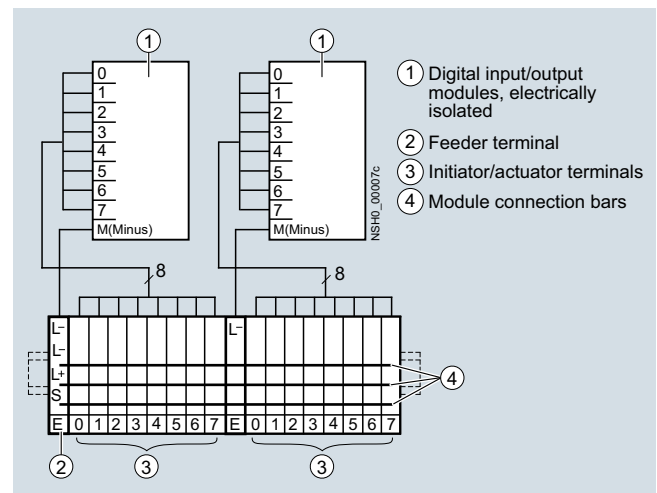

Initiator/actuator terminals with electrically isolated digital input/output modules

Technical specifications

Continuous load at increased ambient temperatures

8WA2 terminal blocks can be loaded with their full uninterrupted current at ambient temperatures of up to +55 °C. At higher ambient temperatures, a current reduction according to the following formula is required:

$$I_{th2} = I_{th1} \cdot k$$

I_{th1} = Uninterrupted current according to selection tables, relative to the nominal cross-section

I_{th2} = Uninterrupted current at increased ambient temperature

k = Derating factor according to table

Ambient temperature	Derating factor k
60 °C	0.94
65 °C	0.88
70 °C	0.82
75 °C	0.75
80 °C	0.67
85 °C	0.58
90 °C	0.47
95 °C	0.33

The maximum permissible clamping point overtemperature of 45 K according to IEC 60947-7-1 and EN 60947-7-1, Part 1, is not exceeded at ambient temperatures up to 100 °C.

Clamping points

Terminal size	Type	Thread diameter of terminal screws	Screwdriver blades acc. to DIN 5264 8WA2803 or 8WA2804	Tightening torque = test torque	Tensile forces acc. to IEC 60947-1 at max. conductor connection	Stripped length
mm ²				Nm	N	mm
1.5	8WA2011-3KE	--	0.5 × 3.5	--	40	8 ... 9

Single-conductor connection

Terminal size	Type	Smallest conductor cross-section					Largest conductor cross-section				
		Solid	Stranded	Finely stranded	Finely stranded with end sleeve		Solid	Stranded	Finely stranded	Finely stranded with end sleeve	
mm ²		mm ²	mm ²	mm ²	mm ²	Size	mm ²	mm ²	mm ²	mm ²	Size
1.5	8WA2011-3KE . .	0.08	0.5	0.2	--	--	1.5	1.5	1.5	--	--

® and ⚡ ratings



Terminal size	Type	CSA rating AWG	Rated current		UR rating AWG	Rated current		Rated voltage U_e V
			I_n A	I_n A		I_n A	I_n A	
1.5	8WA2011-3KE	28 ... 16	10	65	22 ... 16	10	65	65

Terminal Blocks

8WA2 Spring-Loaded Terminals

8WA initiator/actuator terminals

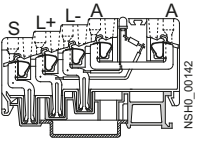
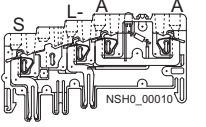
Selection and ordering data

Version	SD	Article No. www.siemens.com/ product?Article No.	Price per PU	PU (UNIT, SET, M)	PS	PG																																							
d																																													
General details <ul style="list-style-type: none"> • Thermoplastic insulating body • Front connection with spring-loaded terminal • L+ = brown S (shield) = green • L- = blue A (output), connection not colored • Enclosed at both ends 																																													
<table border="1"> <thead> <tr> <th>Note</th> <th>Section</th> <th>Page</th> </tr> </thead> <tbody> <tr> <td>For labeling accessories, see ...</td> <td>8WA accessories</td> <td>14/175</td> </tr> </tbody> </table>							Note	Section	Page	For labeling accessories, see ...	8WA accessories	14/175																																	
Note	Section	Page																																											
For labeling accessories, see ...	8WA accessories	14/175																																											
Terminal size 1.5 mm²																																													
 <p>8WA2011-3KE00</p>																																													
Feeder terminal, terminal size 1.5 mm² <ul style="list-style-type: none"> • Orange • Rated uninterrupted current 10 A • Rated insulation voltage 65 V • Mounting width 5 mm • For 250 V, pollution degree 2 																																													
<table border="1"> <thead> <tr> <th>Versions</th> <th></th> <th></th> <th></th> <th></th> <th></th> <th></th> </tr> </thead> <tbody> <tr> <td rowspan="3"> <ul style="list-style-type: none"> • PNP - L+, L-, S, without LED - L+, L-, without LED - L+, L-, S, with green LED, 15 ... 30 V </td> <td>8WA2011-3KE00</td> <td>1</td> <td>20 units</td> <td>1BT</td> <td></td> <td></td> </tr> <tr> <td>8WA2011-3KE01</td> <td>1</td> <td>20 units</td> <td>1BT</td> <td></td> <td></td> </tr> <tr> <td>8WA2011-3KE02</td> <td>1</td> <td>20 units</td> <td>1BT</td> <td></td> <td></td> </tr> <tr> <td rowspan="2"> <ul style="list-style-type: none"> • NPN - L+, L-, S, without LED - L+, L-, without LED, without ground connection </td> <td>8WA2011-3KE00</td> <td>1</td> <td>20 units</td> <td>1BT</td> <td></td> <td></td> </tr> <tr> <td>8WA2011-3KE01</td> <td>1</td> <td>20 units</td> <td>1BT</td> <td></td> <td></td> </tr> </tbody> </table>							Versions							<ul style="list-style-type: none"> • PNP - L+, L-, S, without LED - L+, L-, without LED - L+, L-, S, with green LED, 15 ... 30 V 	8WA2011-3KE00	1	20 units	1BT			8WA2011-3KE01	1	20 units	1BT			8WA2011-3KE02	1	20 units	1BT			<ul style="list-style-type: none"> • NPN - L+, L-, S, without LED - L+, L-, without LED, without ground connection 	8WA2011-3KE00	1	20 units	1BT			8WA2011-3KE01	1	20 units	1BT		
Versions																																													
<ul style="list-style-type: none"> • PNP - L+, L-, S, without LED - L+, L-, without LED - L+, L-, S, with green LED, 15 ... 30 V 	8WA2011-3KE00	1	20 units	1BT																																									
	8WA2011-3KE01	1	20 units	1BT																																									
	8WA2011-3KE02	1	20 units	1BT																																									
<ul style="list-style-type: none"> • NPN - L+, L-, S, without LED - L+, L-, without LED, without ground connection 	8WA2011-3KE00	1	20 units	1BT																																									
	8WA2011-3KE01	1	20 units	1BT																																									
 <p>8WA2011-3KE13 initiator terminals with connection module</p>																																													
Initiator terminals, terminal size 1.5 mm² <ul style="list-style-type: none"> • Light gray • Rated uninterrupted current 10 A • Rated insulation voltage 65 V • Mounting width 5 mm • For 250 V, pollution degree 2 • Current consumption with LED 4.8 mA • PNP 																																													
<table border="1"> <thead> <tr> <th>Versions</th> <th></th> <th></th> <th></th> <th></th> <th></th> <th></th> </tr> </thead> <tbody> <tr> <td rowspan="3"> <ul style="list-style-type: none"> • L+, L-, A, without LED • L+, L-, S, A, without LED • L+, L-, A, with yellow LED, 15 ... 30 V • L+, L-, S, A, with yellow LED, 15 ... 30 V </td> <td>8WA2011-3KE10</td> <td>1</td> <td>20 units</td> <td>1BT</td> <td></td> <td></td> </tr> <tr> <td>8WA2011-3KE11</td> <td>1</td> <td>20 units</td> <td>1BT</td> <td></td> <td></td> </tr> <tr> <td>8WA2011-3KE12</td> <td>1</td> <td>20 units</td> <td>1BT</td> <td></td> <td></td> </tr> <tr> <td></td> <td>8WA2011-3KE13</td> <td>1</td> <td>20 units</td> <td>1BT</td> <td></td> <td></td> </tr> </tbody> </table>							Versions							<ul style="list-style-type: none"> • L+, L-, A, without LED • L+, L-, S, A, without LED • L+, L-, A, with yellow LED, 15 ... 30 V • L+, L-, S, A, with yellow LED, 15 ... 30 V 	8WA2011-3KE10	1	20 units	1BT			8WA2011-3KE11	1	20 units	1BT			8WA2011-3KE12	1	20 units	1BT				8WA2011-3KE13	1	20 units	1BT								
Versions																																													
<ul style="list-style-type: none"> • L+, L-, A, without LED • L+, L-, S, A, without LED • L+, L-, A, with yellow LED, 15 ... 30 V • L+, L-, S, A, with yellow LED, 15 ... 30 V 	8WA2011-3KE10	1	20 units	1BT																																									
	8WA2011-3KE11	1	20 units	1BT																																									
	8WA2011-3KE12	1	20 units	1BT																																									
	8WA2011-3KE13	1	20 units	1BT																																									
 <p>8WA2011-3KE33 actuator terminals with LED</p>																																													
Actuator terminals, terminal size 1.5 mm² <ul style="list-style-type: none"> • Light gray • Rated uninterrupted current 10 A • Rated insulation voltage 65 V • Mounting width 5 mm • For 250 V, pollution degree 2 • Current consumption with LED 4.8 mA 																																													
<table border="1"> <thead> <tr> <th>Versions</th> <th></th> <th></th> <th></th> <th></th> <th></th> <th></th> </tr> </thead> <tbody> <tr> <td rowspan="2"> <ul style="list-style-type: none"> • PNP - L-, S, A, without LED - L-, S, A, with yellow LED, 15 ... 30 V </td> <td>8WA2011-3KE31</td> <td>1</td> <td>20 units</td> <td>1BT</td> <td></td> <td></td> </tr> <tr> <td>8WA2011-3KE33</td> <td>1</td> <td>20 units</td> <td>1BT</td> <td></td> <td></td> </tr> <tr> <td> <ul style="list-style-type: none"> • NPN - L+, S, A, without LED </td> <td>8WA2011-3KE30</td> <td>1</td> <td>20 units</td> <td>1BT</td> <td></td> <td></td> </tr> </tbody> </table>							Versions							<ul style="list-style-type: none"> • PNP - L-, S, A, without LED - L-, S, A, with yellow LED, 15 ... 30 V 	8WA2011-3KE31	1	20 units	1BT			8WA2011-3KE33	1	20 units	1BT			<ul style="list-style-type: none"> • NPN - L+, S, A, without LED 	8WA2011-3KE30	1	20 units	1BT														
Versions																																													
<ul style="list-style-type: none"> • PNP - L-, S, A, without LED - L-, S, A, with yellow LED, 15 ... 30 V 	8WA2011-3KE31	1	20 units	1BT																																									
	8WA2011-3KE33	1	20 units	1BT																																									
<ul style="list-style-type: none"> • NPN - L+, S, A, without LED 	8WA2011-3KE30	1	20 units	1BT																																									
 <p>8WA2011-3KE50</p>																																													
Connection modules, terminal size 1.5 mm², for all PNP and NPN terminals <ul style="list-style-type: none"> • Black • Rated uninterrupted current 10 A • Rated insulation voltage 65 V • Mounting width 5 mm • For 250 V, pollution degree 2 • L+, L-, S integrated 																																													
<table border="1"> <thead> <tr> <th>Versions</th> <th></th> <th></th> <th></th> <th></th> <th></th> <th></th> </tr> </thead> <tbody> <tr> <td> <ul style="list-style-type: none"> • For 8 initiator/actuator terminals and one feeder terminal - Width 47 mm - Height 65 mm </td> <td>8WA2011-3KE50</td> <td>1</td> <td>10 units</td> <td>1BT</td> <td></td> <td></td> </tr> <tr> <td> <ul style="list-style-type: none"> • For 16 initiator/actuator terminals, one feeder terminal and space for one terminal for further bridging for subsequent module - Width 93 mm - Height 65 mm </td> <td>8WA2011-3KE51</td> <td>1</td> <td>5 units</td> <td>1BT</td> <td></td> <td></td> </tr> </tbody> </table>							Versions							<ul style="list-style-type: none"> • For 8 initiator/actuator terminals and one feeder terminal - Width 47 mm - Height 65 mm 	8WA2011-3KE50	1	10 units	1BT			<ul style="list-style-type: none"> • For 16 initiator/actuator terminals, one feeder terminal and space for one terminal for further bridging for subsequent module - Width 93 mm - Height 65 mm 	8WA2011-3KE51	1	5 units	1BT																				
Versions																																													
<ul style="list-style-type: none"> • For 8 initiator/actuator terminals and one feeder terminal - Width 47 mm - Height 65 mm 	8WA2011-3KE50	1	10 units	1BT																																									
<ul style="list-style-type: none"> • For 16 initiator/actuator terminals, one feeder terminal and space for one terminal for further bridging for subsequent module - Width 93 mm - Height 65 mm 	8WA2011-3KE51	1	5 units	1BT																																									

Selection and ordering data

Labeling system for individual inscription

Labeling systems for

- Terminal blocks
- Modular installation devices
- Circuit breakers
- Switch disconnectors

Available from:

Murrplastik Systemtechnik GmbH
Postfach 1143
71570 Oppenweiler
Germany
Telephone: +49 7191-482-0
email: info@murrplastik.de

Accessories for labeling system

Version	SD	Article No. www.siemens.com/ product?Article No.	Price per PU	PU (UNIT, SET, M)	PS	PG
Terminal block labels, for labeling system						
Versions						
<ul style="list-style-type: none"> • For 8WA1 and 8WA2, individually removable <ul style="list-style-type: none"> - 5 x 7, white (WIN 68) - 5 x 10, white (WIN 68) • Not for two-tier terminals (bottom tier); flat terminals: 8WA1010-1PQ00, 8WA1808 		8WA8850-2AY 8WA8851-2AY		100	1020 units	1BT
				100	1020 units	1BT
Snap-on device labels						
For identification of, e.g.						
<ul style="list-style-type: none"> • Circuit breakers • Contactors • Control systems 						
Versions						
<ul style="list-style-type: none"> • 20 x 7, white, snap-on hooks at side (WIN 95) • 20 x 7, turquoise, snap-on hooks at side (WIN 95) 		8WH8210-0AA55 8WH8210-0AA56		100	340 units	1BT
				100	340 units	1BT
Adhesive device labels						
For identification of, e.g.						
<ul style="list-style-type: none"> • Modular installation devices • Switch disconnectors 						
Versions						
<ul style="list-style-type: none"> • 15 x 6 mm, white (WIN 098) • 15 x 6 mm, yellow (WIN 099) • 19 x 8 mm, white (WIN 088) • 19 x 8 mm, yellow (WIN 082) 		8WH8210-0AA35 8WH8210-0AA36 8WH8210-0AA45 8WH8210-0AA46		100	3740 units	1BT
				100	3740 units	1BT
				100	2700 units	1BT
				100	2700 units	1BT

Note:

The inscription labels can be inscribed with Murrplastik labeling systems or by hand.

The WIN designation facilitates assignment in the inscription software.

Terminal Blocks

Accessories for 8WA Terminal Blocks

Standard labeling system

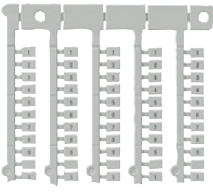
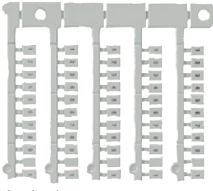
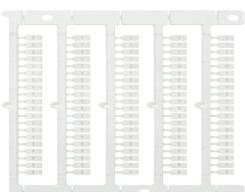
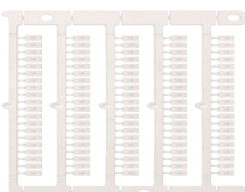

Selection and ordering data

Version	SD	Article No. www.siemens.com/ product?Article No.	Price per PU	PU (UNIT, SET, M)	PS	PG
d						
Labels, blank <ul style="list-style-type: none"> Suitable for plotting 						
Versions <ul style="list-style-type: none"> Label size 5 × 7 mm (WIN 68) Label size 5 × 10 mm (WIN 68) 		8WA8348-2AY 8WA8310-2AY		100	136 units	1BT
Labels, with inscription <ul style="list-style-type: none"> Label size 5 × 7 mm Font height 2 mm 						
Versions <ul style="list-style-type: none"> Horizontal Vertical 		8WA8360-□□□ 8WA8361-□□□		100	204 units	1BT
Inscription <ul style="list-style-type: none"> 1...5, 3 cards each with [(13 x (1...5)) + (1 x (1...3))] 1...9, 3 cards each with [(7 x (1...9)) + (1 x (1...5))] (only available as 8WA8361-0AA) 6...10, 3 cards each with [(13 x (6...10)) + (1 x (6...8))] 11...15, 3 cards each with [(13 x (11...15)) + (1 x (11...13))] 16...20, 3 cards each with [(13 x (16...20)) + (1 x (16...18))] 21...25, 3 cards each with [(13 x (21...25)) + (1 x (21...23))] 26...30, 3 cards each with [(13 x (26...30)) + (1 x (26...28))] 31...35, 3 cards each with [(13 x (31...35)) + (1 x (31...33))] 36...40, 3 cards each with [(13 x (36...40)) + (1 x (36...38))] 41...45, 3 cards each with [(13 x (41...45)) + (1 x (41...43))] 46...50, 3 cards each with [(13 x (46...50)) + (1 x (46...48))] 51...55, 3 cards each with [(13 x (51...55)) + (1 x (51...53))] (only available as 8WA8361-0BL) 56...60, 3 cards each with [(13 x (56...60)) + (1 x (56...58))] 61...65, 3 cards each with [(13 x (61...65)) + (1 x (61...63))] 66...70, 3 cards each with [(13 x (66...70)) + (1 x (66...68))] (only available as 8WA8361-0BP) 71...75, 3 cards each with [(13 x (71...75)) + (1 x (71...73))] 76...80, 3 cards each with [(13 x (76...80)) + (1 x (76...78))] 81...85, 3 cards each with [(13 x (81...85)) + (1 x (81...83))] 86...90, 3 cards each with [(13 x (86...90)) + (1 x (86...88))] (only available as 8WA8361-0BT) 91...95, 3 cards each with [(13 x (91...95)) + (1 x (61...93))] 96...100, 3 cards each with [(13 x (96...100)) + (1 x (96...98))] 1...20, 3 cards each with 3 x (1...20) + 1 x (1...8) 1...40, 3 cards each with [(1 x (1...40)) + (1 x (1...28))] 41...100, 3 cards each with [(1 x (41...100)) + 1 x (41...48)] 101...200, 3 cards, 2 x (101...200) + 1 x (101...104) 201...300, 3 cards, 2 x (201...300) + 1 x (201...204) 1...100, 3 cards, 2 x (1...100) + 1 x (1...4) A...T, 3 cards each with [(3 x (A...T)) + (1 x (A...H))] U, V, W, X, Y, Z, +, -, 3 cards each with [(8 x (U...)) + (1 x (U...X))] L1, L2, L3, N, PE, 3 cards each with [(9 x (L1...PE)) + (1 x (L1...L3))] U1, V1, W1, U2, V2, W2 3 cards each with [(11 x (U1...W2)) + (1 x (U1,V1))] 	0BA 0AA 0BB 0BC 0BD 0BE 0BF 0BG 0BH 0BJ 0BK 0BL 0BM 0BN 0BP 0BQ 0BR 0BS 0BT 0BU 0BV 0AB 0AC 0AD 0AF 0AG 0AE 1AA 1AB 1AC 1AD	100	204 units			
 <p>Horizontal (8WA8360-0BA)</p>  <p>Vertical (8WA8361-0BA)</p>						
Labels, type 347/348, with inscription <ul style="list-style-type: none"> Label size 5 × 7 mm Font height 2 mm 						
Versions <ul style="list-style-type: none"> Horizontal Vertical 		8WA8347-□□□ 8WA8348-□□□		100	136 units	
Inscription <ul style="list-style-type: none"> L1 L2 L3 N MP (only available as 8WA8348-2AB) PE L+ L- N X (only available as 8WA8348-1AG) Y (only available as 8WA8348-1AH) 		2AC 2AD 2AE 1AR 2AB 2AH 2AF 2AG 1AR 1AG 1AH		100	136 units	
 <p>Horizontal (8WA8347-2AC)</p>  <p>Vertical (8WA8348-2AC)</p>						

Terminal Blocks

Accessories for 8WA Terminal Blocks

Standard labeling system

Version	SD	Article No. www.siemens.com/ product?Article No.	Price per PU	PU (UNIT, SET, M)	PS	PG
	d					
Labels, custom inscriptions <ul style="list-style-type: none"> Label size 5 × 7 mm Font height 2 mm Specify required inscription in plain text 						
Labels, custom inscriptions <ul style="list-style-type: none"> Label size 5 × 7 mm Font height 2 mm Specify required inscription in plain text 						
Versions <ul style="list-style-type: none"> Horizontal Can only be ordered with the order code -ZY01 Vertical, can only be ordered with the order code -ZY01 		8WA8347-OXA -Z and Y01 8WA8348-OXA -Z and Y01		100	136 units	1BT
				100	136 units	1BT
 <p>8WA1806</p>		8WA1806		1	50 units	1BT
End labeling plates <ul style="list-style-type: none"> 21 × 42 mm Paper label, inscription possible, with transparent cover Suitable for 8WA1805, 8WA1808 and 8WA2808 end retainers 						
 <p>8WA8826-OAA horizontal</p>		8WA8826-OAA 8WA8826-OAB 8WA8826-OAC 8WA8212-OAA65		100	380 units	1BT
Terminal strip labels Suitable for 8WA1808 end retainer				100	100 units	1BT
Terminal strip labels Suitable for 8WA1808 end retainer				100	100 units	1BT
Terminal strip labels Suitable for 8WA1808 end retainer				100	100 units	1BT
Terminal strip labels Suitable for 8WA1808 end retainer				100	380 units	1BT

